



Rolling Bearings



Technical Information	Page No. A7	Tech. Info.
Deep Groove Ball Brgs.	B4	
Angular Contact Ball Brgs.	B46	
Self-Aligning Ball Brgs.	B76	
Cylindrical Roller Brgs.	B84	
Tapered Roller Brgs.	B110	
Spherical Roller Brgs.	B182	
Thrust Brgs.	B206	Thrust Brgs.
Needle Roller Brgs.	B244	
Ball Brg. Units	B280	
Plummer Blocks	B304	
Cylindrical Roller Brgs. for Sheaves	B326	Sheaves
Roll-Neck Brgs. (4-Rows) Railway Rolling Stock Brgs.	B334	Roll Neck Railway
Balls and Rollers	B346	
Accessories for Rolling Brgs.	B356	Sleeves 
NSK Products and Appendices	C1	Appendices

Rolling Bearings

CAT. No. E1102m

Introduction to Revised **NSK** Rolling Bearing Catalog (CAT.No.E1102m)

We want to thank you for your interest in this edition of our Rolling Bearing Catalog. It has been revised with our customers in mind, and we hope it fills your needs.

Recently, technology has been advancing at a remarkable pace, and with it has come a host of new products in many fields including computers, office automation, audio-visual equipment, medical equipment, and many others. Accordingly, rolling bearings, which are highly important machine elements, must be designed to satisfy increasingly stringent requirements for higher speeds, greater precision, higher reliability, and other challenging demands.

We edited this Rolling Bearing Catalog to reflect the growing number of NSK products, new developments, and technical progress. In it, you will find a wide range of bearings that will satisfy almost any requirement.

This catalog was revised to reflect the growing number of **NSK** products and certain revisions in **JIS** and **ISO** and to better serve our customers. The first part contains general information about rolling bearings to facilitate selection of the most appropriate type. Next supplementary technical information is provided regarding bearing life, load ratings, limiting speeds, handling and mounting, lubrication, etc. Finally, the catalog presents extensive tables containing most bearing numbers and showing dimensions and pertinent design data listed in the order of increasing bore size. Data in the table are given in both the international Unit System (**SI**) and Engineering Unit System (Gravitational System of Units).

We hope this catalog will allow you to select the optimum bearing for your application. However, if assistance is required, please contact **NSK**, and the company's engineers and computer programs can quickly supply the information you need.

1. TYPES AND FEATURES OF ROLLING BEARINGS

1.1 Design and Classification

Rolling bearings generally consist of two rings, rolling elements, and a cage, and they are classified into radial bearings or thrust bearings depending on the direction of the main load. In addition, depending on the type of rolling elements, they are classified into ball bearings or roller bearings, and they are further segregated by differences in their design or specific purpose. The most common bearing types and nomenclature of bearing parts are shown in Fig.1.1, and a general classification of rolling bearings is shown in Fig. 1.2.

1.2 Characteristics of Rolling Bearings

Compared with plain bearings, rolling bearings have the following major advantages:

- (1) Their starting torque or friction is low and the difference between the starting torque and running torque is small.

- (2) With the advancement of worldwide standardization, rolling bearings are internationally available and interchangeable.
- (3) Maintenance, replacement, and inspection are easy because the structure surrounding rolling bearings is simple.
- (4) Many rolling bearings are capable of taking both radial and axial loads simultaneously or independently.
- (5) Rolling bearings can be used under a wide range of temperatures.
- (6) Rolling bearings can be preloaded to produce a negative clearance and achieve greater rigidity.

Furthermore, different types of rolling bearings have their own individual advantages. The features of the most common rolling bearings are described on Pages A10 to A12 and in Table 1.1 (Pages A14 and A15).

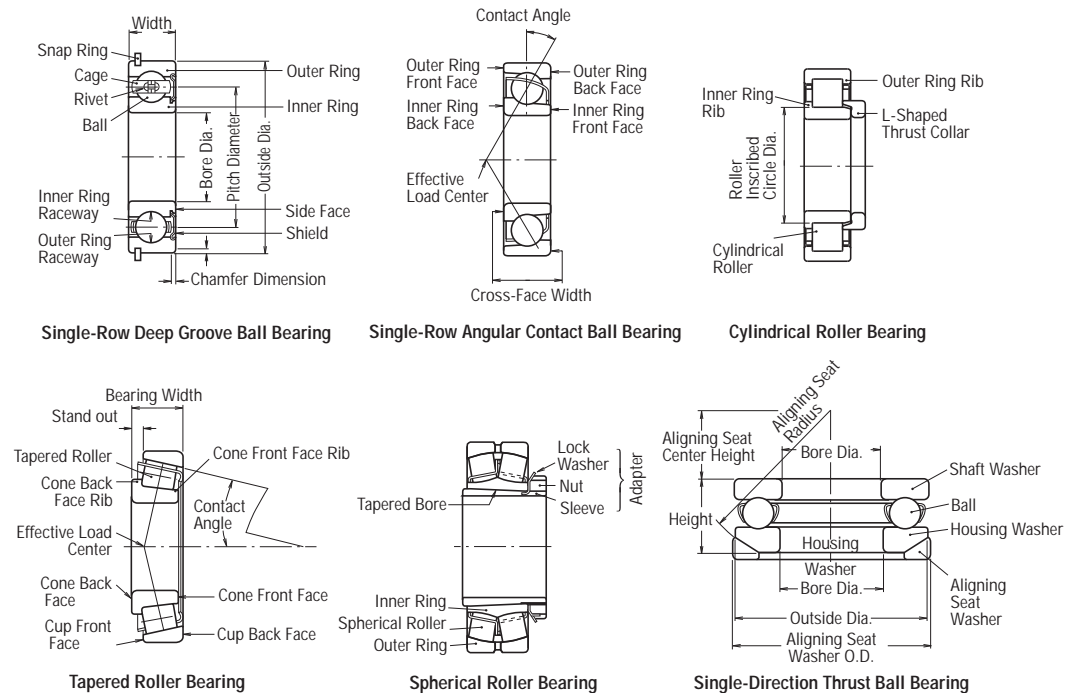

Fig. 1.1 Nomenclature for Bearing Parts

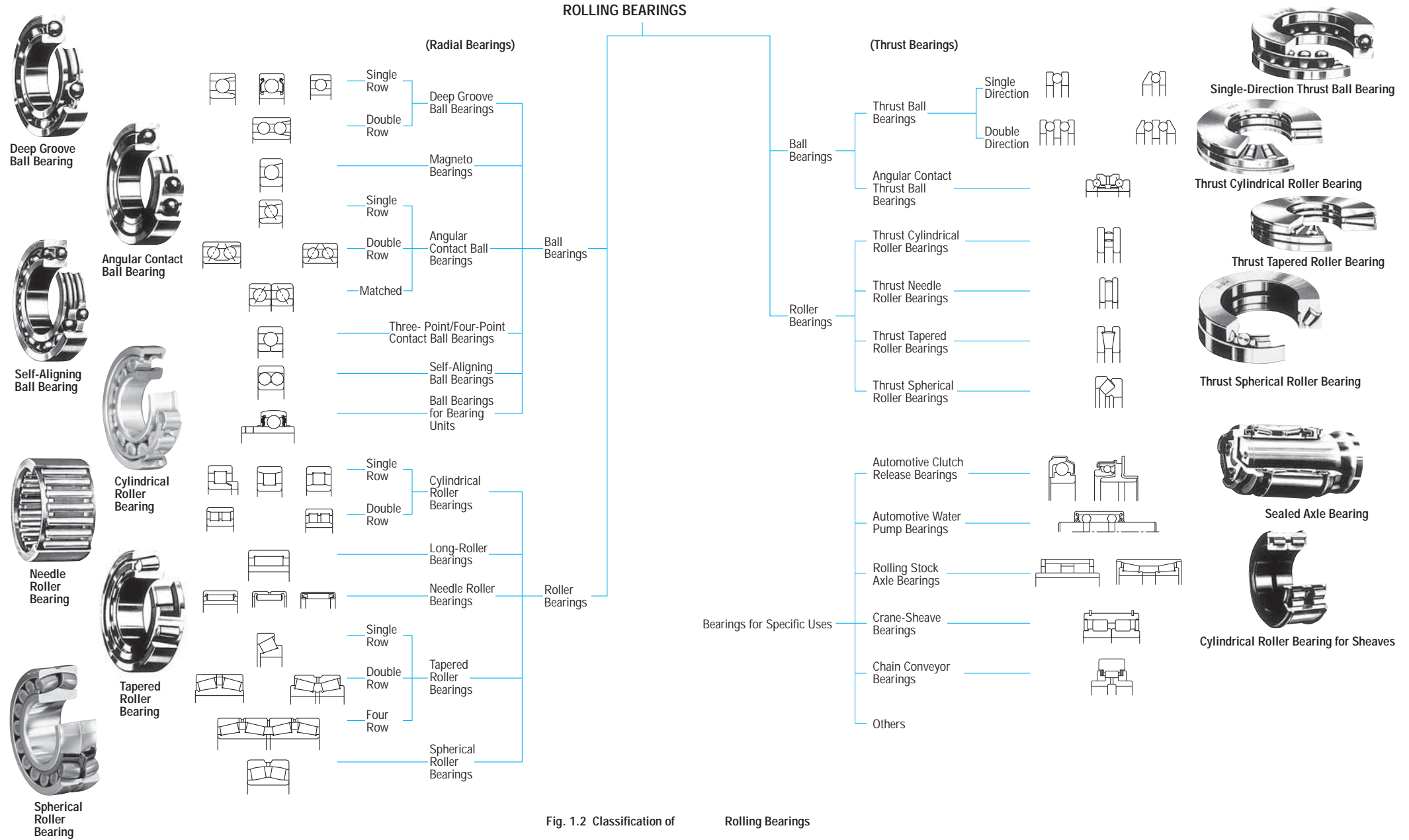
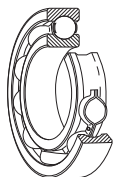

Fig. 1.2 Classification of Rolling Bearings

Single-Row Deep Groove Ball Bearings

Single-row deep groove ball bearings are the most common type of rolling bearings. Their use is very widespread. The raceway grooves on both the inner and outer rings have circular arcs of slightly larger radius than that of the balls. In addition to radial loads, axial loads can be imposed in either direction. Because of their low torque, they are highly suitable for applications where high speeds and low power loss are required.

In addition to open type bearings, these bearings often have steel shields or rubber seals installed on one or both sides and are prelubricated with grease. Also, snap rings are sometimes used on the periphery. As to cages, pressed steel ones are the most common.



Magneto Bearings

The inner groove of magneto bearings is a little shallower than that of deep groove bearings. Since the outer ring has a shoulder on only one side, the outer ring may be removed. This is often advantageous for mounting. In general, two such bearings are used in duplex pairs. Magneto bearings are small bearings with a bore diameter of 4 to 20 mm and are mainly used for small magnetos, gyroscopes, instruments, etc. Pressed brass cages are generally used.

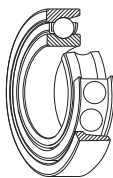

Single-Row Angular Contact Ball Bearings

Individual bearings of this type are capable of taking radial loads and also axial loads in one direction. Four contact angles of 15°, 25°, 30°, and 40° are available. The larger the contact angle, the higher the axial load capacity. For high speed operation, however, the smaller contact angles are preferred. Usually, two bearings are used in duplex pairs, and the clearance between them must be adjusted properly.

Pressed-steel cages are commonly used, however, for high precision bearings with a contact angle less than 30°, polyamide resin cages are often used.

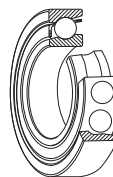

Duplex Bearings

A combination of two radial bearings is called a duplex pair. Usually, they are formed using angular contact ball bearings or tapered roller bearings. Possible combinations include face-to-face, which have the outer ring faces together (type DF), back-to-back (type DB), or both front faces in the same direction (type DT). DF and DB duplex bearings are capable of taking radial loads and axial loads in either direction. Type DT is used when there is a strong axial load in one direction and it is necessary to impose the load equally on each bearing.

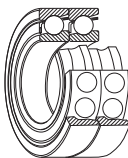

Double-Row Angular Contact Ball Bearings

Double-row angular contact ball bearings are basically two single-row angular contact ball bearings mounted back-to-back except that they have only one inner ring and one outer ring, each having raceways. They can take axial loads in either direction.

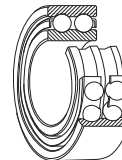

Four-Point Contact Ball Bearings

The inner and outer rings of four-point contact ball bearings are separable because the inner ring is split in a radial plane. They can take axial loads from either direction. The balls have a contact angle of 35° with each ring. Just one bearing of this type can replace a combination of face-to-face or back-to-back angular contact bearings. Machined brass cages are generally used.

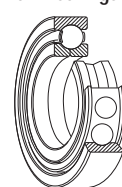

Self-Aligning Ball Bearings

The inner ring of this type of bearing has two raceways and the outer ring has a single spherical raceway with its center of curvature coincident with the bearing axis. Therefore, the axis of the inner ring, balls, and cage can deflect to some extent around the bearing center. Consequently, minor angular misalignment of the shaft and housing caused by machining or mounting error is automatically corrected.

This type of bearing often has a tapered bore for mounting using an adapter sleeve.

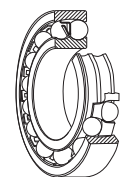

Cylindrical Roller Bearings

In bearings of this type, the cylindrical rollers are in linear contact with the raceways. They have a high radial load capacity and are suitable for high speeds.

There are different types designated NU, NJ, NUP, N, NF for single-row bearings, and NNU, NN for double-row bearings depending on the design or absence of side ribs.

The outer and inner rings of all types are separable.

Some cylindrical roller bearings have no ribs on either the inner or outer ring, so the rings can move axially relative to each other. These can be used as free-end bearings. Cylindrical roller bearings, in which either the inner or outer rings has two ribs and the other ring has one, are capable of taking some axial load in one direction. Double-row cylindrical roller bearings have high radial rigidity and are used primarily for precision machine tools.

Pressed steel or machined brass cages are generally used, but sometimes molded polyamide cages are also used.



Needle Roller Bearings

Needle roller bearings contain many slender rollers with a length 3 to 10 times their diameter. As a result, the ratio of the bearing outside diameter to the inscribed circle diameter is small, and they have a rather high radial load capacity.

There are numerous types available, and many have no inner rings. The drawn-cup type has a pressed steel outer ring and the solid type has a machined outer ring. There are also cage and roller assemblies without rings. Most bearings have pressed steel cages, but some are without cages.

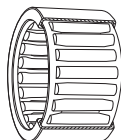

Tapered Roller Bearings

Bearings of this type use conical rollers guided by a back-face rib on the cone. These bearings are capable of taking high radial loads and also axial loads in one direction. In the HR series, the rollers are increased in both size and number giving it an even higher load capacity.

They are generally mounted in pairs in a manner similar to single-row angular contact ball bearings. In this case, the proper internal clearance can be obtained by adjusting the axial distance between the cones or cups of the two opposed bearings. Since they are separable, the cone assemblies and cups can be mounted independently.

Depending upon the contact angle, tapered roller bearings are divided into three types called the normal angle, medium angle, and steep angle. Double-row and four-row tapered roller bearings are also available. Pressed steel cages are generally used.

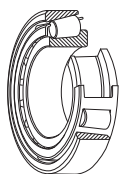

Spherical Roller Bearings

These bearings have barrel-shaped rollers between the inner ring, which has two raceways, and the outer ring which has one spherical raceway. Since the center of curvature of the outer ring raceway surface coincides with the bearing axis, they are self-aligning in a manner similar to that of self-aligning ball bearings. Therefore, if there is deflection of the shaft or housing or misalignment of their axes, it is automatically corrected so excessive force is not applied to the bearings.

Spherical roller bearings can take, not only heavy radial loads, but also some axial loads in either direction. They have excellent radial load-carrying capacity and are suitable for use where there are heavy or impact loads.

Some bearings have tapered bores and may be mounted directly on tapered shafts or cylindrical shafts using adapters or withdrawal sleeves.

Pressed steel and machined brass cages are used.

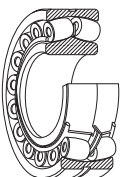

Single-Direction Thrust Ball Bearings



Single-direction thrust ball bearings are composed of washer-like bearing rings with raceway grooves. The ring attached to the shaft is called the shaft washer (or inner ring) while that attached to the housing is called the housing washer (or outer ring).

Double-Direction Thrust Ball Bearings

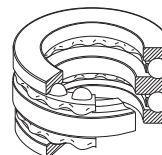

In double-direction thrust ball bearings, there are three rings with the middle one (center ring) being fixed to the shaft.

There are also thrust ball bearings with an aligning seat washer beneath the housing washer in order to compensate for shaft misalignment or mounting error.

Pressed steel cages are usually used in the smaller bearings and machined cages in the larger ones.

Spherical Thrust Roller Bearings



These bearings have a spherical raceway in the housing washer and barrel-shaped rollers obliquely arranged around it. Since the raceway in the housing washer is spherical, these bearings are self-aligning. They have a very high axial load capacity and are capable of taking moderate radial loads when an axial load is applied.

Pressed steel cages or machined brass cages are usually used.

Table 1. 1 Types and Characteristics

Features		Deep Groove Ball Bearings	Magneto Bearings	Angular Contact Ball Bearings	Double-Row Angular Contact Ball Bearings	Duplex Angular Contact Ball Bearings	Four-Point Contact Ball Bearings	Self-Aligning Ball Bearings	Cylindrical Roller Bearings	Double-Row Cylindrical Roller Bearings	Cylindrical Roller Bearings with Single Rib
Load Capacity	Radial Loads										
	Axial Loads										
	Combined Loads										
High Speeds											
High Accuracy											
Low Noise and Torque											
Rigidity											
Angular Misalignment											
Self-Aligning Capability											
Ring Separability											
Fixed-End Bearing											
Free-End Bearing											
Tapered Bore in Inner Ring											
Remarks			Two bearings are usually mounted in opposition.	Contact angles of 15°, 30°, 36° and 40°. Two bearings are usually mounted in opposition. Clearance adjustment is necessary.		Combination of DF and DT pairs is possible, but use on free-end is not possible.	Contact angle of 35°		Including N type	Including NNU type	Including NF type
Page No.		B5 B31	B5 B28	B47	B47 B70	B47	B47 B72	B77	B85	B85 B110	B85

Excellent
 Good
 Fair
 Poor
 Impossible
 One direction only
 Two directions

☆ Applicable
 ★ Applicable, but it is necessary to allow shaft contraction/elongation at fitting surfaces of bearings.

of Rolling Bearings

Cylindrical Roller Bearings with Thrust Collars	Needle Roller Bearings	Tapered Roller Bearings	Double- and Multiple-Row Tapered Roller Bearings	Spherical Roller Bearings	Thrust Ball Bearings	Thrust Ball Bearings with Aligning Seat	Double-Direction Angular Contact Thrust Ball Bearings	Thrust Cylindrical Roller Bearings	Thrust Tapered Roller Bearings	Thrust Spherical Roller Bearings	Page No.
											—
											—
											—
											—
											A18 A37
											A19 A58 A81
											A19
											A19 A96
											A18 Blue pages of each brg. type
											A18
											A19 A20
											A20 -A21
											A20 -A27
											A80 A118 A122
Including NUP type			Two bearings are usually mounted in opposition. Clearance adjustment is necessary.								
				KH, KV types are also available but use on free-end is impossible.							
								Including needle roller thrust bearings			
										To be used with oil lubrication	
B85	—	B115	B115 B176 B299	B183	B207	B207	B235	B207 B224	—	B207 B228	

2. BEARING SELECTION PROCEDURE

The number of applications for rolling bearings is almost countless and the operating conditions and environments also vary greatly. In addition, the diversity of operating conditions and bearing requirements continue to grow with the rapid advancement of technology. Therefore, it is necessary to study bearings carefully from many angles to select the best one from the thousands of types and sizes available. Usually, a bearing type is provisionally chosen considering the operating conditions, mounting arrangement, ease of mounting in the machine, allowable space, cost, availability, and other factors.

Then the size of the bearing is chosen to satisfy the desired life requirement. When doing this, in addition to fatigue life, it is necessary to consider grease life, noise and vibration, wear, and other factors. There is no fixed procedure for selecting bearings. It is good to investigate experience with similar applications and studies relevant to any special requirements for your specific application. When selecting bearings for new machines, unusual operating conditions, or harsh environments, please consult with NSK. The following diagram (Fig.2.1) shows an example of the bearing selection procedure.

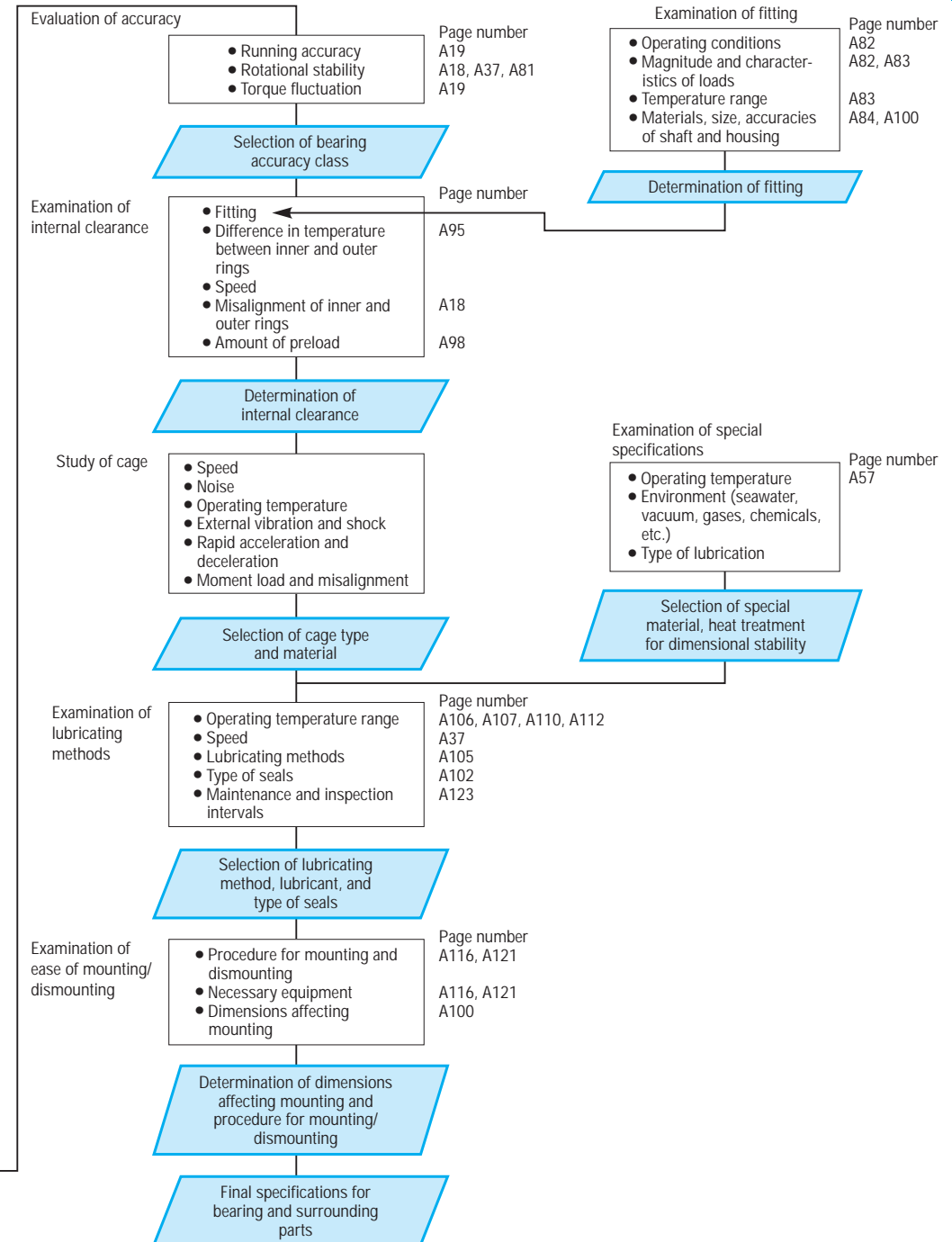
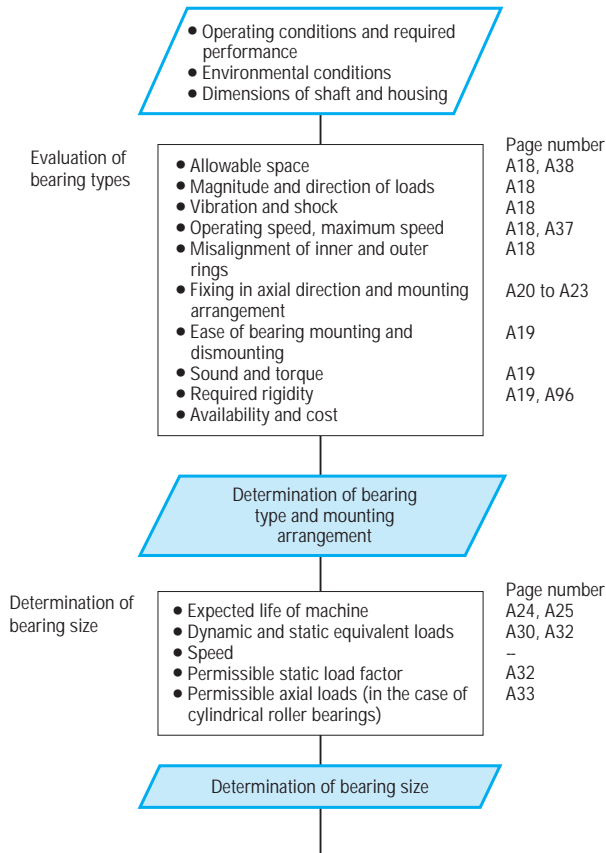

Fig. 2.1 Flow Chart for Selection of Rolling Bearings

4. SELECTION OF BEARING ARRANGEMENT

In general, shafts are supported by only two bearings. When considering the bearing mounting arrangement, the following items must be investigated:

- (1) Expansion and contraction of the shaft caused by temperature variations.
- (2) Ease of bearing mounting and dismounting.
- (3) Misalignment of the inner and outer rings caused by deflection of the shaft or mounting error.
- (4) Rigidity of the entire system including bearings and preloading method.
- (5) Capability to sustain the loads at their proper positions and to transmit them.

4.1 Fixed-End and Free-End Bearings

Among the bearings on a shaft, only one can be a "fixed-end" bearing that is used to fix the shaft axially. For this fixed-end bearing, a type which can carry both radial and axial loads must be selected. Bearings other than the fixed-end one must be "free-end" bearings that carry only radial loads to relieve the shaft's thermal elongation and contraction.

If measures to relieve a shaft's thermal elongation and contraction are insufficient, abnormal axial loads are applied to the bearings, which can cause premature failure.

For free-end bearings, cylindrical roller bearings or needle roller bearings with separable inner and outer rings that are free to move axially (NU, N types, etc.) are recommended. When these types are used, mounting and dismounting are also easier.

When non-separable types are used as free-end bearings, usually the fit between the outer ring and housing is loose to allow axial movement of the running shaft together with the bearing. Sometimes, such elongation is relieved by a loose fitting between the inner ring and shaft.

When the distance between the bearings is short and the influence of the shaft elongation and contraction is negligible, two opposed angular contact ball bearings or tapered roller bearings are used. The axial clearance (possible axial movement) after the mounting is adjusted using nuts or shims.

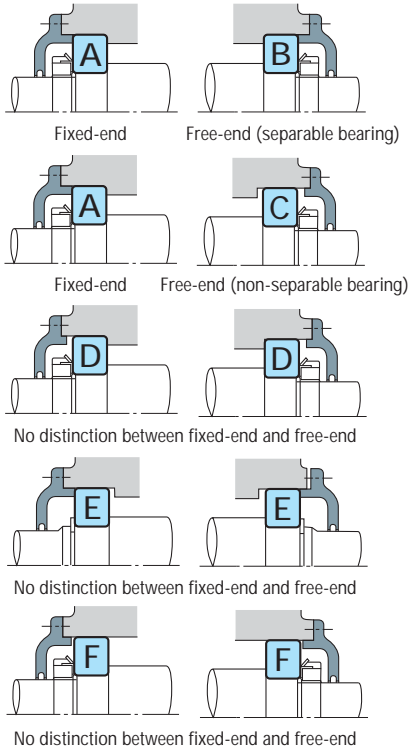

- BEARING A**
 - Deep Groove Ball Bearing
 - Matched Angular Contact Ball Bearing
 - Double-Row Angular Contact Ball Bearing
 - Self-Aligning Ball Bearing
 - Cylindrical Roller Bearing with Ribs (NH, NUP types)
 - Double-Row Tapered Roller Bearing
 - Spherical Roller Bearing
- BEARING B**
 - Cylindrical Roller Bearing (NU, N types)
 - Needle Roller Bearing (NA type, etc.)
- BEARING C(1)**
 - Deep Groove Ball Bearing
 - Matched Angular Contact Ball Bearing (back-to-back)
 - Double-Row Angular Contact Ball Bearing
 - Self-Aligning Ball Bearing
 - Double-Row Tapered Roller Bearing (KBE type)
 - Spherical Roller Bearing
- BEARING D,E(2)**
 - Angular Contact Ball Bearing
 - Tapered Roller Bearing
 - Magneto Bearing
 - Cylindrical Roller Bearing (NJ, NF types)
- BEARING F**
 - Deep Groove Ball Bearing
 - Self-Aligning Ball Bearing
 - Spherical Roller Bearing

Notes: (1) In the figure, shaft elongation and contraction are relieved at the outside surface of the outer ring, but sometimes it is done at the bore.
 (2) For each type, two bearings are used in opposition.

The distinction between free-end and fixed-end bearings and some possible bearing mounting arrangements for various bearing types are shown in Fig. 4.1.

4.2 Example of Bearing Arrangements

Some representative bearing mounting arrangements considering preload and rigidity of the entire assembly, shaft elongation and contraction, mounting error, etc. are shown in Table 4.1.

Table 4.1 Representative Bearing Mounting Arrangements and Application Examples

Bearing Arrangements		Remarks	Application Examples
Fixed-end	Free-end		
		<ul style="list-style-type: none"> ○ This is a common arrangement in which abnormal loads are not applied to bearings even if the shaft expands or contracts. ○ If the mounting error is small, this is suitable for high speeds. 	Medium size electric motors, blowers
		<ul style="list-style-type: none"> ○ This can withstand heavy loads and shock loads and can take some axial load. ○ Every type of cylindrical roller bearing is separable. This is helpful when interference is necessary for both the inner and outer rings. 	Traction motors for rolling stock
		<ul style="list-style-type: none"> ○ This is used when loads are relatively heavy. ○ For maximum rigidity of the fixed-end bearing, it is a back-to-back type. ○ Both the shaft and housing must have high accuracy and the mounting error must be small. 	Table rollers for steel mills, main spindles of lathes
		<ul style="list-style-type: none"> ○ This is also suitable when interference is necessary for both the inner and outer rings. Heavy axial loads cannot be applied. 	Calender rolls of paper making machines, axles of diesel locomotives
		<ul style="list-style-type: none"> ○ This is suitable for high speeds and heavy radial loads. Moderate axial loads can also be applied. ○ It is necessary to provide some clearance between the outer ring of the deep groove ball bearing and the housing bore in order to avoid subjecting it to radial loads. 	Reduction gears in diesel locomotives

Fig. 4.1 Bearing Mounting Arrangements and Bearing Types

Continued on next page

Table 4. 1 Representative Bearing Mounting Arrangements and Application Examples (cont'd)

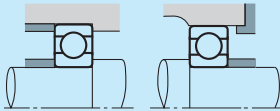
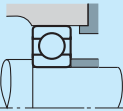
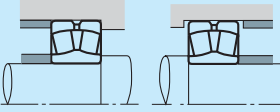
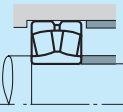
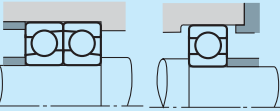
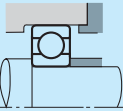
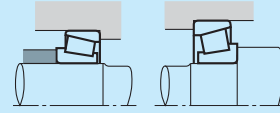
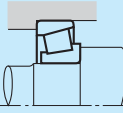
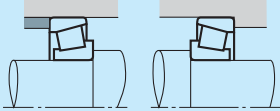
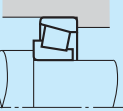
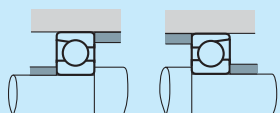
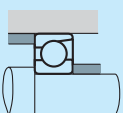
Bearing Arrangements		Remarks	Application Examples
Fixed-end	Free-end		
		<ul style="list-style-type: none"> This is the most common arrangement. It can sustain not only radial loads, but moderate axial loads also. 	Double suction volute pumps, automotive transmissions
		<ul style="list-style-type: none"> This is the most suitable arrangement when there is mounting error or shaft deflection. It is often used for general and industrial applications in which heavy loads are applied. 	Speed reducers, table rollers of steel mills, wheels for overhead travelling cranes
		<ul style="list-style-type: none"> This is suitable when there are rather heavy axial loads in both directions. Double row angular contact bearings may be used instead of an arrangement of two angular contact ball bearings. 	Worm gear reducers
When there is no distinction between fixed-end and free-end		Remarks	Application Examples
		<ul style="list-style-type: none"> This arrangement is widely used since it can withstand heavy loads and shock loads. The back-to-back arrangement is especially good when the distance between bearings is short and moment loads are applied. Face-to-face mounting makes mounting easier when interference is necessary for the inner ring. In general, this arrangement is good when there is mounting error. To use this arrangement with a preload, attention must be paid to the amount of preload and clearance adjustment. 	Pinion shafts of automotive differential gears, automotive front and rear axles, worm gear reducers
			
		<ul style="list-style-type: none"> This is used at high speeds when radial loads are not so heavy and axial loads are relatively heavy. It provides good rigidity of the shaft by preloading. For moment loads, back-to-back mounting is better than face-to-face mounting. 	Grinding wheel shafts

Continued on next page

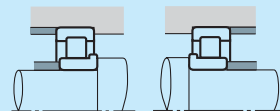
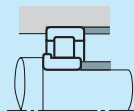
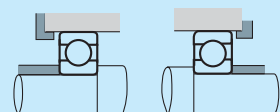
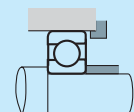
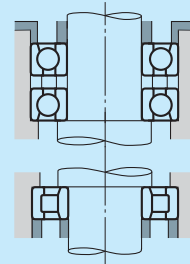
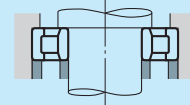
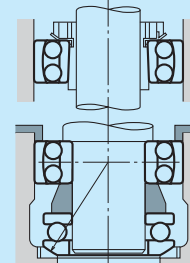
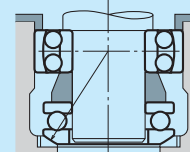
When there is no distinction between fixed-end and free-end		Remarks	Application Examples
			
		<ul style="list-style-type: none"> Sometimes a spring is used at the side of the outer ring of one bearing. 	Small electric motors, small speed reducers, small pumps
Vertical arrangements		Remarks	Application Examples
		<ul style="list-style-type: none"> Matched angular contact ball bearings are on the fixed end. Cylindrical roller bearing is on the free end. 	Vertical electric motors
		<ul style="list-style-type: none"> The spherical center of the self-aligning seat must coincide with that of the self-aligning ball bearing. The upper bearing is on the free end. 	Vertical openers (spinning and weaving machines)

5. SELECTION OF BEARING SIZE

5.1 Bearing Life

The various functions required of rolling bearings vary according to the bearing application. These functions must be performed for a prolonged period. Even if bearings are properly mounted and correctly operated, they will eventually fail to perform satisfactorily due to an increase in noise and vibration, loss of running accuracy, deterioration of grease, or fatigue flaking of the rolling surfaces.

Bearing life, in the broad sense of the term, is the period during which bearings continue to operate and to satisfy their required functions. This bearing life may be defined as noise life, abrasion life, grease life, or rolling fatigue life, depending on which one causes loss of bearing service.

Aside from the failure of bearings to function due to natural deterioration, bearings may fail when conditions such as heat-seizure, fracture, scoring of the rings, damage of the seals or the cage, or other damage occurs.

Conditions such as these should not be interpreted as normal bearing failure since they often occur as a result of errors in bearing selection, improper design or manufacture of the bearing surroundings, incorrect mounting, or insufficient maintenance.

5.1.1 Rolling Fatigue Life and Basic Rating Life

When rolling bearings are operated under load, the raceways of their inner and outer rings and rolling elements are subjected to repeated cyclic stress. Because of metal fatigue of the rolling contact surfaces of the raceways and rolling elements, scaly particles may separate from the bearing material (Fig. 5.1). This phenomenon is called "flaking". Rolling fatigue life is represented by the total number of revolutions at which time the bearing surface will start flaking due to stress. This is called fatigue life. As shown in Fig. 5.2, even for seemingly identical bearings, which are of the same type, size, and material and receive the same heat treatment and other processing, the rolling fatigue life varies greatly even under identical operating conditions. This is because the flaking of materials due to fatigue is subject to many other variables. Consequently, "basic rating life", in which rolling fatigue life is treated as a statistical phenomenon, is used in preference to actual rolling fatigue life.

Suppose a number of bearings of the same type are operated individually under the same conditions. After a certain period of time, 10 % of them fail as a result of flaking caused by rolling fatigue. The total number of revolutions at this point is defined as the basic rating life or, if the speed is constant, the basic rating life is often expressed by the total number of operating hours completed when 10 % of the bearings become inoperable due to flaking.

In determining bearing life, basic rating life is often the only factor considered. However, other factors must also be taken into account. For example, the grease life

of grease-prelubricated bearings (refer to Section 12, Lubrication, Page A107) can be estimated. Since noise life and abrasion life are judged according to individual standards for different applications, specific values for noise or abrasion life must be determined empirically.

5.2 Basic Load Rating and Fatigue Life

5.2.1 Basic Load Rating

The basic load rating is defined as the constant load applied on bearings with stationary outer rings that the inner rings can endure for a rating life of one million revolutions (10^6 rev). The basic load rating of radial bearings is defined as a central radial load of constant direction and magnitude, while the basic load rating of thrust bearings is defined as an axial load of constant magnitude in the same direction as the central axis. The load ratings are listed under C_r for radial bearings and C_a for thrust bearings in the dimension tables.

5.2.2 Machinery in which Bearings are Used and Projected Life

It is not advisable to select bearings with unnecessarily high load ratings, for such bearings may be too large and uneconomical. In addition, the bearing life alone should not be the deciding factor in the selection of bearings. The strength, rigidity, and design of the shaft



Fig. 5.1 Example of Flaking

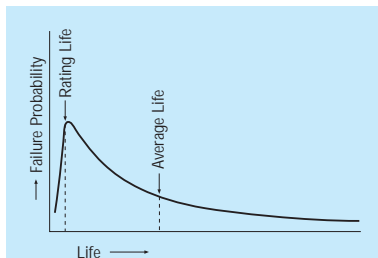

Fig. 5.2 Failure Probability and Bearing Life

Table 5. 1 Fatigue Life Factor f_h for Various Bearing Applications

Operating Periods	Fatigue Life Factor f_h				
	~3	2~4	3~5	4~7	6~
Infrequently used or only for short periods	· Small motors for home appliances like vacuum cleaners and washing machines · Hand power tools	· Agricultural equipment			
Used only occasionally but reliability is important		· Motors for home heaters and air conditioners · Construction equipment	· Conveyors · Elevator cable sheaves		
Used intermittently for relatively long periods	· Rolling mill roll necks	· Small motors · Deck cranes · General cargo cranes · Pinion stands · Passenger cars	· Factory motors · Machine tools · Transmissions · Vibrating screens · Crushers	· Crane sheaves · Compressors · Specialized transmissions	
Used intermittently for more than eight hours daily		· Escalators	· Centrifugal separators · Air conditioning equipment · Blowers · Woodworking machines · Large motors · Axle boxes on railway rolling stock	· Mine hoists · Press flywheels · Railway traction motors · Locomotive axle boxes	· Paper making machines
Used continuously and high reliability is important					· Waterworks pumps · Electric power stations · Mine draining pumps

on which the bearings are to be mounted should also be considered. Bearings are used in a wide range of applications and the design life varies with specific applications and operating conditions. Table 5.1 gives an empirical fatigue life factor derived from customary operating experience for various machines. Also refer to Table 5.2.

5.2.3 Selection of Bearing Size Based on Basic Load Rating

The following relation exists between bearing load and basic rating life:

$$\text{For ball bearings } L = \left(\frac{C}{P}\right)^3 \dots\dots\dots (5.1)$$

$$\text{For roller bearings } L = \left(\frac{C}{P}\right)^{10/3} \dots\dots\dots (5.2)$$

where L : Basic rating life (10^6 rev)
 P : Bearing load (equivalent load) (N), {kgf}
(Refer to Page A30)
 C : Basic load rating (N), {kgf}
 For radial bearings, C is written C_r
 For thrust bearings, C is written C_a

In the case of bearings that run at a constant speed, it is convenient to express the fatigue life in terms of hours. In general, the fatigue life of bearings used in automobiles and other vehicles is given in terms of mileage.

By designating the basic rating life as L_h (h), bearing speed as n (min^{-1}), fatigue life factor as f_h , and speed factor as f_n , the relations shown in Table 5.2 are obtained:

Table 5. 2 Basic Rating Life, Fatigue Life Factor and Speed Factor

Life Parameters	Ball Bearings	Roller Bearings
Basic Rating Life	$L_h = \frac{10^6}{60n} \left(\frac{C}{P}\right)^3 = 500 f_h^3$	$L_h = \frac{10^6}{60n} \left(\frac{C}{P}\right)^{10/3} = 500 f_h^{10/3}$
Fatigue Life Factor	$f_h = f_n \frac{C}{P}$	$f_h = f_n \frac{C}{P}$
Speed Factor	$f_n = \left(\frac{10^6}{500 \times 60 n}\right)^{1/3} = (0.03n)^{-1/3}$	$f_n = \left(\frac{10^6}{500 \times 60 n}\right)^{3/10} = (0.03n)^{-3/10}$

n, f_nFig. 5.3 (See Page A26), Appendix Table 12 (See Page C24)
 L_h, f_hFig. 5.4 (See Page A26), Appendix Table 13 (See Page C25)

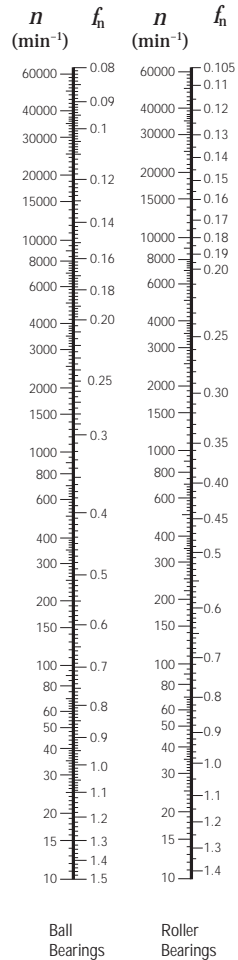

Fig. 5.3 Bearing Speed and Speed Factor

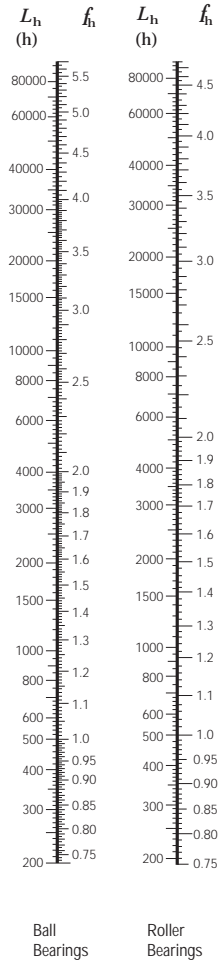

Fig. 5.4 Fatigue Life Factor and Fatigue Life

If the bearing load P and speed n are known, determine a fatigue life factor f_h appropriate for the projected life of the machine and then calculate the basic load rating C by means of the following equation.

$$C = \frac{f_h \cdot P}{f_n} \dots\dots\dots (5.3)$$

A bearing which satisfies this value of C should then be selected from the bearing tables.

5.2.4 Temperature Adjustment for Basic Load Rating

If rolling bearings are used at high temperature, the hardness of the bearing steel decreases. Consequently, the basic load rating, which depends on the physical properties of the material, also decreases. Therefore, the basic load rating should be adjusted for the higher temperature using the following equation:

$$C_t = f_t \cdot C \dots\dots\dots (5.4)$$

where C_t : Basic load rating after temperature correction (N), {kgf}

f_t : Temperature factor (See Table 5.3.)

C : Basic load rating before temperature adjustment (N), {kgf}

If large bearings are used at higher than 120°C, they must be given special dimensional stability heat treatment to prevent excessive dimensional changes. The basic load rating of bearings given such special dimensional stability heat treatment may become lower than the basic load rating listed in the bearing tables.

Table 5.3 Temperature Factor f_t

Bearing Temperature °C	125	150	175	200	250
Temperature Factor f_t	1.00	1.00	0.95	0.90	0.75

5.2.5 Correction of Basic Rating Life

As described previously, the basic equations for calculating the basic rating life are as follows:

For ball bearings $L_{10} = \left(\frac{C}{P}\right)^3 \dots\dots\dots (5.5)$

For roller bearings $L_{10} = \left(\frac{C}{P}\right)^{\frac{10}{3}} \dots\dots\dots (5.6)$

The L_{10} life is defined as the basic rating life with a statistical reliability of 90%. Depending on the machines in which the bearings are used, sometimes a reliability higher than 90% may be required. However, recent improvements in bearing material have greatly extended the fatigue life. In addition, the development of the Elasto-Hydrodynamic Theory of Lubrication proves that the thickness of the lubricating film in the contact zone between rings and rolling elements greatly influences bearing life. To reflect such improvements in the calculation of fatigue life, the basic rating life is adjusted using the following adjustment factors:

$$L_{na} = a_1 a_2 a_3 L_{10} \dots\dots\dots (5.7)$$

where L_{na} : Adjusted rating life in which reliability, material improvements, lubricating conditions, etc. are considered

L_{10} : Basic rating life with a reliability of 90%

a_1 : Life adjustment factor for reliability

a_2 : Life adjustment factor for special bearing properties

a_3 : Life adjustment factor for operating conditions

The life adjustment factor for reliability, a_1 , is listed in Table 5.4 for reliabilities higher than 90%.

The life adjustment factor for special bearing properties, a_2 , is used to reflect improvements in bearing steel.

NSK now uses vacuum degassed bearing steel, and the results of tests by NSK show that life is greatly improved when compared with earlier materials. The basic load ratings C_r and C_a listed in the bearing tables were calculated considering the extended life achieved by improvements in materials and manufacturing techniques. Consequently, when estimating life using Equation (5.7), it is sufficient to assume that is greater than one.

Table 5.4 Reliability Factor a_1

Reliability (%)	90	95	96	97	98	99
a_1	1.00	0.62	0.53	0.44	0.33	0.21

The life adjustment factor for operating conditions a_3 is used to adjust for various factors, particularly lubrication. If there is no misalignment between the inner and outer rings and the thickness of the lubricating film in the contact zones of the bearing is sufficient, it is possible for a_3 to be greater than one; however, a_3 is less than one in the following cases:

- When the viscosity of the lubricant in the contact zones between the raceways and rolling elements is low.
- When the circumferential speed of the rolling elements is very slow.
- When the bearing temperature is high.
- When the lubricant is contaminated by water or foreign matter.
- When misalignment of the inner and outer rings is excessive.

It is difficult to determine the proper value for a_3 for specific operating conditions because there are still many unknowns. Since the special bearing property factor a_2 is also influenced by the operating conditions, there is a proposal to combine a_2 and a_3 into one quantity ($a_2 \times a_3$), and not consider them independently. In this case, under normal lubricating and operating conditions, the product ($a_2 \times a_3$) should be assumed equal to one. However, if the viscosity of the lubricant is too low, the value drops to as low as 0.2.

If there is no misalignment and a lubricant with high viscosity is used so sufficient fluid-film thickness is secured, the product of ($a_2 \times a_3$) may be about two.

When selecting a bearing based on the basic load rating, it is best to choose an a_1 reliability factor appropriate for the projected use and an empirically determined C/P or f_h value derived from past results for lubrication, temperature, mounting conditions, etc. in similar machines.

The basic rating life equations (5.1), (5.2), (5.5), and (5.6) give satisfactory results for a broad range of bearing loads. However, extra heavy loads may cause detrimental plastic deformation at ball/raceway contact points. When P_r exceeds C_{0r} (Basic static load rating) or $0.5 C_r$, whichever is smaller, for radial bearings or P_a exceeds $0.5 C_a$ for thrust bearings, please consult NSK to establish the applicability of the rating fatigue life equations.

5.3 Calculation of Bearing Loads

The loads applied on bearings generally include the weight of the body to be supported by the bearings, the weight of the revolving elements themselves, the transmission power of gears and belting, the load produced by the operation of the machine in which the bearings are used, etc. These loads can be theoretically calculated, but some of them are difficult to estimate. Therefore, it becomes necessary to correct the estimated using empirically derived data.

5.3.1 Load Factor

When a radial or axial load has been mathematically calculated, the actual load on the bearing may be greater than the calculated load because of vibration and shock present during operation of the machine. The actual load may be calculated using the following equation:

$$\left. \begin{aligned} F_r &= f_w \cdot F_{rc} \\ F_a &= f_w \cdot F_{ac} \end{aligned} \right\} \dots\dots\dots (5.8)$$

where F_r, F_a : Loads applied on bearing (N), {kgf}

F_{rc}, F_{ac} : Theoretically calculated load (N), {kgf}

f_w : Load factor

The values given in Table 5.5 are usually used for the load factor f_w .

5.3.2 Bearing Loads in Belt or Chain Transmission Applications

The force acting on the pulley or sprocket wheel when power is transmitted by a belt or chain is calculated using the following equations.

$$\left. \begin{aligned} M &= 9\,550\,000H / n \dots (N \cdot mm) \\ &= 974\,000H / n \dots (kgf \cdot mm) \end{aligned} \right\} \dots\dots\dots (5.9)$$

$$P_k = M / r \dots\dots\dots (5.10)$$

where M : Torque acting on pulley or sprocket wheel (N·mm), {kgf·mm}

P_k : Effective force transmitted by belt or chain (N), {kgf}

H : Power transmitted (kW)

n : Speed (min⁻¹)

r : Effective radius of pulley or sprocket wheel (mm)

When calculating the load on a pulley shaft, the belt tension must be included. Thus, to calculate the actual load K_b in the case of a belt transmission, the effective transmitting power is multiplied by the belt factor f_b , which represents the belt tension. The values of the belt factor f_b for different types of belts are shown in Table 5.6.

$$K_b = f_b \cdot P_k \dots\dots\dots (5.11)$$

In the case of a chain transmission, the values corresponding to f_b should be 1.25 to 1.5.

5.3.3 Bearing Loads in Gear Transmission Applications

The loads imposed on gears in gear transmissions vary according to the type of gears used. In the simplest case of spur gears, the load is calculated as follows:

$$\left. \begin{aligned} M &= 9\,550\,000H / n \dots (N \cdot mm) \\ &= 974\,000H / n \dots (kgf \cdot mm) \end{aligned} \right\} \dots\dots\dots (5.12)$$

$$P_k = M / r \dots\dots\dots (5.13)$$

$$S_k = P_k \tan \theta \dots\dots\dots (5.14)$$

$$K_c = \sqrt{P_k^2 + S_k^2} = P_k \sec \theta \dots\dots\dots (5.15)$$

where M : Torque applied to gear (N·mm), {kgf·mm}

P_k : Tangential force on gear (N), {kgf}

S_k : Radial force on gear (N), {kgf}

K_c : Combined force imposed on gear (N), {kgf}

H : Power transmitted (kW)

n : Speed (min⁻¹)

r : Pitch circle radius of drive gear (mm)

θ : Pressure angle

In addition to the theoretical load calculated above, vibration and shock (which depend on how accurately the gear is finished) should be included using the gear factor f_g by multiplying the theoretically calculated load by this factor.

The values of f_g should generally be those in Table 5.7. When vibration from other sources accompanies gear operation, the actual load is obtained by multiplying the load factor by this gear factor.

5.3.4 Load Distribution on Bearings

In the simple examples shown in Figs. 5.5 and 5.6. The radial loads on bearings I and II can be calculated using the following equations:

$$F_{CI} = \frac{b}{c} K \dots\dots\dots (5.16)$$

$$F_{CII} = \frac{a}{c} K \dots\dots\dots (5.17)$$

where F_{CI} : Radial load applied on bearing I (N), {kgf}

F_{CII} : Radial load applied on bearing II (N), {kgf}

K : Shaft load (N), {kgf}

When these loads are applied simultaneously, first the radial load for each should be obtained, and then, the sum of the vectors may be calculated according to the load direction.

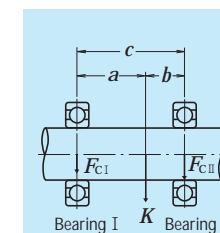

Fig. 5.5 Radial Load Distribution (1)

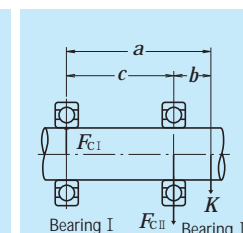

Fig. 5.6 Radial Load Distribution (2)

Table 5.5 Values of Load Factor f_w

Operating Conditions	Typical Applications	f_w
Smooth operation free from shocks	Electric motors, Machine tools, Air conditioners	1 to 1.2
Normal operation	Air blowers, Compressors, Elevators, Cranes, Paper making machines	1.2 to 1.5
Operation accompanied by shock and vibration	Construction equipment, Crushers, Vibrating screens, Rolling mills	1.5 to 3

Table 5.6 Belt Factor f_b

Type of Belt	f_b
Toothed belts	1.3 to 2
V belts	2 to 2.5
Flat belts with tension pulley	2.5 to 3
Flat belts	4 to 5

Table 5.7 Values of Gear Factor f_g

Gear Finish Accuracy	f_g
Precision ground gears	1 ~ 1.1
Ordinary machined gears	1.1 ~ 1.3

5.3.5 Average of Fluctuating Load

When the load applied on bearings fluctuates, an average load which will yield the same bearing life as the fluctuating load should be calculated.

(1) When the relation between load and rotating speed is divided into the following steps (Fig. 5.7)

- Load F_1 : Speed n_1 ; Operating time t_1
- Load F_2 : Speed n_2 ; Operating time t_2
- ⋮
- Load F_n : Speed n_n ; Operating time t_n

Then, the average load F_m may be calculated using the following equation:

$$F_m = \sqrt[p]{\frac{F_1^p n_1 t_1 + F_2^p n_2 t_2 + \dots + F_n^p n_n t_n}{n_1 t_1 + n_2 t_2 + \dots + n_n t_n}} \dots\dots\dots (5.18)$$

where F_m : Average fluctuating load (N), {kgf}

$p = 3$ for ball bearings

$p = 10/3$ for roller bearings

The average speed n_m may be calculated as follows:

$$n_m = \frac{n_1 t_1 + n_2 t_2 + \dots + n_n t_n}{t_1 + t_2 + \dots + t_n} \dots\dots\dots(5.19)$$

(2) When the load fluctuates almost linearly (Fig. 5.8), the average load may be calculated as follows:

$$F_m \doteq \frac{1}{3} (F_{min} + 2F_{max}) \dots\dots\dots(5.20)$$

where F_{min} : Minimum value of fluctuating load (N), {kgf}

F_{max} : Maximum value of fluctuating load (N), {kgf}

(3) When the load fluctuation is similar to a sine wave (Fig. 5.9), an approximate value for the average load F_m may be calculated from the following equation:

In the case of Fig. 5.9 (a)

$$F_m \doteq 0.65 F_{max} \dots\dots\dots(5.21)$$

In the case of Fig. 5.9 (b)

$$F_m \doteq 0.75 F_{max} \dots\dots\dots(5.22)$$

(4) When both a rotating load and a stationary load are applied (Fig. 5.10).

F_R : Rotating load (N), {kgf}

F_S : Stationary load (N), {kgf}

An approximate value for the average load F_m may be calculated as follows:

a) Where $F_R \geq F_S$

$$F_m \doteq F_R + 0.3F_S + 0.2 \frac{F_S^2}{F_R} \dots\dots\dots(5.23)$$

b) Where $F_R < F_S$

$$F_m \doteq F_S + 0.3F_R + 0.2 \frac{F_R^2}{F_S} \dots\dots\dots(5.24)$$

5.4 Equivalent Load

In some cases, the loads applied on bearings are purely radial or axial loads; however, in most cases, the loads are a combination of both. In addition, such loads usually fluctuate in both magnitude and direction. In such cases, the loads actually applied on bearings cannot be used for bearing life calculations; therefore, a hypothetical load that has a constant magnitude and passes through the center of the bearing, and will give the same bearing life that the bearing would attain under actual conditions of load and rotation should be estimated. Such a hypothetical load is called the equivalent load.

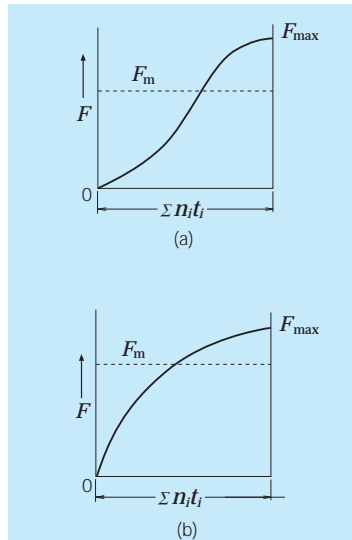

Fig. 5.9 Sinusoidal Load Variation

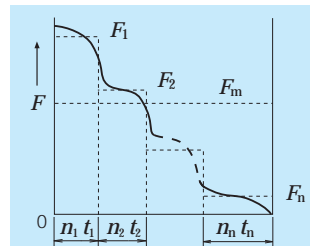

Fig. 5.7 Incremental Load Variation

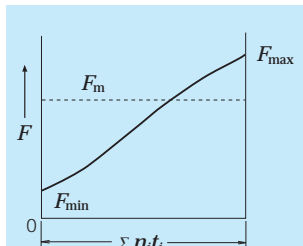

Fig. 5.8 Simple Load Fluctuation

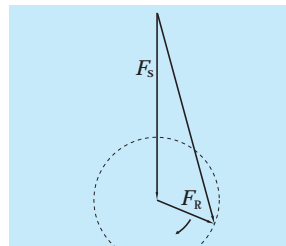

Fig. 5.10 Rotating Load and Stationary Load

5.4.1 Calculation of Equivalent Loads

The equivalent load on radial bearings may be calculated using the following equation:

$$P = XF_r + YF_a \dots\dots\dots(5.25)$$

where P : Equivalent Load (N), {kgf}

F_r : Radial load (N), {kgf}

F_a : Axial load (N), {kgf}

X : Radial load factor

Y : Axial load factor

The values of X and Y are listed in the bearing tables. The equivalent radial load for radial roller bearings with $\alpha = 0^\circ$ is

$$P = F_r$$

In general, thrust ball bearings cannot take radial loads, but spherical thrust roller bearings can take some radial loads. In this case, the equivalent load may be calculated using the following equation:

$$P = F_a + 1.2F_r \dots\dots\dots(5.26)$$

where $\frac{F_r}{F_a} \leq 0.55$

5.4.2 Axial Load Components in Angular Contact Ball Bearings and Tapered Roller Bearings

The effective load center of both angular contact ball bearings and tapered roller bearings is at the point of intersection of the shaft center line and a line representing the load applied on the rolling element by the outer ring as shown in Fig. 5.11. This effective load

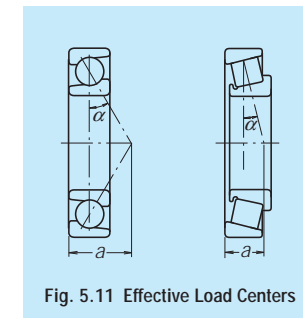

Fig. 5.11 Effective Load Centers

center for each bearing is listed in the bearing tables. When radial loads are applied to these types of bearings, a component of load is produced in the axial direction. In order to balance this component load, bearings of the same type are used in pairs, placed face to face or back to back. These axial loads can be calculated using the following equation:

$$F_{ai} = \frac{0.6}{Y} F_r \dots\dots\dots(5.27)$$

where F_{ai} : Component load in the axial direction (N), {kgf}

F_r : Radial load (N), {kgf}

Y : Axial load factor

Assume that radial loads F_{rI} and F_{rII} are applied on bearings I and II (Fig. 5.12) respectively, and an external axial load F_{ae} is applied as shown. If the axial load factors are Y_I, Y_{II} and the radial load factor is X , then the equivalent loads P_I, P_{II} may be calculated as follows:

where $F_{ae} + \frac{0.6}{Y_{II}} F_{rII} \geq \frac{0.6}{Y_I} F_{rI}$

$$P_I = XF_{rI} + Y_I \left(F_{ae} + \frac{0.6}{Y_{II}} F_{rII} \right) \dots\dots\dots(5.28)$$

$$P_{II} = F_{rII}$$

where $F_{ae} + \frac{0.6}{Y_{II}} F_{rII} < \frac{0.6}{Y_I} F_{rI}$

$$P_I = F_{rI}$$

$$P_{II} = XF_{rII} + Y_{II} \left(\frac{0.6}{Y_I} F_{rI} - F_{ae} \right) \dots\dots\dots(5.29)$$

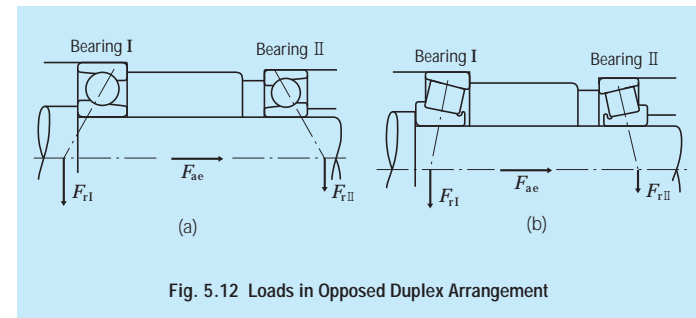

Fig. 5.12 Loads in Opposed Duplex Arrangement

5.5 Static Load Ratings and Static Equivalent Loads

5.5.1 Static Load Ratings

When subjected to an excessive load or a strong shock load, rolling bearings may incur a local permanent deformation of the rolling elements and permanent deformation of the rolling elements and raceway surface if the elastic limit is exceeded. The nonelastic deformation increases in area and depth as the load increases, and when the load exceeds a certain limit, the smooth running of the bearing is impeded.

The basic static load rating is defined as that static load which produces the following calculated contact stress at the center of the contact area between the rolling element subjected to the maximum stress and the raceway surface.

- For self-aligning ball bearings 4 600MPa (469kgf/mm²)
- For other ball bearings 4 200MPa (428kgf/mm²)
- For roller bearings 4 000MPa (408kgf/mm²)

In this most heavily stressed contact area, the sum of the permanent deformation of the rolling element and that of the raceway is nearly 0.0001 times the rolling element's diameter. The basic static load rating C_0 is written C_{0r} for radial bearings and C_{0a} for thrust bearings in the bearing tables.

In addition, following the modification of the criteria for basic static load rating by ISO, the new C_0 values for NSK's ball bearings became about 0.8 to 1.3 times the past values and those for roller bearings about 1.5 to 1.9 times. Consequently, the values of permissible static load factor f_s have also changed, so please pay attention to this.

5.5.2 Static Equivalent Loads

The static equivalent load is a hypothetical load that produces a contact stress equal to the above maximum stress under actual conditions, while the bearing is stationary (including very slow rotation or oscillation), in the area of contact between the most heavily stressed rolling element and bearing raceway. The static radial load passing through the bearing center is taken as the static equivalent load for radial bearings, while the static axial load in the direction coinciding with the central axis is taken as the static equivalent load for thrust bearings.

(a) Static equivalent load on radial bearings

The greater of the two values calculated from the following equations should be adopted as the static equivalent load on radial bearings.

$$P_o = X_o F_r + Y_o F_a \dots\dots\dots(5.30)$$

$$P_o = F_r \dots\dots\dots(5.31)$$

where P_o : Static equivalent load (N), {kgf}
 F_r : Radial load (N), {kgf}
 F_a : Axial load (N), {kgf}
 X_o : Static radial load factor
 Y_o : Static axial load factor

(b) Static equivalent load on thrust bearings

$$P_o = X_o F_r + F_a \quad \alpha \neq 90^\circ \dots\dots\dots(5.32)$$

where P_o : Static equivalent load (N), {kgf}
 α : Contact angle

When $F_a < X_o F_r$, this equation becomes less accurate. The values of X_o and Y_o for Equations (5.30) and (5.32) are listed in the bearing tables.

The static equivalent load for thrust roller bearings with

$$\alpha = 90^\circ \text{ is } P_o = F_a$$

5.5.3 Permissible Static Load Factor

The permissible static equivalent load on bearings varies depending on the basic static load rating and also their application and operating conditions.

The permissible static load factor f_s is a safety factor that is applied to the basic static load rating, and it is defined by the ratio in Equation (5.33). The generally recommended values of f_s are listed in Table 5.8. Conforming to the modification of the static load rating, the values of f_s were revised, especially for bearings for which the values of C_0 were increased, please keep this in mind when selecting bearings.

$$f_s = \frac{C_o}{P_o} \dots\dots\dots(5.33)$$

where C_o : Basic static load rating (N), {kgf}
 P_o : Static equivalent load (N), {kgf}

For spherical thrust roller bearings, the values of f_s should be greater than 4.

Table 5.8 Values of Permissible Static Load Factor f_s

Operating Conditions	Lower Limit of f_s	
	Ball Bearings	Roller Bearings
Low-noise applications	2	3
Bearings subjected to vibration and shock loads	1.5	2
Standard operating conditions	1	1.5

5.6 Maximum Permissible Axial Loads for Cylindrical Roller Bearings

Cylindrical roller bearings having inner and outer rings with ribs, loose ribs or thrust collars are capable of sustaining radial loads and limited axial loads simultaneously. The maximum permissible axial load is limited by an abnormal temperature rise or heat seizure due to sliding friction between the end faces of rollers and the rib face, or the rib strength.

The maximum permissible axial load (the load considered the heat generation between the end face of rollers and the rib face) for bearings of diameter series 3 that are continuously loaded and lubricated with grease or oil is shown in Fig. 5.13.

Grease lubrication (Empirical equation)

$$C_A = 9.8f \left\{ \frac{900(kd)^2}{n+1500} - 0.023 \times (kd)^{2.5} \right\} \dots\dots(5.34)$$

$$= f \left\{ \frac{900(kd)^2}{n+1500} - 0.023 \times (kd)^{2.5} \right\} \dots\dots[\text{kgf}]$$

Oil lubrication (Empirical equation)

$$C_A = 9.8f \left\{ \frac{490(kd)^2}{n+1000} - 0.000135 \times (kd)^{3.4} \right\} \dots\dots(5.35)$$

$$= f \left\{ \frac{490(kd)^2}{n+1000} - 0.000135 \times (kd)^{3.4} \right\} \dots\dots[\text{kgf}]$$

where C_A : Permissible axial load (N), {kgf}
 d : Bearing bore diameter (mm)
 n : Speed (min⁻¹)

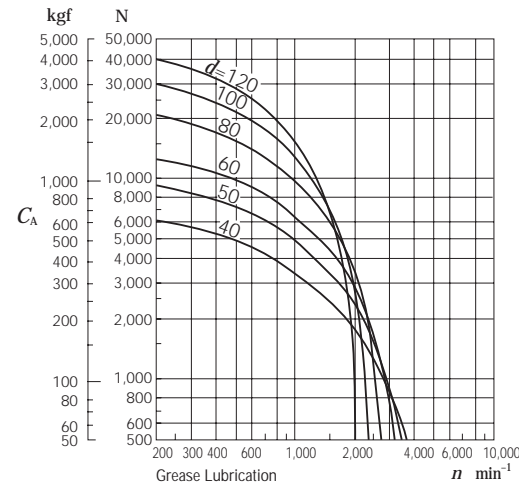

f : Load Factor		k : Size Factor	
Loading Interval	Value of f	Diameter series	Value of k
Continuous	1	2	0.75
Intermittent	2	3	1
Short time only	3	4	1.2

In the equations (5.34) and (5.35), the examination for the rib strength is excluded. Concerning the rib strength, please consult with NSK.

In addition, for cylindrical roller bearings to have a stable axial-load carrying capacity, the following precautions are required for the bearings and their surroundings:

- Radial load must be applied and the magnitude of radial load should be larger than that of axial load by 2.5 times or more.
- Sufficient lubricant must exist between the roller end faces and ribs.
- Superior extreme-pressure grease must be used.
- Sufficient running-in should be done.
- The mounting accuracy must be good.
- The radial clearance should not be more than necessary.

In cases where the bearing speed is extremely slow, the speed exceeds the limiting speed by more than 50%, or the bore diameter is more than 200mm, careful study is necessary for each case regarding lubrication, cooling, etc. In such a case, please consult with NSK.

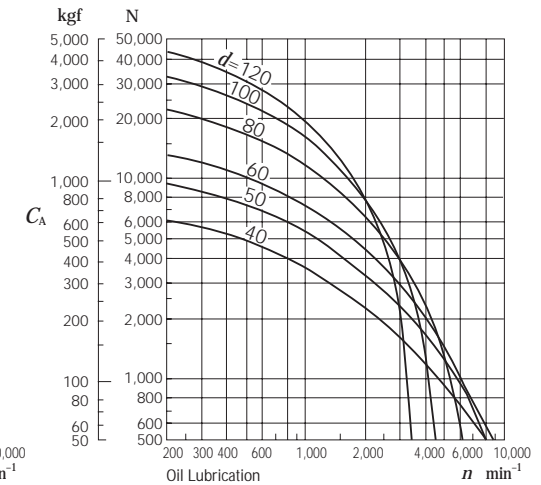

Fig. 5.13 Permissible Axial Load for Cylindrical Roller Bearings For Diameter Series 3 bearings ($k=1.0$) operating under a continuous load and lubricated with grease or oil.

5.7 Examples of Bearing Calculations

(Example 1)

Obtain the fatigue life factor f_h of single-row deep groove ball bearing **6208** when it is used under a radial load $F_r=2\,500\text{ N}$, (255kgf) and speed $n=900\text{ min}^{-1}$.

The basic load rating C_r of **6208** is $29\,100\text{ N}$, (2 970kgf) (Bearing Table, Page B10). Since only a radial load is applied, the equivalent load P may be obtained as follows:

$$P = F_r = 2\,500\text{ N}, \text{ (255kgf)}$$

Since the speed is $n = 900\text{ min}^{-1}$, the speed factor f_h can be obtained from the equation in Table 5.2 (Page A25) or Fig. 5.3(Page A26).

$$f_h = 0.333$$

The fatigue life factor f_h , under these conditions, can be calculated as follows:

$$f_h = f_h \frac{C_r}{P} = 0.333 \times \frac{29\,100}{2\,500} = 3.88$$

This value is suitable for industrial applications, air conditioners being regularly used, etc., and according to the equation in Table 5.2 or Fig. 5.4 (Page A26), it corresponds approximately to 29 000 hours of service life.

(Example 2)

Select a single-row deep groove ball bearing with a bore diameter of 50 mm and outside diameter under 100 mm that satisfies the following conditions:

Radial load $F_r = 3\,000\text{ N}$, (306kgf)

Speed $n = 1\,900\text{ min}^{-1}$

Basic rating life $L_h \geq 10\,000\text{ h}$

The fatigue life factor f_h of ball bearings with a rating fatigue life longer than 10 000 hours is $f_h \geq 2.72$.

Because $f_h = 0.26$, $P = F_r = 3\,000\text{ N}$, (306kgf)

$$f_h = f_h \frac{C_r}{P} = 0.26 \times \frac{C_r}{3\,000} \geq 2.72$$

therefore, $C_r \geq 2.72 \times \frac{3\,000}{0.26} = 31\,380\text{ N}$, (3 200kgf)

Among the data listed in the bearing table on Page B12, **6210** should be selected as one that satisfies the above conditions.

(Example 3)

Obtain C_r/P or fatigue life factor f_h when an axial load $F_a=1\,000\text{ N}$, (102kgf) is added to the conditions of (Example 1)

When the radial load F_r and axial load F_a are applied on single-row deep groove ball bearing **6208**, the dynamic equivalent load P should be calculated in accordance with the following procedure.

Obtain the radial load factor X , axial load factor Y and constant e obtainable, depending on the magnitude of $f_0 F_a / C_{or}$, from the table above the single-row deep groove ball bearing table.

The basic static load rating C_{or} of ball bearing **6208** is $17\,900\text{ N}$, (1 820kgf) (Page B10)

$$f_0 F_a / C_{or} = 14.0 \times 1\,000 / 17\,900 = 0.782$$

$$e \doteq 0.26$$

and $F_a / F_r = 1\,000 / 2\,500 = 0.4 > e$

$$X = 0.56$$

$Y = 1.67$ (the value of Y is obtained by linear interpolation)

Therefore, the dynamic equivalent load P is

$$\begin{aligned} P &= XF_r + YF_a \\ &= 0.56 \times 2\,500 + 1.67 \times 1\,000 \\ &= 3\,070\text{ N}, \text{ (313kgf)} \end{aligned}$$

$$\frac{C_r}{P} = \frac{29\,100}{3\,070} = 9.48$$

$$f_h = f_h \frac{C_r}{P} = 0.333 \times \frac{29\,100}{3\,070} = 3.16$$

This value of f_h corresponds approximately to 15 800 hours for ball bearings.

(Example 4)

Select a spherical roller bearing of series 231 satisfying the following conditions:

Radial load $F_r = 45\,000\text{ N}$, (4 950kgf)

Axial load $F_a = 8\,000\text{ N}$, (816kgf)

Speed $n = 500\text{ min}^{-1}$

Basic rating life $L_h \geq 30\,000\text{ h}$

The value of the fatigue life factor f_h , which makes $L_h \geq 30\,000\text{ h}$ is bigger than 3.45 from Fig. 5.4 (Page A26).

The dynamic equivalent load P of spherical roller bearings is given by:

when $F_a / F_r \leq e$

$$P = XF_r + YX_a = F_r + Y_3 F_a$$

when $F_a / F_r > e$

$$P = XF_r + YF_a = 0.67 F_r + Y_2 F_a$$

$$F_a / F_r = 8\,000 / 45\,000 = 0.18$$

We can see in the bearing table that the value of e is about 0.3 and that of Y_3 is about 2.2 for bearings of series 231:

$$\begin{aligned} \text{Therefore, } P &= XF_r + YF_a = F_r + Y_3 F_a \\ &= 45\,000 + 2.2 \times 8\,000 \\ &= 62\,600\text{ N}, \text{ (6 380kgf)} \end{aligned}$$

From the fatigue life factor f_h , the basic load rating can be obtained as follows:

$$f_h = f_h \frac{C_r}{P} = 0.444 \times \frac{C_r}{62\,600} \geq 3.45$$

consequently, $C_r \geq 490\,000\text{ N}$, (50 000kgf)

Among spherical roller bearings of series 231 satisfying this value of C_r , the smallest is **23126CE4** ($C_r = 505\,000\text{ N}$, (51 500kgf))

Once the bearing is determined, substitute the value of Y_3 in the equation and obtain the value of P .

$$\begin{aligned} P &= F_r + Y_3 F_a = 45\,000 + 2.4 \times 8\,000 \\ &= 64\,200\text{ N}, \text{ (6 550kgf)} \end{aligned}$$

$$\begin{aligned} L_h &= 500 \left(f_h \frac{C_r}{P} \right)^{\frac{10}{3}} \\ &= 500 \left(0.444 \times \frac{505\,000}{64\,200} \right)^{\frac{10}{3}} \\ &= 500 \times 3.49^{\frac{10}{3}} \doteq 32\,000\text{ h} \end{aligned}$$

(Example 5)

Assume that tapered roller bearings **HR30305DJ** and **HR30206J** are used in a back-to-back arrangement as shown in Fig. 5.14, and the distance between the cup back faces is 50 mm.

Calculate the basic rating life of each bearing when beside the radial load $F_r = 5\,500\text{ N}$, (561kgf), axial load $F_a = 2\,000\text{ N}$, (204kgf) are applied to **HR30305DJ** as shown in Fig. 5.14. The speed is 600 min^{-1} .

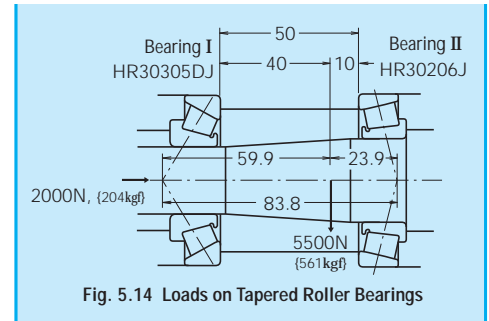

Fig. 5.14 Loads on Tapered Roller Bearings

To distribute the radial load F_r on bearings I and II, the effective load centers must be located for tapered roller bearings. Obtain the effective load center a for bearings I and II from the bearing table, then obtain the relative position of the radial load F_r and effective load centers. The result will be as shown in Fig. 5.14. Consequently, the radial load applied on bearings I (**HR30305DJ**) and II (**HR30206J**) can be obtained from the following equations:

$$F_{rI} = 5\,500 \times \frac{23.9}{83.8} = 1\,569\text{ N}, \text{ (160kgf)}$$

$$F_{rII} = 5\,500 \times \frac{59.9}{83.8} = 3\,931\text{ N}, \text{ (401kgf)}$$

From the data in the bearing table, the following values are obtained:

Bearings	Basic dynamic load rating C_r (N) (kgf)	Axial load factor Y_1	Constant e
Bearing I (HR30305DJ)	38 000 (3 900)	$Y_1 = 0.73$	0.83
Bearing II (HR30206J)	43 000 (4 400)	$Y_1 = 1.6$	0.38

When radial loads are applied on tapered roller bearings, an axial load component is produced, which must be considered to obtain the dynamic equivalent radial load (Refer to Paragraph 5.4.2, Page A31).

$$F_{ae} + \frac{0.6}{Y_{II}} F_{rII} = 2\,000 + \frac{0.6}{1.6} \times 3\,931 = 3\,474\text{N}, \text{ (354kgf)}$$

$$\frac{0.6}{Y_I} F_{rI} = \frac{0.6}{0.73} \times 1\,569 = 1\,290\text{N}, \text{ (132kgf)}$$

Therefore, with this bearing arrangement, the axial load $F_{ae} + \frac{0.6}{Y_{II}} F_{rII}$ is applied on bearing I but not on bearing II.

For bearing I $F_{rI} = 1\,569\text{N}, \text{ (160kgf)}$

$F_{aI} = 3\,474\text{N}, \text{ (354kgf)}$

since $F_{aI} / F_{rI} = 2.2 > e = 0.83$

the dynamic equivalent load $P_1 = XF_{rI} + Y_1 F_{aI}$
 $= 0.4 \times 1\,569 + 0.73 \times 3\,474 = 3\,164\text{N}, \text{ (323kgf)}$

The fatigue life factor $f_h = f_n \frac{C_r}{P_1}$
 $= \frac{0.42 \times 38\,000}{3\,164} = 5.04$

and the rating fatigue life $L_h = 500 \times 5.04^{\frac{10}{3}} = 109\,750\text{h}$

For bearing II since $F_{rII} = 3\,931\text{N}, \text{ (401kgf)}, F_{aII} = 0$

the dynamic equivalent load $P_2 = F_{rII} = 3\,931\text{N}, \text{ (401kgf)}$

the fatigue life factor $f_h = f_n \frac{C_r}{P_2} = \frac{0.42 \times 43\,000}{3\,931} = 4.59$

and the rating fatigue life $L_h = 500 \times 4.59^{\frac{10}{3}} = 80\,400\text{h}$ are obtained.

Remarks For face-to-face arrangements (DF type), please contact NSK.

(Example 6)
 Select a bearing for a speed reducer under the following conditions:
 Operating conditions
 Radial load $F_r = 245\,000\text{N}, \text{ (25\,000kgf)}$
 Axial load $F_a = 49\,000\text{N}, \text{ (5\,000kgf)}$
 Speed $n = 500\text{min}^{-1}$
 Size limitation
 Shaft diameter: 300mm
 Bore of housing: Less than 500mm

In this application, heavy loads, shocks, and shaft deflection are expected; therefore, spherical roller bearings are appropriate. The following spherical roller bearings satisfy the above size limitation (refer to Page B196)

d	D	B	Bearing No.	Basic dynamic load rating		Constant e	Factor Y ₃
				C _r (N)	(kgf)		
300	420	90	23960 CAE4	1 230 000	125 000	0.19	3.5
	460	118	23060 CAE4	1 920 000	196 000	0.24	2.8
	460	160	24060 CAE4	2 310 000	235 000	0.32	2.1
500	160		23160 CAE4	2 670 000	273 000	0.31	2.2
	200		24160 CAE4	3 100 000	315 000	0.38	1.8

since $F_a / F_r = 0.20 < e$
 the dynamic equivalent load P is

$$P = F_r + Y_3 F_a$$

Judging from the fatigue life factor f_h in Table 5.1 and examples of applications (refer to Page A25), a value of f_h , between 3 and 5 seems appropriate.

$$f_h = f_n \frac{C_r}{P} = \frac{0.444 C_r}{F_r + Y_3 F_a} = 3 \text{ to } 5$$

Assuming that $Y_3 = 2.1$, then the necessary basic load rating C_r can be obtained

$$C_r = \frac{(F_r + Y_3 F_a) \times (3 \text{ to } 5)}{0.444} = \frac{(245\,000 + 2.1 \times 49\,000) \times (3 \text{ to } 5)}{0.444} = 2\,350\,000 \text{ to } 3\,900\,000 \text{ N}, \text{ (240\,000 to 400\,000 kgf)}$$

The bearings which satisfy this range are **23160CAE4**, and **24160CAE4**.

6. LIMITING SPEED

The speed of rolling bearings is subject to certain limits. When bearings are operating, the higher the speed, the higher the bearing temperature due to friction. The limiting speed is the empirically obtained value for the maximum speed at which bearings can be continuously operated without failing from seizure or generation of excessive heat. Consequently, the limiting speed of bearings varies depending on such factors as bearing type and size, cage form and material, load, lubricating method, and heat dissipating method including the design of the bearing's surroundings.

The limiting speeds for bearings lubricated by grease and oil are listed in the bearing tables. The limiting speeds in the tables are applicable to bearings of standard design and subjected to normal loads, i. e. $CIP \geq 12$ and $F_a / F_r \leq 0.2$ approximately. The limiting speeds for oil lubrication listed in the bearing tables are for conventional oil bath lubrication. Some types of lubricants are not suitable for high speed, even though they may be markedly superior in other respects. When speeds are more than 70 percent of the listed limiting speed, it is necessary to select an oil or grease which has good high speed characteristics.

- (Refer to) Table 12.2 Grease Properties (Pages A110 and 111)
- Table 12.5 Example of Selection of Lubricant for Bearing Operating Conditions (Page A113)
- Table 15.8 Brands and Properties of Lubricating Grease (Pages A138 to A141)

6.1 Correction of Limiting Speed

When the bearing load P exceeds 8 % of the basic load rating C , or when the axial load F_a exceeds 20 % of the radial load F_r , the limiting speed must be corrected by multiplying the limiting speed found in the bearing tables by the correction factor shown in Figs. 6.1 and 6.2.

When the required speed exceeds the limiting speed of the desired bearing; then the accuracy grade, internal clearance, cage type and material, lubrication, etc., must be carefully studied in order to select a bearing capable of the required speed. In such a case, forced-circulation oil lubrication, jet lubrication, oil mist lubrication, or oil-air lubrication must be used.

If all these conditions are considered. The maximum permissible speed may be corrected by multiplying the limiting speed found in the bearing tables by the correction factor shown in Table 6.1. It is recommended that NSK be consulted regarding high speed applications.

6.2 Limiting Speed for Rubber Contact Seals for Ball Bearings

The maximum permissible speed for contact rubber sealed bearings (DDU type) is determined mainly by the sliding surface speed of the inner circumference of the seal. Values for the limiting speed are listed in the bearing tables.

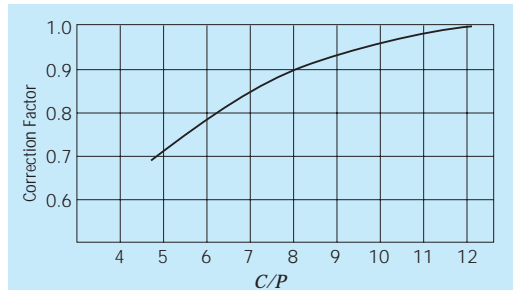

Fig. 6.1 Limiting Speed Correction Factor Variation with Load Ratio

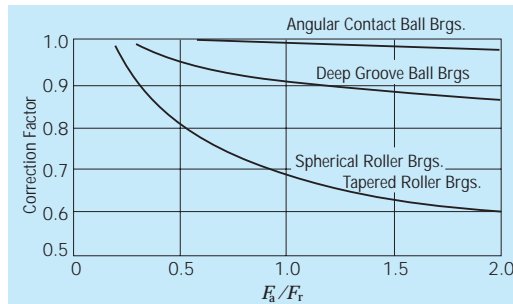

Fig. 6.2 Limiting Speed Correction Factor for Combined Radial and Axial Loads

Table 6.1 Limiting Speed Correction Factor for High-Speed Applications

Bearing Types	Correction Factor
Cylindrical Roller Brgs. (single row)	2
Needle Roller Brgs. (except broad width)	2
Tapered Roller Brgs.	2
Spherical Roller Brgs.	1.5
Deep Groove Ball Brgs.	2.5
Angular Contact Ball Brgs. (except matched bearings)	1.5

7. BOUNDARY DIMENSIONS AND IDENTIFYING NUMBERS FOR BEARINGS

7.1 Boundary Dimensions and Dimensions of Snap Ring Grooves

7.1.1 Boundary Dimensions

The boundary dimensions of rolling bearings, which are shown in Figs.7.1 through 7.5, are the dimensions that define their external geometry. They include bore diameter d , outside diameter D , width B , bearing width(or height) T , chamfer dimension r , etc. It is necessary to know all of these dimensions when mounting a bearing on a shaft and in a housing. These boundary dimensions have been internationally standardized (ISO15) and adopted by JIS B 1512 (Boundary Dimensions of Rolling Bearings).

The boundary dimensions and dimension series of radial bearings, tapered roller bearings, and thrust bearings are listed in Table 7.1 to 7.3 (Pages A40 to A49).

In these boundary dimension tables, for each bore number, which prescribes the bore diameter, other boundary dimensions are listed for each diameter series and dimension series. A very large number of series are possible; however, not all of them are commercially available so more can be added in the future. Across the top of each bearing table (7.1 to 7.3), representative bearing types and series symbols are shown (refer to Table 7.5, Bearing Series Symbols, Page A55).

The relative cross-sectional dimensions of radial bearings (except tapered roller bearings) and thrust bearings for the various series classifications are shown in Figs. 7.6 and 7.7 respectively.

7.1.2 Dimensions of Snap Ring Grooves and Locating Snap Rings

The dimensions of Snap ring grooves in the outer surfaces of bearings are specified by ISO 464. Also, the dimensions and accuracy of the locating snap rings themselves are specified by ISO 464. The dimensions of snap ring grooves and locating snap ring for bearings of diameter series 8, 9, 0, 2, 3, and 4, are shown in Table 7.4 (Pages A50 to A53).

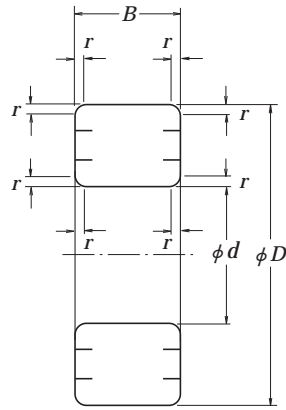

Fig. 7.1 Boundary Dimensions of Radial Ball and Roller Bearings

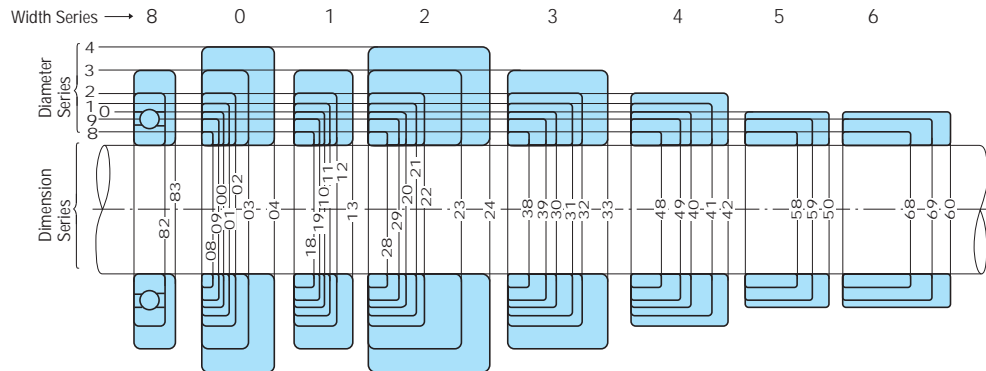

Fig. 7.6 Comparison of Cross Sections of Radial Bearings (except Tapered Roller Bearings) for various Dimensional Series

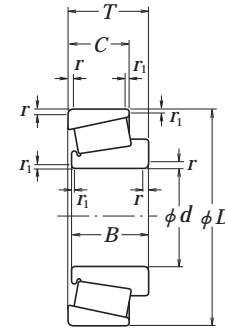

Fig. 7.2 Tapered Roller Bearings

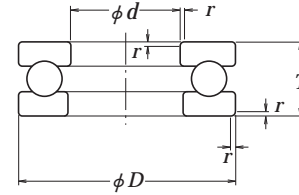

Fig. 7.3 Single-Direction Thrust Ball Bearings

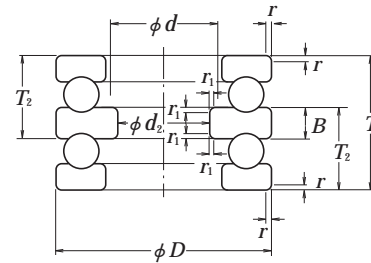

Fig. 7.4 Double-Direction Thrust Ball Bearings

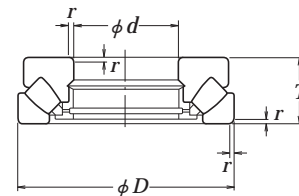

Fig. 7.5 Spherical Thrust Roller Bearings

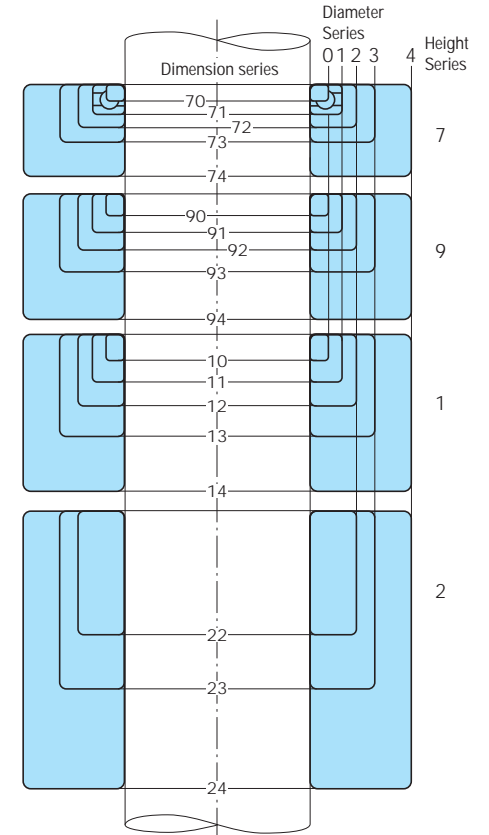

Fig. 7.7 Comparison of Cross Sections of Thrust Bearings (except Diameter Series 5) for Various Dimension Series

Table 7. 1 Boundary Dimensions of Radial Bearings (except Tapered Roller Bearings) — 1 —

Bore Number	Diameter Series 7										Diameter Series 8										Diameter Series 9										Diameter Series 0									
	Dimension Series					Dimension Series					Dimension Series					Dimension Series					Dimension Series					Dimension Series					Dimension Series									
	D	17	27	37	17~37	D	08	18	28	38	48	58	68	08	18~68	D	09	19	29	39	49	59	69	09	19~39	49~69	D	00	10	20	30	40	50	60	00	10~60				
1	0.6	2.08	1.5	3	0.05	2.5	1	1	1.4	1.5	2	0.05	0.05	0.05	4	13	20	24	30	37	44	51	58	65	72	79	86	93	100	107	114	121	128	135	142	149	156			
2	1.5	3	1.8	3	0.05	3	1	1.2	2	2	2	0.05	0.05	0.05	5	14	21	28	35	42	49	56	63	70	77	84	91	98	105	112	119	126	133	140	147	154	161	168		
3	2.5	4.12	2.3	4	0.08	4	1.5	2.3	3	3	3	0.08	0.08	0.08	6	15	22	29	36	43	50	57	64	71	78	85	92	99	106	113	120	127	134	141	148	155	162	169		
4	3	5.15	3.3	5	0.08	5	2	2.6	4	4	4	0.1	0.1	0.1	7	16	23	30	37	44	51	58	65	72	79	86	93	100	107	114	121	128	135	142	149	156	163	170		
5	4	7.2	4.5	7	0.08	6	2.5	3.5	5	5	5	0.15	0.15	0.15	8	17	24	31	38	45	52	59	66	73	80	87	94	101	108	115	122	129	136	143	150	157	164	171		
6	5	8.2	5.5	8	0.1	9	3.4	4.5	6	6	6	0.15	0.15	0.15	9	18	25	32	39	46	53	60	67	74	81	88	95	102	109	116	123	130	137	144	151	158	165	172		
7	6	10.25	6.5	10	0.1	10	3.5	5	7	7	7	0.15	0.15	0.15	10	19	26	33	40	47	54	61	68	75	82	89	96	103	110	117	124	131	138	145	152	159	166	173		
8	7	11.25	7.5	11	0.15	11	3.5	5	8	8	8	0.2	0.2	0.2	11	20	27	34	41	48	55	62	69	76	83	90	97	104	111	118	125	132	139	146	153	160	167	174		
9	8	12.25	8.5	12	0.15	12	4	5	9	9	9	0.2	0.2	0.2	12	21	28	35	42	49	56	63	70	77	84	91	98	105	112	119	126	133	140	147	154	161	168	175		
10	9	14.3	9.5	14	0.15	13	4.5	6	10	10	10	0.2	0.2	0.2	13	22	29	36	43	50	57	64	71	78	85	92	99	106	113	120	127	134	141	148	155	162	169	176		
11	10	15.3	10.5	15	0.2	14	5	6	11	11	11	0.2	0.2	0.2	14	23	30	37	44	51	58	65	72	79	86	93	100	107	114	121	128	135	142	149	156	163	170	177		
12	11	17.3	11.5	17	0.2	15	5.5	7	12	12	12	0.2	0.2	0.2	15	24	31	38	45	52	59	66	73	80	87	94	101	108	115	122	129	136	143	150	157	164	171	178		
13	12	19.3	12.5	19	0.2	16	6	8	13	13	13	0.2	0.2	0.2	16	25	32	39	46	53	60	67	74	81	88	95	102	109	116	123	130	137	144	151	158	165	172	179		
14	13	21.3	13.5	21	0.2	17	6.5	9	14	14	14	0.2	0.2	0.2	17	26	33	40	47	54	61	68	75	82	89	96	103	110	117	124	131	138	145	152	159	166	173	180		
15	14	23.3	14.5	23	0.2	18	7	10	15	15	15	0.2	0.2	0.2	18	27	34	41	48	55	62	69	76	83	90	97	104	111	118	125	132	139	146	153	160	167	174	181		
16	15	25.3	15.5	25	0.2	19	7.5	11	16	16	16	0.2	0.2	0.2	19	28	35	42	49	56	63	70	77	84	91	98	105	112	119	126	133	140	147	154	161	168	175	182		
17	16	27.3	16.5	27	0.2	20	8	12	17	17	17	0.2	0.2	0.2	20	29	36	43	50	57	64	71	78	85	92	99	106	113	120	127	134	141	148	155	162	169	176	183		
18	17	29.3	17.5	29	0.2	21	8.5	13	18	18	18	0.2	0.2	0.2	21	30	37	44	51	58	65	72	79	86	93	100	107	114	121	128	135	142	149	156	163	170	177	184		
19	18	31.3	18.5	31	0.2	22	9	14	19	19	19	0.2	0.2	0.2	22	31	38	45	52	59	66	73	80	87	94	101	108	115	122	129	136	143	150	157	164	171	178	185		
20	19	33.3	19.5	33	0.2	23	9.5	15	20	20	20	0.2	0.2	0.2	23	32	39	46	53	60	67	74	81	88	95	102	109	116	123	130	137	144	151	158	165	172	179	186		
21	105	130	140	150	160	170	180	190	200	210	220	230	240	250	260	270	280	290	300	310	320	330	340	350	360	370	380	390	400	410	420	430	440	450	460	470	480			
22	110	135	145	155	165	175	185	195	205	215	225	235	245	255	265	275	285	295	305	315	325	335	345	355	365	375	385	395	405	415	425	435	445	455	465	475	485			
23	115	140	150	160	170	180	190	200	210	220	230	240	250	260	270	280	290	300	310	320	330	340	350	360	370	380	390	400	410	420	430	440	450	460	470	480	490			
24	120	145	155	165	175	185	195	205	215	225	235	245	255	265	275	285	295	305	315	325	335	345	355	365	375	385	395	405	415	425	435	445	455	465	475	485	495			
25	125	150	160	170	180	190	200	210	220	230	240	250	260	270	280	290	300	310	320	330	340	350	360	370	380	390	400	410	420	430	440	450	460	470	480	490	500			
26	130	155	165	175	185	195	205	215	225	235	245	255	265	275	285	295	305	315	325	335	345	355	365	375	385	395	405	415	425	435	445	455	465	475	485	495	505			
27	135	160	170	180	190	200	210	220	230	240	250	260	270	280	290	300	310	320	330	340	350	360	370	380	390	400	410	420	430	440	450	460	470	480	490	500	510			
28	140	165	175	185	195	205	215	225	235	245	255	265	275	285	295	305	315	325	335	345	355	365	375	385	395	405	415	425	435	445	455	465	475	485	495	505	515			
29	145	170	180	190	200	210	220	230	240	250	260	270	280	290	300	310	320	330	340	350	360	370	380	390	400	410	420	430	440	450	460	470	480	490	500	510	520			
30	150	175	185	195	205	215	225	235	245	255	265	275	285	295	305	315	325	335	345	355	365	375	385	395	405	415	425	435	445	455	465	475	485	495	505	515	525			
31	155	180	190	200	210	220	230	240	250	260	270	280	290	300	310	320	330	340	350	360	370	380	390	400	410	420	430	440	450	460	470	480	490	500	510	520	530			
32	160	185	195	205	215	225	235	245	255	265	275	285	295	305	315	325	335	345	355	365	375	385	395	405	415	425	435	445	455	465	475	485	495	505	515	525	535			
33	165	190	200	210	220	230	240	250	260	270	280	290	300	310	320	330	340	350	360	370	380	390	400	410	420	430	440	450	460	470	480	490	500	510	520	530	540			
34	170	195	205	215	225	235	245	255	265	275	285	295	305	315	325	335	345	355	365	375	385	395	405	415	425	435	445	455	465	475	485	495	505	515	525	535	545			
35	175	200	210	220	230	240	250	260	270	280	290	300	310	320																										

Table 7. 3 Boundary Dimensions of

Thrust Ball Brgs.								511						512		522							
Spherical Thrust Roller Brgs.										292													
Bore Number	<i>d</i>	Diameter Series 0					Diameter Series 1					Diameter Series 2										<i>r</i> (min.)	<i>r</i> ₁ (min.)
		Dimension Series			<i>r</i> (min.)	Dimension Series			<i>r</i> (min.)	Dimension Series					<i>r</i> (min.)	<i>r</i> ₁ (min.)							
		<i>D</i>	70	90		10	<i>D</i>	71		91	11	<i>D</i>	72	92			12	22	22				
		<i>T</i>				<i>T</i>				<i>T</i>							Central Washer						
											<i>d</i> ₂	<i>B</i>											
4	4	12	4	—	6	0.3	—	—	—	—	16	6	—	8	—	—	—	0.3	—				
6	6	16	5	—	7	0.3	—	—	—	—	20	6	—	9	—	—	—	0.3	—				
8	8	18	5	—	7	0.3	—	—	—	—	22	6	—	9	—	—	—	0.3	—				
00	10	20	5	—	7	0.3	24	6	—	9	0.3	26	7	—	11	—	—	0.6	—				
01	12	22	5	—	7	0.3	26	6	—	9	0.3	28	7	—	11	—	—	0.6	—				
02	15	26	5	—	7	0.3	28	6	—	9	0.3	32	8	—	12	22	10	5	0.6	0.3			
03	17	28	5	—	7	0.3	30	6	—	9	0.3	35	8	—	12	—	—	0.6	—				
04	20	32	6	—	8	0.3	35	7	—	10	0.3	40	9	—	14	26	15	6	0.6	0.3			
05	25	37	6	—	8	0.3	42	8	—	11	0.6	47	10	—	15	28	20	7	0.6	0.3			
06	30	42	6	—	8	0.3	47	8	—	11	0.6	52	10	—	16	29	25	7	0.6	0.3			
07	35	47	6	—	8	0.3	52	8	—	12	0.6	62	12	—	18	34	30	8	1	0.3			
08	40	52	6	—	9	0.3	60	9	—	13	0.6	68	13	—	19	36	30	9	1	0.6			
09	45	60	7	—	10	0.3	65	9	—	14	0.6	73	13	—	20	37	35	9	1	0.6			
10	50	65	7	—	10	0.3	70	9	—	14	0.6	78	13	—	22	39	40	9	1	0.6			
11	55	70	7	—	10	0.3	78	10	—	16	0.6	90	16	—	25	45	45	10	1	0.6			
12	60	75	7	—	10	0.3	85	11	—	17	1	95	16	21	26	46	50	10	1	0.6			
13	65	80	7	—	10	0.3	90	11	—	18	1	100	16	21	27	47	55	10	1	0.6			
14	70	85	7	—	10	0.3	95	11	—	18	1	105	16	21	27	47	55	10	1	1			
15	75	90	7	—	10	0.3	100	11	—	19	1	110	16	21	27	47	60	10	1	1			
16	80	95	7	—	10	0.3	105	11	—	19	1	115	16	21	28	48	65	10	1	1			
17	85	100	7	—	10	0.3	110	11	—	19	1	125	18	24	31	55	70	12	1	1			
18	90	105	7	—	10	0.3	120	14	—	22	1	135	20	27	35	62	75	14	1.1	1			
20	100	120	9	—	14	0.6	135	16	21	25	1	150	23	30	38	67	85	15	1.1	1			
22	110	130	9	—	14	0.6	145	16	21	25	1	160	23	30	38	67	95	15	1.1	1			
24	120	140	9	—	14	0.6	155	16	21	25	1	170	23	30	39	68	100	15	1.1	1.1			
26	130	150	9	—	14	0.6	170	18	24	30	1	190	27	36	45	80	110	18	1.5	1.1			
28	140	160	9	—	14	0.6	180	18	24	31	1	200	27	36	46	81	120	18	1.5	1.1			
30	150	170	9	—	14	0.6	190	18	24	31	1	215	29	39	50	89	130	20	1.5	1.1			
32	160	180	9	—	14	0.6	200	18	24	31	1	225	29	39	51	90	140	20	1.5	1.1			
34	170	190	9	—	14	0.6	215	20	27	34	1.1	240	32	42	55	97	150	21	1.5	1.1			
36	180	200	9	—	14	0.6	225	20	27	34	1.1	250	32	42	56	98	150	21	1.5	2			
38	190	215	11	—	17	1	240	23	30	37	1.1	270	36	48	62	109	160	24	2	2			
40	200	225	11	—	17	1	250	23	30	37	1.1	280	36	48	62	109	170	24	2	2			
44	220	250	14	—	22	1	270	23	30	37	1.1	300	36	48	63	110	190	24	2	2			
48	240	270	14	—	22	1	300	27	36	45	1.5	340	45	60	78	—	—	—	2.1	—			
52	260	290	14	—	22	1	320	27	36	45	1.5	360	45	60	79	—	—	—	2.1	—			
56	280	310	14	—	22	1	350	32	42	53	1.5	380	45	60	80	—	—	—	2.1	—			
60	300	340	18	24	30	1	380	36	48	62	2	420	54	73	95	—	—	—	3	—			
64	320	360	18	24	30	1	400	36	48	63	2	440	54	73	95	—	—	—	3	—			

Remarks 1. Dimension Series 22, 23, and 24 are double direction bearings.
 2. The maximum permissible outside diameter of shaft and central washers and minimum permissible bore diameter of housing washers are omitted here. (Refer to the bearing tables for Thrust Bearings).

Thrust Bearings (Flat Seats) — 1 —

				513		523						514		524						Units: mm					
				293						294										Thrust Ball Brgs.					
																				Spherical Thrust Roller Brgs.					
Bore Number	<i>d</i>	Diameter Series 3										Diameter Series 4										Diameter Series 5		<i>d</i>	Bore Number
		Dimension Series					<i>r</i> (min.)	<i>r</i> ₁ (min.)	Dimension Series					<i>r</i> (min.)	<i>r</i> ₁ (min.)	Dimension Series 95	<i>r</i> (min.)								
		<i>D</i>	73	93	13	23			23	<i>D</i>	74	94	14					24	24	<i>D</i>	95				
		<i>T</i>							Central Washer		<i>T</i>							Central Washer							
					<i>d</i> ₂	<i>B</i>						<i>d</i> ₂	<i>B</i>												
20	7	—	11	—	—	—	0.6	—	—	—	—	—	—	—	—	—	—	—	—	4	4				
24	8	—	12	—	—	—	0.6	—	—	—	—	—	—	—	—	—	—	—	—	6	6				
26	8	—	12	—	—	—	0.6	—	—	—	—	—	—	—	—	—	—	—	—	8	8				
30	9	—	14	—	—	—	0.6	—	—	—	—	—	—	—	—	—	—	—	—	10	00				
32	9	—	14	—	—	—	0.6	—	—	—	—	—	—	—	—	—	—	—	—	12	01				
37	10	—	15	—	—	—	0.6	—	—	—	—	—	—	—	—	—	—	—	—	15	02				
40	10	—	16	—	—	—	0.6	—	—	—	—	—	—	—	—	—	—	—	—	17	03				
47	12	—	18	—	—	—	1	—	—	—	—	—	—	—	—	—	—	—	—	20	04				
52	12	—	18	34	20	8	1	0.3	60	16	21	24	45	15	11	1	0.6	73	29	1.1	25	05			
60	14	—	21	38	25	9	1	0.3	70	18	24	28	52	20	12	1	0.6	85	34	1.1	30	06			
68	15	—	24	44	30	10	1	0.3	80	20	27	32	59	25	14	1.1	0.6	100	39	1.1	35	07			
78	17	22	26	49	30	12	1	0.6	90	23	30	36	65	30	15	1.1	0.6	110	42	1.5	40	08			
85	18	24	28	52	35	12	1	0.6	100	25	34	39	72	35	17	1.1	0.6	120	45	2	45	09			
95	20	27	31	58	40	14	1.1	0.6	110	27	36	43	78	40	18	1.5	0.6	135	51	2	50	10			
105	23	30	35	64	45	15	1.1	0.6	120	29	39	48	87	45	20	1.5	0.6	150	58	2.1	55	11			
110	23	30	35	64	50	15	1.1	0.6	130	32	42	51	93	50	21	1.5	0.6	160	60	2.1	60	12			
115	23	30	36	65	55	15	1.1	0.6	140	34	45	56	101	50	23	2	1	170	63	2.1	65	13			
125	25	34	40	72	55	16	1.1	1	150	36	48	60	107	55	24	2	1	180	67	3	70	14			
135	27	36	44	79	60	18	1.5	1	160	38	51	65	115	60	26	2	1	190	69	3	75	15			
140	27	36	44	79	65	18	1.5	1	170	41	54	68	120	65	27	2.1	1	200	73	3	80	16			
150	29	39	49	87	70	19	1.5	1	180	42	58	72	128	65	29	2.1	1.1	215	78	4	85	17			
155	29	39	50	88	75	19	1.5	1	190	45	60	77	135	70	30	2.1	1.1	225	82	4	90	18			
170	32	42	55	97	85	21	1.5	1	210	50	67	85	150	80	33	3	1.1	250	90	4	100	20			
190	36	48	63	110	95	24	2	1	230	54	73	95	166	90	37	3	1.1	270	95	5	110	22			
210	41	54	70	123	100	27	2.1	1.1	250	58	78	102	177	95	40	4	1.5	300	109	5	120	24			
225	42	58	75	130	110	30	2.1	1.1	270	63	85	110	192	100	42	4	2	320	115	5	130	26			
240	45	60	80	140	120	31	2.1	1.1	280	63	85	112	196	110	44	4	2	340	122	5	140	28			
250	45	60	80	140	130	31	2.1	1.1	300	67	90	120</													

Table 7. 3 Boundary Dimensions of

Thrust Ball Brgs.								511						512		522					
Spherical Thrust Roller Brgs.										292											
Bore Number	d	Diameter Series 0					Diameter Series 1					Diameter Series 2									
		Dimension Series			r ₁ (min.)	D	Dimension Series			r ₁ (min.)	D	Dimension Series					r ₁ (min.)	r ₁ (min.)			
		70	90	10			71	91	11			72	92	12	22	22					
		T					T					T							Central Washer		
											d ₂	B									
68	340	380	18	24	30	1	420	36	48	64	2	460	54	73	96	—	—	—	3	—	
72	360	400	18	24	30	1	440	36	48	65	2	500	63	85	110	—	—	—	4	—	
76	380	420	18	24	30	1	460	36	48	65	2	520	63	85	112	—	—	—	4	—	
80	400	440	18	24	30	1	480	36	48	65	2	540	63	85	112	—	—	—	4	—	
84	420	460	18	24	30	1	500	36	48	65	2	580	73	95	130	—	—	—	5	—	
88	440	480	18	24	30	1	540	45	60	80	2.1	600	73	95	130	—	—	—	5	—	
92	460	500	18	24	30	1	560	45	60	80	2.1	620	73	95	130	—	—	—	5	—	
96	480	520	18	24	30	1	580	45	60	80	2.1	650	78	103	135	—	—	—	5	—	
/500	500	540	18	24	30	1	600	45	60	80	2.1	670	78	103	135	—	—	—	5	—	
/530	530	580	23	30	38	1.1	640	50	67	85	3	710	82	109	140	—	—	—	5	—	
/560	560	610	23	30	38	1.1	670	50	67	85	3	750	85	115	150	—	—	—	5	—	
/600	600	650	23	30	38	1.1	710	50	67	85	3	800	90	122	160	—	—	—	5	—	
/630	630	680	23	30	38	1.1	750	54	73	95	3	850	100	132	175	—	—	—	6	—	
/670	670	730	27	36	45	1.5	800	58	78	105	4	900	103	140	180	—	—	—	6	—	
/710	710	780	32	42	53	1.5	850	63	85	112	4	950	109	145	190	—	—	—	6	—	
/750	750	820	32	42	53	1.5	900	67	90	120	4	1000	112	150	195	—	—	—	6	—	
/800	800	870	32	42	53	1.5	950	67	90	120	4	1060	118	155	205	—	—	—	7.5	—	
/850	850	920	32	42	53	1.5	1000	67	90	120	4	1120	122	160	212	—	—	—	7.5	—	
/900	900	980	36	48	63	2	1060	73	95	130	5	1180	125	170	220	—	—	—	7.5	—	
/950	950	1030	36	48	63	2	1120	78	103	135	5	1250	136	180	236	—	—	—	7.5	—	
/1000	1000	1090	41	54	70	2.1	1180	82	109	140	5	1320	145	190	250	—	—	—	9.5	—	
/1060	1060	1150	41	54	70	2.1	1250	85	115	150	5	1400	155	206	265	—	—	—	9.5	—	
/1120	1120	1220	45	60	80	2.1	1320	90	122	160	5	1460	—	206	—	—	—	—	9.5	—	
/1180	1180	1280	45	60	80	2.1	1400	100	132	175	6	1520	—	206	—	—	—	—	9.5	—	
/1250	1250	1360	50	67	85	3	1460	—	—	175	6	1610	—	216	—	—	—	—	9.5	—	
/1320	1320	1440	—	—	95	3	1540	—	—	175	6	1700	—	228	—	—	—	—	9.5	—	
/1400	1400	1520	—	—	95	3	1630	—	—	180	6	1790	—	234	—	—	—	—	12	—	
/1500	1500	1630	—	—	105	4	1750	—	—	195	6	1920	—	252	—	—	—	—	12	—	
/1600	1600	1730	—	—	105	4	1850	—	—	195	6	2040	—	264	—	—	—	—	15	—	
/1700	1700	1840	—	—	112	4	1970	—	—	212	7.5	2160	—	276	—	—	—	—	15	—	
/1800	1800	1950	—	—	120	4	2080	—	—	220	7.5	2280	—	288	—	—	—	—	15	—	
/1900	1900	2060	—	—	130	5	2180	—	—	220	7.5	—	—	—	—	—	—	—	—	—	
/2000	2000	2160	—	—	130	5	2300	—	—	236	7.5	—	—	—	—	—	—	—	—	—	
/2120	2120	2300	—	—	140	5	2430	—	—	243	7.5	—	—	—	—	—	—	—	—	—	
/2240	2240	2430	—	—	150	5	2570	—	—	258	9.5	—	—	—	—	—	—	—	—	—	
/2360	2360	2550	—	—	150	5	2700	—	—	265	9.5	—	—	—	—	—	—	—	—	—	
/2500	2500	2700	—	—	160	5	2850	—	—	272	9.5	—	—	—	—	—	—	—	—	—	

Remarks 1. Dimension Series 22, 23, and 24 are double direction bearings.
 2. The maximum permissible outside diameter of shaft and central washers and minimum permissible bore diameter of housing washers are omitted here. (Refer to the bearings tables for Thrust Bearings).

Thrust Bearings (Flat Seats) — 2 —

								513		523						514		524						Units: mm	
										293				294										Thrust Ball Brgs.	
																								Spherical Thrust Roller Brgs.	
Bore Number	d	Diameter Series 3										Diameter Series 4										Diameter Series 5			
		Dimension Series					r ₁ (min.)	r ₁ (min.)	Dimension Series					r ₁ (min.)	r ₁ (min.)	D	Dimension Series 95	r ₁ (min.)	d	Bore Number					
		73	93	13	23	23			74	94	14	24	24												
		T							Central Washer		T										Central Washer				
					d ₂	B						d ₂	B												
540	90	122	160	—	—	—	5	—	620	125	170	220	—	—	—	7.5	—	750	243	12	340	68			
560	90	122	160	—	—	—	5	—	640	125	170	220	—	—	—	7.5	—	780	250	12	360	72			
600	100	132	175	—	—	—	6	—	670	132	175	224	—	—	—	7.5	—	820	265	12	380	76			
620	100	132	175	—	—	—	6	—	710	140	185	243	—	—	—	7.5	—	850	272	12	400	80			
650	103	140	180	—	—	—	6	—	730	140	185	243	—	—	—	7.5	—	900	290	15	420	84			
680	109	145	190	—	—	—	6	—	780	155	206	265	—	—	—	9.5	—	950	308	15	440	88			
710	112	150	195	—	—	—	6	—	800	155	206	265	—	—	—	9.5	—	980	315	15	460	92			
730	112	150	195	—	—	—	6	—	850	165	224	290	—	—	—	9.5	—	1000	315	15	480	96			
750	112	150	195	—	—	—	6	—	870	165	224	290	—	—	—	9.5	—	1060	335	15	500	/500			
800	122	160	212	—	—	—	7.5	—	920	175	236	308	—	—	—	9.5	—	1090	335	15	530	/530			
850	132	175	224	—	—	—	7.5	—	980	190	250	335	—	—	—	12	—	1150	355	15	560	/560			
900	136	180	236	—	—	—	7.5	—	1030	195	258	335	—	—	—	12	—	1220	375	15	600	/600			
950	145	190	250	—	—	—	9.5	—	1090	206	280	365	—	—	—	12	—	1280	388	15	630	/630			
1000	150	200	258	—	—	—	9.5	—	1150	218	290	375	—	—	—	15	—	1320	388	15	670	/670			
1060	160	212	272	—	—	—	9.5	—	1220	230	308	400	—	—	—	15	—	1400	412	15	710	/710			
1120	165	224	290	—	—	—	9.5	—	1280	236	315	412	—	—	—	15	—	—	—	—	750	/750			
1180	170	230	300	—	—	—	9.5	—	1360	250	335	438	—	—	—	15	—	—	—	—	800	/800			
1250	180	243	315	—	—	—	12	—	1440	243	354	—	—	—	—	15	—	—	—	—	850	/850			
1320	190	250	335	—	—	—	12	—	1520	—	372	—	—	—	—	15	—	—	—	—	900	/900			
1400	200	272	355	—	—	—	12	—	1600	—	390	—	—	—	—	15	—	—	—	—	950	/950			
1460	—	276	—	—	—	—	12	—	1670	—	402	—	—	—	—	15	—								

Table 7. 4 Dimensions of Snap Ring Grooves and Locating Snap Rings — (1)
Bearings of Dimension Series 18 and 19

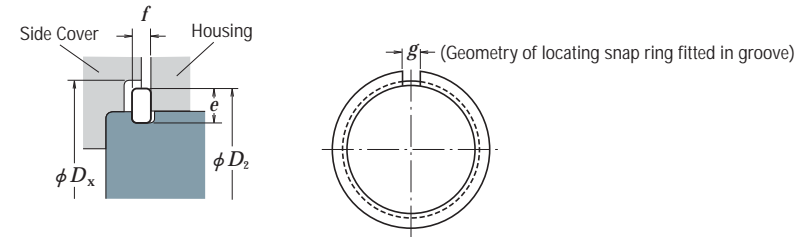
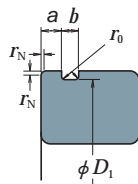

Units: mm

Applicable Bearings		Snap Ring Groove									
Dimension Series	<i>d</i>	<i>D</i>	Snap Ring Groove Diameter <i>D</i> ₁		Snap Ring Groove Position <i>a</i>				Snap Ring Groove Width <i>b</i>		Radius of Bottom Corners <i>r</i> ₀
			max.	min.	Bearing Dimension Series				max.	min.	
					18		19				
18	19			max.	min.	max.	min.	max.	min.	max.	
—	10	22	20.8	20.5	—	—	1.05	0.9	1.05	0.8	0.2
—	12	24	22.8	22.5	—	—	1.05	0.9	1.05	0.8	0.2
—	15	28	26.7	26.4	—	—	1.3	1.15	1.2	0.95	0.25
—	17	30	28.7	28.4	—	—	1.3	1.15	1.2	0.95	0.25
20	—	32	30.7	30.4	1.3	1.15	—	—	1.2	0.95	0.25
22	—	34	32.7	32.4	1.3	1.15	—	—	1.2	0.95	0.25
25	20	37	35.7	35.4	1.3	1.15	1.7	1.55	1.2	0.95	0.25
—	22	39	37.7	37.4	—	—	1.7	1.55	1.2	0.95	0.25
28	—	40	38.7	38.4	1.3	1.15	—	—	1.2	0.95	0.25
30	25	42	40.7	40.4	1.3	1.15	1.7	1.55	1.2	0.95	0.25
32	—	44	42.7	42.4	1.3	1.15	—	—	1.2	0.95	0.25
—	28	45	43.7	43.4	—	—	1.7	1.55	1.2	0.95	0.25
35	30	47	45.7	45.4	1.3	1.15	1.7	1.55	1.2	0.95	0.25
40	32	52	50.7	50.4	1.3	1.15	1.7	1.55	1.2	0.95	0.25
—	35	55	53.7	53.4	—	—	1.7	1.55	1.2	0.95	0.25
45	—	58	56.7	56.4	1.3	1.15	—	—	1.2	0.95	0.25
—	40	62	60.7	60.3	—	—	1.7	1.55	1.2	0.95	0.25
50	—	65	63.7	63.3	1.3	1.15	—	—	1.2	0.95	0.25
—	45	68	66.7	66.3	—	—	1.7	1.55	1.2	0.95	0.25
55	50	72	70.7	70.3	1.7	1.55	1.7	1.55	1.2	0.95	0.25
60	—	78	76.2	75.8	1.7	1.55	—	—	1.6	1.3	0.4
—	55	80	77.9	77.5	—	—	2.1	1.9	1.6	1.3	0.4
65	60	85	82.9	82.5	1.7	1.55	2.1	1.9	1.6	1.3	0.4
70	65	90	87.9	87.5	1.7	1.55	2.1	1.9	1.6	1.3	0.4
75	—	95	92.9	92.5	1.7	1.55	—	—	1.6	1.3	0.4
80	70	100	97.9	97.5	1.7	1.55	2.5	2.3	1.6	1.3	0.4
—	75	105	102.6	102.1	—	—	2.5	2.3	1.6	1.3	0.4
85	80	110	107.6	107.1	2.1	1.9	2.5	2.3	1.6	1.3	0.4
90	—	115	112.6	112.1	2.1	1.9	—	—	1.6	1.3	0.4
95	85	120	117.6	117.1	2.1	1.9	3.3	3.1	1.6	1.3	0.4
100	90	125	122.6	122.1	2.1	1.9	3.3	3.1	1.6	1.3	0.4
105	95	130	127.6	127.1	2.1	1.9	3.3	3.1	1.6	1.3	0.4
110	100	140	137.6	137.1	2.5	2.3	3.3	3.1	2.2	1.9	0.6
—	105	145	142.6	142.1	—	—	3.3	3.1	2.2	1.9	0.6
120	110	150	147.6	147.1	2.5	2.3	3.3	3.1	2.2	1.9	0.6
130	120	165	161.8	161.3	3.3	3.1	3.7	3.5	2.2	1.9	0.6
140	—	175	171.8	171.3	3.3	3.1	—	—	2.2	1.9	0.6
—	130	180	176.8	176.3	—	—	3.7	3.5	2.2	1.9	0.6
150	140	190	186.8	186.3	3.3	3.1	3.7	3.5	2.2	1.9	0.6
160	—	200	196.8	196.3	3.3	3.1	—	—	2.2	1.9	0.6

Locating Snap Ring Number	Locating Snap Ring				Geometry of snap ring fitted in groove (Reference)		Stepped Bore Diameter (Reference) <i>D</i> _x
	Cross Sectional Height <i>e</i>		Thickness <i>f</i>		Slit Width <i>g</i>	Snap Ring Outside Diameter <i>D</i> ₂	
	max.	min.	max.	min.			
NR 1022	2.0	1.85	0.7	0.6	2	24.8	25.5
NR 1024	2.0	1.85	0.7	0.6	2	26.8	27.5
NR 1028	2.05	1.9	0.85	0.75	3	30.8	31.5
NR 1030	2.05	1.9	0.85	0.75	3	32.8	33.5
NR 1032	2.05	1.9	0.85	0.75	3	34.8	35.5
NR 1034	2.05	1.9	0.85	0.75	3	36.8	37.5
NR 1037	2.05	1.9	0.85	0.75	3	39.8	40.5
NR 1039	2.05	1.9	0.85	0.75	3	41.8	42.5
NR 1040	2.05	1.9	0.85	0.75	3	42.8	43.5
NR 1042	2.05	1.9	0.85	0.75	3	44.8	45.5
NR 1044	2.05	1.9	0.85	0.75	4	46.8	47.5
NR 1045	2.05	1.9	0.85	0.75	4	47.8	48.5
NR 1047	2.05	1.9	0.85	0.75	4	49.8	50.5
NR 1052	2.05	1.9	0.85	0.75	4	54.8	55.5
NR 1055	2.05	1.9	0.85	0.75	4	57.8	58.5
NR 1058	2.05	1.9	0.85	0.75	4	60.8	61.5
NR 1062	2.05	1.9	0.85	0.75	4	64.8	65.5
NR 1065	2.05	1.9	0.85	0.75	4	67.8	68.5
NR 1068	2.05	1.9	0.85	0.75	5	70.8	72
NR 1072	2.05	1.9	0.85	0.75	5	74.8	76
NR 1078	3.25	3.1	1.12	1.02	5	82.7	84
NR 1080	3.25	3.1	1.12	1.02	5	84.4	86
NR 1085	3.25	3.1	1.12	1.02	5	89.4	91
NR 1090	3.25	3.1	1.12	1.02	5	94.4	96
NR 1095	3.25	3.1	1.12	1.02	5	99.4	101
NR 1100	3.25	3.1	1.12	1.02	5	104.4	106
NR 1105	4.04	3.89	1.12	1.02	5	110.7	112
NR 1110	4.04	3.89	1.12	1.02	5	115.7	117
NR 1115	4.04	3.89	1.12	1.02	5	120.7	122
NR 1120	4.04	3.89	1.12	1.02	7	125.7	127
NR 1125	4.04	3.89	1.12	1.02	7	130.7	132
NR 1130	4.04	3.89	1.12	1.02	7	135.7	137
NR 1140	4.04	3.89	1.7	1.6	7	145.7	147
NR 1145	4.04	3.89	1.7	1.6	7	150.7	152
NR 1150	4.04	3.89	1.7	1.6	7	155.7	157
NR 1165	4.85	4.7	1.7	1.6	7	171.5	173
NR 1175	4.85	4.7	1.7	1.6	10	181.5	183
NR 1180	4.85	4.7	1.7	1.6	10	186.5	188
NR 1190	4.85	4.7	1.7	1.6	10	196.5	198
NR 1200	4.85	4.7	1.7	1.6	10	206.5	208

Remarks The minimum permissible chamfer dimensions *r*_N on the snap-ring-groove side of the outer rings are as follows:

Dimension series 18 : For outside diameters of 78mm and less, use 0.3mm chamfer.

For all others exceeding 78mm, use 0.5mm chamfer.

Dimension series 19 : For outside diameters of 24mm and less, use 0.2mm chamfer.

For 47mm and less, use 0.3mm chamfer.

For all others exceeding 47mm, use 0.5mm chamfer (However, for an outside diameter of 68 mm, use a 0.3 mm chamfer, which is not compliant with ISO 15).

Table 7. 4 Dimensions of Snap Ring Grooves and Locating Snap Rings — (2)
Bearing of Diameter Series 0, 2, 3, and 4

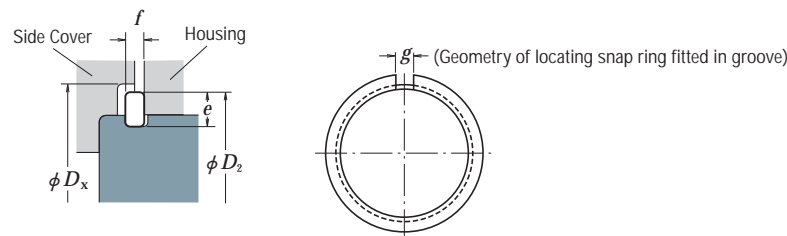
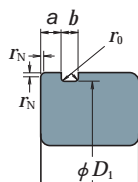

Units: mm

Applicable Bearings				Snap Ring Groove									
<i>d</i>				<i>D</i>	Snap Ring Groove Diameter <i>D</i> ₁		Snap Ring Groove Position <i>a</i>				Snap Ring Groove Width <i>b</i>		Radius of Bottom Corners <i>r</i> ₀
							Bearing Diameter Series						
Diameter Series				max.	min.	0		2, 3, 4		max.	min.	max.	
0	2	3	4			max.	min.	max.	min.				
10	—	—	—	26	24.5	24.25	1.35	1.19	—	—	1.17	0.87	0.2
12	—	—	—	28	26.5	26.25	1.35	1.19	—	—	1.17	0.87	0.2
—	10	9	8	30	28.17	27.91	—	—	2.06	1.9	1.65	1.35	0.4
15	12	—	9	32	30.15	29.9	2.06	1.9	2.06	1.9	1.65	1.35	0.4
17	15	10	—	35	33.17	32.92	2.06	1.9	2.06	1.9	1.65	1.35	0.4
—	—	12	10	37	34.77	34.52	—	—	2.06	1.9	1.65	1.35	0.4
—	17	—	—	40	38.1	37.85	—	—	2.06	1.9	1.65	1.35	0.4
20	—	15	12	42	39.75	39.5	2.06	1.9	2.06	1.9	1.65	1.35	0.4
22	—	—	—	44	41.75	41.5	2.06	1.9	—	—	1.65	1.35	0.4
25	20	17	—	47	44.6	44.35	2.06	1.9	2.46	2.31	1.65	1.35	0.4
—	22	—	—	50	47.6	47.35	—	—	2.46	2.31	1.65	1.35	0.4
28	25	20	15	52	49.73	49.48	2.06	1.9	2.46	2.31	1.65	1.35	0.4
30	—	—	—	55	52.6	52.35	2.08	1.88	—	—	1.65	1.35	0.4
—	—	22	—	56	53.6	53.35	—	—	2.46	2.31	1.65	1.35	0.4
32	28	—	—	58	55.6	55.35	2.08	1.88	2.46	2.31	1.65	1.35	0.4
35	30	25	17	62	59.61	59.11	2.08	1.88	3.28	3.07	2.2	1.9	0.6
—	32	—	—	65	62.6	62.1	—	—	3.28	3.07	2.2	1.9	0.6
40	—	28	—	68	64.82	64.31	2.49	2.29	3.28	3.07	2.2	1.9	0.6
—	35	30	20	72	68.81	68.3	—	—	3.28	3.07	2.2	1.9	0.6
45	—	32	—	75	71.83	71.32	2.49	2.29	3.28	3.07	2.2	1.9	0.6
50	40	35	25	80	76.81	76.3	2.49	2.29	3.28	3.07	2.2	1.9	0.6
—	45	—	—	85	81.81	81.31	—	—	3.28	3.07	2.2	1.9	0.6
55	50	40	30	90	86.79	86.28	2.87	2.67	3.28	3.07	3	2.7	0.6
60	—	—	—	95	91.82	91.31	2.87	2.67	—	—	3	2.7	0.6
65	55	45	35	100	96.8	96.29	2.87	2.67	3.28	3.07	3	2.7	0.6
70	60	50	40	110	106.81	106.3	2.87	2.67	3.28	3.07	3	2.7	0.6
75	—	—	—	115	111.81	111.3	2.87	2.67	—	—	3	2.7	0.6
—	65	55	45	120	115.21	114.71	—	—	4.06	3.86	3.4	3.1	0.6
80	70	—	—	125	120.22	119.71	2.87	2.67	4.06	3.86	3.4	3.1	0.6
85	75	60	50	130	125.22	124.71	2.87	2.67	4.06	3.86	3.4	3.1	0.6
90	80	65	55	140	135.23	134.72	3.71	3.45	4.9	4.65	3.4	3.1	0.6
95	—	—	—	145	140.23	139.73	3.71	3.45	—	—	3.4	3.1	0.6
100	85	70	60	150	145.24	144.73	3.71	3.45	4.9	4.65	3.4	3.1	0.6
105	90	75	65	160	155.22	154.71	3.71	3.45	4.9	4.65	3.4	3.1	0.6
110	95	80	—	170	163.65	163.14	3.71	3.45	5.69	5.44	3.8	3.5	0.6
120	100	85	70	180	173.66	173.15	3.71	3.45	5.69	5.44	3.8	3.5	0.6
—	105	90	75	190	183.64	183.13	—	—	5.69	5.44	3.8	3.5	0.6
130	110	95	80	200	193.65	193.14	5.69	5.44	5.69	5.44	3.8	3.5	0.6

Locating Snap Ring							Side Cover
Locating Snap Ring Number	Cross Sectional Height <i>e</i>		Thickness <i>f</i>		Geometry of snap ring fitted in groove (Reference)		Stepped Bore Diameter (Reference) <i>D</i> _x
	max.	min.	max.	min.	Slit Width <i>g</i> approx.	Snap Ring Outside Diameter <i>D</i> ₂ max.	
NR 26 (1)	2.06	1.91	0.84	0.74	3	28.7	29.4
NR 28 (1)	2.06	1.91	0.84	0.74	3	30.7	31.4
NR 30	3.25	3.1	1.12	1.02	3	34.7	35.5
NR 32	3.25	3.1	1.12	1.02	3	36.7	37.5
NR 35	3.25	3.1	1.12	1.02	3	39.7	40.5
NR 37	3.25	3.1	1.12	1.02	3	41.3	42
NR 40	3.25	3.1	1.12	1.02	3	44.6	45.5
NR 42	3.25	3.1	1.12	1.02	3	46.3	47
NR 44	3.25	3.1	1.12	1.02	3	48.3	49
NR 47	4.04	3.89	1.12	1.02	4	52.7	53.5
NR 50	4.04	3.89	1.12	1.02	4	55.7	56.5
NR 52	4.04	3.89	1.12	1.02	4	57.9	58.5
NR 55	4.04	3.89	1.12	1.02	4	60.7	61.5
NR 56	4.04	3.89	1.12	1.02	4	61.7	62.5
NR 58	4.04	3.89	1.12	1.02	4	63.7	64.5
NR 62	4.04	3.89	1.7	1.6	4	67.7	68.5
NR 65	4.04	3.89	1.7	1.6	4	70.7	71.5
NR 68	4.85	4.7	1.7	1.6	5	74.6	76
NR 72	4.85	4.7	1.7	1.6	5	78.6	80
NR 75	4.85	4.7	1.7	1.6	5	81.6	83
NR 80	4.85	4.7	1.7	1.6	5	86.6	88
NR 85	4.85	4.7	1.7	1.6	5	91.6	93
NR 90	4.85	4.7	2.46	2.36	5	96.5	98
NR 95	4.85	4.7	2.46	2.36	5	101.6	103
NR 100	4.85	4.7	2.46	2.36	5	106.5	108
NR 110	4.85	4.7	2.46	2.36	5	116.6	118
NR 115	4.85	4.7	2.46	2.36	5	121.6	123
NR 120	7.21	7.06	2.82	2.72	7	129.7	131.5
NR 125	7.21	7.06	2.82	2.72	7	134.7	136.5
NR 130	7.21	7.06	2.82	2.72	7	139.7	141.5
NR 140	7.21	7.06	2.82	2.72	7	149.7	152
NR 145	7.21	7.06	2.82	2.72	7	154.7	157
NR 150	7.21	7.06	2.82	2.72	7	159.7	162
NR 160	7.21	7.06	2.82	2.72	7	169.7	172
NR 170	9.6	9.45	3.1	3	10	182.9	185
NR 180	9.6	9.45	3.1	3	10	192.9	195
NR 190	9.6	9.45	3.1	3	10	202.9	205
NR 200	9.6	9.45	3.1	3	10	212.9	215

Note (1) The locating snap rings and snap ring grooves of these bearings are not specified by ISO.
 Remarks 1. The dimensions of these snap ring grooves are not applicable to bearings of dimension series 00, 82, and 83.
 2. The minimum permissible chamfer dimension *r*_N on the snap-ring side of outer rings is 0.5mm. However, for bearings of diameter series 0 having outside diameters 35mm and below, it is 0.3mm.

7.2 Formulation of Bearing Numbers

Bearing numbers are alphanumeric combinations that indicate the bearing type, boundary dimensions, dimensional and running accuracies, internal clearance, and other related specifications. They consist of basic numbers and supplementary symbols. The boundary dimensions of commonly used bearings mostly conform to the organizational concept of ISO, and the bearing numbers of these standard bearings are specified by JIS B 1513 (Bearing Numbers for Rolling Bearings). Due to a need for more detailed classification, NSK uses auxiliary symbols other than those specified by JIS.

Bearing numbers consist of a basic number and supplementary symbols. The basic number indicates the bearing series(type) and the width and diameter series as shown in Table 7.5. Basic numbers, supplementary symbols, and the meanings of common numbers and symbols are listed in Table 7.6 (Pages A56 and A57). The contact angle symbols and other supplementary designations are shown in successive columns from left to right in Table 7.6. For reference, some examples of bearing designations are shown here:

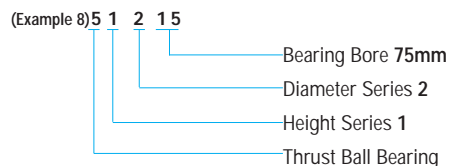
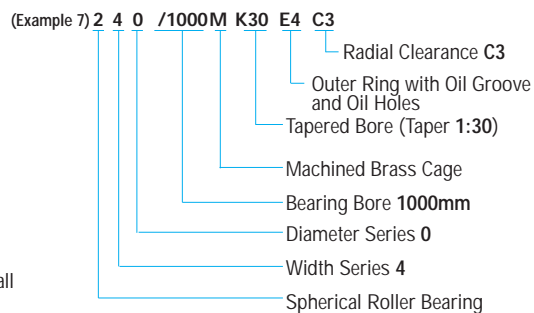
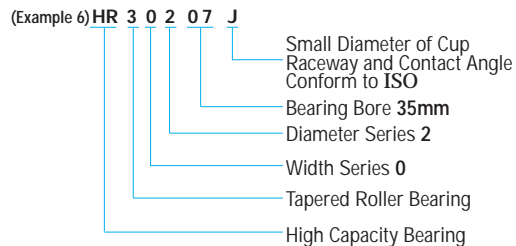
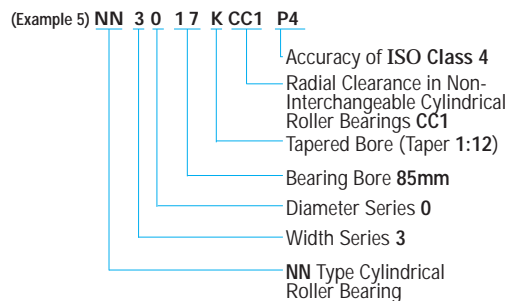
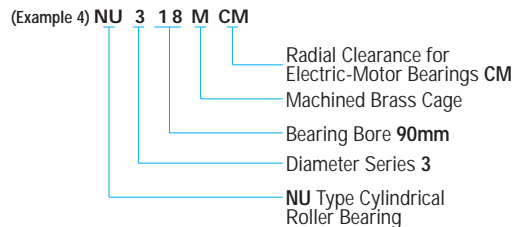
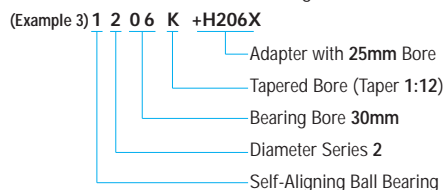
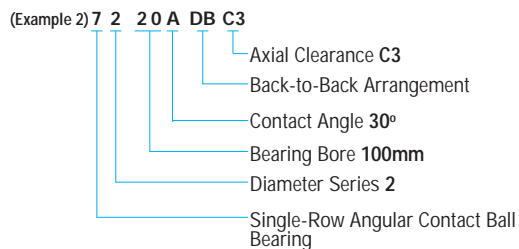
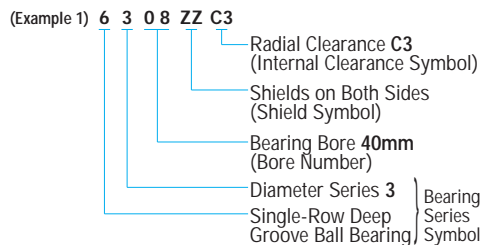

Table 7.5 Bearing Series Symbols

Bearing Type	Bearing Series Symbols	Type Symbols	Dimension Symbols	
			Width Symbols	Diameter Symbols
Single-Row Deep Groove Ball Bearings	68	6	(1)	8
	69	6	(1)	9
	60	6	(1)	0
	62	6	(0)	2
Single-Row Angular Contact Ball Bearings	63	6	(0)	3
	79	7	(1)	9
	70	7	(1)	0
	72	7	(0)	2
Self-Aligning Ball Bearings	73	7	(0)	3
	12	1	(0)	2
	13	1	(0)	3
	22	(1)	2	2
Single-Row Cylindrical Roller Bearings	23	(1)	2	3
	NU10	NU	1	0
	NU2	NU	(0)	2
	NU22	NU	2	2
Single-Row Cylindrical Roller Bearings	NU3	NU	(0)	3
	NU23	NU	2	3
	NU4	NU	(0)	4
	Single-Row Cylindrical Roller Bearings	NJ2	NJ	(0)
NJ22		NJ	2	2
NJ3		NJ	(0)	3
NJ23		NJ	2	3
Single-Row Cylindrical Roller Bearings	NJ4	NJ	(0)	4
	NUP2	NUP	(0)	2
	NUP22	NUP	2	2
	NUP3	NUP	(0)	3
Single-Row Cylindrical Roller Bearings	NUP23	NUP	2	3
	NUP4	NUP	(0)	4
	N10	N	1	0
	N2	N	(0)	2
Single-Row Cylindrical Roller Bearings	N3	N	(0)	3
	N4	N	(0)	4
	NF2	NF	(0)	2
	NF3	NF	(0)	3
Single-Row Cylindrical Roller Bearings	NF4	NF	(0)	4
	230	2	3	0
	231	2	3	1
	222	2	2	2
Tapered Roller Bearings	232	3	0	2
	322	3	2	2
	332	3	3	2
	303	3	0	3
Tapered Roller Bearings	323	3	2	3
	230	2	3	0
	231	2	3	1
	222	2	2	2
Spherical Roller Bearings	232	2	3	2
	213 (1)	2	0	3
	223	2	2	3
	Spherical Roller Bearings	511	5	1
512		5	1	2
513		5	1	3
514		5	1	4
Thrust Ball Bearings with Flat Seats	522	5	2	2
	523	5	2	3
	524	5	2	4
	Spherical Thrust Roller Bearings	292	2	9
293		2	9	3
294		2	9	4

Note (1) Bearing Series Symbol 213 should logically be 203, but customarily it is numbered 213.
Remarks Numbers in () in the column of width symbols are usually omitted from the bearing number.

Table 7. 6 Formulation of

Basic Numbers														
Bearing Series Symbols (1)		Bore Number		Contact Angle Symbol		Internal Design Symbol		Material Symbol		Cage Symbol		External Features		
Symbol	Meaning	Symbol	Meaning	Symbol	Meaning	Symbol	Meaning	Symbol	Meaning	Symbol	Meaning	Symbol	Meaning	
68	Single-Row Deep Groove Ball Bearings	1	Bearing Bore 1mm	A	Angular Contact Ball Bearings	A	Internal Design Differs from Standard One	g	Case-Hardened Steel Used in Rings, Rolling Elements	M	Machined Brass Cage	Z	Shield on One Side Only	
69	Single-Row Angular Contact Ball Bearings	2	2			J	Smaller Diameter of Outer Ring Raceway, Contact Angle, and Outer Ring Width of Tapered Roller Bearings Conform to ISO 355					ZS	Shields on Both Sides	
70	Single-Row Angular Contact Ball Bearings	3	3			A5	Standard Contact Angle of 25°					ZZ	Shields on Both Sides	
72	Self-Aligning Ball Bearings	9	9	B	Standard Contact Angle of 40°	J	Standard Contact Angle of 30°	h	Stainless Steel Used in Rings, Rolling Elements	W	Pressed Steel Cage	ZZS	Shields on Both Sides	
73	Self-Aligning Ball Bearings	00	10									DU	Contact Rubber Seal on One Side Only	
12	Self-Aligning Ball Bearings	01	12									DDU	Contact Rubber Seals on Both Sides	
13	Cylindrical Roller Bearings	02	15	C	Standard Contact Angle of 15°	(For High Capacity Bearings)	C	V	Without Cage	T	Synthetic Resin Cage	VV	Non-Contact Rubber Seals on Both Sides	
22	Cylindrical Roller Bearings	03	17									CA	Spherical Roller Bearings	
NU10	Cylindrical Roller Bearings	/22	22									CD		
NJ 2	Cylindrical Roller Bearings	/28	28	Omitted	Contact Angle Less than 17°	EA	E	Cylindrical Roller Bearings	E	Spherical Thrust Roller Bearings	V	Non-Contact Rubber Seal on One Side Only		
N 3	Cylindrical Roller Bearings	/32	32										EA	
NN 30	Cylindrical Roller Bearings	/32	32										EA	
NA48	Needle Roller Bearings	04(2)	20	C	Contact Angle about 20°	E	Cylindrical Roller Bearings	E	Spherical Thrust Roller Bearings	E	Spherical Thrust Roller Bearings	V	Non-Contact Rubber Seals on Both Sides	
NA49	Needle Roller Bearings	05	25											EA
NA69	Needle Roller Bearings	06	30											EA
320	Tapered Roller Bearings	08	440	D	Contact Angle about 28°	E	Spherical Thrust Roller Bearings	E	Spherical Thrust Roller Bearings	E	Spherical Thrust Roller Bearings	V	Non-Contact Rubber Seals on Both Sides	
322	Tapered Roller Bearings	92	460											EA
323	Tapered Roller Bearings	96	480											EA
511	Thrust Ball Bearing with Flat Seats	/530	530	D	Contact Angle about 28°	E	Spherical Thrust Roller Bearings	E	Spherical Thrust Roller Bearings	E	Spherical Thrust Roller Bearings	V	Non-Contact Rubber Seals on Both Sides	
512	Thrust Ball Bearing with Flat Seats	/560	560											EA
513	Thrust Ball Bearing with Flat Seats	/500	500											EA
292	Thrust Spherical Roller Bearings	/2 360	2 360	D	Contact Angle about 28°	E	Spherical Thrust Roller Bearings	E	Spherical Thrust Roller Bearings	E	Spherical Thrust Roller Bearings	V	Non-Contact Rubber Seals on Both Sides	
293	Thrust Spherical Roller Bearings	/2 500	2 500											EA
294	Thrust Spherical Roller Bearings	/2 500	2 500											EA
HR(4)	High Capacity Tapered Roller Bearings, and others													
Symbols and Numbers Conform to JIS(5)						NSK Symbol						NSK Symbol		
Marked on Bearings										Not Marked on Bearings				

- Notes (1) Bearing Series Symbols conform to Table 7.5.
 (2) For basic numbers of tapered roller bearings in ISO's new series, refer to Page B111.
 (3) For Bearing Bore Numbers 04 through 96, five times the bore number gives the bore size (mm) (except double-direction thrust ball bearings).
 (4) HR is prefix to bearing series symbols and it is NSK's original prefix.

Bearing Numbers

Auxiliary Symbols													
Symbol		Arrangement Symbol		Internal Clearance Symbol		Tolerance Class Symbol		Special Specification Symbol		Spacer or Sleeve Symbol		Grease Symbol	
Symbol for Design of Rings	Symbol for Design of Rings	Symbol for Design of Rings	Symbol for Design of Rings	Symbol for Design of Rings	Symbol for Design of Rings	Symbol for Design of Rings	Symbol for Design of Rings	Symbol for Design of Rings	Symbol for Design of Rings	Symbol for Design of Rings	Symbol for Design of Rings	Symbol for Design of Rings	Symbol for Design of Rings
Symbol	Meaning	Symbol	Meaning	Symbol	Meaning (radial clearance)	Symbol	Meaning	Symbol	Meaning	Symbol	Meaning	Symbol	Meaning
K	Tapered Bore of Inner Ring (Taper 1:12)	DB	Back-to-Back Arrangement	C1	Clearance Less than C2	Omitted	ISO Normal	(Bearings treated for Dimensional Stabilization)	+K	Bearings with Outer Ring Spacers	AS2	SHELL ALVANIA GREASE S2	
				C2	Clearance Less than CN								
K30	Tapered Bore of Inner Ring (Taper 1:30)	DF	Face-to-Face Arrangement	Omitted	CN Clearance	P6	ISO Class 6	X26	Working Temperature Lower than 150 °C	+L	Bearings with Inner Ring Spacers	ENS	ENS GREASE
				C3	Clearance Greater than CN								
E	Notch or Lubricating Groove in Ring	DT	Tandem Arrangement	C4	Clearance Greater than C3	P6X	ISO Class 6X	X28	Working Temperature Lower than 200 °C	+KL	Bearings with Both Inner and Outer Ring Spacers	NS7	NS HI-LUBE
				C5	Clearance Greater than C4								
E4	Lubricating Groove in Outside Surface and Holes in Outer Ring	CC	Normal Clearance	CC1	Clearance Less than CC2	P5	ISO Class 5	X29	Working Temperature Lower than 250 °C	H	Adapter Designation	PS2	MULTEMP PS No. 2
				CC2	Clearance Less than CC								
N	Snap Ring Groove in Outer Ring	CC	Normal Clearance	CC3	Clearance Greater than CC	P4	ISO Class 4	(ABMA(7) Tapered roller bearing)	(Spherical Roller Bearings)	AH	Withdrawal Sleeve Designation	HJ	Thrust Collar Designation
				CC4	Clearance Greater than CC3								
NR	Snap Ring Groove with Snap Ring in Outer Ring	MC	Clearance in Deep Groove Ball Bearings for Electric Motors	MC1	Clearance Less than MC2	Omitted	Class 4	S11	Dimensional Stabilizing Treatment Working Temperature Lower than 200°C	H	Adapter Designation	PS2	MULTEMP PS No. 2
				MC2	Clearance Less than MC3								
NR	Snap Ring Groove with Snap Ring in Outer Ring	MC	Clearance in Deep Groove Ball Bearings for Electric Motors	MC3	Normal Clearance	PN2	Class 2	S11	Dimensional Stabilizing Treatment Working Temperature Lower than 200°C	H	Adapter Designation	PS2	MULTEMP PS No. 2
				MC4	Clearance Greater than MC3								
NR	Snap Ring Groove with Snap Ring in Outer Ring	MC	Clearance in Deep Groove Ball Bearings for Electric Motors	MC5	Clearance Greater than MC4	PN3	Class 3	S11	Dimensional Stabilizing Treatment Working Temperature Lower than 200°C	H	Adapter Designation	PS2	MULTEMP PS No. 2
				MC6	Clearance Greater than MC5								
NR	Snap Ring Groove with Snap Ring in Outer Ring	CM	Clearance in Cylindrical Roller Bearings for Electric Motors	CM	Clearance in Deep Groove Ball Bearings for Electric Motors	PN0	Class 0	S11	Dimensional Stabilizing Treatment Working Temperature Lower than 200°C	H	Adapter Designation	PS2	MULTEMP PS No. 2
				CT	Clearance in Cylindrical Roller Bearings for Electric Motors								
NR	Snap Ring Groove with Snap Ring in Outer Ring	CM	Clearance in Cylindrical Roller Bearings for Electric Motors	(Preload of Angular Contact Ball Bearing)		PN00	Class 00	S11	Dimensional Stabilizing Treatment Working Temperature Lower than 200°C	H	Adapter Designation	PS2	MULTEMP PS No. 2
				EL	Extra light Preload								
NR	Snap Ring Groove with Snap Ring in Outer Ring	CM	Clearance in Cylindrical Roller Bearings for Electric Motors	L	Light Preload	PN00	Class 00	S11	Dimensional Stabilizing Treatment Working Temperature Lower than 200°C	H	Adapter Designation	PS2	MULTEMP PS No. 2
				M	Medium Preload								
NR	Snap Ring Groove with Snap Ring in Outer Ring	CM	Clearance in Cylindrical Roller Bearings for Electric Motors	H	Heavy Preload	PN00	Class 00	S11	Dimensional Stabilizing Treatment Working Temperature Lower than 200°C	H	Adapter Designation	PS2	MULTEMP PS No. 2
Partially the same as JIS(5)	Same as JIS(5)	NSK Symbol	Partially the same as JIS(5)/BAS(6)	Same as JIS(5)	NSK Symbol, Partially the same as JIS(5)	In Principle, Marked on Bearings		Not Marked on Bearings					

- Notes (5) JIS : Japanese Industrial Standards.
 (6) BAS : The Japan Bearing Industrial Association Standard.
 (7) ABMA : The American Bearing Manufacturers Association.

8. BEARING TOLERANCES

8.1 Bearing Tolerance Standards

The tolerances for the boundary dimensions and running accuracy of rolling bearings are specified by ISO 492/199/582 (Accuracies of Rolling Bearings). Tolerances are specified for the following items:

Regarding bearing accuracy classes, besides ISO normal accuracy, as the accuracy improves there are **Class 6X** (for tapered roller bearings), **Class 6**, **Class 5**, **Class 4**, and **Class 2**, with **Class 2** being the highest in ISO. The applicable accuracy classes for each bearing type and the correspondence of these classes are shown in Table 8.1.

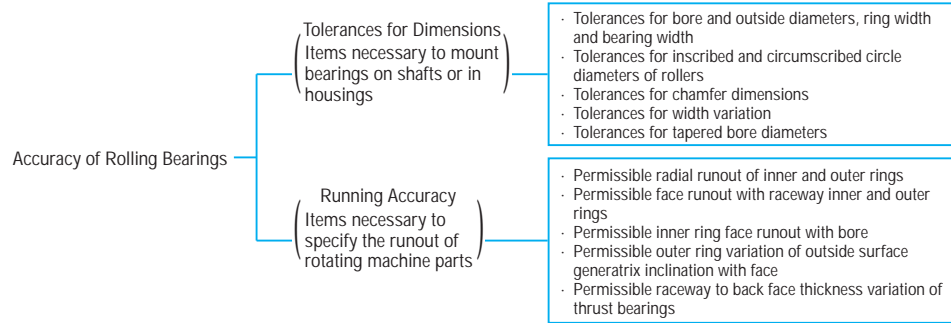

Table 8.1 Bearing Types and Tolerance Classes

Bearing Types		Applicable Tolerance Classes					Applicable Tables	Reference Pages
Deep Groove Ball Bearings	Normal	Class 6	Class 5	Class 4	Class 2	Table 8.2	A60 to A63	
Angular Contact Ball Bearings	Normal	Class 6	Class 5	Class 4	Class 2			
Self-Aligning Ball Bearings	Normal	Class 6 equivalent	Class 5 equivalent	—	—			
Cylindrical Roller Bearings	Normal	Class 6	Class 5	Class 4	Class 2			
Needle Roller Bearings (solid type)	Normal	Class 6	Class 5	Class 4	—			
Spherical Roller Bearings	Normal	Class 6	Class 5	—	—	Table 8.3	A64 to A67	
Tapered Roller Bearings	Metric Design	Normal Class 6X	—	Class 5	Class 4			—
	Inch Design	ANSI/ABMA CLASS 4	ANSI/ABMA CLASS 2	ANSI/ABMA CLASS 3	ANSI/ABMA CLASS 0	ANSI/ABMA CLASS 00	Table 8.4	A68 and A69
Magneto Bearings	Normal	Class 6	Class 5	—	—	Table 8.5	A70 and A71	
Thrust Ball Bearings	Normal	Class 6	Class 5	Class 4	—	Table 8.4	A72 to A74	
Thrust Spherical Roller Bearings	Normal	—	—	—	—	Table 8.7	A75	
Equivalent standards (Reference)	JIS ⁽¹⁾	Class 0	Class 6	Class 5	Class 4	Class 2	—	—
	DIN ⁽²⁾	P0	P6	P5	P4	P2	—	—
	ANSI/ABMA ⁽³⁾	Ball Bearings	ABEC 1	ABEC 3	ABEC 5 (CLASS 5P)	ABEC 7 (CLASS 7P)	ABEC 9 (CLASS 9P)	Table 8.2 [Table 8.8]
Roller Bearings		RBEC 1	RBEC 3	RBEC 5	—	—	Table 8.4	(A68 and A69)
Tapered Roller Bearings		CLASS 4	CLASS 2	CLASS 3	CLASS 0	CLASS 00	Table 8.4	(A68 and A69)

Notes (1) JIS : Japanese Industrial Standards (2) DIN : Deutsch Industrie Norm

(3) ANSI/ABMA : The American Bearing Manufacturers Association

Remarks The permissible limit of chamfer dimensions shall conform to Table 8.9 (Page A78), and the tolerances and permissible tapered bore diameters shall conform to Table 8.10 (Page A80).

(Reference) Rough definitions of the items listed for Running Accuracy and their measuring methods are shown in Fig. 8.1, and they are described in detail in ISO 5593 (Rolling Bearings-Vocabulary) and JIS B 1515 (Rolling Bearings-Tolerances) and elsewhere.

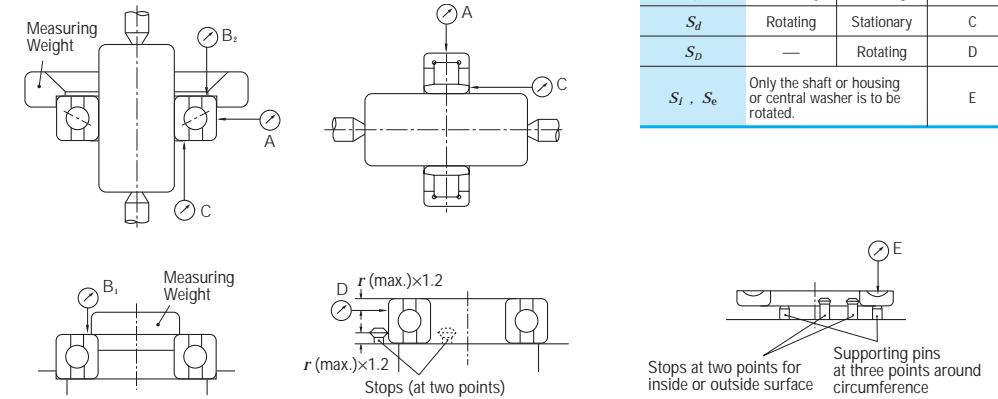

Fig. 8.1 Measuring Methods for Running Accuracy (summarized)

Supplementary Table

Running Accuracy	Inner Ring	Outer Ring	Dial Gauge
K_{ia}	Rotating	Stationary	A
K_{ea}	Stationary	Rotating	A
S_{ia}	Rotating	Stationary	B ₁
S_{ea}	Stationary	Rotating	B ₂
S_d	Rotating	Stationary	C
S_D	—	Rotating	D
S_i, S_e	Only the shaft or housing or central washer is to be rotated.		E

Symbols for Boundary Dimensions and Running Accuracy

d	Brg bore dia., nominal	D	Brg outside dia., nominal
Δ_{ds}	Deviation of a single bore dia.	Δ_{Ds}	Deviation of a single outside dia.
Δ_{dmp}	Single plane mean bore dia. deviation	Δ_{Dmp}	Single plane mean outside dia. Deviation
V_{dp}	Bore dia. Variation in a single radial plane	V_{Dp}	Outside dia. Variation in a single radial plane
V_{dmp}	Mean bore dia. Variation	V_{Dmp}	Mean outside dia. Variation
B	Inner ring width, nominal	C	Outer ring width, nominal
Δ_{Bs}	Deviation of a single inner ring width	Δ_{Cs}	Deviation of a single outer ring width
V_{Bs}	Inner ring width variation	V_{Cs}	Outer ring width variation
K_{ia}	Radial runout of assembled brg inner ring inner ring reference face (backface, where applicable) runout with bore	K_{ea}	Radial runout of assembled brg outer ring Variation of brg outside surface generatrix inclination with outer ring reference face (backface)
S_{ia}	Assembled brg inner ring face (back face) runout with raceway	S_D	Variation of brg outside surface generatrix inclination with outer ring reference face (backface)
S_i, S_e	Raceway to backface thickness variation of thrust brg	S_{ea}	Assembled brg outer ring face (backface) runout with raceway
T	Brg width, nominal		
Δ_{Ts}	Deviation of the actual brg width		

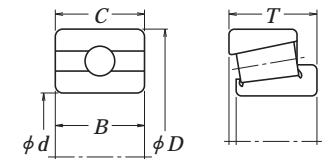

Table 8. 2 Tolerances for Radial Bearings

Table 8. 2. 1 Tolerances for Inner Rings and

Nominal Bore Diameter <i>d</i> (mm)		$\Delta_{dmp} (\text{°})$										$\Delta_{ds} (\text{°})$				
		Normal		Class 6		Class 5		Class 4		Class 2		Class 4		Class 2		
												Diameter Series				
												0, 1, 2, 3, 4				
over	incl.	high	low	high	low	high	low	high	low	high	low	high	low	high	low	
0.6 ⁽¹⁾	2.5	0	-8	0	-7	0	-5	0	-4	0	-2.5	0	-4	0	-2.5	
2.5	10	0	-8	0	-7	0	-5	0	-4	0	-2.5	0	-4	0	-2.5	
10	18	0	-8	0	-7	0	-5	0	-4	0	-2.5	0	-4	0	-2.5	
18	30	0	-10	0	-8	0	-6	0	-5	0	-2.5	0	-5	0	-2.5	
30	50	0	-12	0	-10	0	-8	0	-6	0	-2.5	0	-6	0	-2.5	
50	80	0	-15	0	-12	0	-9	0	-7	0	-4	0	-7	0	-4	
80	120	0	-20	0	-15	0	-10	0	-8	0	-5	0	-8	0	-5	
120	150	0	-25	0	-18	0	-13	0	-10	0	-7	0	-10	0	-7	
150	180	0	-25	0	-18	0	-13	0	-10	0	-7	0	-10	0	-7	
180	250	0	-30	0	-22	0	-15	0	-12	0	-8	0	-12	0	-8	
250	315	0	-35	0	-25	0	-18	-	-	-	-	-	-	-	-	
315	400	0	-40	0	-30	0	-23	-	-	-	-	-	-	-	-	
400	500	0	-45	0	-35	-	-	-	-	-	-	-	-	-	-	
500	630	0	-50	0	-40	-	-	-	-	-	-	-	-	-	-	
630	800	0	-75	-	-	-	-	-	-	-	-	-	-	-	-	
800	1 000	0	-100	-	-	-	-	-	-	-	-	-	-	-	-	
1 000	1 250	0	-125	-	-	-	-	-	-	-	-	-	-	-	-	
1 250	1 600	0	-160	-	-	-	-	-	-	-	-	-	-	-	-	
1 600	2 000	0	-200	-	-	-	-	-	-	-	-	-	-	-	-	

(excluding Tapered Roller Bearings)

Widths of Outer Rings

$V_{dp} (\text{°})$															$V_{dmp} (\text{°})$				
Normal			Class 6			Class 5			Class 4			Class 2			Normal	Class 6	Class 5	Class 4	Class 2
Diameter Series			Diameter Series			Diameter Series			Diameter Series			Diameter Series							
9	0, 1	2, 3, 4	9	0, 1	2, 3, 4	9	0,1,2,3,4	9	0,1,2,3,4	0,1,2,3,4	9	0,1,2,3,4	0,1,2,3,4						
max.			max.			max.			max.			max.							
10	8	6	9	7	5	5	4	4	3	2.5	6	5	3	2	1.5				
10	8	6	9	7	5	5	4	4	3	2.5	6	5	3	2	1.5				
10	8	6	9	7	5	5	4	4	3	2.5	6	5	3	2	1.5				
13	10	8	10	8	6	6	5	5	4	2.5	8	6	3	2.5	1.5				
15	12	9	13	10	8	8	6	6	5	2.5	9	8	4	3	1.5				
19	19	11	15	15	9	9	7	7	5	4	11	9	5	3.5	2				
25	25	15	19	19	11	10	8	8	6	5	15	11	5	4	2.5				
31	31	19	23	23	14	13	10	10	8	7	19	14	7	5	3.5				
31	31	19	23	23	14	13	10	10	8	7	19	14	7	5	3.5				
38	38	23	28	28	17	15	12	12	9	8	23	17	8	6	4				
44	44	26	31	31	19	18	14	-	-	-	26	19	9	-	-				
50	50	30	38	38	23	23	18	-	-	-	30	23	12	-	-				
56	56	34	44	44	26	-	-	-	-	-	34	26	-	-	-				
63	63	38	50	50	30	-	-	-	-	-	38	30	-	-	-				
-	-	-	-	-	-	-	-	-	-	-	-	-	-	-	-				
-	-	-	-	-	-	-	-	-	-	-	-	-	-	-	-				
-	-	-	-	-	-	-	-	-	-	-	-	-	-	-	-				
-	-	-	-	-	-	-	-	-	-	-	-	-	-	-	-				
-	-	-	-	-	-	-	-	-	-	-	-	-	-	-	-				
-	-	-	-	-	-	-	-	-	-	-	-	-	-	-	-				

Units : μm

$\Delta_{Bs} \text{ (or } \Delta_{Cs}) (\text{°})$											$V_{Bs} \text{ (or } V_{Cs})$					
Single Bearing						Combined Bearings ⁽⁴⁾					Inner Ring (or Outer Ring) ⁽⁵⁾		Inner Ring			
Normal Class 6		Class 5 Class 4		Class 2		Normal Class 6		Class 5 Class 4		Class 2		Normal	Class 6	Class 5	Class 4	Class 2
high	low	high	low	high	low	high	low	high	low	high	low	max.	max.	max.	max.	max.
0	-40	0	-40	0	-40	-	-	0	-250	0	-250	12	12	5	2.5	1.5
0	-120	0	-40	0	-40	0	-250	0	-250	0	-250	15	15	5	2.5	1.5
0	-120	0	-80	0	-80	0	-250	0	-250	0	-250	20	20	5	2.5	1.5
0	-120	0	-120	0	-120	0	-250	0	-250	0	-250	20	20	5	2.5	1.5
0	-120	0	-120	0	-120	0	-250	0	-250	0	-250	20	20	5	3	1.5
0	-150	0	-150	0	-150	0	-380	0	-250	0	-250	25	25	6	4	1.5
0	-200	0	-200	0	-200	0	-380	0	-380	0	-380	25	25	7	4	2.5
0	-250	0	-250	0	-250	0	-500	0	-380	0	-380	30	30	8	5	2.5
0	-250	0	-250	0	-250	0	-500	0	-380	0	-380	30	30	8	5	4
0	-300	0	-300	0	-300	0	-500	0	-500	0	-500	30	30	10	6	5
0	-350	0	-350	-	-	0	-500	0	-500	-	-	35	35	13	-	-
0	-400	0	-400	-	-	0	-630	0	-630	-	-	40	40	15	-	-
0	-450	-	-	-	-	-	-	-	-	-	-	50	45	-	-	-
0	-500	-	-	-	-	-	-	-	-	-	-	60	50	-	-	-
0	-750	-	-	-	-	-	-	-	-	-	-	70	-	-	-	-
0	-1 000	-	-	-	-	-	-	-	-	-	-	80	-	-	-	-
0	-1 250	-	-	-	-	-	-	-	-	-	-	100	-	-	-	-
0	-1 600	-	-	-	-	-	-	-	-	-	-	120	-	-	-	-
0	-2 000	-	-	-	-	-	-	-	-	-	-	140	-	-	-	-

- Notes (1) 0.6mm is included in the group.
 (2) Applicable to bearings with cylindrical bores.
 (3) Tolerance for width deviation and tolerance limits for the width variation of the outer ring should be the same bearing. Tolerances for the width variation of the outer ring of Class 5, 4, and 2 are shown in Table 8.2.2.
 (4) Applicable to individual rings manufactured for combined bearings.
 (5) Applicable to ball bearings such as deep groove ball bearings, angular contact ball bearings, etc.

K_{ia}					S_d			$S_{ia} (\text{°})$			Nominal Bore Diameter <i>d</i> (mm)	
Normal	Class 6	Class 5	Class 4	Class 2	Class 5	Class 4	Class 2	Class 5	Class 4	Class 2		
max.	max.	max.	max.	max.	max.	max.	max.	max.	max.	max.		
over	incl.	over	incl.	over	incl.	over	incl.	over	incl.	over		
10	5	4	2.5	1.5	7	3	1.5	7	3	1.5	0.6 ⁽¹⁾	2.5
10	6	4	2.5	1.5	7	3	1.5	7	3	1.5	2.5	10
10	7	4	2.5	1.5	7	3	1.5	7	3	1.5	10	18
13	8	4	3	2.5	8	4	1.5	8	4	2.5	18	30
15	10	5	4	2.5	8	4	1.5	8	4	2.5	30	50
20	10	5	4	2.5	8	5	1.5	8	5	2.5	50	80
25	13	6	5	2.5	9	5	2.5	9	5	2.5	80	120
30	18	8	6	2.5	10	6	2.5	10	7	2.5	120	150
30	18	8	6	5	10	6	4	10	7	5	150	180
40	20	10	8	5	11	7	5	13	8	5	180	250
50	25	13	-	-	13	-	-	15	-	-	250	315
60	30	15	-	-	15	-	-	20	-	-	315	400
65	35	-	-	-	-	-	-	-	-	-	400	500
70	40	-	-	-	-	-	-	-	-	-	500	630
80	-	-	-	-	-	-	-	-	-	-	630	800
90	-	-	-	-	-	-	-	-	-	-	800	1 000
100	-	-	-	-	-	-	-	-	-	-	1 000	1 250
120	-	-	-	-	-	-	-	-	-	-	1 250	1 600
140	-	-	-	-	-	-	-	-	-	-	1 600	2 000

- Remarks 1. The cylindrical bore diameter "no-go side" tolerance limit (high) specified in this table does not necessarily apply within a distance of 1.2 times the chamfer dimension *r* (max.) from the ring face.
 2. ABMA Std 20-1996: ABEC1-RBEC1, ABEC3-RBEC3, ABEC5-RBEC5, ABEC7-RBEC7, and ABEC9-RBEC9 are equivalent to Classes Normal, 6, 5, 4, and 2 respectively.

Table 8. 2 Tolerances for Radial Bearings

Table 8. 2. 2 Tolerances

Nominal Outside Diameter <i>D</i> (mm)		Δ_{Dmp}										Δ_{Ds}			
		Normal		Class 6		Class 5		Class 4		Class 2		Class 4		Class 2	
												Diameter Series			
		over	incl.	high	low	high	low	high	low	high	low	high	low	high	low
2.5 ⁽¹⁾	6	0	- 8	0	- 7	0	- 5	0	- 4	0	- 2.5	0	- 4	0	- 2.5
6	18	0	- 8	0	- 7	0	- 5	0	- 4	0	- 2.5	0	- 4	0	- 2.5
18	30	0	- 9	0	- 8	0	- 6	0	- 5	0	- 4	0	- 5	0	- 4
30	50	0	- 11	0	- 9	0	- 7	0	- 6	0	- 4	0	- 6	0	- 4
50	80	0	- 13	0	- 11	0	- 9	0	- 7	0	- 4	0	- 7	0	- 4
80	120	0	- 15	0	- 13	0	- 10	0	- 8	0	- 5	0	- 8	0	- 5
120	150	0	- 18	0	- 15	0	- 11	0	- 9	0	- 5	0	- 9	0	- 5
150	180	0	- 25	0	- 18	0	- 13	0	- 10	0	- 7	0	- 10	0	- 7
180	250	0	- 30	0	- 20	0	- 15	0	- 11	0	- 8	0	- 11	0	- 8
250	315	0	- 35	0	- 25	0	- 18	0	- 13	0	- 8	0	- 13	0	- 8
315	400	0	- 40	0	- 28	0	- 20	0	- 15	0	- 10	0	- 15	0	- 10
400	500	0	- 45	0	- 33	0	- 23	-	-	-	-	-	-	-	-
500	630	0	- 50	0	- 38	0	- 28	-	-	-	-	-	-	-	-
630	800	0	- 75	0	- 45	0	- 35	-	-	-	-	-	-	-	-
800	1 000	0	- 100	0	- 60	-	-	-	-	-	-	-	-	-	-
1 000	1 250	0	- 125	-	-	-	-	-	-	-	-	-	-	-	-
1 250	1 600	0	- 160	-	-	-	-	-	-	-	-	-	-	-	-
1 600	2 000	0	- 200	-	-	-	-	-	-	-	-	-	-	-	-
2 000	2 500	0	- 250	-	-	-	-	-	-	-	-	-	-	-	-

- Notes (1) 2.5mm is included in the group.
 (2) Applicable only when a locating snap ring is not used.
 (3) Applicable to ball bearings such as deep groove ball bearings and angular contact ball bearings.
 (4) The tolerances for outer ring width variation of bearings of **Classes Normal** and **6** are shown in Table 8.2.1.
- Remarks 1. The outside diameter "no-go side" tolerances (low) specified in this table do not necessarily apply within a distance of 1.2 times the chamfer dimension *r* (max.) from the ring face.
 2. ABMA Std 20-1996: ABEC1-RBEC1, ABEC3-RBEC3, ABEC5-RBEC5, ABEC7-RBEC7, and ABEC9- RBEC9 are equivalent to Classes Normal, 6, 5, 4, and 2 respectively.

(excluding Tapered Roller Bearings)

for Outer Rings

V_{Dp} (°)														V_{Dmp} (°)				
Normal				Class 6				Class 5		Class 4		Class 2		Normal	Class 6	Class 5	Class 4	Class 2
Open Type		Shielded Sealed	Open Type		Shielded Sealed	Open Type		Open Type		Open Type								
Diameter Series				Diameter Series				Diameter Series		Diameter Series		Diameter Series						
9	0, 1	2, 3, 4	2, 3, 4	9	0, 1	2, 3, 4	0,1,2,3,4	9	0,1,2,3,4	9	0,1,2,3,4	0,1,2,3,4						
max.				max.				max.		max.		max.		max.	max.	max.	max.	max.
10	8	6	10	9	7	5	9	5	4	4	3	2.5	6	5	3	2	1.5	
10	8	6	10	9	7	5	9	5	4	4	3	2.5	6	5	3	2	1.5	
12	9	7	12	10	8	6	10	6	5	5	4	4	7	6	3	2.5	2	
14	11	8	16	11	9	7	13	7	5	6	5	4	8	7	4	3	2	
16	13	10	20	14	11	8	16	9	7	7	5	4	10	8	5	3.5	2	
19	19	11	26	16	10	20	20	10	8	8	6	5	11	10	5	4	2.5	
23	23	14	30	19	11	25	11	8	9	7	5	14	11	6	5	2.5		
31	31	19	38	23	23	14	30	13	10	10	8	7	19	14	7	5	3.5	
38	38	23	-	25	25	15	-	15	11	11	8	8	23	15	8	6	4	
44	44	26	-	31	31	19	-	18	14	13	10	8	26	19	9	7	4	
50	50	30	-	35	35	21	-	20	15	15	11	10	30	21	10	8	5	
56	56	34	-	41	41	25	-	23	17	-	-	-	34	25	12	-	-	
63	63	38	-	48	48	29	-	28	21	-	-	-	38	29	14	-	-	
94	94	55	-	56	56	34	-	35	26	-	-	-	55	34	18	-	-	
125	125	75	-	75	75	45	-	-	-	-	-	-	75	45	-	-	-	
-	-	-	-	-	-	-	-	-	-	-	-	-	-	-	-	-	-	
-	-	-	-	-	-	-	-	-	-	-	-	-	-	-	-	-	-	
-	-	-	-	-	-	-	-	-	-	-	-	-	-	-	-	-	-	
-	-	-	-	-	-	-	-	-	-	-	-	-	-	-	-	-	-	

Units : μm

K_{ea}													S_D			S_{ea} (°)			V_{Cs} (°)			Nominal Outside Diameter <i>D</i> (mm)	
Normal	Class 6	Class 5	Class 4	Class 2	Class 5	Class 4	Class 2	Class 5	Class 4	Class 2	Class 5	Class 4	Class 2	Class 5	Class 4	Class 2							
max.	max.	max.	max.	max.	max.	max.	max.	max.	max.	max.	max.	max.	max.	max.	max.	max.							
15	8	5	3	1.5	8	4	1.5	8	5	1.5	5	2.5	1.5	2.5	1.5	2.5 (1)	6						
15	8	5	3	1.5	8	4	1.5	8	5	1.5	5	2.5	1.5	2.5	1.5	2.5	6						
15	9	6	4	2.5	8	4	1.5	8	5	2.5	5	2.5	1.5	2.5	1.5	2.5	18						
20	10	7	5	2.5	8	4	1.5	8	5	2.5	5	2.5	1.5	2.5	1.5	2.5	30						
25	13	8	5	4	8	4	1.5	10	5	4	6	3	1.5	5	4	3	50						
35	18	10	6	5	9	5	2.5	11	6	5	8	4	2.5	8	4	2.5	80						
40	20	11	7	5	10	5	2.5	13	7	5	8	5	2.5	10	7	4	120						
45	23	13	8	5	10	5	2.5	14	8	5	8	5	2.5	11	7	4	150						
50	25	15	10	7	11	7	4	15	10	7	10	7	4	12	7	4	180						
60	30	18	11	7	13	8	5	18	10	7	11	7	5	15	7	5	250						
70	35	20	13	8	13	10	7	20	13	8	13	8	7	18	8	7	315						
80	40	23	-	-	15	-	-	23	-	-	15	-	-	20	-	-	400						
100	50	25	-	-	18	-	-	25	-	-	18	-	-	25	-	-	500						
120	60	30	-	-	20	-	-	30	-	-	20	-	-	30	-	-	630						
140	75	-	-	-	-	-	-	-	-	-	-	-	-	-	-	-	800						
160	-	-	-	-	-	-	-	-	-	-	-	-	-	-	-	-	1 000						
190	-	-	-	-	-	-	-	-	-	-	-	-	-	-	-	-	1 250						
220	-	-	-	-	-	-	-	-	-	-	-	-	-	-	-	-	1 600						
250	-	-	-	-	-	-	-	-	-	-	-	-	-	-	-	-	2 000						

Table 8. 3 Tolerances for Metric Design Tapered Roller Bearings

Table 8. 3. 1 Tolerances for Inner Ring Bore Diameter and Running Accuracy

Nominal Bore Diameter d (mm)		Δ_{dmp}				Δ_{ds}		V_{dp}				V_{dmp}					
		Normal Class 6X		Class 6 Class 5		Class 4		Class 4		Normal Class 6X	Class 6	Class 5	Class 4	Normal Class 6X	Class 6	Class 5	Class 4
over	incl.	high	low	high	low	high	low	high	low	max.	max.	max.	max.	max.	max.	max.	max.
10	18	0	-8	0	-7	0	-5	0	-5	8	7	5	4	6	5	5	4
18	30	0	-10	0	-8	0	-6	0	-6	10	8	6	5	8	6	5	4
30	50	0	-12	0	-10	0	-8	0	-8	12	10	8	6	9	8	5	5
50	80	0	-15	0	-12	0	-9	0	-9	15	12	9	7	11	9	6	5
80	120	0	-20	0	-15	0	-10	0	-10	20	15	11	8	15	11	8	5
120	180	0	-25	0	-18	0	-13	0	-13	25	18	14	10	19	14	9	7
180	250	0	-30	0	-22	0	-15	0	-15	30	22	17	11	23	16	11	8
250	315	0	-35	0	-25	0	-18	0	-18	35	-	-	-	26	-	-	-
315	400	0	-40	0	-30	0	-23	0	-23	40	-	-	-	30	-	-	-
400	500	0	-45	0	-35	0	-27	0	-27	-	-	-	-	-	-	-	-
500	630	0	-50	0	-40	-	-	-	-	-	-	-	-	-	-	-	-
630	800	0	-75	0	-60	-	-	-	-	-	-	-	-	-	-	-	-

Remarks 1. The bore diameter "no-go side" tolerances (high) specified in this table do not necessarily apply within a distance of 1.2 times the chamfer dimension r (max.) from the ring face.
2. Some of these tolerances conform to the NSK Standard.

Table 8. 3. 2 Tolerances for Outer Ring Outside Diameter and Running Accuracy

Nominal Outside Diameter D (mm)		Δ_{Dmp}				Δ_{Ds}		V_{Dp}				V_{Dmp}					
		Normal Class 6X		Class 6 Class 5		Class 4		Class 4		Normal Class 6X	Class 6	Class 5	Class 4	Normal Class 6X	Class 6	Class 5	Class 4
over	incl.	high	low	high	low	high	low	high	low	max.	max.	max.	max.	max.	max.	max.	max.
18	30	0	-9	0	-8	0	-6	0	-6	9	8	6	5	7	6	5	4
30	50	0	-11	0	-9	0	-7	0	-7	11	9	7	5	8	7	5	5
50	80	0	-13	0	-11	0	-9	0	-9	13	11	8	7	10	8	6	5
80	120	0	-15	0	-13	0	-10	0	-10	15	13	10	8	11	10	7	5
120	150	0	-18	0	-15	0	-11	0	-11	18	15	11	8	14	11	8	6
150	180	0	-25	0	-18	0	-13	0	-13	25	18	14	10	19	14	9	7
180	250	0	-30	0	-20	0	-15	0	-15	30	20	15	11	23	15	10	8
250	315	0	-35	0	-25	0	-18	0	-18	35	25	19	14	26	19	13	9
315	400	0	-40	0	-28	0	-20	0	-20	40	28	22	15	30	21	14	10
400	500	0	-45	0	-33	0	-23	0	-23	45	-	-	-	34	-	-	-
500	630	0	-50	0	-38	0	-28	0	-28	50	-	-	-	38	-	-	-
630	800	0	-75	0	-45	-	-	-	-	-	-	-	-	-	-	-	-
800	1 000	0	-100	0	-60	-	-	-	-	-	-	-	-	-	-	-	-

Remarks 1. The outside diameter "no-go side" tolerances (low) specified in this table do not necessarily apply within a distance of 1.2 times the chamfer dimension r (max.) from the ring face.
2. Some of these tolerances conform to the NSK Standard.

Units : μm

K_{ia}				S_d		S_{ia}
Normal Class 6X	Class 6	Class 5	Class 4	Class 5	Class 4	Class 4
max.	max.	max.	max.	max.	max.	max.
15	7	3.5	2.5	7	3	3
18	8	4	3	8	4	4
20	10	5	4	8	4	4
25	10	5	4	8	5	4
30	13	6	5	9	5	5
35	18	8	6	10	6	7
50	20	10	8	11	7	8
60	25	13	10	13	8	10
70	30	15	12	15	10	14
70	35	18	14	19	13	17
85	40	20	-	22	-	-
100	45	22	-	27	-	-

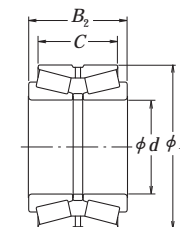
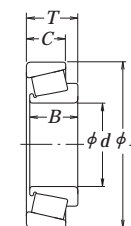

Units : μm

K_{ea}				S_D		S_{ea}
Normal Class 6X	Class 6	Class 5	Class 4	Class 5	Class 4	Class 4
max.	max.	max.	max.	max.	max.	max.
18	9	6	4	8	4	5
20	10	7	5	8	4	5
25	13	8	5	8	4	5
35	18	10	6	9	5	6
40	20	11	7	10	5	7
45	23	13	8	10	5	8
50	25	15	10	11	7	10
60	30	18	11	13	8	10
70	35	20	13	13	10	13
80	40	23	15	15	11	15
100	50	25	18	18	13	18
120	60	30	-	20	-	-
120	75	35	-	23	-	-

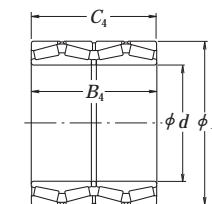
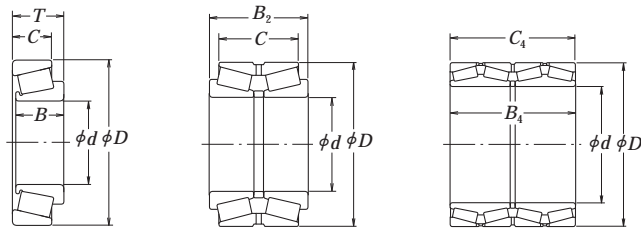

Table 8. 3 Tolerances for Metric Design
Table 8. 3. 3 Tolerances for Width, Overall Bearing Width,

Nominal Bore Diameter d (mm)		ΔB_s						ΔC_s						ΔT_s					
		Normal Class 6		Class 6X		Class 5 Class 4		Normal Class 6		Class 6X		Class 5 Class 4		Normal Class 6		Class 6X		Class 5 Class 4	
over	incl.	high	low	high	low	high	low	high	low	high	low	high	low	high	low	high	low	high	low
10	18	0	-120	0	-50	0	-200	0	-120	0	-100	0	-200	+200	0	+100	0	+200	-200
18	30	0	-120	0	-50	0	-200	0	-120	0	-100	0	-200	+200	0	+100	0	+200	-200
30	50	0	-120	0	-50	0	-240	0	-120	0	-100	0	-240	+200	0	+100	0	+200	-200
50	80	0	-150	0	-50	0	-300	0	-150	0	-100	0	-300	+200	0	+100	0	+200	-200
80	120	0	-200	0	-50	0	-400	0	-200	0	-100	0	-400	+200	-200	+100	0	+200	-200
120	180	0	-250	0	-50	0	-500	0	-250	0	-100	0	-500	+350	-250	+150	0	+350	-250
180	250	0	-300	0	-50	0	-600	0	-300	0	-100	0	-600	+350	-250	+150	0	+350	-250
250	315	0	-350	0	-50	0	-700	0	-350	0	-100	0	-700	+350	-250	+200	0	+350	-250
315	400	0	-400	0	-50	0	-800	0	-400	0	-100	0	-800	+400	-400	+200	0	+400	-400
400	500	0	-450	-	-	0	-800	0	-450	-	-	0	-800	+400	-400	-	-	+400	-400
500	630	0	-500	-	-	0	-800	0	-500	-	-	0	-800	+500	-500	-	-	+500	-500
630	800	0	-750	-	-	0	-800	0	-750	-	-	0	-800	+600	-600	-	-	+600	-600

Remarks The effective width of an inner ring with rollers T_1 is defined as the overall bearing width of an inner ring with rollers combined with a master outer ring.
The effective width of an outer ring T_2 is defined as the overall bearing width of an outer ring combined with a master inner ring with rollers.



Tapered Roller Bearings
and Combined Bearing Width

Units : μm

Ring Width with Rollers ΔT_{1s}				Outer Ring Effective Width Deviation ΔT_{2s}				Overall Combined Bearing Width Deviation ΔB_{2s}				Nominal Bore Diameter d (mm)	
Normal		Class 6X		Normal		Class 6X		All classes of double-row bearings		All classes of four-row bearings		over	incl.
high	low	high	low	high	low	high	low	high	low	high	low	high	low
+100	0	+50	0	+100	0	+50	0	+200	-200	-	-	10	18
+100	0	+50	0	+100	0	+50	0	+200	-200	-	-	18	30
+100	0	+50	0	+100	0	+50	0	+200	-200	-	-	30	50
+100	0	+50	0	+100	0	+50	0	+300	-300	+300	-300	50	80
+100	-100	+50	0	+100	-100	+50	0	+300	-300	+400	-400	80	120
+150	-150	+50	0	+200	-100	+100	0	+400	-400	+500	-500	120	180
+150	-150	+50	0	+200	-100	+100	0	+450	-450	+600	-600	180	250
+150	-150	+100	0	+200	-100	+100	0	+550	-550	+700	-700	250	315
+200	-200	+100	0	+200	-200	+100	0	+600	-600	+800	-800	315	400
-	-	-	-	-	-	-	-	+700	-700	+900	-900	400	500
-	-	-	-	-	-	-	-	+800	-800	+1000	-1000	500	630
-	-	-	-	-	-	-	-	+1200	-1200	+1500	-1500	630	800

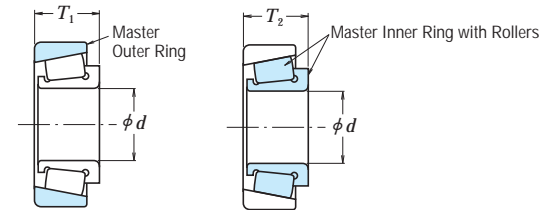

Table 8. 4 Tolerances for Inch Design Tapered Roller Bearings

(Refer to page A58 Table 8. 1 for the tolerance class "CLASS **" that is the tolerance classes of ANSI/ABMA.)

Table 8. 4. 1 Tolerances for Inner Ring Bore Diameter

Units : μm

Nominal Bore Diameter d				Δ_{ds}					
over		incl.		CLASS 4, 2		CLASS 3, 0		CLASS 00	
(mm)	1/25.4	(mm)	1/25.4	high	low	high	low	high	low
-	-	76.200	3.0000	+ 13	0	+13	0	+8	0
76.200	3.0000	266.700	10.5000	+ 25	0	+13	0	+8	0
266.700	10.5000	304.800	12.0000	+ 25	0	+13	0	-	-
304.800	12.0000	609.600	24.0000	+ 51	0	+25	0	-	-
609.600	24.0000	914.400	36.0000	+ 76	0	+38	0	-	-
914.400	36.0000	1 219.200	48.0000	+102	0	+51	0	-	-
1 219.200	48.0000	-	-	+127	0	+76	0	-	-

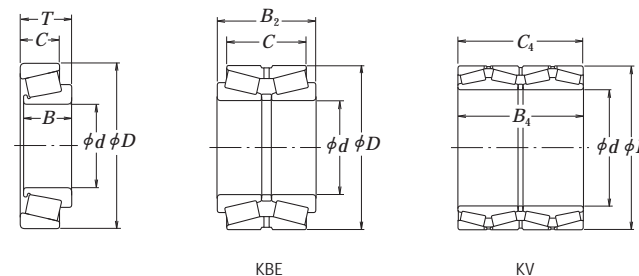

Table 8. 4. 2 Tolerances for Outer Ring Outside Diameter

Nominal Outside Diameter D				Δ_{Ds}					
over		incl.		CLASS 4, 2		CLASS 3, 0		CLASS 00	
(mm)	1/25.4	(mm)	1/25.4	high	low	high	low	high	low
-	-	266.700	10.5000	+ 25	0	+13	0	+8	0
266.700	10.5000	304.800	12.0000	+ 25	0	+13	0	+8	0
304.800	12.0000	609.600	24.0000	+ 51	0	+25	0	-	-
609.600	24.0000	914.400	36.0000	+ 76	0	+38	0	-	-
914.400	36.0000	1 219.200	48.0000	+102	0	+51	0	-	-
1 219.200	48.0000	-	-	+127	0	+76	0	-	-

and Radial Runout of Inner and Outer Rings

Units : μm

$K_{ia} \cdot K_{ea}$				
CLASS 4	CLASS 2	CLASS 3	CLASS 0	CLASS 00
max.	max.	max.	max.	max.
51	38	8	4	2
51	38	8	4	2
51	38	18	-	-
76	51	51	-	-
76	-	76	-	-
76	-	76	-	-

Table 8. 4. 3 Tolerances for

Nominal Bore Diameter d				Δ_{Ts}									
over		incl.		CLASS 4		CLASS 2		CLASS 3				CLASS 0, 00	
								$D \leq 508.000$ (mm)		$D > 508.000$ (mm)			
(mm)	1/25.4	(mm)	1/25.4	high	low	high	low	high	low	high	low	high	low
-	-	101.600	4.0000	+203	0	+203	0	+203	-203	+203	-203	+203	-203
101.600	4.0000	304.800	12.0000	+356	-254	+203	0	+203	-203	+203	-203	+203	-203
304.800	12.0000	609.600	24.0000	+381	-381	+381	-381	+203	-203	+381	-381	-	-
609.600	24.0000	-	-	+381	-381	-	-	+381	-381	+381	-381	-	-

Overall Width and Combined Width

Units : μm

Double-Row Bearings (KBE Type)										Four-Row Bearings (KV Type)	
Δ_{B2s}										$\Delta_{B4s}, \Delta_{C4s}$	
CLASS 4		CLASS 2		CLASS 3				CLASS 0, 00		CLASS 4, 3	
				$D \leq 508.000$ (mm)		$D > 508.000$ (mm)					
high	low	high	low	high	low	high	low	high	low	high	low
+406	0	+406	0	+406	-406	+406	-406	+406	-406	+1 524	-1 524
+711	-508	+406	-203	+406	-406	+406	-406	+406	-406	+1 524	-1 524
+762	-762	+762	-762	+406	-406	+762	-762	-	-	+1 524	-1 524
+762	-762	-	-	+762	-762	+762	-762	-	-	+1 524	-1 524

Table 8. 5 Tolerances
Table 8. 5. 1 Tolerances for Inner Rings

Nominal Bore Diameter d (mm)		Δ_{dmp}						V_{dp}			V_{dmp}			Δ_{Bs} (or Δ_{Cs}) (1)			
		Normal		Class 6		Class 5		Normal	Class 6	Class 5	Normal	Class 6	Class 5	Normal Class 6		Class 5	
		over	incl.	high	low	high	low	high	low	max.	max.	max.	max.	max.	max.	high	low
2.5	10	0	-8	0	-7	0	-5	6	5	4	6	5	3	0	-120	0	-40
10	18	0	-8	0	-7	0	-5	6	5	4	6	5	3	0	-120	0	-80
18	30	0	-10	0	-8	0	-6	8	6	5	8	6	3	0	-120	0	-120

Note (1) The width deviation and width variation of an outer ring is determined according to the inner ring of the same bearing.

Remarks The bore diameter "no-go side" tolerances (high) specified in this table do not necessarily apply within a distance of 1.2 times the chamfer dimension r (max.) from the ring face.

Table 8. 5. 2 Tolerances

Nominal Outside Diameter D (mm)		Δ_{Dmp}												V_{Dp}		
		Bearing Series E						Bearing Series EN						Normal	Class 6	Class 5
		Normal		Class 6		Class 5		Normal		Class 6		Class 5				
over	incl.	high	low	high	low	high	low	high	low	high	low	high	low	max.	max.	max.
6	18	+8	0	+7	0	+5	0	0	-8	0	-7	0	-5	6	5	4
18	30	+9	0	+8	0	+6	0	0	-9	0	-8	0	-6	7	6	5
30	50	+11	0	+9	0	+7	0	0	-11	0	-9	0	-7	8	7	5

Remarks The outside diameter "no-go side" tolerances (low) do not necessarily apply within a distance of 1.2 times the chamfer dimension r (max.) from the ring face.

for Magneto Bearings
and Width of Outer Rings

Units : μm

V_{Bs} (or V_{Cs}) (1)		Δ_{Ts}		K_{ia}			S_d	S_{ia}								
									Normal Class 6	Class 5	Normal Class 6 Class 5	Normal	Class 6	Class 5	Class 5	Class 5
									max.	max.	high	low	max.	max.	max.	max.
15	5	+120	-120	10	6	4	7	7								
20	5	+120	-120	10	7	4	7	7								
20	5	+120	-120	13	8	4	8	8								

for Outer Rings

Units : μm

V_{Dmp}			K_{ea}			S_{ea}	S_D								
								Normal	Class 6	Class 5	Normal	Class 6	Class 5	Class 5	Class 5
								max.	max.	max.	max.	max.	max.	max.	max.
6	5	3	15	8	5	8	8								
7	6	3	15	9	6	8	8								
8	7	4	20	10	7	8	8								

Table 8. 6 Tolerances for Thrust Ball Bearings

Table 8. 6. 1 Tolerances for Shaft Washer Bore Diameter and Running Accuracy

Units : μm

Nominal Bore Diameter d or d_2 (mm)		Δ_{dmp} or Δ_{d2mp}				V_{dp} or V_{d2p}		S_f or S_e (1)			
		over	incl.	high	low	high	low	max.	max.	max.	max.
-	18	0	- 8	0	- 7	6	5	10	5	3	2
18	30	0	- 10	0	- 8	8	6	10	5	3	2
30	50	0	- 12	0	- 10	9	8	10	6	3	2
50	80	0	- 15	0	- 12	11	9	10	7	4	3
80	120	0	- 20	0	- 15	15	11	15	8	4	3
120	180	0	- 25	0	- 18	19	14	15	9	5	4
180	250	0	- 30	0	- 22	23	17	20	10	5	4
250	315	0	- 35	0	- 25	26	19	25	13	7	5
315	400	0	- 40	0	- 30	30	23	30	15	7	5
400	500	0	- 45	0	- 35	34	26	30	18	9	6
500	630	0	- 50	0	- 40	38	30	35	21	11	7
630	800	0	- 75	0	- 50	-	-	40	25	13	8
800	1 000	0	- 100	-	-	-	-	45	30	15	-
1 000	1 250	0	- 125	-	-	-	-	50	35	18	-

Note (1) For double-direction bearings, the thickness variation doesn't depend on the bore diameter d_2 , but on d for single-direction bearings with the same D in the same diameter series. The thickness variation of housing washers, S_e , applies only to flat-seat thrust bearings.

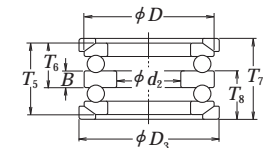
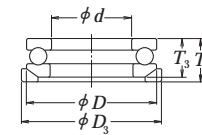
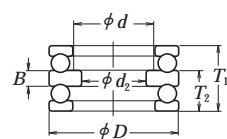
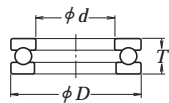

Table 8. 6. 2 Tolerances for Outside Diameter of Housing Washers and Aligning Seat Washers

Units : μm

Nominal Outside Diameter of Bearing or Aligning Seat Washer D or D_3 (mm)		Δ_{Dmp}						V_{Dp}		Aligning Seat Washer Outside Diameter Deviation Δ_{D3s}	
		over	incl.	high	low	high	low	high	low	max.	max.
10	18	0	- 11	0	- 7	0	- 17	8	5	0	- 25
18	30	0	- 13	0	- 8	0	- 20	10	6	0	- 30
30	50	0	- 16	0	- 9	0	- 24	12	7	0	- 35
50	80	0	- 19	0	- 11	0	- 29	14	8	0	- 45
80	120	0	- 22	0	- 13	0	- 33	17	10	0	- 60
120	180	0	- 25	0	- 15	0	- 38	19	11	0	- 75
180	250	0	- 30	0	- 20	0	- 45	23	15	0	- 90
250	315	0	- 35	0	- 25	0	- 53	26	19	0	- 105
315	400	0	- 40	0	- 28	0	- 60	30	21	0	- 120
400	500	0	- 45	0	- 33	0	- 68	34	25	0	- 135
500	630	0	- 50	0	- 38	0	- 75	38	29	0	- 180
630	800	0	- 75	0	- 45	0	- 113	55	34	0	- 225
800	1 000	0	- 100	-	-	-	-	75	-	-	-
1 000	1 250	0	- 125	-	-	-	-	-	-	-	-
1 250	1 600	0	- 160	-	-	-	-	-	-	-	-

Table 8. 6. 3 Tolerances for Thrust Ball Bearing Height and Central Washer Height

Units : μm

Nominal Bore Diameter $d^{(1)}$ (mm)		Flat Seat Type				Aligning Seat Washer Type				With Aligning Seat Washer				Height Deviation of Central Washer Δ_{Bs}	
		Δ_{T_s} or $\Delta_{T_{2s}}$		$\Delta_{T_{1s}}$		$\Delta_{T_{3s}}$ or $\Delta_{T_{6s}}$		$\Delta_{T_{3s}}$		$\Delta_{T_{4s}}$ or $\Delta_{T_{8s}}$		$\Delta_{T_{7s}}$			
		Normal, Class 6 Class 5, Class 4		Normal, Class 6 Class 5, Class 4		Normal Class 6		Normal Class 6		Normal Class 6		Normal Class 6		Normal, Class 6 Class 5, Class 4	
over	incl.	high	low	high	low	high	low	high	low	high	low	high	low	high	low
-	30	0	-75	+50	-150	0	-75	+50	-150	+50	-75	+150	-150	0	-50
30	50	0	-100	+75	-200	0	-100	+75	-200	+50	-100	+175	-200	0	-75
50	80	0	-125	+100	-250	0	-125	+100	-250	+75	-125	+250	-250	0	-100
80	120	0	-150	+125	-300	0	-150	+125	-300	+75	-150	+275	-300	0	-125
120	180	0	-175	+150	-350	0	-175	+150	-350	+100	-175	+350	-350	0	-150
180	250	0	-200	+175	-400	0	-200	+175	-400	+100	-200	+375	-400	0	-175
250	315	0	-225	+200	-450	0	-225	+200	-450	+125	-225	+450	-450	0	-200
315	400	0	-300	+250	-600	0	-300	+250	-600	+150	-275	+550	-550	0	-250

Note (1) For double-direction bearings, its classification depends on d for single-direction bearings with the same D in the same diameter series.

Remarks Δ_{T_s} in the table is the deviation in the respective heights T in figures below.

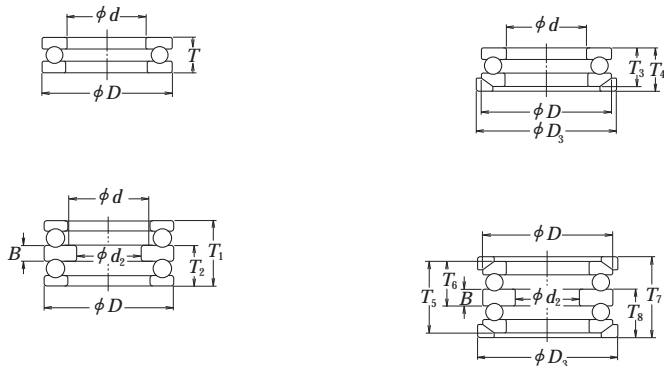

Table 8. 7 Tolerances for Thrust Spherical Roller Bearings

Table 8. 7. 1 Tolerances for Bore Diameters of Shaft Rings and Height (Class Normal)

Units : μm

Nominal Bore Diameter d (mm)		Δ_{dmp}		V_{dp}	Reference		
					S_d	Δ_{T_s}	
over	incl.	high	low	max.	max.	high	low
50	80	0	-15	11	25	+150	-150
80	120	0	-20	15	25	+200	-200
120	180	0	-25	19	30	+250	-250
180	250	0	-30	23	30	+300	-300
250	315	0	-35	26	35	+350	-350
315	400	0	-40	30	40	+400	-400
400	500	0	-45	34	45	+450	-450

Remarks The bore diameter "no-go side" tolerances (high) specified in this table do not necessarily apply within a distance of 1.2 times the chamfer dimension r (max.) from the ring face.

Table 8. 7. 2 Tolerances for Housing Ring Diameter (Class Normal)

Units : μm

Nominal Outside Diameter D (mm)		Δ_{Dmp}	
over	incl.	high	low
120	180	0	-25
180	250	0	-30
250	315	0	-35
315	400	0	-40
400	500	0	-45
500	630	0	-50
630	800	0	-75
800	1 000	0	-100

Remarks The outside diameter "no-go side" tolerances (low) specified in this table do not necessarily apply within a distance of 1.2 times the chamfer dimension r (max.) from the ring face.

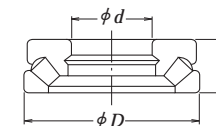

Table 8. 8 Tolerances of
CLASS 5P, CLASS 7P, and CLASS 9P

(1) Tolerances for Inner Rings

Nominal Bore Diameter d (mm)	Δ_{dmp}				Δ_{ds}				V_{dp}		V_{dmp}		Δ_{Bs}	
	CLASS 5P CLASS 7P		CLASS 9P		CLASS 5P CLASS 7P		CLASS 9P		CLASS 5P CLASS 7P	CLASS 9P	CLASS 5P CLASS 7P	CLASS 9P	Single Brgs	
	high	low	high	low	high	low	high	low	max.	max.	max.	max.	high	low
over incl.	high	low	high	low	high	low	high	low	max.	max.	max.	max.	high	low
- 10	0	-5.1	0	-2.5	0	-5.1	0	-2.5	2.5	1.3	2.5	1.3	0	-25.4
10 18	0	-5.1	0	-2.5	0	-5.1	0	-2.5	2.5	1.3	2.5	1.3	0	-25.4
18 30	0	-5.1	0	-2.5	0	-5.1	0	-2.5	2.5	1.3	2.5	1.3	0	-25.4

Note (1) Applicable to bearings for which the axial clearance (preload) is to be adjusted by combining two selected bearings.
Remarks For the CLASS 3P and the tolerances of Metric design Instrument Ball Bearings, it is advisable to consult NSK.

(2) Tolerances for

Nominal Outside Diameter D (mm)	Δ_{Dmp}				Δ_{Ds}				V_{Dp}			V_{Dmp}				
	CLASS 5P CLASS 7P		CLASS 9P		CLASS 5P CLASS 7P		CLASS 9P		CLASS 5P CLASS 7P	CLASS 9P	CLASS 5P CLASS 7P	CLASS 9P				
	high	low	high	low	high	low	high	low	Open	Shielded Sealed	Open	Open	Shielded Sealed	Open		
over incl.	high	low	high	low	high	low	high	low	max.	max.	max.	max.	max.	max.		
- 18	0	-5.1	0	-2.5	0	-5.1	+1	-6.1	0	-2.5	2.5	5.1	1.3	2.5	5.1	1.3
18 30	0	-5.1	0	-3.8	0	-5.1	+1	-6.1	0	-3.8	2.5	5.1	2	2.5	5.1	2
30 50	0	-5.1	0	-3.8	0	-5.1	+1	-6.1	0	-3.8	2.5	5.1	2	2.5	5.1	2

Notes (1) Applicable to flange width variation for flanged bearings.
(2) Applicable to flange back face.

Instrument Ball Bearings (Inch design)

(ANSI/ABMA Equivalent)

and Width of Outer Rings

Units : μm

(or Δ_{Cs})		V_{Bs}			K_{ia}			S_{ia}			S_d		
Combined Brgs (1)		CLASS 5P	CLASS 7P	CLASS 9P	CLASS 5P	CLASS 7P	CLASS 9P	CLASS 5P	CLASS 7P	CLASS 9P	CLASS 5P	CLASS 7P	CLASS 9P
high	low	max.	max.	max.	max.	max.	max.	max.	max.	max.	max.	max.	max.
0	-400	5.1	2.5	1.3	3.8	2.5	1.3	7.6	2.5	1.3	7.6	2.5	1.3
0	-400	5.1	2.5	1.3	3.8	2.5	1.3	7.6	2.5	1.3	7.6	2.5	1.3
0	-400	5.1	2.5	1.3	3.8	3.8	2.5	7.6	3.8	1.3	7.6	3.8	1.3

Outer Rings

Units : μm

V_{Cs} (1)			S_D			K_{ea}			S_{ea}			Deviation of Flange Outside Diameter Δ_{Dis}		Deviation of Flange Width Δ_{C1s}		Flange Backface Runout with Raceway (2) S_{ea1}
CLASS 5P	CLASS 7P	CLASS 9P	CLASS 5P	CLASS 7P	CLASS 9P	CLASS 5P	CLASS 7P	CLASS 9P	CLASS 5P	CLASS 7P	CLASS 9P	high	low	high	low	max.
5.1	2.5	1.3	7.6	3.8	1.3	5.1	3.8	1.3	7.6	5.1	1.3	0	-25.4	0	-50.8	7.6
5.1	2.5	1.3	7.6	3.8	1.3	5.1	3.8	2.5	7.6	5.1	2.5	0	-25.4	0	-50.8	7.6
5.1	2.5	1.3	7.6	3.8	1.3	5.1	5.1	2.5	7.6	5.1	2.5	0	-25.4	0	-50.8	7.6

Table 8. 9 Chamfer Dimension Limits (for Metric Design Bearings)

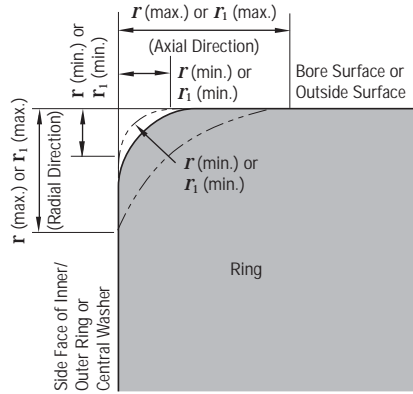

r : Chamfer Dimension of Inner/Outer Ring
 r_1 : Chamfer Dimension of Inner/Outer Ring (Front Side) or of Central Washer of Thrust Ball Bearings

Remarks The precise shape of chamfer surfaces has not been specified but its profile in the axial plane shall not intersect an arc of radius r (min.) or r_1 (min.) touching the side face of an inner ring or central washer and bore surface, or the side face of an outer ring and outside surface.

Table 8. 9. 1 Chamfer Dimension Limits for Radial Bearings (excluding Tapered Roller Bearings)

Permissible Chamfer Dimension for Inner/Outer Rings r (min.) or r_1 (min.)	Nominal Bore Diameter d		Permissible Chamfer Dimension for Inner/Outer Rings r (max.) or r_1 (max.)		Reference Corner Radius of Shaft or Housing r_a max.
	over	incl.	Radial Direction	Axial Direction	
	Units : mm				
0.05	-	-	0.1	0.2	0.05
0.08	-	-	0.16	0.3	0.08
0.1	-	-	0.2	0.4	0.1
0.15	-	-	0.3	0.6	0.15
0.2	-	-	0.5	0.8	0.2
0.3	-	40	0.6	1	0.3
	40	-	0.8	1	
0.6	-	40	1	2	0.6
	40	-	1.3	2	
1	-	50	1.5	3	1
	50	-	1.9	3	
1.1	-	120	2	3.5	1
	120	-	2.5	4	
1.5	-	120	2.3	4	1.5
	120	-	3	5	
2	-	80	3	4.5	2
	80	220	3.5	5	
	220	-	3.8	6	
2.1	-	280	4	6.5	2
	280	-	4.5	7	
2.5	-	100	3.8	6	2
	100	280	4.5	6	
	280	-	5	7	
3	-	280	5	8	2.5
	280	-	5.5	8	
4	-	-	6.5	9	3
5	-	-	8	10	4
6	-	-	10	13	5
7.5	-	-	12.5	17	6
9.5	-	-	15	19	8
12	-	-	18	24	10
15	-	-	21	30	12
19	-	-	25	38	15

Remarks For bearings with nominal widths less than 2mm, the value of r (max.) in the axial direction is the same as that in the radial direction.

Table 8. 9. 2 Chamfer Dimension Limits for Tapered Roller Bearings

Permissible Chamfer Dimension for Inner/Outer Rings r (min.)	Nominal Bore or Nominal Outside Diameter (1) d or D		Permissible Chamfer Dimension for Inner/Outer Rings r (max.)		Reference Corner Radius of Shaft or Housing r_a max.
	over	incl.	Radial Direction	Axial Direction	
	Units : mm				
0.15	-	-	0.3	0.6	0.15
0.3	-	40	0.7	1.4	0.3
	40	-	0.9	1.6	
0.6	-	40	1.1	1.7	0.6
	40	-	1.3	2	
1	-	50	1.6	2.5	1
	50	-	1.9	3	
1.5	-	120	2.3	3	1.5
	120	250	2.8	3.5	
	250	-	3.5	4	
2	-	120	2.8	4	2
	120	250	3.5	4.5	
	250	-	4	5	
2.5	-	120	3.5	5	2
	120	250	4	5.5	
	250	-	4.5	6	
3	-	120	4	5.5	2.5
	120	250	4.5	6.5	
	250	400	5	7	
	400	-	5.5	7.5	
4	-	120	5	7	3
	120	250	5.5	7.5	
	250	400	6	8	
	400	-	6.5	8.5	
5	-	180	6.5	8	4
	180	-	7.5	9	
6	-	180	7.5	10	5
	180	-	9	11	

Note (1) Inner Rings are classified by d and Outer Rings by D .

Table 8. 9. 3 Chamfer Dimension Limits for Thrust Bearings

Permissible Chamfer Dimension for Shaft (or Central)/Housing Washers r (min.) or r_1 (min.)	Permissible Chamfer Dimension for Shaft (or Central)/Housing Washers r (max.) or r_1 (max.)		Reference Corner Radius of Shaft or Housing r_a max.
	Radial	Axial	
	Units : mm		
0.05	0.1		0.05
0.08	0.16		0.08
0.1	0.2		0.1
0.15	0.3		0.15
0.2	0.5		0.2
0.3	0.8		0.3
0.6	1.5		0.6
1	2.2		1
1.1	2.7		1
1.5	3.5		1.5
2	4		2
2.1	4.5		2
3	5.5		2.5
4	6.5		3
5	8		4
6	10		5
7.5	12.5		6
9.5	15		8
12	18		10
15	21		12
19	25		15

Table 8.10 Tolerances for Tapered Bores (Class Normal)

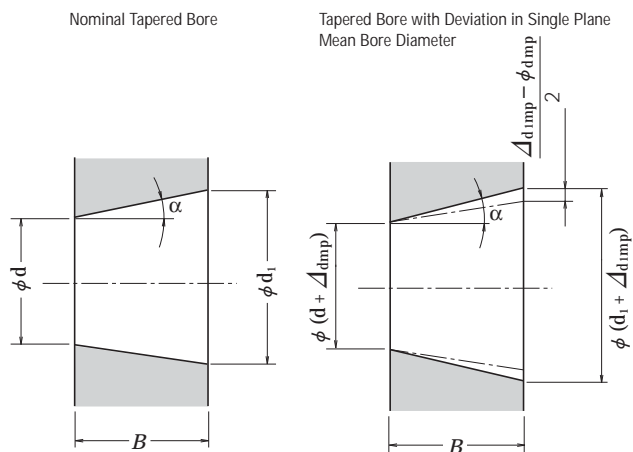

d : Nominal Bore Diameter
 d_1 : Theoretical Diameter of Larger End of Tapered Bore
 Taper 1:12 $d_1 = d + 1/12 B$ Taper 1:30 $d_1 = d + /30 B$
 Δ_{d1mp} : Single Plane Mean Bore Diameter Deviation in Theoretical Diameter of Smaller End of Bore
 Δ_{d1mp} : Single Plane Mean Bore Diameter Deviation in Theoretical Diameter of Larger End of Bore
 V_{dp} : Bore diameter variation in a single radial plane
 B : Nominal Inner Ring width
 α : Half of Taper Angle of Tapered Bore

Taper 1:12
 $\alpha = 2^\circ 23' 9.4''$
 $= 2.38594^\circ$
 $= 0.041643 \text{ rad}$

Taper 1:30
 $\alpha = 57' 17.4''$
 $= 0.95484^\circ$
 $= 0.016665 \text{ rad}$

Taper 1 : 12

Units : μm

Nominal Bore Diameter d (mm)		Δ_{d1mp}		$\Delta_{d1mp} - \Delta_{d1mp}$		V_{dp} (1) (2)
over	incl.	high	low	high	low	max.
18	30	+33	0	+21	0	13
30	50	+39	0	+25	0	16
50	80	+46	0	+30	0	19
80	120	+54	0	+35	0	22
120	180	+63	0	+40	0	40
180	250	+72	0	+46	0	46
250	315	+81	0	+52	0	52
315	400	+89	0	+57	0	57
400	500	+97	0	+63	0	63
500	630	+110	0	+70	0	70
630	800	+125	0	+80	0	-
800	1 000	+140	0	+90	0	-
1 000	1 250	+165	0	+105	0	-
1 250	1 600	+195	0	+125	0	-

Notes (1) Applicable to all radial planes of tapered bores.
 (2) Not applicable to diameter series 7 and 8.

Taper 1 : 30

Units : μm

Nominal Bore Diameter d (mm)		Δ_{d1mp}		$\Delta_{d1mp} - \Delta_{d1mp}$		V_{dp} (1) (2)
over	incl.	high	low	high	low	max.
80	120	+20	0	+35	0	22
120	180	+25	0	+40	0	40
180	250	+30	0	+46	0	46
250	315	+35	0	+52	0	52
315	400	+40	0	+57	0	57
400	500	+45	0	+63	0	63
500	630	+50	0	+70	0	70

Notes (1) Applicable to all radial planes of tapered bores.
 (2) Not applicable to diameter series 7 and 8.
 Remarks For a value exceeding 630 mm, please contact NSK.

8.2 Selection of Accuracy Classes

For general applications, Class Normal tolerances are adequate in nearly all cases for satisfactory performance, but for the following applications, bearings having an accuracy class of 5,4 or higher are more suitable.

For reference, in Table 8.11, examples of applications and appropriate tolerance classes are listed for various bearing requirements and operating conditions.

Table 8.11 Typical Tolerance Classes for Specific Applications (Reference)

Bearing Requirement, Operating Conditions	Examples of Applications	Tolerance Classes
High running accuracy is required	VTR Drum Spindles	P5
	Magnetic Disk Spindles for Computers	P5, P4, P2
	Machine-Tool Main Spindles	P5, P4, P2
	Rotary Printing Presses	P5
	Rotary Tables of Vertical Presses, etc.	P5, P4
	Roll Necks of Cold Rolling Mill Backup Rolls	Higher than P4
Extra high speed is required	Slewing Bearings for Parabolic Antennas	Higher than P4
	Dental Drills	CLASS 7P, CLASS 5P
	Gyroscopes	CLASS 7P, P4
	High Frequency Spindles	CLASS 7P, P4
	Superchargers	P5, P4
	Centrifugal Separators	P5, P4
Low torque and low torque variation are required	Main Shafts of Jet Engines	Higher than P4
	Gyroscope Gimbals	CLASS 7P, P4
	Servomechanisms	CLASS 7P, CLASS 5P
	Potentiometric Controllers	CLASS 7P

9. FITS AND INTERNAL CLEARANCES

9.1 Fits

9.1.1 Importance of Proper Fits

In the case of a rolling bearing with the inner ring fitted to the shaft with only slight interference, a harmful circumferential slipping may occur between the inner ring and shaft. This slipping of the inner ring, which is called "creep", results in a circumferential displacement of the ring relative to the shaft if the interference fit is not sufficiently tight. When creep occurs, the fitted surfaces become abraded, causing wear and considerable damage to the shaft. Abnormal heating and vibration may also occur due to abrasive metallic particles entering the interior of the bearing. It is important to prevent creep by having sufficient interference to firmly secure that ring which rotates to either the shaft or housing. Creep cannot always be eliminated using only axial tightening through the bearing ring faces. Generally, it is not necessary, however, to provide interference for rings subjected only to stationary loads. Fits are sometimes made without any interference for either the inner or outer ring, to accommodate certain operating conditions, or to facilitate mounting and dismounting. In this case, to prevent damage to the fitting surfaces due to creep, lubrication of other applicable methods should be considered.

9.1.2 Selection of Fit

(1) Load Conditions and Fit

The proper fit may be selected from Table 9.1 based on the load and operating conditions.

(2) Magnitude of Load and Interference

The interference of the inner ring is slightly reduced by the bearing load; therefore, the loss of interference should be estimated using the following equations:

$$\left. \begin{aligned} \Delta d_i &= 0.08 \sqrt{\frac{d}{B}} F_r \times 10^{-3} \dots\dots (N) \\ \Delta d_i &= 0.25 \sqrt{\frac{d}{B}} F_r \times 10^{-3} \dots\dots \{kgf\} \end{aligned} \right\} \dots (9.1)$$

where Δd_i : Interference decrease of inner ring (mm)
 d : Bearing bore diameter (mm)
 B : Nominal inner ring width (mm)
 F_r : Radial load applied on bearing (N), {kgf}

Therefore, the effective interference Δd should be larger than the interference given by Equation (9.1). However, in the case of heavy loads where the radial load exceeds 20% of the basic static load rating C_{0r} , under the operating condition, interference often becomes shortage. Therefore, interference should be estimated using Equation (9.2):

$$\left. \begin{aligned} \Delta d &\geq 0.02 \frac{F_r}{B} \times 10^{-3} \dots\dots (N) \\ \Delta d &\geq 0.2 \frac{F_r}{B} \times 10^{-3} \dots\dots \{kgf\} \end{aligned} \right\} \dots\dots (9.2)$$

where Δd : Effective interference (mm)
 F_r : Radial load applied on bearing (N), {kgf}
 B : Nominal inner ring width (mm)

(3) Interference Variation Caused by Temperature Difference between Bearing and Shaft or Housing

The effective interference decreases due to the increasing bearing temperature during operation. If the temperature difference between the bearing and housing is ΔT (°C), then the temperature difference between the fitted surfaces of the shaft and inner ring is estimated to be about (0.1-0.15) ΔT in case that the shaft is cooled. The decrease in the interference of the inner ring due to this temperature difference Δd_T may be calculated using Equation (9.3):

$$\Delta d_T = (0.10 \text{ to } 0.15) \times \Delta T \alpha \cdot d \approx 0.0015 \Delta T \cdot d \times 10^{-3} \dots\dots\dots (9.3)$$

where Δd_T : Decrease in interference of inner ring due to temperature difference (mm)
 ΔT : Temperature difference between bearing interior and surrounding parts (°C)
 α : Coefficient of linear expansion of bearing steel = 12.5×10^{-6} (1/°C)
 d : Bearing nominal bore diameter (mm)

In addition, depending on the temperature difference between the outer ring and housing, or difference in their coefficients of linear expansion, the interference may increase.

(4) Effective Interference and Finish of Shaft and Housing

Since the roughness of fitted surfaces is reduced during fitting, the effective interference becomes less than the apparent interference. The amount of this interference decrease varies depending on the

roughness of the surfaces and may be estimated using the following equations:

$$\text{For ground shafts } \Delta d = \frac{d}{d+2} \Delta d_a \dots\dots\dots (9.4)$$

$$\text{For machined shafts } \Delta d = \frac{d}{d+3} \Delta d_a \dots\dots\dots (9.5)$$

where Δd : Effective interference (mm)
 Δd_a : Apparent interference (mm)
 d : Bearing nominal bore diameter (mm)

According to Equations (9.4) and (9.5), the effective interference of bearings with a bore diameter of 30 to 150 mm is about 95% of the apparent interference.

(5) Fitting Stress and Ring Expansion and Contraction

When bearings are mounted with interference on a shaft or in a housing, the rings either expand or contract and stress is produced. Excessive interference may damage the bearings; therefore, as a general guide, the maximum interference should be kept under approximately 7/10 000 of the shaft diameter. The pressure between fitted surfaces, expansion or contraction of the rings, and circumferential stress may be calculated using the equations in Section 15.2, Fitting(1) (Pages A130 and A131).

9.1.3 Recommended Fits

As described previously, many factors, such as the characteristics and magnitude of bearing load, temperature differences, means of bearing mounting and dismounting, must be considered when selecting the proper fit. If the housing is thin or the bearing is mounted on a hollow shaft, a tighter than usual fit is necessary. A split housing often deforms the bearing into an oval shape; therefore, a split housing should be avoided when a tight fit with the outer ring is required. The fits of both the inner and outer rings should be tight in applications where the shaft is subjected to considerable vibration. The recommended fits for some common applications are shown in Table 9.2 to 9.7. In the case of unusual operating conditions, it is advisable to consult NSK. For the accuracy and surface finish of shafts and housings, please refer to Section 11.1 (Page A100).

Table 9.1 Loading Conditions and Fits

Load Application	Bearing Operation		Load Conditions	Fitting	
	Inner Ring	Outer Ring		Inner Ring	Outer Ring
	Rotating	Stationary	Rotating Inner Ring Load	Tight Fit	Loose Fit
	Stationary	Rotating	Stationary Outer Ring Load		
	Stationary	Rotating	Rotating Outer Ring Load	Loose Fit	Tight Fit
	Rotating	Stationary	Stationary Inner Ring Load		
Direction of load indeterminate due to variation of direction or unbalanced load	Rotating or Stationary	Rotating or Stationary	Direction of Load Indeterminate	Tight Fit	Tight Fit

Table 9.2 Fits of Radial Bearings with Shafts

Load Conditions		Examples	Shaft Diameter (mm)			Tolerance of Shaft	Remarks
			Ball Brgs	Cylindrical Roller Brgs, Tapered Roller Brgs	Spherical Roller Brgs		
Radial Bearings with Cylindrical Bores							
Rotating Outer Ring Load	Easy axial displacement of inner ring on shaft desirable.	Wheels on Stationary Axles	All Shaft Diameters			g6	Use g5 and h5 where accuracy is required. In case of large bearings, f6 can be used to allow easy axial movement.
	Easy axial displacement of inner ring on shaft unnecessary	Tension Pulleys Rope Sheaves				h6	
Rotating Inner Ring Load or Direction of Load Indeterminate	Light Loads or Variable Loads (<0.06C _r (¹))	Electrical Home Appliances Pumps, Blowers, Transport Vehicles, Precision Machinery, Machine Tools	<18	—	—	js5	k6 and m6 can be used for single-row tapered roller bearings and single-row angular contact ball bearings instead of k5 and m5. More than CN bearing internal clearance is necessary.
			18 to 100	<40	—	js6 (j6)	
			100 to 200	40 to 140	—	k6	
	Normal Loads (0.06 to 0.13C _r (¹))	General Bearing Applications, Medium and Large Motors(²), Turbines, Pumps, Engine Main Bearings, Gears, Woodworking Machines	<18	—	—	js5 or js6 (j5 or j6)	
			18 to 100	<40	<40	k5 or k6	
			100 to 140	40 to 100	40 to 65	m5 or m6	
			140 to 200	100 to 140	65 to 100	m6	
	Heavy Loads or Shock Loads (>0.13C _r (¹))	Railway Axleboxes, Industrial Vehicles, Traction Motors, Construction Equipment, Crushers	200 to 280	140 to 200	100 to 140	n6	
			—	200 to 400	140 to 280	p6	
			—	—	280 to 500	r6	
Axial Loads Only		—	50 to 140	50 to 100	n6		
		—	140 to 200	100 to 140	p6		
		—	over 200	140 to 200	r6		
—	—	200 to 500	r7				
Radial Bearings with Tapered Bores and Sleeves							
All Types of Loading	General bearing Applications, Railway Axleboxes, Transmission Shafts, Woodworking Spindles	All Shaft Diameters			h9/IT5(²)	IT5 and IT7 mean that the deviation of the shaft from its true geometric form, e. g. roundness and cylindricity should be within the tolerances of IT5 and IT7 respectively.	
					h10/IT7(²)		

- Notes** (1) C_r represents the basic load rating of the bearing.
 (2) Refer to Appendix Table 11 on page C22 for the values of standard tolerance grades IT.
 (3) Refer to Tables 9.13.1 and 9.13.2 for the recommended fits of shafts used in electric motors for deep groove ball bearings with bore diameters ranging from 10 mm to 160 mm, and for cylindrical roller bearings with bore diameters ranging from 24 mm to 200 mm.
- Remarks** This table is applicable only to solid steel shafts.

Table 9.3 Fits of Thrust Bearings with Shafts

Load Conditions		Examples	Shaft Diameter (mm)	Tolerance of Shaft	Remarks
Central Axial Load Only		Main Shafts of Lathes	All Shaft Diameters	h6 or js6 (j6)	—
Combined Radial and Axial Loads (Spherical Thrust Roller Bearings)	Stationary Inner Ring Load	Cone Crushers	All Shaft Diameters	js6 (j6)	
	Rotating Inner Ring Load or Direction of Load Indeterminate	Paper Pulp Refiners, Plastic Extruders	<200	k6	
			200 to 400	m6	
		over 400	n6		

Table 9.4 Fits of Radial Bearings with Housings

Load Conditions		Examples	Tolerances for Housing Bores	Axial Displacement of Outer Ring	Remarks	
Solid Housings	Rotating Outer Ring Load	Heavy Loads on Bearing in Thin-Walled Housing or Heavy Shock Loads	P7	Impossible	—	
		Normal or Heavy Loads	N7			
		Light or Variable Loads	M7			
Solid or Split Housings	Direction of Load Indeterminate	Heavy Shock Loads		Generally Impossible	If axial displacement of the outer ring is not required.	
		Normal or Heavy Loads	K7			
Solid Housing	Rotating Inner Ring Load	Normal or Light Loads	JS7 (J7)	Possible	Axial displacement of outer ring is necessary.	
		High Temperature Rise of Inner Ring Through Shaft				
	Direction of Load Indeterminate	Loads of All kinds	General Bearing Applications, Railway Axleboxes	H7	Easily possible	—
		Normal or Light Loads	Plummer Blocks	H8		
		Accurate Running Desirable under Normal or Light Loads	G7			
		Grinding Spindle Rear Ball Bearings, High Speed Centrifugal Compressor Free Bearings	JS6 (J6)	Possible	—	
		Grinding Spindle Front Ball Bearings, High Speed Centrifugal Compressor Fixed Bearings	K6	Generally Impossible	For heavy loads, interference fit tighter than K is used. When high accuracy is required, very strict tolerances should be used for fitting.	
	Rotating Inner Ring Load	Accurate Running and High Rigidity Desirable under Variable Loads	M6 or N6	Impossible		
		Minimum noise is required.	H6	Easily Possible	—	

- Note** (1) Refer to Tables 9.13.1 and 9.13.2 for the recommended fits of housing bores of deep groove ball bearings and cylindrical roller bearings for electric motors.
- Remarks** 1. This table is applicable to cast iron and steel housings. For housings made of light alloys, the interference should be tighter than those in this table.
 2. Refer to the introductory section of the bearing dimension tables (blue pages) for special fits such as drawn cup needle roller bearings.

Table 9.5 Fits of Thrust Bearings with Housings

Load Conditions		Bearing Types	Tolerances for Housing Bores	Remarks
Axial Loads Only		Thrust Ball Bearings	Clearance over 0.25mm	For General Applications
			H8	When precision is required
Combined Radial and Axial Loads		Spherical Thrust Roller Bearings Steep Angle Tapered Roller Bearings	Outer ring has radial clearance.	When radial loads are sustained by other bearings.
Stationary Outer Ring Loads	Rotating Outer Ring Loads or Direction of Load Indeterminate	Spherical Thrust Roller Bearings	H7 or JS7 (J7)	—
			K7	Normal Loads
			M7	Relatively Heavy Radial Loads

Table 9.6 Fits of Inch Design Tapered Roller Bearings with Shafts

(1) Bearings of Precision Classes 4 and 2

Units : μm

Operating Conditions		Nominal Bore Diameters d				Bore Diameter Tolerances Δd_s		Shaft Diameter Tolerances		Remarks
		over		incl.		high	low	high	low	
		(mm)	1/25.4	(mm)	1/25.4					
Rotating Inner Ring Loads	Normal Loads	—		76.200	3.0000	+13	0	+38	+25	For bearings with $d \leq 152.4$ mm, clearance is usually larger than CN. In general, bearings with a clearance larger than CN are used. ※ means that the average interference is about 0.0005 d .
		76.200	3.0000	304.800	12.0000	+25	0	+64	+38	
		304.800	12.0000	609.600	24.0000	+51	0	+127	+76	
	609.600	24.0000	914.400	36.0000	+76	0	+190	+114		
	Heavy Loads Shock Loads High Speeds	—		76.200	3.0000	+13	0	+64	+38	
		76.200	3.0000	304.800	12.0000	+25	0	※	※	
304.800		12.0000	609.600	24.0000	+51	0	※	※		
609.600	24.0000	914.400	36.0000	+76	0	+381	+305			
Rotating Outer Ring Loads	Normal Loads without Shocks	—		76.200	3.0000	+13	0	+13	0	The inner ring cannot be displaced axially. When heavy or shock loads exist, the figures in the above (Rotating inner ring loads, heavy or shock loads) apply.
		76.200	3.0000	304.800	12.0000	+25	0	+25	0	
		304.800	12.0000	609.600	24.0000	+51	0	+51	0	
	609.600	24.0000	914.400	36.0000	+76	0	+76	0		
	The inner ring can be displaced axially.	—		76.200	3.0000	+13	0	0	-13	
		76.200	3.0000	304.800	12.0000	+25	0	0	-25	
304.800		12.0000	609.600	24.0000	+51	0	0	-51		
609.600	24.0000	914.400	36.0000	+76	0	0	-76			

(2) Bearings of Precision Classes 3 and 0 (1)

Units : μm

Operating Conditions		Nominal Bore Diameters d				Bore Diameter Tolerances Δd_s		Shaft Diameter Tolerances		Remarks
		over		incl.		high	low	high	low	
		(mm)	1/25.4	(mm)	1/25.4					
Rotating Inner Ring Loads	Precision Machine-Tool Main Spindles	—		76.200	3.0000	+13	0	+30	+18	—
		76.200	3.0000	304.800	12.0000	+13	0	+30	+18	
		304.800	12.0000	609.600	24.0000	+25	0	+64	+38	
	609.600	24.0000	914.400	36.0000	+38	0	+102	+64		
	Heavy Loads Shock Loads High Speeds	—		76.200	3.0000	+13	0	—	—	
		76.200	3.0000	304.800	12.0000	+13	0	—	—	
304.800		12.0000	609.600	24.0000	+25	0	—	—		
609.600	24.0000	914.400	36.0000	+38	0	—	—			
Rotating Outer Ring Loads	Precision Machine-Tool Main Spindles	—		76.200	3.0000	+13	0	+30	+18	—
		76.200	3.0000	304.800	12.0000	+13	0	+30	+18	
		304.800	12.0000	609.600	24.0000	+25	0	+64	+38	
	609.600	24.0000	914.400	36.0000	+38	0	+102	+64		

Note (1) For bearings with d greater than 304.8 mm, Class 0 does not exist.

Table 9.7 Fits of Inch Design Tapered Roller Bearings with Housings

(1) Bearings of Precision Classes 4 and 2

Units : μm

Operating Conditions		Nominal Outside Diameters D				Outside Diameter Tolerances ΔD_s		Housing Bore Diameter Tolerances		Remarks
		over		incl.		high	low	high	low	
		(mm)	1/25.4	(mm)	1/25.4					
Rotating Inner Ring Loads	Used either on free-end or fixed-end	—		76.200	3.0000	+25	0	+76	+51	The outer ring can be easily displaced axially.
		76.200	3.0000	127.000	5.0000	+25	0	+76	+51	
		127.000	5.0000	304.800	12.0000	+25	0	+76	+51	
	304.800	12.0000	609.600	24.0000	+51	0	+152	+102		
	609.600	24.0000	914.400	36.0000	+76	0	+229	+152		
	The outer ring position can be adjusted axially.	—		76.200	3.0000	+25	0	+25	0	
76.200		3.0000	127.000	5.0000	+25	0	+25	0		
127.000		5.0000	304.800	12.0000	+25	0	+51	0		
304.800	12.0000	609.600	24.0000	+51	0	+76	+25			
609.600	24.0000	914.400	36.0000	+76	0	+127	+51			
Rotating Outer Ring Loads	Normal Loads The outer ring position cannot be adjusted axially.	—		76.200	3.0000	+25	0	-13	-38	Generally, the outer ring is fixed axially.
		76.200	3.0000	127.000	5.0000	+25	0	-25	-51	
		127.000	5.0000	304.800	12.0000	+25	0	-25	-51	
	304.800	12.0000	609.600	24.0000	+51	0	-25	-76		
	609.600	24.0000	914.400	36.0000	+76	0	-25	-102		
	The outer ring position cannot be adjusted axially.	—		76.200	3.0000	+25	0	-13	-38	
76.200		3.0000	127.000	5.0000	+25	0	-25	-51		
127.000		5.0000	304.800	12.0000	+25	0	-25	-51		
304.800	12.0000	609.600	24.0000	+51	0	-25	-76			
609.600	24.0000	914.400	36.0000	+76	0	-25	-102			

(2) Bearings of Precision Classes 3 and 0 (1)

Units : μm

Operating Conditions		Nominal Outside Diameters D				Outside Diameter Tolerances ΔD_s		Housing Bore Diameter Tolerances		Remarks
		over		incl.		high	low	high	low	
		(mm)	1/25.4	(mm)	1/25.4					
Rotating Inner Ring Loads	Used on free-end	—		152.400	6.0000	+13	0	+38	+25	The outer ring can be easily displaced axially.
		152.400	6.0000	304.800	12.0000	+13	0	+38	+25	
		304.800	12.0000	609.600	24.0000	+25	0	+64	+38	
	609.600	24.0000	914.400	36.0000	+38	0	+89	+51		
	Used on fixed-end	—		152.400	6.0000	+13	0	+25	+13	
		152.400	6.0000	304.800	12.0000	+13	0	+25	+13	
304.800		12.0000	609.600	24.0000	+25	0	+51	+25		
609.600	24.0000	914.400	36.0000	+38	0	+76	+38			
Rotating Outer Ring Loads	The outer ring position can be adjusted axially.	—		152.400	6.0000	+13	0	+13	0	Generally, the outer ring is fixed axially.
		152.400	6.0000	304.800	12.0000	+13	0	+25	0	
		304.800	12.0000	609.600	24.0000	+25	0	+25	0	
	609.600	24.0000	914.400	36.0000	+38	0	+38	0		
	The outer ring position cannot be adjusted axially.	—		152.400	6.0000	+13	0	0	-13	
		152.400	6.0000	304.800	12.0000	+13	0	0	-25	
304.800		12.0000	609.600	24.0000	+25	0	0	-25		
609.600	24.0000	914.400	36.0000	+38	0	0	-38			
Rotating Outer Ring Loads	Normal Loads The outer ring position cannot be adjusted axially.	—		76.200	3.0000	+13	0	-13	-25	The outer ring is fixed axially.
		76.200	3.0000	152.400	6.0000	+13	0	-13	-25	
		152.400	6.0000	304.800	12.0000	+13	0	-13	-38	
	304.800	12.0000	609.600	24.0000	+25	0	-13	-38		
	609.600	24.0000	914.400	36.0000	+38	0	-13	-51		
	The outer ring position cannot be adjusted axially.	—		76.200	3.0000	+13	0	-13	-25	
76.200		3.0000	152.400	6.0000	+13	0	-13	-25		
152.400		6.0000	304.800	12.0000	+13	0	-13	-38		
304.800	12.0000	609.600	24.0000	+25	0	-13	-38			
609.600	24.0000	914.400	36.0000	+38	0	-13	-51			

Note (1) For bearings with D greater than 304.8 mm, Class 0 does not exist.

9.2 Bearing Internal Clearances

9.2.1 Internal Clearances and Their Standards

The internal clearance in rolling bearings in operation greatly influences bearing performance including fatigue life, vibration, noise, heat-generation, etc. Consequently, the selection of the proper internal clearance is one of the most important tasks when choosing a bearing after the type and size have been determined.

This bearing internal clearance is the combined clearances between the inner/outer rings and rolling elements. The radial and axial clearances are defined as the total amount that one ring can be displaced relative to the other in the radial and axial directions respectively (Fig. 9.1).

To obtain accurate measurements, the clearance is generally measured by applying a specified measuring load on the bearing; therefore, the measured clearance (sometimes called "measured clearance" to make a distinction) is always slightly larger than the theoretical internal clearance (called "geometrical clearance" for radial bearings) by the amount of elastic deformation caused by the measuring load.

Therefore, the theoretical internal clearance may be obtained by correcting the measured clearance by the amount of elastic deformation. However, in the case of roller bearings this elastic deformation is negligibly small.

Usually the clearance before mounting is the one specified as the theoretical internal clearance.

In Table 9.8, reference table and page numbers are listed by bearing types.

Table 9.8 Index for Radial Internal Clearances by Bearing Types

Bearing Types		Table Number	Page Number
Deep Groove Ball Bearings		9.9	A89
Extra Small and Miniature Ball Bearings		9.10	A89
Magneto Bearings		9.11	A89
Self-Aligning Ball Bearings		9.12	A90
Deep Groove Ball Bearings	For Motors	9.13.1	A90
Cylindrical Roller Bearings		9.13.2	A90
Cylindrical Roller Bearings	With Cylindrical Bores	9.14	A91
	With Cylindrical Bores (Matched)		
	With Tapered Bores (Matched)		
Spherical Roller Bearings	With Cylindrical Bores	9.15	A92
	With Tapered Bores		
Double-Row and Combined Tapered Roller Bearings		9.15	A93
Combined Angular Contact Ball Bearings (1)		9.17	A94
Four-Point Contact Ball Bearings (1)		9.18	A94

Note (1) Values given are axial clearances.

Table 9.9 Radial Internal Clearances in Deep Groove Ball Bearings

Nominal Bore Diameter <i>d</i> (mm)		Clearance					Units : μm				
		C2		CN		C3		C4		C5	
over	incl.	min.	max.	min.	max.	min.	max.	min.	max.	min.	max.
10 only		0	7	2	13	8	23	14	29	20	37
10	18	0	9	3	18	11	25	18	33	25	45
18	24	0	10	5	20	13	28	20	36	28	48
24	30	1	11	5	20	13	28	23	41	30	53
30	40	1	11	6	20	15	33	28	46	40	64
40	50	1	11	6	23	18	36	30	51	45	73
50	65	1	15	8	28	23	43	38	61	55	90
65	80	1	15	10	30	25	51	46	71	65	105
80	100	1	18	12	36	30	58	53	84	75	120
100	120	2	20	15	41	36	66	61	97	90	140
120	140	2	23	18	48	41	81	71	114	105	160
140	160	2	23	18	53	46	91	81	130	120	180
160	180	2	25	20	61	53	102	91	147	135	200
180	200	2	30	25	71	63	117	107	163	150	230
200	225	2	35	25	85	75	140	125	195	175	265
225	250	2	40	30	95	85	160	145	225	205	300
250	280	2	45	35	105	90	170	155	245	225	340
280	315	2	55	40	115	100	190	175	270	245	370
315	355	3	60	45	125	110	210	195	300	275	410
355	400	3	70	55	145	130	240	225	340	315	460
400	450	3	80	60	170	150	270	250	380	350	510
450	500	3	90	70	190	170	300	280	420	390	570
500	560	10	100	80	210	190	330	310	470	440	630
560	630	10	110	90	230	210	360	340	520	490	690
630	710	20	130	110	260	240	400	380	570	540	760
710	800	20	140	120	290	270	450	430	630	600	840

Remarks To obtain the measured values, use the clearance correction for radial clearance increase caused by the measuring load in the table below. For the C2 clearance class, the smaller value should be used for bearings with minimum clearance and the larger value for bearings near the maximum clearance range.

Nominal Bore Dia. <i>d</i> (mm)		Measuring Load (N) {kgf}		Radial Clearance Correction Amount					Units : μm	
				C2	CN	C3	C4	C5		
over	incl.									
10 (incl)	18	24.5	{2.5}	3 to 4	4	4	4	4	4	4
18	50	49	{5}	4 to 5	5	6	6	6	6	6
50	280	147	{15}	6 to 8	8	9	9	9	9	9

Remarks For values exceeding 280 mm, please contact NSK.

Table 9.10 Radial Internal Clearances in Extra Small and Miniature Ball Bearings

Clearance Symbol	Units : μm					
	MC1	MC2	MC3	MC4	MC5	MC6
Clearance	min. max.	min. max.	min. max.	min. max.	min. max.	min. max.
	0 5	3 8	5 10	8 13	13 20	20 28

Remarks 1. The standard clearance is MC3.
2. To obtain the measured value, add correction amount in the table below.

Clearance Symbol	Units : μm					
	MC1	MC2	MC3	MC4	MC5	MC6
Clearance Correction Value	1	1	1	1	2	2

The measuring loads are as follows :

- For miniature ball bearings* 2.5N {0.25kgf}
- For extra small ball bearings* 4.4N {0.45kgf}

*For their classification, refer to Table 1 on Page B 31.

Table 9.11 Radial Internal Clearances in Magneto Bearings

Nominal Bore Diameter <i>d</i> (mm)		Bearing Series	Clearance		Units : μm	
			min.	max.		
over	incl.					
2.5	30	EN	10	50		
		E	30	60		

Table 9.12 Radial Internal Clearances in Self-Aligning Ball Bearings

Units : μm

Nominal Bore Dia. <i>d</i> (mm)		Clearance in Bearings with Cylindrical Bores					Clearance in Bearings with Tapered Bores								
		C2		CN		C3	C4		C5		C2	CN	C3	C4	C5
over	incl.	min.	max.	min.	max.	min.	max.	min.	max.	min.	max.	min.	max.	min.	max.
2.5	6	1	8	5	15	10	20	15	25	21	33	—	—	—	—
6	10	2	9	6	17	12	25	19	33	27	42	—	—	—	—
10	14	2	10	6	19	13	26	21	35	30	48	—	—	—	—
14	18	3	12	8	21	15	28	23	37	32	50	—	—	—	—
18	24	4	14	10	23	17	30	25	39	34	52	7	17	13	26
24	30	5	16	11	24	19	35	29	46	40	58	9	20	15	28
30	40	6	18	13	29	23	40	34	53	46	66	12	24	19	35
40	50	6	19	14	31	25	44	37	57	50	71	14	27	22	39
50	65	7	21	16	36	30	50	45	69	62	88	18	32	27	47
65	80	8	24	18	40	35	60	54	83	76	108	23	39	35	57
80	100	9	27	22	48	42	70	64	96	89	124	29	47	42	68
100	120	10	31	25	56	50	83	75	114	105	145	35	56	50	81
120	140	10	38	30	68	60	100	90	135	125	175	40	68	60	98
140	160	15	44	35	80	70	120	110	161	150	210	45	74	65	110

Table 9.13 Radial Internal Clearances in Bearings for Electric Motors

Table 9.13.1 Deep Groove Ball Bearings for Electric Motors

Units : μm

Nominal Bore Dia. <i>d</i> (mm)		Clearance		Remarks	
		CM		Recommended fit	
over	incl.	min.	max.	Shaft	Housing Bore
10 (incl)	18	4	11	js5 (j5)	H6, H7 ⁽¹⁾ or JS6, JS7 (J6, J7) ⁽²⁾
18	30	5	12	k5	
30	50	9	17		
50	80	12	22		
80	100	18	30	m5	
100	120	18	30		
120	160	24	38		

Notes ⁽¹⁾ Applicable to outer rings that require movement in the axial direction.

⁽²⁾ Applicable to outer rings that do not require movement in the axial direction.

Remarks The radial clearance increase caused by the measuring load is equal to the correction amount for CN clearance in the remarks under Table 9.9.

Table 9.13.2 Cylindrical Roller Bearings for Electric Motors

Units : μm

Nominal Bore Dia. <i>d</i> (mm)		Clearance				Remarks	
		Interchangeable CT		Non-Interchangeable CM		Recommended Fit	
over	incl.	min.	max.	min.	max.	Shaft	Housing Bore
24	40	15	35	15	30	k5	JS6, JS7 (J6, J7) ⁽¹⁾ or K6, K7 ⁽²⁾
40	50	20	40	20	35	m5	
50	65	25	45	25	40		
65	80	30	50	30	45		
80	100	35	60	35	55		
100	120	35	65	35	60		
120	140	40	70	40	65		
140	160	50	85	50	80		
160	180	60	95	60	90		
180	200	65	105	65	100		

Notes ⁽¹⁾ Applicable to outer rings that require movement in the axial direction.

⁽²⁾ Applicable to outer rings that do not require movement in the axial direction.

Table 9.14 Radial Internal Clearances in Cylindrical Roller Bearings and Solid-Type Needle Roller Bearings

Units : μm

Nominal Bore Dia. <i>d</i> (mm)		Clearances in Bearings with Cylindrical Bores					Clearances in Non-Interchangeable Bearings with Cylindrical Bores										
		C2		CN		C3	C4		C5		CC1	CC2	CC ⁽¹⁾	CC3	CC4	CC5	
over	incl.	min.	max.	min.	max.	min.	max.	min.	max.	min.	max.	min.	max.	min.	max.	min.	max.
—	10	0	25	20	45	35	60	50	75	—	—	—	—	—	—	—	—
10	24	0	25	20	45	35	60	50	75	65	90	5	15	10	20	20	30
24	30	0	25	20	45	35	60	50	75	70	95	5	15	10	25	25	35
30	40	5	30	25	50	45	70	60	85	80	105	5	15	12	25	25	40
40	50	5	35	30	60	50	80	70	100	95	125	5	18	15	30	30	45
50	65	10	40	40	70	60	90	80	110	110	140	5	20	15	35	35	50
65	80	10	45	40	75	65	100	90	125	130	165	10	25	20	40	40	60
80	100	15	50	50	85	75	110	105	140	155	190	10	30	25	45	45	70
100	120	15	55	50	90	85	125	125	165	180	220	10	30	25	50	50	80
120	140	15	60	60	105	100	145	145	190	200	245	10	35	30	60	60	90
140	160	20	70	70	120	115	165	165	215	225	275	10	35	35	65	65	100
160	180	25	75	75	125	120	170	170	220	250	300	10	40	35	75	75	110
180	200	35	90	90	145	140	195	195	250	275	330	15	45	40	80	80	120
200	225	45	105	105	165	160	220	220	280	305	365	15	50	45	90	90	135
225	250	45	110	110	175	170	235	235	300	330	395	15	50	50	100	100	150
250	280	55	125	125	195	190	260	260	330	370	440	20	55	55	110	110	165
280	315	55	130	130	205	200	275	275	350	410	485	20	60	60	120	120	180
315	355	65	145	145	225	225	305	305	385	455	535	20	65	65	135	135	200
355	400	100	190	190	280	280	370	370	460	510	600	25	75	75	150	150	225
400	450	110	210	210	310	310	410	410	510	565	665	25	85	85	170	170	255
450	500	110	220	220	330	330	440	440	550	625	735	25	95	95	190	190	285

Note ⁽¹⁾ CC denotes normal clearance for non-Interchangeable cylindrical roller bearings and solid-type needle roller bearings.

Units : μm

Nominal Bore Dia. <i>d</i> (mm)		Clearances in Non-Interchangeable Bearings with Tapered Bores															
		CC9 ⁽¹⁾		CC0		CC1		CC2		CC ⁽²⁾		CC3		CC4		CC5	
over	incl.	min.	max.	min.	max.	min.	max.	min.	max.	min.	max.	min.	max.	min.	max.	min.	max.
10	24	5	10	—	—	10	20	20	30	35	45	45	55	55	65	75	85
24	30	5	10	8	15	10	25	25	35	40	50	50	60	60	70	80	95
30	40	5	12	8	15	12	25	25	40	45	55	55	70	70	80	95	110
40	50	5	15	10	20	15	30	30	45	50	65	65	80	80	95	110	125
50	65	5	15	10	20	15	35	35	50	55	75	75	90	90	110	130	150
65	80	10	20	15	30	20	40	40	60	70	90	90	110	110	130	150	170
80	100	10	25	20	35	25	45	45	70	80	105	105	125	125	150	180	205
100	120	10	25	20	35	25	50	50	80	95	120	120	145	145	170	205	230
120	140	15	30	25	40	30	60	60	90	105	135	135	160	160	190	230	260
140	160	15	35	30	50	35	65	65	100	115	150	150	180	180	215	260	295
160	180	15	35	30	50	35	75	75	110	125	165	165	200	200	240	285	320
180	200	20	40	30	50	40	80	80	120	140	180	180	220	220	260	315	355
200	225	20	45	35	60	45	90	90	135	155	200	200	240	240	285	350	395
225	250	25	50	40	65	50	100	100	150	170	215	215	265	265	315	380	430
250	280	25	55	40	70	55	110	110	165	185	240	240	295	295	350	420	475
280	315	30	60	—	—	60	120	120	180	205	265	265	325	325	385	470	530
315	355	30	65	—	—	65	135	135	200	225	295	295	360	360	430	520	585
355	400	35	75	—	—	75	150	150	225	255	330	330	405	405	480	585	660
400	450	40	85	—	—	85	170	170	255	285	370	370	455	455	540	650	735
450	500	45	95	—	—	95	190	190	285	315	410	410	505	505	600	720	815

Notes ⁽¹⁾ Clearance CC9 is applicable to cylindrical roller bearings with tapered bores in ISO Tolerance Classes 5 and 4.

⁽²⁾ CC denotes normal clearance for non-Interchangeable cylindrical roller bearings and solid-type needle roller bearings.

Table 9.15 Radial Internal Clearances in Spherical Roller Bearings

Units : μm

Nominal Bore Dia. <i>d</i> (mm)		Clearance in Bearings with Cylindrical Bores										Clearance in Bearings with Tapered Bores									
		C2		CN		C3		C4		C5		C2		CN		C3		C4		C5	
over	incl.	min.	max.	min.	max.	min.	max.	min.	max.	min.	max.	min.	max.	min.	max.	min.	max.	min.	max.	min.	max.
24	30	15	25	25	40	40	55	55	75	75	95	20	30	30	40	40	55	55	75	75	95
30	40	15	30	30	45	45	60	60	80	80	100	25	35	35	50	50	65	65	85	85	105
40	50	20	35	35	55	55	75	75	100	100	125	30	45	45	60	60	80	80	100	100	130
50	65	20	40	40	65	65	90	90	120	120	150	40	55	55	75	75	95	95	120	120	160
65	80	30	50	50	80	80	110	110	145	145	180	50	70	70	95	95	120	120	150	150	200
80	100	35	60	60	100	100	135	135	180	180	225	55	80	80	110	110	140	140	180	180	230
100	120	40	75	75	120	120	160	160	210	210	260	65	100	100	135	135	170	170	220	220	280
120	140	50	95	95	145	145	190	190	240	240	300	80	120	120	160	160	200	200	260	260	330
140	160	60	110	110	170	170	220	220	280	280	350	90	130	130	180	180	230	230	300	300	380
160	180	65	120	120	180	180	240	240	310	310	390	100	140	140	200	200	260	260	340	340	430
180	200	70	130	130	200	200	260	260	340	340	430	110	160	160	220	220	290	290	370	370	470
200	225	80	140	140	220	220	290	290	380	380	470	120	180	180	250	250	320	320	410	410	520
225	250	90	150	150	240	240	320	320	420	420	520	140	200	200	270	270	350	350	450	450	570
250	280	100	170	170	260	260	350	350	460	460	570	150	220	220	300	300	390	390	490	490	620
280	315	110	190	190	280	280	370	370	500	500	630	170	240	240	330	330	430	430	540	540	680
315	355	120	200	200	310	310	410	410	550	550	690	190	270	270	360	360	470	470	590	590	740
355	400	130	220	220	340	340	450	450	600	600	750	210	300	300	400	400	520	520	650	650	820
400	450	140	240	240	370	370	500	500	660	660	820	230	330	330	440	440	570	570	720	720	910
450	500	140	260	260	410	410	550	550	720	720	900	260	370	370	490	490	630	630	790	790	1000
500	560	150	280	280	440	440	600	600	780	780	1000	290	410	410	540	540	680	680	870	870	1100
560	630	170	310	310	480	480	650	650	850	850	1100	320	460	460	600	600	760	760	980	980	1230
630	710	190	350	350	530	530	700	700	920	920	1190	350	510	510	670	670	850	850	1090	1090	1360
710	800	210	390	390	580	580	770	770	1010	1010	1300	390	570	570	750	750	960	960	1220	1220	1500
800	900	230	430	430	650	650	860	860	1120	1120	1440	440	640	640	840	840	1070	1070	1370	1370	1690
900	1000	260	480	480	710	710	930	930	1220	1220	1570	490	710	710	930	930	1190	1190	1520	1520	1860
1000	1120	290	530	530	780	780	1020	1020	1330	1330	1700	530	770	770	1030	1030	1300	1300	1670	1670	—
1120	1250	320	580	580	860	860	1120	1120	1460	1460	1850	570	830	830	1120	1120	1420	1420	1830	1830	—
1250	1400	350	640	640	950	950	1240	1240	1620	1620	2050	620	910	910	1230	1230	1560	1560	2000	2000	—

Table 9.16 Radial Internal Clearances in Double-Row and Combined Tapered Roller Bearings

Units : μm

Nominal Bore Dia. <i>d</i> (mm)		Clearance													
		C1		C2		CN		C3		C4		C5			
over	incl.	min.	max.	min.	max.	min.	max.	min.	max.	min.	max.	min.	max.	min.	max.
—	18	0	10	10	20	20	30	35	45	50	60	65	75	—	—
18	24	0	10	10	20	20	30	35	45	50	60	65	75	—	—
24	30	0	10	10	20	20	30	40	50	50	60	70	80	—	—
30	40	0	12	12	25	25	40	45	60	60	75	80	95	—	—
40	50	0	15	15	30	30	45	50	65	65	80	95	110	—	—
50	65	0	15	15	35	35	55	60	80	80	100	110	130	—	—
65	80	0	20	20	40	40	60	70	90	90	110	130	150	—	—
80	100	0	25	25	50	50	75	80	105	105	130	155	180	—	—
100	120	5	30	30	55	55	80	90	115	120	145	180	210	—	—
120	140	5	35	35	65	65	95	100	130	135	165	200	230	—	—
140	160	10	40	40	70	70	100	110	140	150	180	220	260	—	—
160	180	10	45	45	80	80	115	125	160	165	200	250	290	—	—
180	200	10	50	50	90	90	130	140	180	180	220	280	320	—	—
200	225	20	60	60	100	100	140	150	190	200	240	300	340	—	—
225	250	20	65	65	110	110	155	165	210	220	270	330	380	—	—
250	280	20	70	70	120	120	170	180	230	240	290	370	420	—	—
280	315	30	80	80	130	130	180	190	240	260	310	410	460	—	—
315	355	30	80	80	130	140	190	210	260	290	350	450	510	—	—
355	400	40	90	90	140	150	200	220	280	330	390	510	570	—	—
400	450	45	95	95	145	170	220	250	310	370	430	560	620	—	—
450	500	50	100	100	150	190	240	280	340	410	470	620	680	—	—
500	560	60	110	110	160	210	260	310	380	450	520	700	770	—	—
560	630	70	120	120	170	230	290	350	420	500	570	780	850	—	—
630	710	80	130	130	180	260	310	390	470	560	640	870	950	—	—
710	800	90	140	150	200	290	340	430	510	630	710	980	1060	—	—
800	900	100	150	160	210	320	370	480	570	700	790	1100	1200	—	—
900	1000	120	170	180	230	360	410	540	630	780	870	1200	1300	—	—
1000	1120	130	190	200	260	400	460	600	700	—	—	—	—	—	—
1120	1250	150	210	220	280	450	510	670	770	—	—	—	—	—	—
1250	1400	170	240	250	320	500	570	750	870	—	—	—	—	—	—

Remarks Axial internal clearance $\Delta_a = \Delta_r \cot \alpha \approx \frac{1.5}{e} \Delta_r$
 where Δ_r : Radial internal clearance
 α : Contact angle
 e : Constant (Listed in bearing tables)

Table 9.17 Axial Internal Clearances in Combined Angular Contact Ball Bearings (Measured Clearance)

Units : μm

Nominal Bore Diameter, <i>d</i> (mm)		Axial Internal Clearance											
		Contact Angle 30°						Contact Angle 40°					
		CN		C3		C4		CN		C3	C4		
over	incl.	min.	max.	min.	max.	min.	max.	min.	max.	min.	max.		
—	10	9	29	29	49	49	69	6	26	26	46	46	66
10	18	10	30	30	50	50	70	7	27	27	47	47	67
18	24	19	39	39	59	59	79	13	33	33	53	53	73
24	30	20	40	40	60	60	80	14	34	34	54	54	74
30	40	26	46	46	66	66	86	19	39	39	59	59	79
40	50	29	49	49	69	69	89	21	41	41	61	61	81
50	65	35	60	60	85	85	110	25	50	50	75	75	100
65	80	38	63	63	88	88	115	27	52	52	77	77	100
80	100	49	74	74	99	99	125	35	60	60	85	85	110
100	120	72	97	97	120	120	145	52	77	77	100	100	125
120	140	85	115	115	145	145	175	63	93	93	125	125	155
140	160	90	120	120	150	150	180	66	96	96	125	125	155
160	180	95	125	125	155	155	185	68	98	98	130	130	160
180	200	110	140	140	170	170	200	80	110	110	140	140	170

Remarks This table is applicable to bearings in Tolerance Classes Normal and 6. For internal axial clearances in bearings in tolerance classes better than 5 and contact angles of 15° and 25°, it is advisable to consult NSK.

Table 9.18 Axial Internal Clearance in Four-Point Contact Ball Bearings (Measured Clearances)

Units : μm

Nominal Bore Dia. <i>d</i> (mm)		Axial Internal Clearance							
		C2		CN		C3		C4	
over	incl.	min.	max.	min.	max.	min.	max.	min.	max.
10	18	15	55	45	85	75	125	115	165
18	40	26	66	56	106	96	146	136	186
40	60	36	86	76	126	116	166	156	206
60	80	46	96	86	136	126	176	166	226
80	100	56	106	96	156	136	196	186	246
100	140	66	126	116	176	156	216	206	266
140	180	76	156	136	196	176	246	226	296
180	220	96	176	156	226	206	276	256	326
220	260	115	196	175	245	225	305	285	365
260	300	135	215	195	275	255	335	315	395
300	350	155	235	215	305	275	365	345	425
350	400	175	265	245	335	315	405	385	475
400	500	205	305	285	385	355	455	435	525

9.2.2 Selection of Bearing Internal Clearances

Among the bearing internal clearances listed in the tables, the CN Clearance is adequate for standard operating conditions. The clearance becomes progressively smaller from C2 to C1 and larger from C3 to C5.

Standard operating conditions are defined as those where the inner ring speed is less than approximately 50% of the limiting speed listed in the bearing tables, the load is less than normal ($P \leq 0.1C_r$), and the bearing is tight-fitted on the shaft.

As a measure to reduce bearing noise for electric motors, the radial clearance range is narrower than the normal class and the values are somewhat smaller for deep groove ball bearings and cylindrical roller bearings for electric motors. (Refer to Table 9.13.1 and 9.13.2)

Internal clearance varies with the fit and temperature differences in operation. The changes in radial clearance in a roller bearing are shown in Fig. 9.2.

(1) Decrease in Radial Clearance Caused by Fitting and Residual Clearance

When the inner ring or the outer ring is tight-fitted on a shaft or in a housing, a decrease in the radial internal clearance is caused by the expansion or contraction of the bearing rings. The decrease varies according to the bearing type and size and design of the shaft and housing. The amount of this decrease is approximately 70 to 90% of the interference (refer to Section 15.2, Fits (1), Pages A130 to A133). The internal clearance after subtracting this decrease from the theoretical internal clearance Δ_0 is called the residual clearance, Δ_f .

(2) Decrease in Radial Internal Clearance Caused by Temperature Differences between Inner and Outer Rings and Effective Clearance

The frictional heat generated during operation is conducted away through the shaft and housing. Since housings generally conduct heat better than shafts, the temperature of the inner ring and the rolling elements is usually higher than that of the outer ring by 5 to 10°C. If the shaft is heated or the housing is cooled, the difference in temperature between the inner and outer rings is greater. The radial clearance decreases due to the thermal expansion caused by the temperature difference between the inner and outer rings. The amount of this decrease can be calculated using the following equations:

$$\delta_{t1} \doteq \alpha \Delta_t D_e \dots \dots \dots (9.6)$$

where δ_{t1} : Decrease in radial clearance due to temperature difference between inner and outer rings (mm)

α : Coefficient of linear expansion of bearing steel $\doteq 12.5 \times 10^{-6}$ (1/°C)

Δ_t : Temperature difference between inner and outer rings (°C)

D_e : Outer ring raceway diameter (mm)

For ball bearings

$$D_e \doteq \frac{1}{5} (4D + d) \dots \dots \dots (9.7)$$

For roller bearings

$$D_e \doteq \frac{1}{4} (3D + d) \dots \dots \dots (9.8)$$

The clearance after subtracting this δ_{t1} from the residual clearance, Δ_f is called the effective clearance, Δ . Theoretically, the longest life of a bearing can be expected when the effective clearance is slightly negative. However, it is difficult to achieve such an ideal condition, and an excessive negative clearance will greatly shorten the bearing life. Therefore, a clearance of zero or a slightly positive amount, instead of a negative one, should be selected. When single-row angular contact ball bearings or tapered roller bearings are used facing each other, there should be a small effective clearance, unless a preload is required. When two cylindrical roller bearings with a rib on one side are used facing each other, it is necessary to provide adequate axial clearance to allow for shaft elongation during operation.

The radial clearances used in some specific applications are given in Table 9.19. Under special operating conditions, it is advisable to consult NSK.

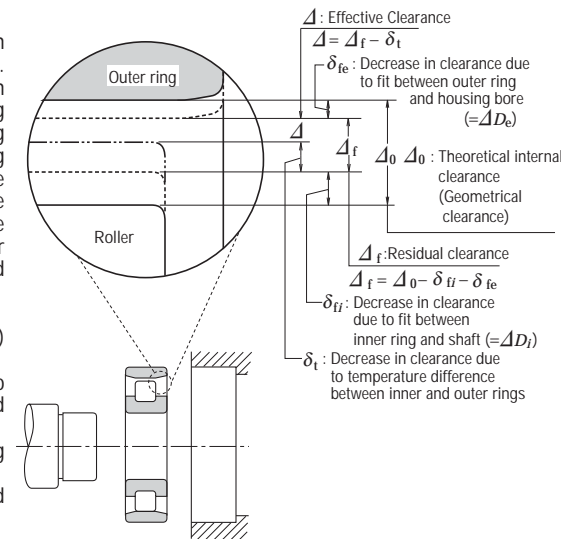

Fig. 9.2 Changes in Radial Internal Clearance of Bearings

Table 9.19 Examples of Clearances for Specific Applications

Operating Conditions	Examples	Internal Clearance
When shaft deflection is large.	Semi-floating rear wheels of automobiles	C5 or equivalent
When steam passes through hollow shafts or roller shafts are heated.	Dryers in paper making machines Table rollers for rolling mills	C3, C4 C3
When impact loads and vibration are severe or when both the inner and outer rings are tight-fitted.	Traction motors for railways Vibrating screens Fluid couplings Final reduction gears for tractors	C4 C3, C4 C4 C4
When both the inner and outer rings are loose-fitted	Rolling mill roll necks	C2 or equivalent
When noise and vibration restrictions are severe	Small motors with special specifications	C1, C2, CM
When clearance is adjusted after mounting to prevent shaft deflection, etc.	Main shafts of lathes	CC9, CC1

10. PRELOAD

Rolling bearings usually retain some internal clearance while in operation. In some cases, however, it is desirable to provide a negative clearance to keep them internally stressed. This is called "preloading". A preload is usually applied to bearings in which the clearance can be adjusted during mounting, such as angular contact ball bearings or tapered roller bearings. Usually, two bearings are mounted face-to-face or back-to-back to form a duplex set with a preload.

10.1 Purpose of Preload

The main purposes and some typical applications of preloaded bearings are as follows:

- (1) To maintain the bearings in exact position both radially and axially and to maintain the running accuracy of the shaft.
...Main shafts of machine tools, precision instruments, etc.
- (2) To increase bearing rigidity
...Main shafts of machine tools, pinion shafts of final drive gears of automobiles, etc.
- (3) To minimize noise due to axial vibration and resonance
...Small electric motors, etc.
- (4) To prevent sliding between the rolling elements and raceways due to gyroscopic moments
...High speed or high acceleration applications of angular contact ball bearings, and thrust ball bearings
- (5) To maintain the rolling elements in their proper position with the bearing rings
...Thrust ball bearings and spherical thrust roller bearings mounted on a horizontal shaft

10.2 Preloading Methods

10.2.1 Position Preload

A position preload is achieved by fixing two axially opposed bearings in such a way that a preload is imposed on them. Their position, once fixed, remain unchanged while in operation.

In practice, the following three methods are generally used to obtain a position preload.

- (1) By installing a duplex bearing set with previously adjusted stand-out dimensions (see Page A7, Fig. 1.1) and axial clearance.
- (2) By using a spacer or shim of proper size to obtain the required spacing and preload. (Refer to Fig. 10.1)
- (3) By utilizing bolts or nuts to allow adjustment of the axial preload. In this case, the starting torque should be measured to verify the proper preload.

10.2.2 Constant-Pressure Preload

A constant pressure preload is achieved using a coil or leaf spring to impose a constant preload. Even if the relative position of the bearings changes during operation, the magnitude of the preload remains relatively constant (refer to Fig. 10.2)

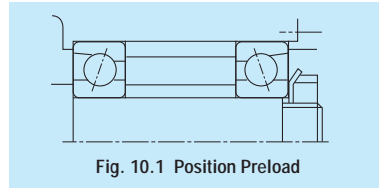

Fig. 10.1 Position Preload

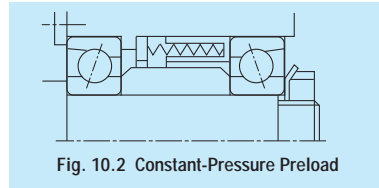

Fig. 10.2 Constant-Pressure Preload

10.3 Preload and Rigidity

10.3.1 Position Preload and Rigidity

When the inner rings of the duplex bearings shown in Fig.10.3 are fixed axially, bearings A and B are displaced δ_{a0} and axial space $2\delta_{a0}$ between the inner rings is eliminated. With this condition, a preload F_{a0} is imposed on each bearing. A preload diagram showing bearing rigidity, that is the relation between load and displacement with a given axial load F_a imposed on a duplex set, is shown in Fig. 10.4.

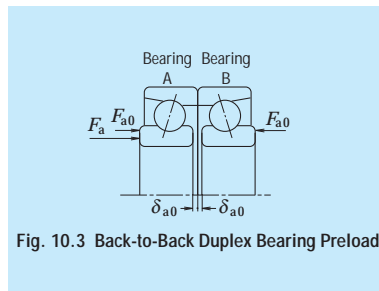

Fig. 10.3 Back-to-Back Duplex Bearing Preload

10.3.2 Constant-Pressure Preload and Rigidity

A preload diagram for duplex bearings under a constant-pressure preload is shown in Fig. 10.5. The deflection curve of the spring is nearly parallel to the horizontal axis because the rigidity of springs is lower than that of the bearing. As a result, the rigidity under a constant-pressure preload is approximately equal to that for a single bearing with a preload F_{a0} applied to it. Fig. 10.6 presents a comparison of the rigidity of a bearing with a position preload and one with a constant-pressure preload.

10.4 Selection of Preloading Method and Amount of Preload

10.4.1 Comparison of Preloading Methods

A comparison of the rigidity using both preloading methods is shown in Fig. 10.6. The position preload and constant-pressure preload may be compared as follows:

- (1) When both of the preloads are equal, the position preload provides greater bearing rigidity, in other words, the deflection due to external loads is less for bearings with a position preload.
- (2) In the case of a position preload, the preload varies depending on such factors as a difference in axial expansion due to a temperature difference between the shaft and housing, a difference in radial expansion due to a temperature difference between the inner and outer rings, deflection due to load, etc.

In the case of a constant-pressure preload, it is possible to minimize any change in the preload because the variation of the spring load with shaft expansion and contraction is negligible. From the foregoing explanation, it is seen that position preloads are generally preferred for increasing rigidity and constant-pressure preloads are more suitable for high speed applications, for prevention of axial vibration, for use with thrust bearings on horizontal shafts, etc.

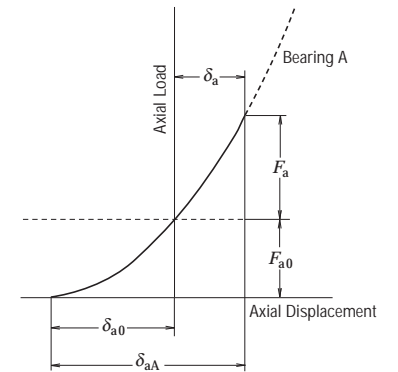
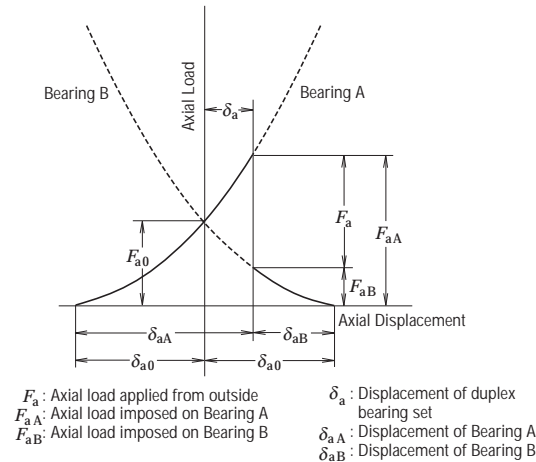

Fig. 10.5 Axial Displacement with Constant-Pressure Preload



F_a : Axial load applied from outside
 F_{aA} : Axial load imposed on Bearing A
 F_{aB} : Axial load imposed on Bearing B
 δ_a : Displacement of duplex bearing set
 δ_{aA} : Displacement of Bearing A
 δ_{aB} : Displacement of Bearing B

Fig. 10.4 Axial Displacement with Position Preload

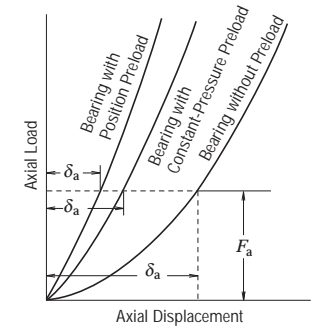

Fig. 10.6 Comparison of Rigidities and Preloading Methods

10.4.2 Amount of Preload

If the preload is larger than necessary, abnormal heat generation, increased frictional torque, reduced fatigue life, etc. may occur. The amount of the preload should be carefully determined considering the operating conditions and the purpose of the preload.

(1) Preloading of Duplex Angular Contact Ball Bearings

Average preloads for duplex angular contact ball bearings (contact angle of 15°) with precision better than P5 class, which are used on the main shafts of machine tools, are listed in Table 10.2.

The recommended fitting between the shaft and inner ring and between the housing and outer ring are listed in Table 10.1. In the case of fits with housings, the lower limit of the fitting range should be selected for fixed-end bearings and the upper limit for free-end bearings.

As a general rule, an extra light or light preload should be selected for grinding spindles and the main shafts of machining centers, while a medium preload should be adopted for the main shafts of lathes requiring rigidity.

When speeds result in a value of $D_{pw} \times n$ ($d_m n$ value) higher than 500000, the preload should be very carefully studied and selected. In such a case, please consult with NSK beforehand.

Table 10. 1 Recommended Fitting for High Accuracy Duplex Angular Contact Ball Bearings with Preload

Units : μm

Nominal Bore Dia. d (mm)		Target Shaft Interference	Nominal Outside Dia. D (mm)		Target Housing Clearance
over	incl.		over	incl.	
—	18	0 to 2	—	18	—
18	30	0 to 2.5	18	30	2 to 6
30	50	0 to 2.5	30	50	2 to 6
50	80	0 to 3	50	80	3 to 8
80	120	0 to 4	80	120	3 to 9
120	150	—	120	150	4 to 12
150	180	—	150	180	4 to 12
180	250	—	180	250	5 to 15

Table 10. 2 Preloads for Duplex

Units : N

Table 10. 2. 1 Duplex Bearings of Series 79

Bearing No.	Preloads			
	Extra light Preload EL	Light Preload L	Medium Preload M	Heavy Preload H
7900 C	7	15	29	59
7901 C	8.6	15	39	78
7902 C	12	25	49	100
7903 C	12	25	59	120
7904 C	19	39	78	150
7905 C	19	39	100	200
7906 C	24	49	100	200
7907 C	34	69	150	290
7908 C	39	78	200	390
7909 C	50	100	200	390
7910 C	50	100	250	490
7911 C	60	120	290	590
7912 C	60	120	290	590
7913 C	75	150	340	690
7914 C	100	200	490	980
7915 C	100	200	490	980
7916 C	100	200	490	980
7917 C	145	290	640	1 270
7918 C	145	290	740	1 470
7919 C	145	290	780	1 570
7920 C	195	390	880	1 770

Units : N

Table 10. 2. 2 Duplex

Bearing No.	Preloads	
	Extra light Preload EL	Light Preload L
7000 C	12	25
7001 C	12	25
7002 C	14	29
7003 C	14	29
7004 C	24	49
7005 C	29	59
7006 C	39	78
7007 C	60	120
7008 C	60	120
7009 C	75	150
7010 C	75	150
7011 C	100	200
7012 C	100	200
7013 C	125	250
7014 C	145	290
7015 C	145	290
7016 C	195	390
7017 C	195	390
7018 C	245	490
7019 C	270	540
7020 C	270	540

(2) Preload of Thrust Ball Bearings

When the balls in thrust ball bearings rotate at relatively high speeds, sliding due to gyroscopic moments on the balls may occur. The larger of the two values obtained from Equations(10.1) and (10.2) below should be adopted as the minimum axial load in order to prevent such sliding

$$F_{a \min} = \frac{C_{0a}}{100} \left(\frac{n}{N_{\max}} \right)^2 \dots\dots\dots (10.1)$$

$$F_{a \min} = \frac{C_{0a}}{1000} \dots\dots\dots (10.2)$$

where $F_{a \min}$: Minimum axial load (N), {kgf}
 n : Speed (min^{-1})
 C_{0a} : Basic static load rating (N), {kgf}
 N_{\max} : Limiting speed (oil lubrication) (min^{-1})

(3) Preload of Spherical Thrust Roller Bearings

When spherical thrust roller bearings are used, damage such as scoring may occur due to sliding between the rollers and outer ring raceway. The minimum axial load $F_{a \min}$ necessary to prevent such sliding is obtained from the following equation:

$$F_{a \min} = \frac{C_{0a}}{1000} \dots\dots\dots (10.3)$$

Angular Contact Ball Bearings

Units : N

Bearings of Series 70

Bearing No.	Preloads	
	Medium Preload M	Heavy Preload H
7000 C	49	100
7001 C	59	120
7002 C	69	150
7003 C	69	150
7004 C	120	250
7005 C	150	290
7006 C	200	390
7007 C	250	490
7008 C	290	590
7009 C	340	690
7010 C	390	780
7011 C	490	980
7012 C	540	1 080
7013 C	540	1 080
7014 C	740	1 470
7015 C	780	1 570
7016 C	930	1 860
7017 C	980	1 960
7018 C	1 180	2 350
7019 C	1 180	2 350
7020 C	1 270	2 550

Units : N

Table 10. 2. 3 Duplex Bearings of Series 72

Bearing No.	Preloads			
	Extra light Preload EL	Light Preload L	Medium Preload M	Heavy Preload H
7200 C	14	29	69	150
7201 C	19	39	100	200
7202 C	19	39	100	200
7203 C	24	49	150	290
7204 C	34	69	200	390
7205 C	39	78	200	390
7206 C	60	120	290	590
7207 C	75	150	390	780
7208 C	100	200	490	980
7209 C	125	250	540	1 080
7210 C	125	250	590	1 180
7211 C	145	290	780	1 570
7212 C	195	390	930	1 860
7213 C	220	440	1 080	2 160
7214 C	245	490	1 180	2 350
7215 C	270	540	1 230	2 450
7216 C	295	590	1 370	2 750
7217 C	345	690	1 670	3 330
7218 C	390	780	1 860	3 730
7219 C	440	880	2 060	4 120
7220 C	490	980	2 350	4 710

11. DESIGN OF SHAFTS AND HOUSINGS

11.1 Accuracy and Surface Finish of Shafts and Housings

If the accuracy of a shaft or housing does not meet the specification, the performance of the bearings will be affected and they will not provide their full capability. For example, inaccuracy in the squareness of the shaft shoulder may cause misalignment of the bearing inner and outer rings, which may reduce the bearing fatigue life by adding an edge load in addition to the normal load. Cage fracture and seizure sometimes occur for this same reason. Housings should be rigid in order to provide firm bearing support. High rigidity housings are advantageous also from the standpoint of noise, load distribution, etc.

For normal operating conditions, a turned finish or smooth bored finish is sufficient for the fitting surface; however, a ground finish is necessary for applications where vibration and noise must be low or where heavy loads are applied.

In cases where two or more bearings are mounted in one single-piece housing, the fitting surfaces of the housing bore should be designed so both bearing seats may be finished together with one operation such as in-line boring. In the case of split housings, care must be taken in the fabrication of the housing so the outer ring will not become deformed during installation. The accuracy and surface finish of shafts and housings are listed in Table 11.1 for normal operating conditions.

Table 11.1 Accuracy and Roughness of Shaft and Housing

Item	Class of Bearings	Shaft	Housing Bore
Tolerance for Out-of-roundness	Normal, Class 6	$\frac{IT3}{2}$ to $\frac{IT4}{2}$	$\frac{IT4}{2}$ to $\frac{IT5}{2}$
	Class 5, Class 4	$\frac{IT2}{2}$ to $\frac{IT3}{2}$	$\frac{IT2}{2}$ to $\frac{IT3}{2}$
Tolerance for Cylindricity	Normal, Class 6	$\frac{IT3}{2}$ to $\frac{IT4}{2}$	$\frac{IT4}{2}$ to $\frac{IT5}{2}$
	Class 5, Class 4	$\frac{IT2}{2}$ to $\frac{IT3}{2}$	$\frac{IT2}{2}$ to $\frac{IT3}{2}$
Tolerance for Shoulder Runout	Normal, Class 6	IT3	IT3 to IT4
	Class 5, Class 4	IT3	IT3
Roughness of Fitting Surfaces R_a	Small Bearings	0.8	1.6
	Large Bearings	1.6	3.2

Remarks This table is for general recommendation using radius measuring method, the basic tolerance (IT) class should be selected in accordance with the bearing precision class. Regarding the figures of IT, please refer to the Appendix Table 11 (page C22). In cases that the outer ring is mounted in the housing bore with interference or that a thin cross-section bearing is mounted on a shaft and housing, the accuracy of the shaft and housing should be higher since this affects the bearing raceway directly.

11.2 Shoulder and Fillet Dimensions

The shoulders of the shaft or housing in contact with the face of a bearing must be perpendicular to the shaft center line. (Refer to Table 11.1) The front face side shoulder bore of the housing for a tapered roller bearing should be parallel with the bearing axis in order to avoid interference with the cage.

The fillets of the shaft and housing should not come in contact with the bearing chamfer; therefore, the fillet radius r_a must be smaller than the minimum bearing chamfer dimension r or r_1 .

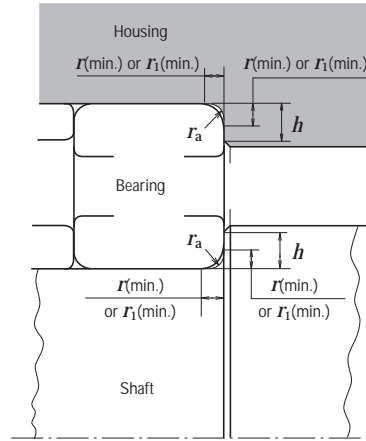

Fig. 11.1 Chamfer Dimensions, Fillet Radius of Shaft and Housing, and Shoulder Height

The shoulder heights for both shafts and housings for radial bearings should be sufficient to provide good support over the face of the bearings, but enough face should extend beyond the shoulder to permit use of special dismounting tools. The recommended minimum shoulder heights for metric series radial bearings are listed in Table 11.2.

Nominal dimensions associated with bearing mounting are listed in the bearing tables including the proper shoulder diameters. Sufficient shoulder height is particularly important for supporting the side ribs of tapered roller bearings and cylindrical roller bearings subjected to high axial loads.

The values of h and r_a in Table 11.2 should be adopted in those cases where the fillet radius of the shaft or housing is as shown in Fig. 11.2 (a), while the values in Table 11.3 are generally used with an undercut fillet radius produced when grinding the shaft as shown in Fig. 11.2 (b).

Table 11.2 Recommended Minimum Shoulder Heights for Use with Metric Series Radial Bearings

Units : mm

Nominal Chamfer Dimensions	Shaft or Housing		
	Fillet Radius	Minimum Shoulder Heights h (min.)	
		Deep Groove Ball Bearings, Self-Aligning Ball Bearings, Cylindrical Roller Bearings, Solid Needle Roller Bearings	Angular Contact Ball Bearings, Tapered Roller Bearings, Spherical Roller Bearings
r (min.) or r_1 (min.)	r_a (max.)		
0.05	0.05	0.2	—
0.08	0.08	0.3	—
0.1	0.1	0.4	—
0.15	0.15	0.6	—
0.2	0.2	0.8	—
0.3	0.3	1	1.25
0.6	0.6	2	2.5
1	1	2.5	3
1.1	1	3.25	3.5
1.5	1.5	4	4.5
2	2	4.5	5
2.1	2	5.5	6
2.5	2	—	6
3	2.5	6.5	7
4	3	8	9
5	4	10	11
6	5	13	14
7.5	6	16	18
9.5	8	20	22
12	10	24	27
15	12	29	32
19	15	38	42

- Remarks**
- When heavy axial loads are applied, the shoulder height must be sufficiently higher than the values listed.
 - The fillet radius of the corner is also applicable to thrust bearings.
 - The shoulder diameter is listed instead of shoulder height in the bearing tables.

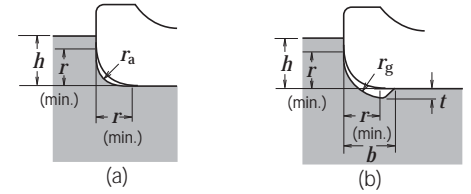

Fig. 11.2 Chamfer Dimensions, Fillet Radius, and Shoulder Height

Table 11.3 Shaft Undercut

Units : mm

Chamfer Dimensions of Inner and Outer Rings r (min.) or r_1 (min.)	Undercut Dimensions		
	t	r_g	b
1	0.2	1.3	2
1.1	0.3	1.5	2.4
1.5	0.4	2	3.2
2	0.5	2.5	4
2.1	0.5	2.5	4
2.5	0.5	2.5	4
3	0.5	3	4.7
4	0.5	4	5.9
5	0.6	5	7.4
6	0.6	6	8.6
7.5	0.6	7	10

For thrust bearings, the squareness and contact area of the supporting face for the bearing rings must be adequate. In the case of thrust ball bearings, the housing shoulder diameter D_a should be less than the pitch circle diameter of the balls, and the shaft shoulder diameter d_a should be greater than the pitch circle diameter of the balls (Fig. 11.3).

For thrust roller bearings, it is advisable for the full contact length between rollers and rings to be supported by the shaft and housing shoulder (Fig. 11.4). These diameters d_a and D_a are listed in the bearing tables.

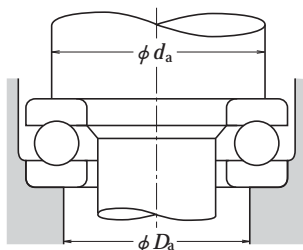

Fig. 11.3 Face Supporting Diameters for Thrust Ball Bearings

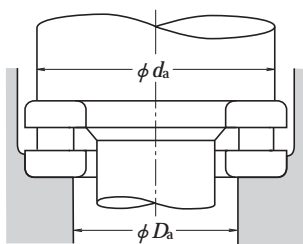

Fig. 11.4 Face Supporting Diameters for Thrust Roller Bearings

11.3 Bearing Seals

To insure the longest possible life of a bearing, it may be necessary to provide seals to prevent leakage of lubricant and entry of dust, water and other harmful material like metallic particles. The seals must be free from excessive running friction and the probability of seizure. They should also be easy to assemble and disassemble. It is necessary to select a suitable seal for each application considering the lubricating method.

11.3.1 Non-Contact Type Seals

Various sealing devices that do not contact the shaft, such as oil grooves, flingers, and labyrinths, are available. Satisfactory sealing can usually be obtained with such seals because of their close running clearance. Centrifugal force may also assist in preventing internal contamination and leakage of the lubricant.

(1) Oil Groove Seals

The effectiveness of oil groove seals is obtained by means of the small gap between the shaft and housing bore and by multiple grooves on either or both of the housing bore and shaft surface (Fig. 11.5 (a), (b)).

Since the use of oil grooves alone is not completely effective, except at low speeds, a flinger or labyrinth type seal is often combined with an oil groove seal (Fig. 11.5 (c)). The entry of dust is impeded by packing grease with a consistency of about 200 into the grooves.

The smaller the gap between the shaft and housing, the greater the sealing effect; however, the shaft and housing must not come in contact while running. The recommended gaps are given in Table 11.4.

The recommended groove width is approximately 3 to 5mm, with a depth of about 4 to 5mm. In the case of sealing methods using grooves only, there should be three or more grooves.

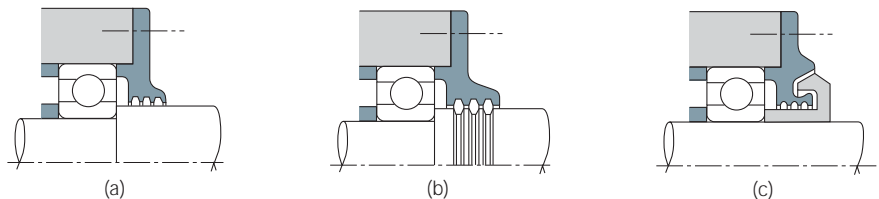

Fig. 11.5 Examples of Oil Grooves

(2) Flinger (Slinger) Type Seals

A flinger is designed to force water and dust away by means of the centrifugal force acting on any contaminants on the shaft. Sealing mechanisms with flingers inside the housing as shown in Fig. 11.6 (a), (b) are mainly intended to prevent oil leakage, and are used in environments with relatively little dust. Dust and moisture are prevented from entering by the centrifugal force of flingers shown in Figs 11.6 (c), (d).

Table 11.4 Gaps between Shafts and Housings for Oil-Groove Type Seals

Units : mm	
Nominal Shaft Diameter	Radial Gap
Under 50	0.25 to 0.4
50-200	0.5 to 1.5

(3) Labyrinth Seals

Labyrinth seals are formed by interdigitated segments attached to the shaft and housing that are separated by a very small gap. They are particularly suitable for preventing oil leakage from the shaft at high speeds.

The type shown in Fig. 11.7 (a) is widely used because of its ease of assembly, but those shown in Fig. 11.7 (b), (c) have better seal effectiveness.

Table 11.5 Labyrinth Seal Gaps

Units : mm		
Nominal Shaft Diameter	Labyrinth Gaps	
	Radial Gap	Axial Gap
Under 50	0.25 to 0.4	1 to 2
50-200	0.5 to 1.5	2 to 5

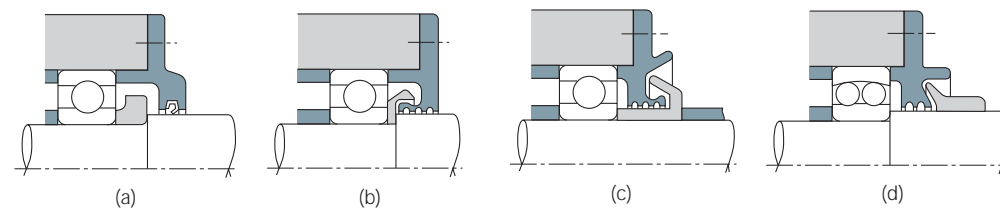

Fig. 11.6 Examples of Flinger Configurations

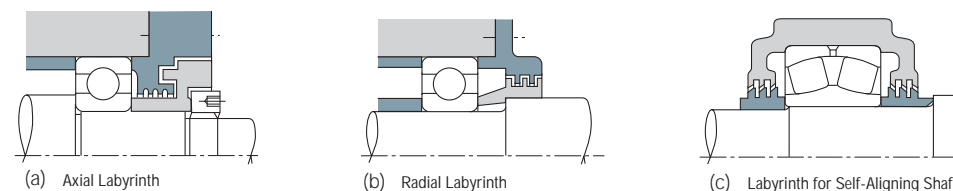

Fig. 11.7 Examples of Labyrinth Designs

11.3.2 Contact Type Seals

The effectiveness of contact seals is achieved by the physical contact between the shaft and seal, which may be made of synthetic rubber, synthetic resin, felt, etc. Oil seals with synthetic rubber lips are most frequently used.

(1) Oil Seals

Many types of oil seals are used to prevent lubricant from leaking out as well as to prevent dust, water, and other foreign matter from entering (Figs. 11.8 and 11.9)

In Japan, such oil seals are standardized (Refer to **JIS B 2402**) on the basis of type and size. Since many oil seals are equipped with circumferential springs to maintain adequate contact force, oil seals can follow the non-uniform rotational movement of a shaft to some degree.

Seal lip materials are usually synthetic rubber including nitrile, acrylate, silicone, and fluorine. Tetrafluoride ethylene is also used. The maximum allowable operating temperature for each material increases in this same order.

Synthetic rubber oil seals may cause trouble such as overheating, wear, and seizure, unless there is an oil film between the seal lip and shaft. Therefore, some lubricant should be applied to the seal lip when the

seals are installed. It is also desirable for the lubricant inside the housing to spread a little between the sliding surfaces. However, please be aware that ester-based grease will cause acrylic rubber material to swell. Also, low aniline point mineral oil, silicone-based grease, and silicon-based oil will cause silicone-based material to swell. Moreover, urea-based grease will cause fluorine-based material to deteriorate.

The permissible circumferential speed for oil seals varies depending on the type, the finish of the shaft surface, liquid to be sealed, temperature, shaft eccentricity, etc. The temperature range for oil seals is restricted by the lip material. Approximate circumferential surface speeds and temperature permitted under favorable conditions are listed in Table 11.6.

When oil seals are used at high circumferential surface speed or under high internal pressure, the contact surface of the shaft must be smoothly finished and the shaft eccentricity should be less than 0.02 to 0.05 mm. The hardness of the shaft's contact surface should be made higher than HRC40 by means of heat treatment or hard chrome plating in order to gain abrasion resistance. If possible, a hardness of more than HRC 55 is recommended.

The approximate level of contact surface finish required for several shaft circumferential surface speeds is given in Table 11.7.

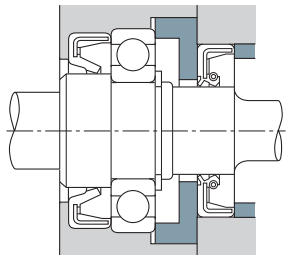

Fig. 11.8 Example of Application of Oil Seal (1)

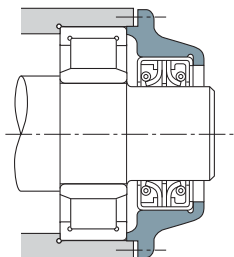

Fig. 11.9 Example of Application of Oil Seal (2)

Table 11.6 Permissible Circumferential Surface Speeds and Temperature Range for Oil Seals

Seal Materials		Permissible Circumferential Speeds(m/sec)	Operating Temperature Range(°C) (1)
Synthetic Rubber	Nitrile Rubber	Under 16	- 25 to +100
	Acrylic Rubber	Under 25	- 15 to +130
	Silicone Rubber	Under 32	- 70 to +200
	Fluorine-contains Rubber	Under 32	- 30 to +200
Tetrafluoride Ethylene Resin		Under 15	- 50 to +220

Note (1) The upper limit of the temperature range may be raised about 20 °C for operation for short intervals.

Table 11.7 Shaft Circumferential Surface Speeds and Finish of Contact Surfaces

Circumferential Surface Speeds(m/s)	Surface Finish Ra (µm)
Under 5	0.8
5 to 10	0.4
Over 10	0.2

(2) Felt Seals

Felt seals are one of the simplest and most common seals being used for transmission shafts, etc.

However, since oil permeation and leakage are unavoidable if oil is used, this type of seal is used only

for grease lubrication, primarily to prevent dust and other foreign matter from entering. Felt seals are not suitable for circumferential surface speeds exceeding 4 m/sec; therefore, it is preferable to replace them with synthetic rubber seals depending on the application.

12. LUBRICATION

12.1 Purposes of Lubrication

The main purposes of lubrication are to reduce friction and wear inside the bearings that may cause premature failure. The effects of lubrication may be briefly explained as follows:

(1) Reduction of Friction and Wear

Direct metallic contact between the bearing rings, rolling elements and cage, which are the basic components of a bearing, is prevented by an oil film which reduces the friction and wear in the contact areas.

(2) Extension of Fatigue Life

The rolling fatigue life of bearings depends greatly upon the viscosity and film thickness between the rolling contact surfaces. A heavy film thickness prolongs the fatigue life, but it is shortened if the viscosity of the oil is too low so the film thickness is insufficient.

(3) Dissipation of Frictional Heat and Cooling

Circulation lubrication may be used to carry away frictional heat or heat transferred from the outside to prevent the bearing from overheating and the oil from deteriorating.

(4) Others

Adequate lubrication also helps to prevent foreign material from entering the bearings and guards against corrosion or rusting.

12.2 Lubricating Methods

The various lubricating methods are first divided into either grease or oil lubrication. Satisfactory bearing performance can be achieved by adopting the lubricating method which is most suitable for the particular application and operating condition.

In general, oil offers superior lubrication; however, grease lubrication allows a simpler structure around the bearings. A comparison of grease and oil lubrication is given in Table 12.1.

Table 12.1 Comparison of Grease and Oil Lubrication

Item	Grease Lubrication	Oil Lubrication
Housing Structure and Sealing Method	Simple	May be complex, Careful maintenance required.
Speed	Limiting speed is 65% to 80% of that with oil lubrication.	Higher limiting speed.
Cooling Effect	Poor	Heat transfer is possible using forced oil circulation.
Fluidity	Poor	Good
Full Lubricant Replacement	Sometimes difficult	Easy
Removal of Foreign Matter	Removal of particles from grease is impossible.	Easy
External Contamination due to Leakage	Surroundings seldom contaminated by leakage.	Often leaks without proper countermeasures. Not suitable if external contamination must be avoided.

12.2.1 Grease Lubrication

(1) Grease Quantity

The quantity of grease to be packed in a housing depends on the housing design and free space, grease characteristics, and ambient temperature. For example, the bearings for the main shafts of machine tools, where the accuracy may be impaired by a small temperature rise, require only a small amount of grease. The quantity of grease for ordinary bearings is determined as follows.

Sufficient grease must be packed inside the bearing including the cage guide face. The available space inside the housing to be packed with grease depends on the speed as follows:

- 1/2 to 2/3 of the space ... When the speed is less than 50% of the limiting speed.
- 1/3 to 1/2 of the space ... When the speed is more than 50% of the limiting speed.

(2) Replacement of Grease

Grease, once packed, usually need not be replenished for a long time; however, for severe operating conditions, grease should be frequently replenished or replaced. In such cases, the bearing housing should be designed to facilitate grease replenishment and replacement. When replenishment intervals are short, provide replenishment and discharge ports at appropriate positions so deteriorated grease is replaced by fresh grease. For example, the housing space on the grease supply side can be divided into several sections with partitions. The grease on the partitioned side gradually passes through the bearings and old grease forced from the bearing is discharged through a grease valve (Fig. 12.1). If a grease valve is not used, the space on

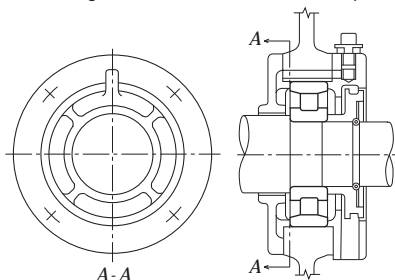

Fig. 12.1 Combination of Partitioned Grease Reservoir and Grease Valve

the discharge side is made larger than the partitioned side so it can retain the old grease, which is removed periodically by removing the cover.

(3) Replenishing Interval

Even if high-quality grease is used, there is deterioration of its properties with time; therefore, periodic replenishment is required. Figs 12.2 (1) and (2) show the replenishment time intervals for various bearing types running at different speeds. Figs.12.2 (1) and (2) apply for the condition of high-quality lithium soap-mineral oil grease, bearing temperature of 70°C, and normal load ($P/C=0.1$).

· Temperature
If the bearing temperature exceeds 70°C, the replenishment time interval must be reduced by half for every 15°C temperature rise of the bearings.

· Grease
In case of ball bearings especially, the replenishing time interval can be extended depending on used grease type. (For example, high-quality lithium soap-synthetic oil grease may extend about two times of replenishing time interval shown in Fig.12.2 (1). If the temperature of the bearings is less than 70°C, the usage of lithium soap-mineral oil grease or lithium soap-synthetic oil grease is appropriate.)

· Load
The replenishing time interval depends on the magnitude of the bearing load. Please refer to Fig.12.2 (3).
If P/C exceeds 0.16, it is advisable to consult NSK.

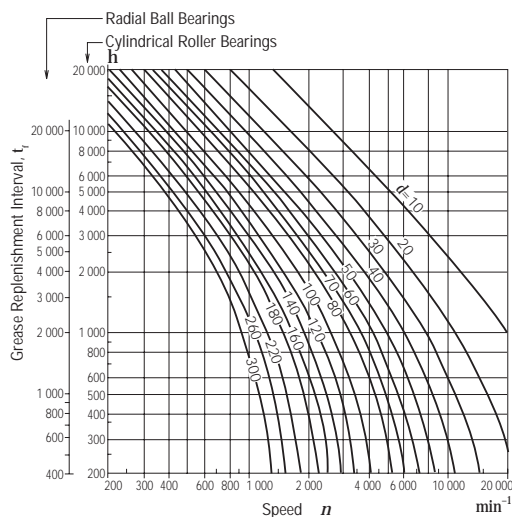

(1) Radial Ball Bearings, Cylindrical Roller Bearings

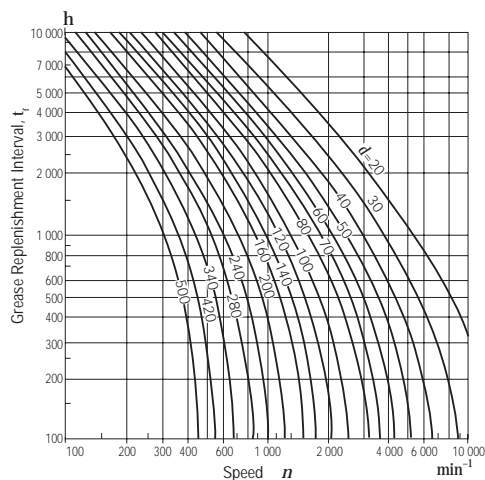

(2) Tapered Roller Bearings, Spherical Roller Bearings

(3) Load factor

P/C	≤ 0.06	0.1	0.13	0.16
Load factor	1.5	1	0.65	0.45

Fig. 12.2 Grease Replenishment Intervals

(4) Grease Life of Sealed Ball Bearings

When grease is packed into single-row deep groove ball bearings, the grease life may be estimated using Equation (12.1) or (12.2) or Fig. 12.3: (General purpose grease (1))

$$\log t = 6.54 - 2.6 \frac{n}{N_{max}} - \left(0.025 - 0.012 \frac{n}{N_{max}}\right) T \quad \dots\dots\dots(12.1)$$

(Wide-range grease (2))

$$\log t = 6.12 - 1.4 \frac{n}{N_{max}} - \left(0.018 - 0.006 \frac{n}{N_{max}}\right) T \quad \dots\dots\dots(12.2)$$

where t : Average grease life, (h)
 n : Speed (min^{-1})
 N_{max} : Limiting speed with grease lubrication (min^{-1}) (values for ZZ and VV types listed in the bearing tables)
 T : Operating temperature °C

Equations (12.1) and (12.2) and Fig. 12.3 apply under the following conditions:

- (a) Speed, n
 $0.25 \leq \frac{n}{N_{max}} \leq 1$
 when $\frac{n}{N_{max}} < 0.25$, assume $\frac{n}{N_{max}} = 0.25$

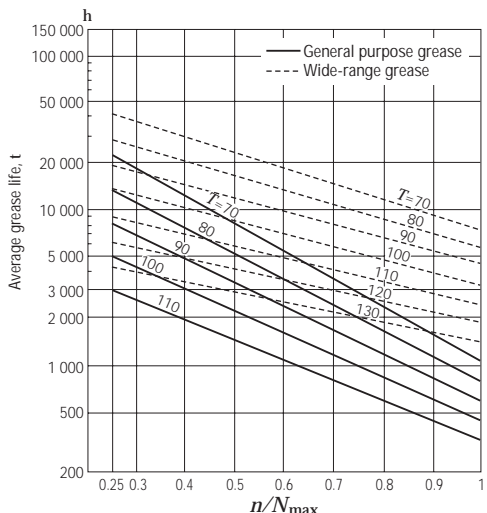

Fig. 12.3 Grease Life of Sealed Ball Bearings

(b) Operating Temperature, T
 For general purpose grease (1)
 $70^\circ\text{C} \leq T \leq 110^\circ\text{C}$

For wide-range grease (2)
 $70^\circ\text{C} \leq T \leq 130^\circ\text{C}$

When $T < 70^\circ\text{C}$ assume $T = 70^\circ\text{C}$

(c) Bearing Loads
 The bearing loads should be about 1/10 or less of the basic load rating C_r .

Notes (1) Mineral-oil base greases (e.g. lithium soap base grease) which are often used over a temperature range of around - 10 to 110 °C.
 (2) Synthetic-oil base greases are usable over a wide temperature range of around - 40 to 130 °C.

12.2.2 Oil Lubrication

(1) Oil Bath Lubrication

Oil bath lubrication is a widely used with low or medium speeds. The oil level should be at the center of the lowest rolling element. It is desirable to provide a sight gauge so the proper oil level may be maintained (Fig. 12.4)

(2) Drip-Feed Lubrication

Drip feed lubrication is widely used for small ball bearings operated at relatively high speeds. As shown in Fig. 12.5, oil is stored in a visible oiler. The oil drip rate is controlled with the screw in the top.

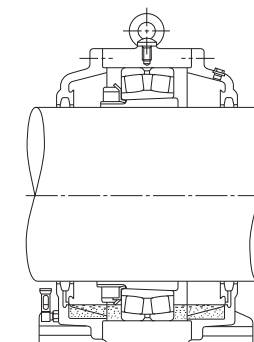

Fig. 12.4 Oil Bath Lubrication

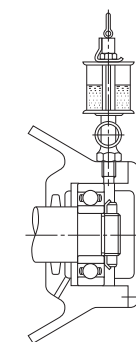

Fig. 12.5 Drip Feed Lubrication

(3) Splash Lubrication

With this lubricating method, oil is splashed onto the bearings by gears or a simple rotating disc installed near bearings without submerging the bearings in oil. It is commonly used in automobile transmissions and final drive gears. Fig. 12.6 shows this lubricating method used on a reduction gear.

(4) Circulating Lubrication

Circulating lubrication is commonly used for high speed operation requiring bearing cooling and for bearings used at high temperatures. As shown in Fig. 12.7 (a), oil is supplied by the pipe on the right side, it travels through the bearing, and drains out through the pipe on the left. After being cooled in a reservoir, it returns to the bearing through a pump and filter.

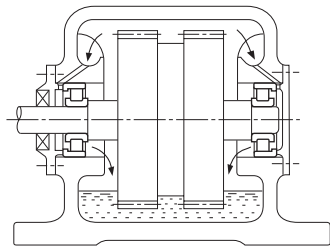

Fig. 12.6 Splash Lubrication

(5) Jet Lubrication

Jet lubrication is often used for ultra high speed bearings, such as the bearings in jet engines with a $d_m n$ valve (d_m : pitch diameter of rolling element set in mm; n : rotational speed in min^{-1}) exceeding one million. Lubricating oil is sprayed under pressure from one or more nozzles directly into the bearing.

Fig. 12.8 shows an example of ordinary jet lubrication. The lubricating oil is sprayed on the inner ring and cage guide face. In the case of high speed operation, the air surrounding the bearing rotates with it causing the oil jet to be deflected. The jetting speed of the oil from the nozzle should be more than 20% of the circumferential speed of the inner ring outer surface (which is also the guide face for the cage).

More uniform cooling and a better temperature distribution is achieved using more nozzles for a given amount of oil. It is desirable for the oil to be forcibly discharged so the agitating resistance of the lubricant can be reduced and the oil can effectively carry away the heat.

(6) Oil Mist Lubrication

Oil mist lubrication, also called oil fog lubrication, utilizes an oil mist sprayed into a bearing. This method has the following advantages:

- (a) Because of the small quantity of oil required, the oil agitation resistance is small, and higher speeds are possible.
- (b) Contamination of the vicinity around the bearing is slight because the oil leakage is small.
- (c) It is relatively easy to continuously supply fresh oil; therefore, the bearing life is extended.

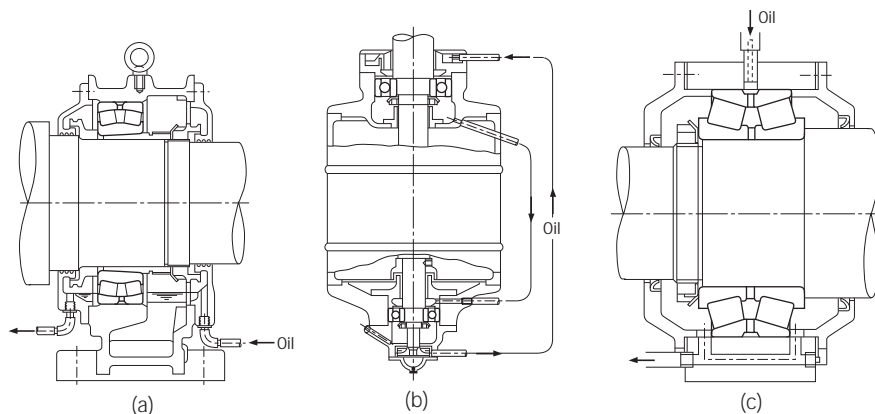

Fig. 12.7 Circulating Lubrication

This lubricating method is used in bearings for the high speed spindles of machine tools, high speed pumps, roll necks of rolling mills, etc (Fig. 12.9). For oil mist lubrication of large bearings, it is advisable to consult NSK.

(7) Oil/Air Lubricating Method

Using the oil/air lubricating method, a very small amount of oil is discharged intermittently by a constant-quantity piston into a pipe carrying a constant flow of compressed air. The oil flows along the wall of the pipe and approaches a constant flow rate.

- The major advantages of oil/air lubrication are:
 - (a) Since the minimum necessary amount of oil is supplied, this method is suitable for high speeds because less heat is generated.
 - (b) Since the minimum amount of oil is fed continuously, bearing temperature remains stable. Also, because of the small amount of oil, there is almost no atmospheric pollution.
 - (c) Since only fresh oil is fed to the bearings, oil deterioration need not be considered.
 - (d) Since compressed air is always fed to the bearings, the internal pressure is high, so dust, cutting fluid, etc. cannot enter.
- For these reasons, this method is used in the main spindles of machine tools and other high speed applications (Fig. 12.10).

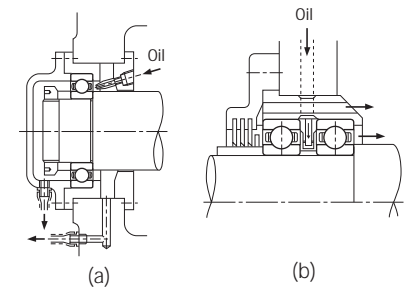

Fig. 12.8 Jet Lubrication

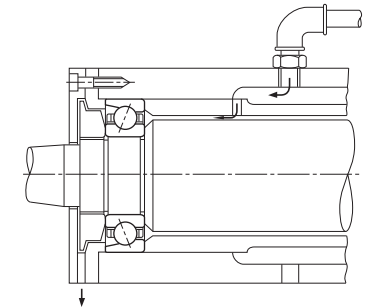

Fig. 12.9 Oil Mist Lubrication

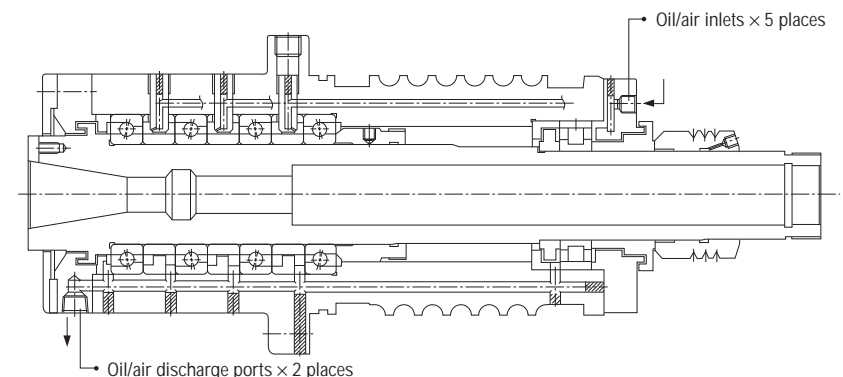

Fig. 12.10 Oil/Air Lubrication

12.3 Lubricants

12.3.1 Lubricating Grease

Grease is a semi-solid lubricant consisting of base oil, a thickener and additives. The main types and general properties of grease are shown in Table 12.2. It should be remembered that different brands of the same type of grease may have different properties.

(1) Base Oil

Mineral oils or synthetic oils such as silicone or diester oil are mainly used as the base oil for grease. The lubricating properties of grease depend mainly on the characteristics of its base oil. Therefore, the viscosity of the base oil is just as important when selecting grease as when selecting an oil. Usually, grease made with low viscosity base oils is more suitable for high speeds and low temperatures, while greases made with high viscosity base oils are more suited for high temperatures and heavy loads.

However, the thickener also influences the lubricating properties of grease; therefore, the selection criteria for grease is not the same as for lubricating oil. Moreover, please be aware that ester-based grease will cause acrylic rubber material to swell, and that silicone-based grease will cause silicone-based material to swell.

(2) Thickener

As thickeners for lubricating grease, there are several types of metallic soaps, inorganic thickeners such as silica gel and bentonite, and heat resisting organic thickeners such as polyurea and fluorine compounds.

The type of thickener is closely related to the grease dropping point (1); generally, grease with a high dropping point also has a high temperature capability during operation. However, this type of grease does not have a high working temperature unless the base oil is heat-resistant. The highest possible working temperature for grease should be determined considering the heat resistance of the base oil.

The water resistance of grease depends upon the type of thickener. Sodium soap grease or compound grease containing sodium soap emulsifies when exposed to water or high humidity, and therefore, cannot be used where moisture is prevalent. Moreover, please be aware that urea-based grease will cause fluorine-based material to deteriorate.

Note (1) The grease dropping point is that temperature at which a grease heated in a specified small container becomes sufficiently fluid to drip.

Table 12.2

Name (Popular name)	Lithium Grease		
	Li Soap		
Thickener			
Base Oil	Mineral Oil	Diester Oil, Polyatomic Ester Oil	Silicone Oil
Properties			
Dropping Point, °C	170 to 195	170 to 195	200 to 210
Working Temperatures, °C	-20 to +110	-50 to +130	-50 to +160
Working Speed, % ⁽¹⁾	70	100	60
Mechanical Stability	Good	Good	Good
Pressure Resistance	Fair	Fair	Poor
Water Resistance	Good	Good	Good
Rust Prevention	Good	Good	Poor
Remarks	General purpose grease used for numerous applications	Good low temperature and torque characteristics. Often used for small motors and instrument bearings. Pay attention to rust caused by insulation varnish.	Mainly for high temperature applications. Unsuitable for bearings for high and low speeds or heavy loads or those having numerous sliding-contact areas (roller bearings, etc.)

Note (1) The values listed are percentages of the limiting speeds given in the bearing tables.

(3) Additives

Grease often contains various additives such as antioxidants, corrosion inhibitors, and extreme pressure additives to give it special properties. It is recommended that extreme pressure additives be used in heavy load applications. For long use without replenishment, an antioxidant should be added.

(4) Consistency

Consistency indicates the “softness” of grease. Table 12.3 shows the relation between consistency and working conditions.

Grease Properties

Sodium Grease (Fiber Grease)	Calcium Grease (Cup Grease)	Mixed Base Grease	Complex Base Grease (Complex Grease)	Non-Soap Base Grease (Non-Soap Grease)	
Na Soap	Ca Soap	Na + Ca Soap, Li + Ca Soap, etc.	Ca Complex Soap, Al Complex Soap, Li Complex Soap, etc.	Urea, Bentonite, Carbon Black, Fluoric Compounds, Heat Resistant Organic Compound, etc.	
Mineral Oil	Mineral Oil	Mineral Oil	Mineral Oil	Mineral Oil	Synthetic Oil (Ester Oil, Polyatomic Ester Oil, Synthetic Hydrocarbon Oil, Silicone Oil, Fluoric Based Oil)
170 to 210	70 to 90	160 to 190	180 to 300	> 230	> 230
-20 to +130	-20 to +60	-20 to +80	-20 to +130	-10 to +130	< +220
70	40	70	70	70	40 to 100
Good	Poor	Good	Good	Good	Good
Fair	Poor	Fair to Good	Fair to Good	Fair	Fair
Poor	Good	Poor for Na Soap Grease	Good	Good	Good
Poor to Good	Good	Fair to Good	Fair to Good	Fair to Good	Fair to Good
Long and short fiber types are available. Long fiber grease is unsuitable for high speeds. Attention to water and high temperature is required.	Extreme pressure grease containing high viscosity mineral oil and extreme pressure additive (Pb soap, etc.) has high pressure resistance.	Often used for roller bearings and large ball bearing.	Suitable for extreme pressures mechanically stable	Mineral oil base grease is middle and high temperature purpose lubricant. Synthetic oil base grease is recommended for low or high temperature. Some silicone and fluorine oil based grease have poor rust prevention and noise.	

Remarks The grease properties shown here can vary between brands.

Table 12.3 Consistency and Working Conditions

Consistency Number	0	1	2	3	4
Consistency ⁽¹⁾ 1/10 mm	355 to 385	310 to 340	265 to 295	220 to 250	175 to 205
Working Conditions (Application)	·For centralized oiling ·When fretting is likely to occur	·For centralized oiling ·When fretting is likely to occur ·For low temperatures	·For general use ·For sealed ball bearings	·For general use ·For sealed ball bearings ·For high temperatures	·For high temperatures ·For grease seals

Note (1) Consistency: The depth to which a cone descends into grease when a specified weight is applied, indicated in units of 1/10mm. The larger the value, the softer the grease.

(5) Mixing Different Types of Grease

In general, different brands of grease must not be mixed. Mixing grease with different types of thickeners may destroy its composition and physical properties. Even if the thickeners are of the same type, possible differences in the additive may cause detrimental effects.

12.3.2 Lubricating Oil

The lubricating oils used for rolling bearings are usually highly refined mineral oil or synthetic oil that have a high oil film strength and superior oxidation and corrosion resistance. When selecting a lubricating oil, the viscosity at the operating conditions is important. If the viscosity is too low, a proper oil film is not formed and abnormal wear and seizure may occur. On the other hand, if the viscosity is too high, excessive viscous resistance may cause heating or large power loss. In general, low viscosity oils should be used at high speed; however, the viscosity should increase

with increasing bearing load and size.

Table 12.4 gives generally recommended viscosities for bearings under normal operating conditions. For use when selecting the proper lubricating oil, Fig. 12.11 shows the relationship between oil temperature and viscosity, and examples of selection are shown in Table 12.5.

Table 12. 4 Bearing Types and Proper Viscosity of Lubricating Oils

Bearing Type	Proper Viscosity at Operating Temperature
Ball Bearings and Cylindrical Roller Bearings	Higher than 13mm ² /s
Tapered Roller Bearings and Spherical Roller Bearings	Higher than 20mm ² /s
Spherical Thrust Roller Bearings	Higher than 32mm ² /s

Remarks 1mm²/s=1cSt (centistokes)

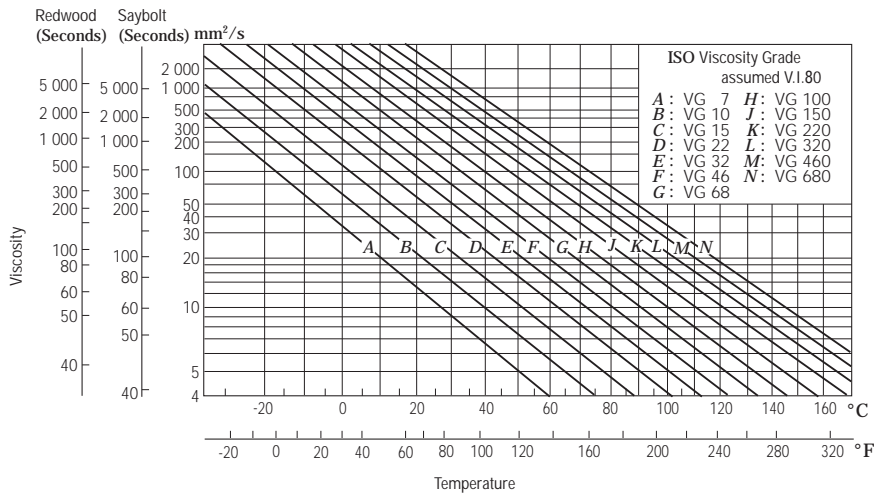

Fig. 12.11 Temperature-Viscosity Chart

Oil Replacement Intervals

Oil replacement intervals depend on the operating conditions and oil quantity.

In those cases where the operating temperature is less than 50°C, and the environmental conditions are good with little dust, the oil should be replaced approximately once a year. However, in cases where the oil temperature is about 100°C, the oil must be changed at least once every three months.

If moisture may enter or if foreign matter may be mixed in the oil, then the oil replacement interval must be shortened.

Mixing different brands of oil must be prevented for the same reason given previously for grease.

Table 12. 5 Examples of Selection Lubricating Oils

Operating Temperature	Speed	Light or normal Load	Heavy or Shock Load
-30 to 0 °C	Less than limiting speed	ISO VG 15, 22, 32 (refrigerating machine oil)	—
0 to 50 °C	Less than 50% of limiting speed	ISO VG 32, 46, 68 (bearing oil, turbine oil)	ISO VG 46, 68, 100 (bearing oil, turbine oil)
	50 to 100% of limiting speed	ISO VG 15, 22, 32 (bearing oil, turbine oil)	ISO VG 22, 32, 46 (bearing oil, turbine oil)
	More than limiting speed	ISO VG 10, 15, 22 (bearing oil)	—
50 to 80 °C	Less than 50% of limiting speed	ISO VG 100, 150, 220 (bearings oil)	ISO VG 150, 220, 320 (bearing oil)
	50 to 100% of limiting speed	ISO VG 46, 68, 100 (bearing oil, turbine oil)	ISO VG 68, 100, 150 (bearing oil, turbine oil)
	More than limiting speed	ISO VG 32, 46, 68 (bearing oil, turbine oil)	—
80 to 110 °C	Less than 50% of limiting speed	ISO VG 320, 460 (bearing oil)	ISO VG 460, 680 (bearing oil, gear oil)
	50 to 100% of limiting speed	ISO VG 150, 220 (bearing oil)	ISO VG 220, 320 (bearing oil)
	More than limiting speed	ISO VG 68, 100 (bearing oil, turbine oil)	—

- Remarks
1. For the limiting speed, use the values listed in the bearing tables.
 2. Refer to Refrigerating Machine Oils (JIS K 2211), Bearing Oils (JIS K 2239), Turbine Oils (JIS K 2213), Gear Oils (JIS K 2219).
 3. If the operating temperature is near the high end of the temperature range listed in the left column, select a high viscosity oil.
 4. If the operating temperature is lower than -30°C or higher than 110°C, it is advisable to consult NSK.

13. BEARING MATERIALS

The bearing rings and rolling elements of rolling bearings are subjected to repetitive high pressure with a small amount of sliding. The cages are subjected to tension and compression and sliding contact with the rolling elements and either or both of the bearing rings.

Therefore, the materials used for the rings, rolling elements, and cages require the following characteristics:

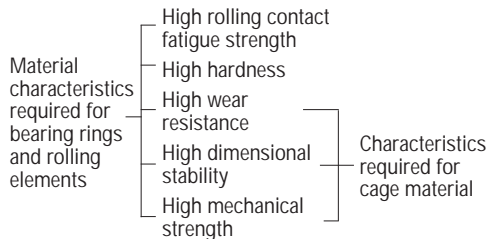

Other necessary characteristics, such as easy production, shock and heat resistance, and corrosion resistance, are required depending on individual applications.

13.1 Materials for Bearing Rings and Rolling Elements

Primarily, high carbon chromium bearing steel (Table 13.1) is used for the bearing rings and rolling elements. Most NSK bearings are made of **SUJ2** among the **JIS** steel types listed in Table 13.1, while the larger bearings generally use **SUJ3**. The chemical composition of **SUJ2** is approximately the same as **AISI 52100** specified in the USA, **DIN 100 Cr6** in Germany, and **BS 535A99** in England.

For bearings that are subjected to very severe shock loads, carburized low-carbon alloy steels such as chrome steel, chrome molybdenum steel, nickel chrome molybdenum steel, etc. are often used. Such steels, when they are carburized to the proper depth and have sufficient surface hardness, are more shock resistant than normal, through-hardened bearing steels because of the softer energy-absorbing core. The chemical composition of common carburized bearing steels is listed in Table 13.2.

Table 13. 1 Chemical Composition of High-Carbon Chromium Bearing Steel (Major Elements)

Standard	Symbols	Chemical Composition (%)						
		C	Si	Mn	P	S	Cr	Mo
JIS G 4805	SUJ 2	0.95 to 1.10	0.15 to 0.35	Less than 0.50	Less than 0.025	Less than 0.025	1.30 to 1.60	—
	SUJ 3	0.95 to 1.10	0.40 to 0.70	0.90 to 1.15	Less than 0.025	Less than 0.025	0.90 to 1.20	—
	SUJ 4	0.95 to 1.10	0.15 to 0.35	Less than 0.50	Less than 0.025	Less than 0.025	1.30 to 1.60	0.10 to 0.25
ASTM A 295	52100	0.93 to 1.05	0.15 to 0.35	0.25 to 0.45	Less than 0.025	Less than 0.015	1.35 to 1.60	Less than 0.10

Table 13. 2 Chemical Composition of Carburizing Bearing Steels (Major Elements)

Standard	Symbols	Chemical Composition (%)							
		C	Si	Mn	P	S	Ni	Cr	Mo
JIS G 4052	SCr 420 H	0.17 to 0.23	0.15 to 0.35	0.55 to 0.95	Less than 0.030	Less than 0.030	Less than 0.25	0.85 to 1.25	—
	SCM 420 H	0.17 to 0.23	0.15 to 0.35	0.55 to 0.95	Less than 0.030	Less than 0.030	Less than 0.25	0.85 to 1.25	0.15 to 0.35
	SNCM 220 H	0.17 to 0.23	0.15 to 0.35	0.60 to 0.95	Less than 0.030	Less than 0.030	0.35 to 0.75	0.35 to 0.65	0.15 to 0.30
	SNCM 420 H	0.17 to 0.23	0.15 to 0.35	0.40 to 0.70	Less than 0.030	Less than 0.030	1.55 to 2.00	0.35 to 0.65	0.15 to 0.30
JIS G 4053	SNCM 815	0.12 to 0.18	0.15 to 0.35	0.30 to 0.60	Less than 0.030	Less than 0.030	4.00 to 4.50	0.70 to 1.00	0.15 to 0.30
ASTM A 534	8620 H	0.17 to 0.23	0.15 to 0.35	0.60 to 0.95	Less than 0.025	Less than 0.015	0.35 to 0.75	0.35 to 0.65	0.15 to 0.25
	4320 H	0.17 to 0.23	0.15 to 0.35	0.40 to 0.70	Less than 0.025	Less than 0.015	1.55 to 2.00	0.35 to 0.65	0.20 to 0.30
	9310 H	0.07 to 0.13	0.15 to 0.35	0.40 to 0.70	Less than 0.025	Less than 0.015	2.95 to 3.55	1.00 to 1.40	0.08 to 0.15

Table 13. 3 Chemical Composition of High Speed Steel for Bearings Used at High Temperatures

Standard	Symbols	Chemical Composition (%)											
		C	Si	Mn	P	S	Cr	Mo	V	Ni	Cu	Co	W
AISI	M50	0.77 to 0.85	Less than 0.25	Less than 0.35	Less than 0.015	Less than 0.015	3.75 to 4.25	4.00 to 4.50	0.90 to 1.10	Less than 0.10	Less than 0.10	Less than 0.25	Less than 0.25

NSK uses highly pure vacuum-degassed bearing steel containing a minimum of oxygen, nitrogen, and hydrogen compound impurities. The rolling fatigue life of bearings has been remarkably improved using this material combined with the appropriate heat treatment. For special purpose bearings, high temperature bearing steel, which has superior heat resistance, and stainless steel having good corrosion resistance may be used. The chemical composition of these special materials are given in Tables 13.3 and 13.4.

13.2 Cage Materials

The low carbon steels shown in Table 13.5 are the main ones for the pressed cages for bearings. Depending on the purpose, brass or stainless steel may be used. For machined cages, high strength brass (Table 13.6) or carbon steel (Table 13.5) is used. Sometimes synthetic resin is also used.

Table 13. 4 Chemical Composition of Stainless Steel for Rolling Bearing (Major Elements)

Standard	Symbols	Chemical Composition (%)						
		C	Si	Mn	P	S	Cr	Mo
JIS G 4303	SUS 440 C	0.95 to 1.20	Less than 1.00	Less than 1.00	Less than 0.040	Less than 0.030	16.00 to 18.00	Less than 0.75
SAE J 405	51440 C	0.95 to 1.20	Less than 1.00	Less than 1.00	Less than 0.040	Less than 0.030	16.00 to 18.00	Less than 0.75

Table 13. 5 Chemical Composition of Steel sheet and Carbon Steel for Cages (Major Elements)

Classification	Standard	Symbols	Chemical Composition (%)				
			C	Si	Mn	P	S
Steel sheet and strip for pressed cages	JIS G 3141	SPCC	Less than 0.12	—	Less than 0.50	Less than 0.04	Less than 0.045
	BAS 361	SPB 2	0.13 to 0.20	Less than 0.30	0.25 to 0.60	Less than 0.03	Less than 0.030
	JIS G 3311	S 50 CM	0.47 to 0.53	0.15 to 0.35	0.60 to 0.90	Less than 0.03	Less than 0.035
Carbon steel for machined cages	JIS G 4051	S 25 C	0.22 to 0.28	0.15 to 0.35	0.30 to 0.60	Less than 0.03	Less than 0.035

Remarks BAS is Japanese Bearing Association Standard.

Table 13. 6 Chemical Composition of High Strength Brass for Machined Cages

Standard	Symbols	Chemical Composition (%)									
		Cu	Zn	Mn	Fe	Al	Sn	Ni	Impurities		
										Pb	Si
JIS H 5120	CAC301 (HBsC 1)	55.0 to 60.0	33.0 to 42.0	0.1 to 1.5	0.5 to 1.5	0.5 to 1.5	Less than 1.0	Less than 1.0	Less than 0.4	Less than 0.1	Less than 0.1
JIS H 3250	C 6782	56.0 to 60.5	Residual	0.5 to 2.5	0.1 to 1.0	0.2 to 2.0	—	—	Less than 0.5	—	—

Remarks Improved HBsC 1 is also used.

14. BEARING HANDLING

14.1 Precautions for Proper Handling of Bearings

Since rolling bearings are high precision machine parts, they must be handled accordingly. Even if high quality bearings are used, their expected performance cannot be achieved if they are not handled properly. The main precautions to be observed are as follows:

(1) Keep Bearings and Surrounding Area Clean

Dust and dirt, even if invisible to the naked eye, have harmful effects on bearings. It is necessary to prevent the entry of dust and dirt by keeping the bearings and their environment as clean as possible.

(2) Careful Handling

Heavy shocks during handling may cause bearings to be scratched or otherwise damaged possibly resulting in their failure. Excessively strong impacts may cause brinelling, breaking, or cracking.

(3) Use Proper Tools

Always use the proper equipment when handling bearings and avoid general purpose tools.

(4) Prevent Corrosion

Since perspiration on the hands and various other contaminants may cause corrosion, keep the hands clean when handling bearings. Wear gloves if possible. Pay attention to rust of bearing caused by corrosive gasses.

14.2 Mounting

The method of mounting rolling bearings strongly affects their accuracy, life, and performance, so their mounting deserves careful attention. Their characteristics should first be thoroughly studied, and then they should be mounted in the proper manner. It is recommended that the handling procedures for bearings be fully investigated by the design engineers and that standards be established with respect to the following items:

- (1) Cleaning the bearings and related parts.
- (2) Checking the dimensions and finish of related parts.
- (3) Mounting
- (4) Inspection after mounting.
- (5) Supply of lubricants.

Bearings should not be unpacked until immediately before mounting. When using ordinary grease lubrication, the grease should be packed in the bearings without first cleaning them. Even in the case of ordinary oil lubrication, cleaning the bearings is not required. However, bearings for instruments or for high speed operation must first be cleaned with clean filtered oil in order to remove the anti-corrosion agent.

After the bearings are cleaned with filtered oil, they should be protected to prevent corrosion.

Prelubricated bearings must be used without cleaning. Bearing mounting methods depend on the bearing type and type of fit. As bearings are usually used on rotating shafts, the inner rings require a tight fit.

Bearings with cylindrical bores are usually mounted by pressing them on the shafts (press fit) or heating them to expand their diameter (shrink fit). Bearings with tapered bores can be mounted directly on tapered shafts or cylindrical shafts using tapered sleeves.

Bearings are usually mounted in housings with a loose fit. However, in cases where the outer ring has an interference fit, a press may be used. Bearings can be interference-fitted by cooling them before mounting using dry ice. In this case, a rust preventive treatment must be applied to the bearing because moisture in the air condenses on its surface.

14.2.1 Mounting of Bearings with Cylindrical Bores

(1) Press Fits

Fitting with a press is widely used for small bearings. A mounting tool is placed on the inner ring as shown in Fig. 14.1 and the bearing is slowly pressed on the shaft with a press until the side of the inner ring rests against the shoulder of the shaft. The mounting tool must not be placed on the outer ring for press mounting, since the bearing may be damaged. Before mounting, applying oil to the fitted shaft surface is recommended for smooth insertion. The mounting method using a hammer should only be used for small ball bearings with minimally tight fits and when a press is not available. In the case of tight interference fits or for medium and large bearings, this method should not be used. Any time a hammer is used, a mounting tool must be placed on the inner ring.

When both the inner and outer rings of non-separable bearings, such as deep groove ball bearings, require tight-fit, a mounting tool is placed on both rings as shown in Fig. 14.2, and both rings are fitted at the same time using a screw or hydraulic press. Since the outer ring of self-aligning ball bearings may deflect a mounting tool such as that shown in Fig. 14.2 should always be used for mounting them.

In the case of separable bearings, such as cylindrical roller bearings and tapered roller bearings, the inner and outer rings may be mounted separately. Assembly of the inner and outer rings, which were previously mounted separately, should be done carefully to align the inner and outer rings correctly. Careless or forced assembly may cause scratches on the rolling contact surfaces.

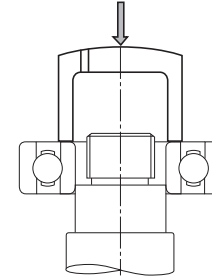

Fig. 14.1 Press Fitting Inner Ring

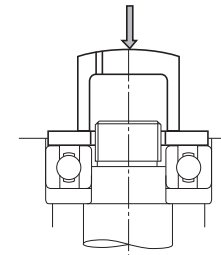

Fig. 14.2 Simultaneous Press Fitting of Inner and Outer Rings

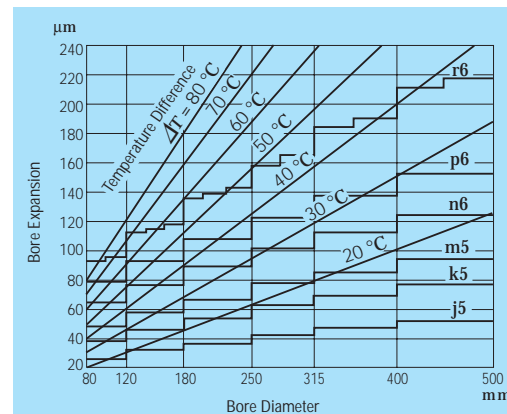

Fig. 14.3 Temperature and Thermal Expansion of Inner Ring

(2) Shrink Fits

Since press fitting large bearings requires a large force, a shrink fit is widely used. The bearings are first heated in oil to expand them before mounting.

This method prevents an excessive force from being imposed on the bearings and allows mounting them in a short time.

The expansion of the inner ring for various temperature differences and bearing sizes is shown in Fig. 14.3.

The precautions to follow when making shrink fits are as follows:

- (a) Do not heat bearings to more than 120°C.
- (b) Put the bearings on a wire net or suspend them in an oil tank in order to prevent them from touching the tank's bottom directly.
- (c) Heat the bearings to a temperature 20 to 30°C higher than the lowest temperature required for mounting without interference since the inner ring will cool a little during mounting.
- (d) After mounting, the bearings will shrink in the axial direction as well as the radial direction while cooling. Therefore, press the bearing firmly against the shaft shoulder using locating methods to avoid a clearance between the bearing and shoulder.

NSK Bearing Induction Heaters

Besides heating in oil, NSK Bearing Heaters, which use electromagnetic induction to heat bearings, are widely used. (Refer to Page C7.)

In NSK Bearing Heaters, electricity (AC) in a coil produces a magnetic field that induces a current inside the bearing that generates heat. Consequently, without using flames or oil uniform heating in a short time is possible, making bearing shrink fitting efficient and clean.

In the case of relatively frequent mounting and dismantling such as cylindrical roller bearings for roll necks of rolling mills and for railway journal boxes, induction heating should be used for mounting and dismantling inner rings.

14.2.2 Mounting of Bearings with Tapered Bores

Bearings with tapered bores are mounted on tapered shafts directly or on cylindrical shafts with adapters or withdrawal sleeves (Figs. 14.4 and 14.5). Large spherical roller bearings are often mounted using hydraulic pressure. Fig. 14.6 shows a bearing mounting utilizing a sleeve and hydraulic nut. Fig. 14.7 shows another mounting method. Holes are drilled in the sleeve which are used to feed oil under pressure to the bearing seat. As the bearing expands radially, the sleeve is inserted axially with adjusting bolts.

Spherical roller bearings should be mounted while checking their radial-clearance reduction and referring to the push-in amounts listed in Table 14.1. The radial clearance must be measured using clearance gauges.

In this measurement, as shown in Fig. 14.8, the clearance for both rows of rollers must be measured simultaneously, and these two values should be kept roughly the same by adjusting the relative position of the outer and inner rings.

When a large bearing is mounted on a shaft, the outer ring may be deformed into an oval shape by its own weight. If the clearance is measured at the lowest part of the deformed bearing, the measured value may be bigger than the true value. If an incorrect radial internal clearance is obtained in this manner and the values in Table 14.1 are used, then the interference fit may

become too tight and the true residual clearance may become too small. In this case, as shown in Fig. 14.9, one half of the total clearance at points *a* and *b* (which are on a horizontal line passing through the bearing center) and *c* (which is at the lowest position of the bearing) may be used as the residual clearance. When a self-aligning ball bearing is mounted on a shaft with an adapter, be sure that the residual clearance does not become too small. Sufficient clearance for easy alignment of the outer ring must be allowed.

14.3 Operation Inspection

After the mounting has been completed, a running test should be conducted to determine if the bearing has been mounted correctly. Small machines may be manually operated to assure that they rotate smoothly. Items to be checked include sticking due to foreign matter or visible flaws, uneven torque caused by improper mounting or an improper mounting surface, and excessive torque caused by an inadequate clearance, mounting error, or seal friction. If there are no abnormalities, powered operation may be started.

Table 14.1 Mounting of Spherical Roller Bearings with Tapered Bores

Units : mm

Bearing Bore Diameter <i>d</i>		Reduction in Radial Clearance		Push-in amount in axial direction				Minimum Permissible Residual Clearance	
				Taper 1 : 12		Taper 1 : 30			
over	incl.	min.	max.	min.	max.	min.	max.	CN	C3
30	40	0.025	0.030	0.40	0.45	—	—	0.010	0.025
40	50	0.030	0.035	0.45	0.55	—	—	0.015	0.030
50	65	0.030	0.035	0.45	0.55	—	—	0.025	0.035
65	80	0.040	0.045	0.60	0.70	—	—	0.030	0.040
80	100	0.045	0.055	0.70	0.85	1.75	2.15	0.035	0.050
100	120	0.050	0.060	0.75	0.90	1.9	2.25	0.045	0.065
120	140	0.060	0.070	0.90	1.1	2.25	2.75	0.055	0.080
140	160	0.065	0.080	1.0	1.3	2.5	3.25	0.060	0.100
160	180	0.070	0.090	1.1	1.4	2.75	3.5	0.070	0.110
180	200	0.080	0.100	1.3	1.6	3.25	4.0	0.070	0.110
200	225	0.090	0.110	1.4	1.7	3.5	4.25	0.080	0.130
225	250	0.100	0.120	1.6	1.9	4.0	4.75	0.090	0.140
250	280	0.110	0.140	1.7	2.2	4.25	5.5	0.100	0.150
280	315	0.120	0.150	1.9	2.4	4.75	6.0	0.110	0.160
315	355	0.140	0.170	2.2	2.7	5.5	6.75	0.120	0.180
355	400	0.150	0.190	2.4	3.0	6.0	7.5	0.130	0.200
400	450	0.170	0.210	2.7	3.3	6.75	8.25	0.140	0.220
450	500	0.190	0.240	3.0	3.7	7.5	9.25	0.160	0.240
500	560	0.210	0.270	3.4	4.3	8.5	11.0	0.170	0.270
560	630	0.230	0.300	3.7	4.8	9.25	12.0	0.200	0.310
630	710	0.260	0.330	4.2	5.3	10.5	13.0	0.220	0.330
710	800	0.280	0.370	4.5	5.9	11.5	15.0	0.240	0.390
800	900	0.310	0.410	5.0	6.6	12.5	16.5	0.280	0.430
900	1 000	0.340	0.460	5.5	7.4	14.0	18.5	0.310	0.470
1 000	1 120	0.370	0.500	5.9	8.0	15.0	20.0	0.360	0.530

Remarks The values for reduction in radial internal clearance are for bearings with CN clearance. For bearing with C3 Clearance, the maximum values listed should be used for the reduction in radial internal clearance.

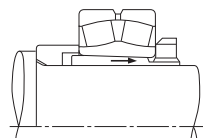

Fig. 14.4 Mounting with Adapter

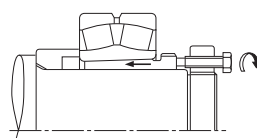

Fig. 14.5 Mounting with Withdrawal Sleeve

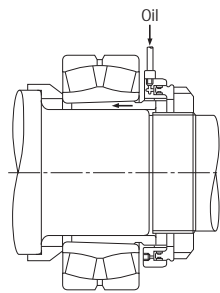

Fig. 14.6 Mounting with Hydraulic Nut

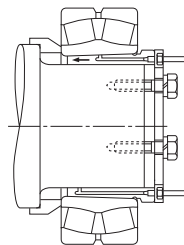

Fig. 14.7 Mounting with Special Sleeve and Hydraulic Pressure

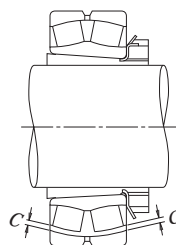

Fig. 14.8 Clearance Measurement of Spherical Roller Bearing

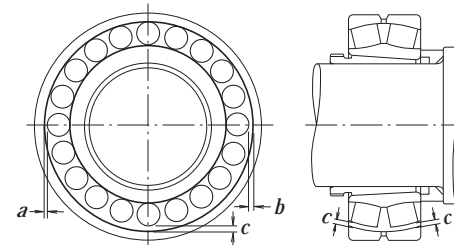

Fig. 14.9 Measuring Clearance in Large Spherical Roller Bearing

Large machines, which cannot be turned by hand, can be started after examination with no load, and the power immediately cutoff and the machine allowed to coast to a stop. Confirm that there is no abnormality such as vibration, noise, contact of rotating parts, etc. Powered operation should be started slowly without load and the operation should be observed carefully until it is determined that no abnormalities exist, then gradually increase the speed, load, etc. to their normal levels. Items to be checked during the test operation include the existence of abnormal noise, excessive rise of bearing temperature, leakage and contamination of lubricants, etc. If any abnormality is found during the test operation, it must be stopped immediately and the machine should be inspected. If necessary, the bearing should be dismantled for examination.

Although the bearing temperature can generally be estimated by the temperature of the outside surface of the housing, it is more desirable to directly measure the temperature of the outer ring using oil holes for access.

The bearing temperature should rise gradually to the steady state level within one to two hours after the operation starts. If the bearing or its mounting is improper, the bearing temperature may increase rapidly and become abnormally high. The cause of this abnormal temperature may be an excessive amount of lubricant, insufficient bearing clearance, incorrect

mounting, or excessive friction of the seals.

In the case of high speed operation, an incorrect selection of bearing type or lubricating method may also cause an abnormal temperature rise.

The sound of a bearing may be checked with a noise locator or other instruments. Abnormal conditions are indicated by a loud metallic sound, or other irregular noise, and the possible cause may include incorrect lubrication, poor alignment of the shaft and housing, or the entry of foreign matter into the bearing. The possible causes and measures for irregularities are listed in Table 14.2.

Table 14. 2 Causes of and Measures for Operating Irregularities

Irregularities		Possible Causes	Measures
Noise	Loud Metallic Sound (†)	Abnormal Load	Improve the fit, internal clearance, preload, position of housing shoulder, etc.
		Incorrect mounting	Improve the machining accuracy and alignment of shaft and housing, accuracy of mounting method.
		Insufficient or improper Lubricant	Replenish the lubricant or select another lubricant.
		Contact of rotating parts	Modify the labyrinth seal, etc.
	Loud Regular Sound	Flaws, corrosion, or scratches on raceways	Replace or clean the bearing, improve the seals, and use clean lubricant.
		Brinelling	Replace the bearing and use care when handling bearings.
Irregular Sound	Flaking on raceway	Replace the bearing.	
	Excessive clearance	Improve the fit, clearance and preload.	
	Penetration of foreign particles	Replace or clean the bearing, improve the seals, and use clean lubricant.	
Abnormal Temperature Rise	Flaws or flaking on balls	Replace the bearing.	
	Excessive amount of lubricant	Reduce amount of lubricant, select stiffer grease.	
	Insufficient or improper lubricant	Replenish lubricant or select a better one.	
	Abnormal load	Improve the fit, internal clearance, preload, position of housing shoulder.	
	Incorrect mounting	Improve the machining accuracy and alignment of shaft and housing, accuracy of mounting, or mounting method.	
Vibration (Axial runout)	Creep on fitted surface, excessive seal friction	Correct the seals, replace the bearing, correct the fitting or mounting.	
	Brinelling	Replace the bearing and use care when handling bearings.	
	Flaking	Replace the bearing.	
	Incorrect mounting	Correct the squareness between the shaft and housing shoulder or side of spacer.	
Leakage or Discoloration of Lubricant	Penetration of foreign particles	Replace or clean the bearing, improve the seals.	
	Too much lubricant, Penetration by foreign matter or abrasion chips	Reduce the amount of lubricant, select a stiffer grease. Replace the bearing or lubricant. Clean the housing and adjacent parts.	

Note (†) Intermittent squeal or high-pitch noise may be heard in medium- to large-sized cylindrical roller bearings or ball bearings that are operating under grease lubrication in low-temperature environments. Under such low-temperature conditions, bearing temperature will not rise resulting in fatigue nor is grease performance affected. Although intermittent squeal or high-pitch noise may occur under these conditions, the bearing is fully functional and can continue to be used. In the event that greater noise reduction or quieter running properties are needed, please contact your nearest NSK branch office.

14.4 Dismounting

A bearing may be removed for periodic inspection or for other reasons. If the removed bearing is to be used again or it is removed only for inspection, it should be dismantled as carefully as when it was mounted. If the bearing has a tight fit, its removal may be difficult. The means for removal should be considered in the original design of the adjacent parts of the machine. When dismantling, the procedure and sequence of removal should first be studied using the machine drawing and considering the type of mounting fit in order to perform the operation properly.

14.4.1 Dismounting of Outer Rings

In order to remove an outer ring that is tightly fitted, first place bolts in the push-out holes in the housing at several locations on its circumference as shown in Fig. 14.10, and remove the outer ring by uniformly tightening the bolts. These bolt holes should always be fitted with blank plugs when not being used for dismantling. In the case of separable bearings, such as tapered roller bearings, some notches should be made at several positions in the housing shoulder, as shown in Fig. 14.11, so the outer ring may be pressed out using a dismantling tool or by tapping it.

14.4.2 Dismounting of Bearings with Cylindrical Bores

If the mounting design allows space to press out the inner ring, this is an easy and fast method. In this case, the withdrawal force should be imposed only on the inner ring (Fig. 14.12). Withdrawal tools like those shown in Figs. 14.13 and 14.14 are often used.

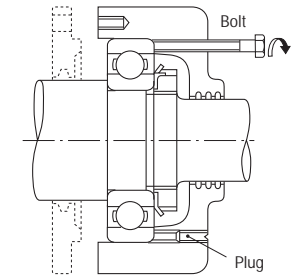

Fig. 14.10 Removal of Outer Ring with Dismounting Bolts

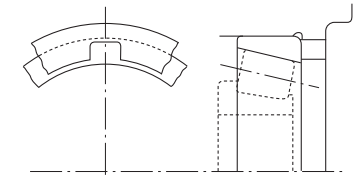

Fig. 14.11 Removal Notches

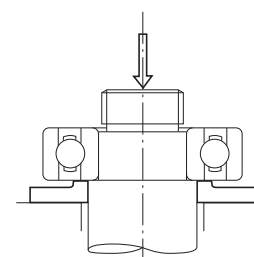

Fig. 14.12 Removal of Inner Ring Using a Press

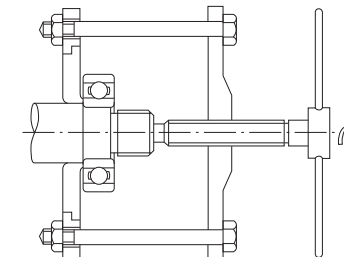

Fig. 14.13 Removal of Inner Ring Using Withdrawal Tool (1)

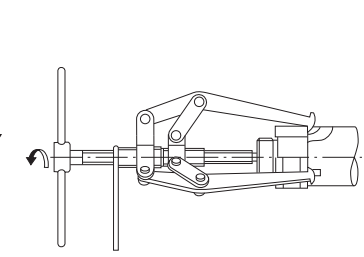

Fig. 14.14 Removal of Inner Ring Using Withdrawal Tool (2)

In both cases, the claws of the tools must substantially engage the face of the inner ring; therefore, it is advisable to consider the size of the shaft shoulder or to cut grooves in the shoulder to accommodate the withdrawal tools (Fig. 14.14).

The oil injection method is usually used for the withdrawal of large bearings. The withdrawal is achieved easily by means of oil pressure applied through holes in the shaft. In the case of extra wide bearings, the oil injection method is used together with a withdrawal tool.

Induction heating is used to remove the inner rings of NU and NJ types of cylindrical roller bearings. The inner rings are expanded by brief local heating, and then withdrawn (Fig. 14.15). Induction heating is also used to mount several bearings of these types on a shaft.

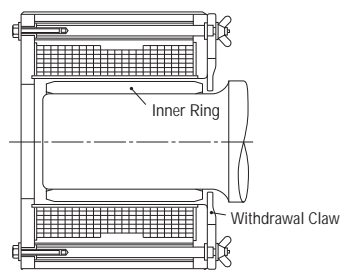

Fig. 14.15 Removal of Inner Ring Using Induction Heater

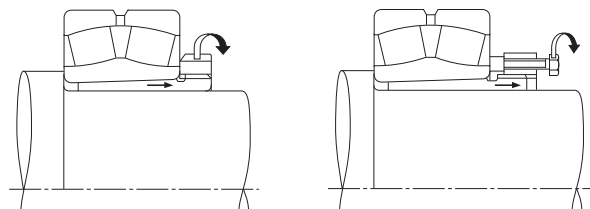

Fig. 14.16 Removal of Withdrawal Sleeve Using Withdrawal Nut (1)

Fig. 14.17 Removal of Withdrawal Sleeve Using Withdrawal Nut (2)

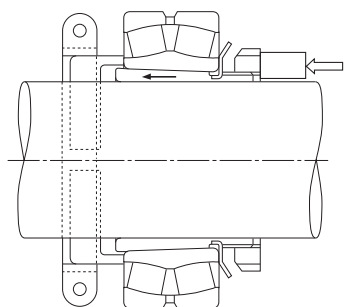

Fig. 14.18 Removal of Adapter with Stop and Axial Pressure

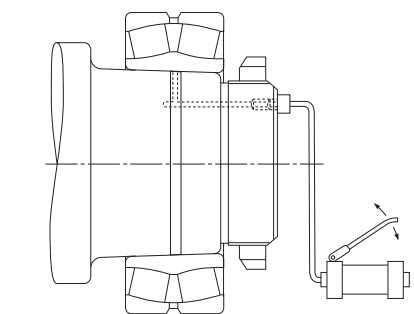

Fig. 14.19 Removal Using Oil Injection Hydraulic Pump

14.4.3 Dismounting of Bearings with Tapered Bores

When dismounting relatively small bearings with adapters, the inner ring is held by a stop fastened to the shaft and the nut is loosened several turns. This is followed by hammering on the sleeve using a suitable tool as shown in Fig. 14.18. Fig. 14.16 shows one procedure for dismounting a withdrawal sleeve by tightening the removal nut. If this procedure is difficult, it may be possible to drill and tap bolt holes in the nut and withdraw the sleeve by tightening the bolts as shown in Fig. 14.17.

Large bearings may be withdrawn easily using oil pressure. Fig. 14.19 illustrates the removal of a bearing by forcing oil under pressure through a hole and groove in a tapered shaft to expand the inner ring. The bearing may suddenly move axially when the interference is relieved during this procedure so a stop nut is recommended for protection. Fig. 14.20 shows a withdrawal using a hydraulic nut.

14.5 Inspection of Bearings

14.5.1 Bearing Cleaning

When bearings are inspected, the appearance of the bearings should first be recorded and the amount and condition of the residual lubricant should be checked.

After the lubricant has been sampled for examination, the bearings should be cleaned. In general, light oil or kerosene may be used as a cleaning solution.

Dismounted bearings should first be given a preliminary cleaning followed by a finishing rinse. Each bath should be provided with a metal net to support the bearings in the oil without touching the sides or bottom of the tank. If the bearings are rotated with foreign matter in them during preliminary cleaning, the raceways may be damaged. The lubricant and other deposits should be removed in the oil bath during the initial rough cleaning with a brush or other means. After the bearing is relatively clean, it is given the finishing rinse. The finishing rinse should be done carefully with the bearing being rotated while immersed in the rinsing oil. It is necessary to always keep the rinsing oil clean.

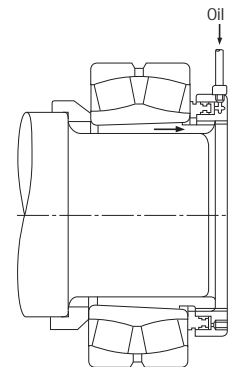

Fig. 14.20 Removal Using Hydraulic Nut

14.5.2 Inspection and Evaluation of Bearings

After being thoroughly cleaned, bearings should be examined for the condition of their raceways and external surfaces, the amount of cage wear, the increase in internal clearance, and degradation of tolerances. These should be carefully checked, in addition to examination for possible damage or other abnormalities, in order to determine the possibility for its reuse.

In the case of small non-separable ball bearings, hold the bearing horizontally in one hand, and then rotate the outer ring to confirm that it turns smoothly.

Separable bearings such as tapered roller bearings may be checked by individually examining their rolling elements and the outer ring raceway.

Large bearings cannot be rotated manually; however, the rolling elements, raceway surfaces, cages, and contact surface of the ribs should be carefully examined visually. The more important a bearing is, the more carefully it should be inspected.

The determination to reuse a bearing should be made only after considering the degree of bearing wear, the function of the machine, the importance of the bearings in the machine, operating conditions, and the time until the next inspection. However, if any of the following defects exist, reuse is impossible and replacement is necessary.

- When there are cracks in the inner or outer rings, rolling elements, or cage.
- When there is flaking of the raceway or rolling elements.
- When there is significant smearing of the raceway surfaces, ribs, or rolling elements.
- When the cage is significantly worn or rivets are loose.
- When there is rust or scoring on the raceway surfaces or rolling elements.
- When there are any significant impact or brinell traces on the raceway surfaces or rolling elements.
- When there is significant evidence of creep on the bore or the periphery of the outer ring.
- When discoloration by heat is evident.
- When significant damage to the seals or shields of grease sealed bearings has occurred.

14.6 Maintenance and Inspection

14.6.1 Detecting and Correcting Irregularities

In order to maintain the original performance of a bearing for as long as possible, proper maintenance and inspection should be performed. If proper procedures are used, many bearing problems can be avoided and the reliability, productivity, and operating costs of the equipment containing the bearings are all improved. It is suggested that periodic maintenance be done following the procedure specified. This periodic maintenance encompasses the supervision of operating conditions, the supply or replacement of lubricants, and regular periodic inspection. Items that should be regularly checked during operation include bearing noise, vibration, temperature, and lubrication. If an irregularity is found during operation, the cause should be determined and the proper corrective actions should be taken after referring to Table 14.2. If necessary, the bearing should be dismounted and examined in detail. As for the procedure for dismounting and inspection, refer to Section 14.5, Inspection of Bearings.

NSK BEARING MONITOR (Bearing Abnormality Detector)

It is important during operation to detect signs of irregularities early before damage becomes severe. The NSK Bearing Monitor (see Page C5) is an instrument that checks the condition of bearings and gives a warning of any abnormality, or it stops a machine automatically in order to prevent serious trouble. In addition, it helps to improve maintenance and reduce its cost.

14.6.2 Bearing Failures and Measures

In general, if rolling bearings are used correctly they will survive to their predicted fatigue life. However, they often fail prematurely due to avoidable mistakes. In contrast to fatigue life, this premature failure is caused by improper mounting, handling, or lubrication, entry of foreign matter, or abnormal heat generation. For instance, the causes of rib scoring, as one example of premature failure, may include insufficient lubrication, use of improper lubricant, faulty lubrication system, entry of foreign matter, bearing mounting error, excessive deflection of the shaft, or any combination of these. Thus, it is difficult to determine the real cause of some premature failures. If all the conditions at the time of failure and previous to the time of failure are known, including the application, the operating conditions, and environment; then by studying the nature of the failure and its probable causes, the possibility of similar future failures can be reduced. The most frequent types of bearing failure, along with their causes and corrective actions, are listed in Table 14.3.

Table 14.3 Causes and Measures for Bearing Failures

Type of Failure	Probable Causes	Measures
Flaking		
Flaking of one-side of the raceway of radial bearing.	Abnormal axial load.	A loose fit should be used when mounting the outer ring of free-end bearings to allow axial expansion of the shaft.
Flaking of the raceway in symmetrical pattern.	Out-of-roundness of the housing bore.	Correct the faulty housing.
Flaking pattern inclined relative to the raceway in radial ball bearings. Flaking near the edge of the raceway and rolling surfaces in roller bearings.	Improper mounting, deflection of shaft, inadequate tolerances for shaft and housing.	Use care in mounting and centering, select a bearing with a large clearance, and correct the shaft and housing shoulder.
Flaking of raceway with same spacing as rolling elements.	Large shock load during mounting, rusting while bearing is out of operation for prolonged period.	Use care in mounting and apply a rust preventive when machine operation is suspended for a long time.
Premature flaking of raceway and rolling elements.	Insufficient clearance, excessive load, improper lubrication, rust, etc.	Select proper fit, bearing clearance, and lubricant.
Premature flaking of duplex bearings.	Excessive preload.	Adjust the preload.

Type of Failure	Probable Causes	Measures
Scoring		
Scoring or smearing between raceway and rolling surfaces.	Inadequate initial lubrication, excessively hard grease and high acceleration when starting.	Use a softer grease and avoid rapid acceleration.
Spiral scoring or smearing of raceway surface of thrust ball bearing.	Raceway rings are not parallel and excessive speed.	Correct the mounting, apply a preload, or select another bearing type.
Scoring or smearing between the end face of the rollers and guide rib.	Inadequate lubrication, incorrect mounting and large axial load.	Select proper lubricant and modify the mounting.
Cracks		
Crack in outer or inner ring.	Excessive shock load, excessive interference in fitting, poor surface cylindricity, improper sleeve taper, large fillet radius, development of thermal cracks and advancement of flaking.	Examine the loading conditions, modify the fit of bearing and sleeve. The fillet radius must be smaller than the bearing chamfer.
Crack in rolling element. Broken rib.	Advancement of flaking, shock applied to the rib during mounting or dropped during handling.	Be careful in handling and mounting.
Fractured cage.	Abnormal loading of cage due to incorrect mounting and improper lubrication.	Reduce the mounting error and review the lubricating method and lubricant.
Indentations		
Indentations in raceway in same pattern as rolling elements.	Shock load during mounting or excessive load when not rotating.	Use care in handling.
Indentations in raceway and rolling elements.	Foreign matter such as metallic chips or sand.	Clean the housing, improve the seals, and use a clean lubricant.
Abnormal Wear		
False brinelling (phenomenon similar to brinelling)	Vibration of the bearing without rotation during shipment or rocking motion of small amplitude.	Secure the shaft and housing, use oil as a lubricant and reduce vibration by applying a preload.
Fretting	Slight wear of the fitting surface.	Increase interference and apply oil.
Wearing of raceway, rolling elements, rib, and cage.	Penetration by foreign matter, incorrect lubrication, and rust.	Improve the seals, clean the housing, and use a clean lubricant.
Creep	Insufficient interference or insufficient tightening of sleeve.	Modify the fit or tighten the sleeve
Seizure		
Discoloration and melting of raceway, rolling elements, and ribs.	Insufficient clearance, incorrect lubrication, or improper mounting.	Review the internal clearance and bearing fit, supply an adequate amount of the proper lubricant and improve the mounting method and related parts.
Electric Burn		
Fluting or corrugations.	Melting due to electric arcing.	Install a ground wire to stop the flow of electricity or insulate the bearing.
Corrosion & Rust		
Rust and corrosion of fitting surfaces and bearing interior.	Condensation of water from the air, or fretting. Penetration by corrosive substance (especially varnish-gas, etc).	Use care in storing and avoid high temperature and high humidity, treatment for rust prevention is necessary when operation is stopped for long time. Selection of varnish and grease.

15. TECHNICAL DATA

DEFINITIONS OF SYMBOLS AND THEIR UNITS

	Page
15.1 AXIAL DISPLACEMENT OF BEARINGS	A 128
(1) Contact Angle and Axial Displacement of Deep Groove Ball Bearings and Angular Contact Ball Bearings	A 128
(2) Axial Load and Axial Displacement of Tapered Roller Bearings	A 128
15.2 FITS	A 130
(1) Surface Pressure, Maximum Stress on Fitted Surfaces and Expansion or Contraction of Raceway Diameter	A 130
(2) Interferences or Clearances for Shafts and Inner Rings	A 130
(3) Interferences or Clearances for Housing Bores and Outer Rings	A 130
15.3 RADIAL AND AXIAL INTERNAL CLEARANCES	A 132
(1) Radial and Axial Internal Clearances for Single-Row Deep Groove Ball Bearings	A 132
(2) Radial and Axial Internal Clearances for Double-Row Angular Contact Ball Bearings	A 132
15.4 PRELOAD AND STARTING TORQUE	A 134
(1) Axial Load and Starting Torque of Tapered Roller Bearings	A 134
(2) Preload and Starting Torque of Angular Contact Ball Bearings and Double-Direction Angular Contact Thrust Ball Bearings	A 134
15.5 COEFFICIENTS OF FRICTION AND OTHER BEARING DATA	A 136
(1) Bearing Types and Their Coefficients of Friction	A 136
(2) Circumferential Speed of Rolling Elements about Their Centers and Bearing Center	A 136
(3) Radial Internal Clearance and Fatigue Life	A 136
15.6 BRANDS AND PROPERTIES OF LUBRICATING GREASES	A 138

Symbols	Nomenclature	Units	Symbols	Nomenclature	Units
<i>a</i>	Contact Ellipse Major Axis	(mm)	<i>n_a</i>	Rotating Speed of Rolling Elements	(min ⁻¹)
<i>b</i>	Contact Ellipse Major Axis	(mm)	<i>n_c</i>	Revolving Speed of Rolling Elements (Cape Speed)	(min ⁻¹)
<i>C_r</i>	Basic Dynamic Load Rating of Radial Bearings	(N){kgf}	<i>n_e</i>	Speed of Outer Ring	(min ⁻¹)
<i>C_{0r}</i>	Basic Static Load Radial of Radial Bearings	(N){kgf}	<i>n_i</i>	Speed of Inner Ring	(min ⁻¹)
<i>C_a</i>	Basic Dynamic Load Rating of Thrust Bearings	(N){kgf}	<i>p_m</i>	Surface Pressure on Fitted Surface	(MP _a){kgf/mm ² }
<i>C_{0a}</i>	Basic Static Load Rating of Thrust Bearings	(N){kgf}	<i>P</i>	Bearing Load	(N){kgf}
<i>d</i>	Shaft Diameter, Nominal Bearing Bore Diameter	(mm)	<i>Q</i>	Rolling Element Load	(N){kgf}
<i>D</i>	Housing Bore Diameter, Nominal Bearing Outside Diameter	(mm)	<i>r_e</i>	Groove Radius of Outer Ring	(mm)
<i>D_e</i>	Outer Ring Raceway Diameter	(mm)	<i>r_i</i>	Groove Radius of Inner Ring	(mm)
<i>D_i</i>	Inner Ring Raceway Diameter	(mm)	<i>v_a</i>	Circumferential Speed of Rolling Element about Its Center	(m/sec)
<i>D₀</i>	Housing Outside Diameter	(mm)	<i>v_c</i>	Circumferential Speed of Rolling Element about Bearing Center	(m/sec)
<i>D_{pw}</i>	Rolling Element Pitch Diameter	(mm)	<i>Z</i>	Number of Rolling Elements per Row	
<i>D_w</i>	Nominal Rolling Element Diameter	(mm)	<i>α</i>	Contact Angle (when axial load is applied on Radial Ball Bearing)	(°)
<i>e</i>	Contact Position of Tapered Roller End Face with Rib	(mm)	<i>α₀</i>	Initial Contact Angle (Geometri) (when inner and outer rings of Angular Contact Ball Bearings are pushed axially)	(°)
<i>E</i>	Modulus of Longitudinal Elasticity (Bearing Steel) 208 000 MP _a {21 200 kgf/mm ² }		<i>α_R</i>	Initial Contact Angle (Geometric) (when inner and outer rings Angular Contact Ball Bearing are pushed radially)	(°)
<i>E(k)</i>	Complete elliptic integral of the 2nd kind for which the population parameter is $k = \sqrt{1 - \left(\frac{b}{a}\right)^2}$		<i>β</i>	1/2 of Conical Angle of Roller	(°)
<i>f₀</i>	factor which depends on the geometry of the bearing components and on the applicable stress level		<i>δ_a</i>	Relative Axial Displacement of Inner and Outer Rings	(mm)
<i>f(ε)</i>	Function of ε		<i>Δ_a</i>	Axial Internal Clearance	(mm)
<i>F_a</i>	Axial Load, Preload	(N){kgf}	<i>Δ_d</i>	Effective Interference of Inner Ring and Shaft	(mm)
<i>F_r</i>	Radial Load	(N){kgf}	<i>Δ_r</i>	Radial Internal Clearance	(mm)
<i>h</i>	<i>D_e/D</i>		<i>Δ_D</i>	Effective Interference of Outer Ring and Housing	(mm)
<i>h₀</i>	<i>D/D₀</i>		<i>Δ_{D_e}</i>	Contraction of Outer Ring Raceway Diameter due to Fit	(mm)
<i>k</i>	<i>d/D_i</i>		<i>Δ_{D_i}</i>	Expansion of Inner Ring Raceway Diameter dus to Fit	(mm)
<i>K</i>	Constant Determined by Internal Design of Bearing		<i>ε</i>	Load Factor	
<i>L</i>	Fatigue Life when Effective Clearance is 0		<i>μ</i>	Coefficient of Dynamic Friction of Rolling Bearing	
<i>L_{we}</i>	Effective Leng of Roller	(mm)	<i>μ_e</i>	Coefficient of Friction between Roller End Face and Rib	
<i>L_ε</i>	Fatigue Life when Effective Clearance is <i>Δ</i>		<i>μ_s</i>	Coefficient of Sliding Friction	
<i>m₀</i>	Distance between Centers of Curvature of Inner and Outer Rings $ri + re - Dw$	(mm)	<i>σ_{t max}</i>	Maximum Stress on Fitted Surfaces	(MP _a){kgf/mm ² }
<i>M</i>	Frictional Torque	(N·mm){kgf·mm}			
<i>M_s</i>	Spin Friction	(N·mm){kgf·mm}			

15.1 Axial Displacement of Bearings

(1) Contact Angle α and Axial Displacement δ_a of Deep Groove Ball Bearing and Angular Contact Ball Bearings (Figs. 15.1 to 15.3)

$$\delta_a = \frac{0.00044}{\sin \alpha} \left(\frac{Q^2}{D_w} \right)^{\frac{1}{3}} \dots\dots\dots (N) \left. \vphantom{\frac{0.00044}{\sin \alpha}} \right\} (mm)$$

$$\delta_a = \frac{0.002}{\sin \alpha} \left(\frac{Q^2}{D_w} \right)^{\frac{1}{3}} \dots\dots\dots (kgf) \left. \vphantom{\frac{0.002}{\sin \alpha}} \right\}$$

$$Q = \frac{F_a}{Z \sin \alpha} \dots\dots\dots (N), (kgf)$$

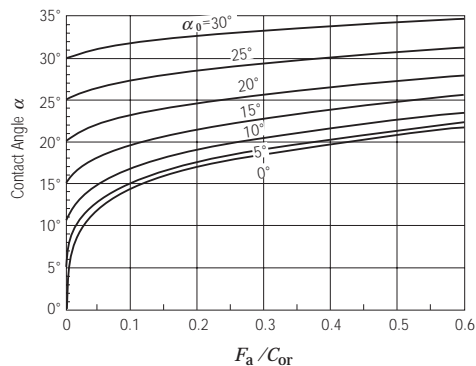

Fig. 15.1 F_a/C_{Or} and Contact Angle of Deep Groove and Angular Contact Ball Bearings

(2) Axial Load F_a and Axial Displacement δ_a of Tapered Roller Bearings (Fig. 15.4)

$$\delta_a = \frac{0.000077 F_a^{0.9}}{(\sin \alpha)^{1.9} Z^{0.9} L_{we}^{0.8}} \dots\dots\dots (N) \left. \vphantom{\frac{0.000077 F_a^{0.9}}{(\sin \alpha)^{1.9} Z^{0.9} L_{we}^{0.8}}} \right\} (mm)$$

$$\delta_a = \frac{0.0006 F_a^{0.9}}{(\sin \alpha)^{1.9} Z^{0.9} L_{we}^{0.8}} \dots\dots\dots (kgf) \left. \vphantom{\frac{0.0006 F_a^{0.9}}{(\sin \alpha)^{1.9} Z^{0.9} L_{we}^{0.8}}} \right\}$$

Remarks:
Actual axial displacement may vary depending on the shaft/housing thickness, material, and fitting interference with the bearing. Please contact NSK about such factors of axial displacement which are not discussed in detail in this catalog.

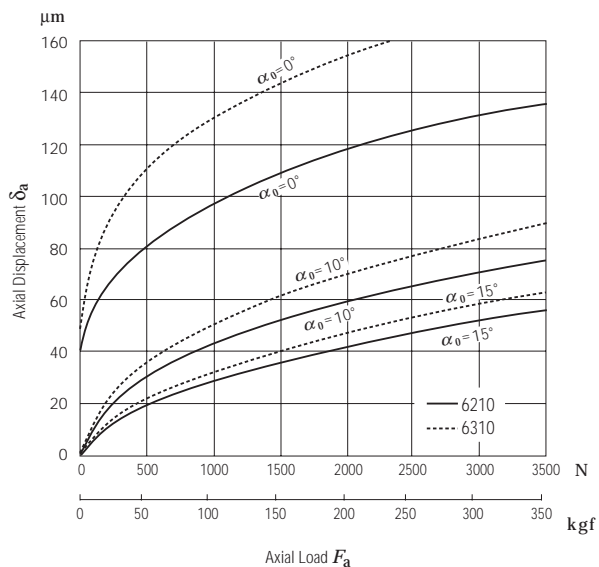

Fig. 15.2 Axial Load and Axial Displacement of Deep Groove Ball Bearings

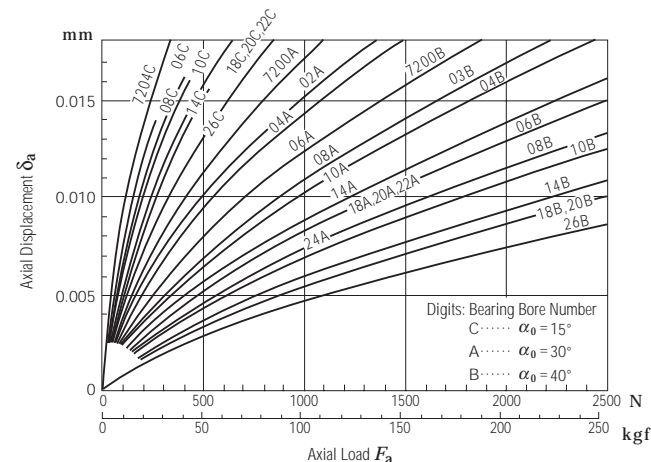

Fig. 15.3 Axial Load and Axial Displacement of Angular Contact Ball Bearings

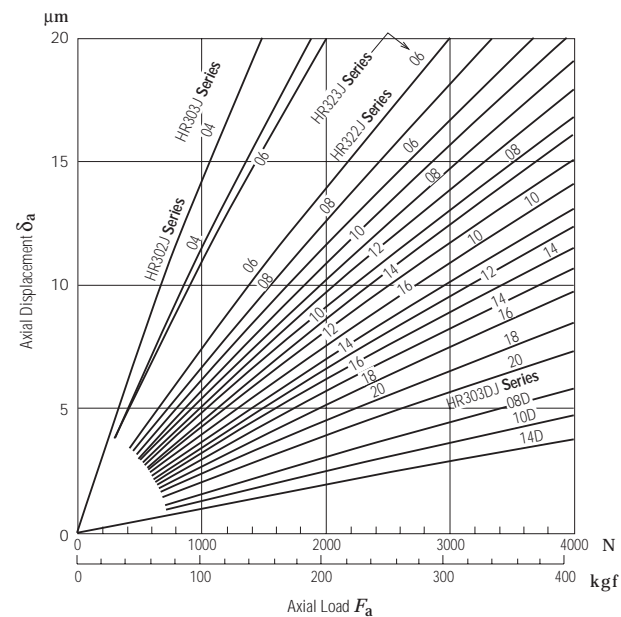

Fig. 15.4 Axial Load and Axial Displacement of Tapered Roller Bearings

15.2 Fits

- (1) Surface Pressure p_m , Maximum Stress $\sigma_{t \max}$ on Fitted Surfaces and Expansion of Inner Ring Raceway Diameter ΔD_i or Contraction of Outer Ring Raceway Diameter ΔD_e (Table 15.1, Figs. 15.5 and 15.6)
- (2) Interferences or Clearances of Shafts and Inner Rings (Table 15.2)
- (3) Interferences or Clearances of Housing Bores and Outer Rings (Table 15.3)

Table 15. 1 Surface Pressure, Maximum Stress on Fitted Surfaces and Expansion or Contraction

Items	Shaft & Inner Ring	Housing & Bore & Outer Ring
Surface Pressure p_m (MPa) {kgf/mm ² }	(In case of solid shaft) $p_m = \frac{E}{2} \frac{\Delta d}{D} (1 - k^2)$	In case of housing outside dia. $D_0 \neq \infty$ $p_m = \frac{E}{2} \frac{\Delta D}{D} \frac{(1 - H^2)(1 - h_0^2)}{1 - H^2 h_0^2}$ In case $D_0 = \infty$ $p_m = \frac{E}{2} \frac{\Delta D}{D} (1 - H^2)$
Maximum stress $\sigma_{t \max}$ (MPa) {kgf/mm ² }	Maximum circumferential stress on fitted surface of inner ring bore is $\sigma_{t \max} = p_m \frac{1 + k^2}{1 - k^2}$	Maximum circumferential stress on outer ring bore surface is $\sigma_{t \max} = p_m \frac{2}{1 - H^2}$
Expansion of inner ring raceway dia. ΔD_i (mm) Contraction of outer ring raceway dia. ΔD_e (mm)	In case of solid shaft $\Delta D_i = \Delta d \cdot k$	In case $D_0 \neq \infty$ $\Delta D_e = \Delta D \cdot h \frac{1 - h_0^2}{1 - H^2 h_0^2}$ In case $D_0 = \infty$ $\Delta D_e = \Delta D \cdot h$

Remarks The modulus of longitudinal elasticity and Poisson's ratio for the shaft and housing material are the same as those for inner and outer rings.

Reference 1 MPa=1 N/mm²=0.102 kgf/mm²

Table 15. 2 Interferences or Clearances

Size Classification (mm)	Single Plane Mean Bore Dia. Deviation (Normal) Δd_{mp}		Interferences or Clearances for															
			f6		g5		g6		h5		h6		js5		j5			
			Clearance	Interference	Clearance	Interference	Clearance	Interference	Clearance	Interference	Clearance	Interference	Clearance	Interference	Clearance	Interference		
over incl.	high low	max. min.	max. max.	max. max.	max. max.	max. max.	max. max.	max. max.	max. max.	max. max.	max. max.	max. max.	max. max.	max. max.	max. max.	max. max.		
3 6	0 - 8	18 2	9 4	12 4	5 8	8 8	—	—	—	—	—	—	—	—	—	—		
6 10	0 - 8	22 5	11 3	14 3	6 8	9 8	3 11	2 12	—	—	—	—	—	—	—	—		
10 18	0 - 8	27 8	14 2	17 2	8 8	11 8	4 12	3 13	—	—	—	—	—	—	—	—		
18 30	0 - 10	33 10	16 3	20 3	9 10	13 10	4.5 14.5	4 15	—	—	—	—	—	—	—	—		
30 50	0 - 12	41 13	20 3	25 3	11 12	16 12	5.5 17.5	5 18	—	—	—	—	—	—	—	—		
50 65	0 - 15	49 15	23 5	29 5	13 15	19 15	6.5 21.5	7 21	—	—	—	—	—	—	—	—		
65 80	0 - 15	49 15	23 5	29 5	13 15	19 15	6.5 21.5	7 21	—	—	—	—	—	—	—	—		
80 100	0 - 20	58 16	27 8	34 8	15 20	22 20	7.5 27.5	9 26	—	—	—	—	—	—	—	—		
100 120	0 - 20	58 16	27 8	34 8	15 20	22 20	7.5 27.5	9 26	—	—	—	—	—	—	—	—		
120 140	0 - 25	68 18	32 11	39 11	18 25	25 25	9 34	11 32	—	—	—	—	—	—	—	—		
140 160	0 - 25	68 18	32 11	39 11	18 25	25 25	9 34	11 32	—	—	—	—	—	—	—	—		
160 180	0 - 25	68 18	32 11	39 11	18 25	25 25	9 34	11 32	—	—	—	—	—	—	—	—		
180 200	0 - 30	79 20	35 15	44 15	20 30	29 30	10 40	13 37	—	—	—	—	—	—	—	—		
200 225	0 - 30	79 20	35 15	44 15	20 30	29 30	10 40	13 37	—	—	—	—	—	—	—	—		
225 250	0 - 30	79 20	35 15	44 15	20 30	29 30	10 40	13 37	—	—	—	—	—	—	—	—		
250 280	0 - 35	88 21	40 18	49 18	23 35	32 35	11.5 46.5	16 42	—	—	—	—	—	—	—	—		
280 315	0 - 35	88 21	40 18	49 18	23 35	32 35	11.5 46.5	16 42	—	—	—	—	—	—	—	—		
315 355	0 - 40	98 22	43 22	54 22	25 40	36 40	12.5 52.5	18 47	—	—	—	—	—	—	—	—		
355 400	0 - 40	98 22	43 22	54 22	25 40	36 40	12.5 52.5	18 47	—	—	—	—	—	—	—	—		
400 450	0 - 45	108 23	47 25	60 25	27 45	40 45	13.5 58.5	20 52	—	—	—	—	—	—	—	—		
450 500	0 - 45	108 23	47 25	60 25	27 45	40 45	13.5 58.5	20 52	—	—	—	—	—	—	—	—		

Remarks 1. The figures for tolerance classes where stress caused by the fitting of the shaft and inner ring becomes excessive are omitted.
2. The tolerance range js is now recommended instead of j.

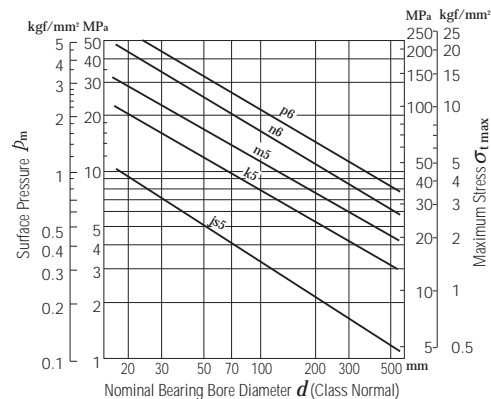

Fig. 15.5 Surface Pressure p_m and Maximum Stress $\sigma_{t \max}$ for Average Fitting Interference

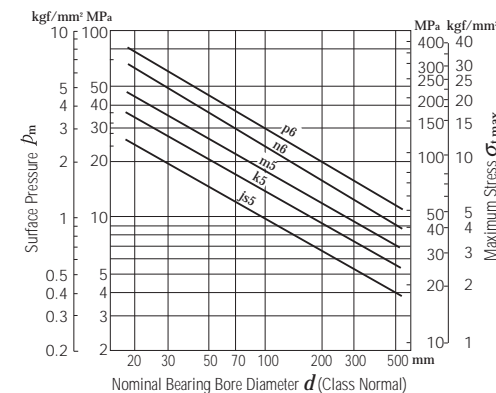

Fig. 15.6 Surface Pressure p_m and Maximum Stress $\sigma_{t \max}$ for Maximum Fitting Interference

of Shafts and Inner Rings

Each Fitting Class																			Size Classification (mm)	
js6		j6		k5		k6		m5		m6		n6		p6		r6		over	incl.	
Clearance	Interference	Clearance	Interference	Interference	Interference	Interference	Interference	Interference	Interference	Interference	Interference	Interference	Interference	Interference	Interference	Interference	Interference			
max.	max.	max.	max.	min.	max.	min.	max.	min.	max.	min.	max.	min.	max.	min.	max.	min.	max.			
—	—	—	—	—	—	—	—	—	—	—	—	—	—	—	—	—	—	3	6	
4.5	12.5	2	15	—	—	—	—	—	—	—	—	—	—	—	—	—	—	6	10	
5.5	13.5	3	16	—	—	—	—	—	—	—	—	—	—	—	—	—	—	10	18	
6.5	16.5	4	19	2	21	2	25	—	—	—	—	—	—	—	—	—	—	18	30	
8	20	5	23	2	25	2	30	9	32	9	37	—	—	—	—	—	—	30	50	
9.5	24.5	7	27	2	30	2	36	11	39	11	45	—	—	—	—	—	—	50	65	
9.5	24.5	7	27	2	30	2	36	11	39	11	45	20	54	—	—	—	—	65	80	
11	31	9	33	3	38	3	45	13	48	13	55	23	65	37	79	—	—	80	100	
11	31	9	33	3	38	3	45	13	48	13	55	23	65	37	79	—	—	100	120	
12.5	37.5	11	39	3	46	3	53	15	58	15	65	27	77	43	93	63	113	120	140	
12.5	37.5	11	39	3	46	3	53	15	58	15	65	27	77	43	93	65	115	140	160	
12.5	37.5	11	39	3	46	3	53	15	58	15	65	27	77	43	93	68	118	160	180	
14.5	44.5	13	46	4	54	4	63	17	67	17	76	31	90	50	109	77	136	180	200	
14.5	44.5	13	46	4	54	4	63	17	67	17	76	31	90	50	109	80	139	200	225	
14.5	44.5	13	46	4	54	4	63	17	67	17	76	31	90	50	109	84	143	225	250	
16	51	16	51	4	62	4	71	20	78	20	87	34	101	56	123	94	161	250	280	
16	51	16	51	4	62	4	71	20	78	20	87	34	101	56	123	98	165	280	315	
18	58	18	58	4	69	4	80	21	86	21	97	37	113	62	138	108	184	315	355	
18	58	18	58	4	69	4	80	21	86	21	97	37	113	62	138	114	190	355	400	
20	65	20	65	5	77	5	90	23	95	23	108	40	125	68	153	126	211	400	450	
20	65	20	65	5	77	5	90	23	95	23	108	40	125	68	153	132	217	450	500	

Table 15. 3 Interferences or

Size Classification (mm)		Single Plane Mean O. D. Deviation (Normal) ΔD_{mp}		Interferences or Clearances for													
				G7		H6		H7		H8		J6		JS6		J7	
				Clearance		Clearance		Clearance		Clearance		Clearance		Interference		Interference	
over	incl.	high	low	max.	min.	max.	min.	max.	min.	max.	min.	max.	max.	min.	max.	max.	min.
6	10	0	- 8	28	5	17	0	23	0	30	0	13	4	12.5	4.5	16	7
10	18	0	- 8	32	6	19	0	26	0	35	0	14	5	13.5	5.5	18	8
18	30	0	- 9	37	7	22	0	30	0	42	0	17	5	15.5	6.5	21	9
30	50	0	- 11	45	9	27	0	36	0	50	0	21	6	19	8	25	11
50	80	0	- 13	53	10	32	0	43	0	59	0	26	6	22.5	9.5	31	12
80	120	0	- 15	62	12	37	0	50	0	69	0	31	6	26	11	37	13
120	150	0	- 18	72	14	43	0	58	0	81	0	36	7	30.5	12.5	44	14
150	180	0	- 25	79	14	50	0	65	0	88	0	43	7	37.5	12.5	51	14
180	250	0	- 30	91	15	59	0	76	0	102	0	52	7	44.5	14.5	60	16
250	315	0	- 35	104	17	67	0	87	0	116	0	60	7	51	16	71	16
315	400	0	- 40	115	18	76	0	97	0	129	0	69	7	58	18	79	18
400	500	0	- 45	128	20	85	0	108	0	142	0	78	7	65	20	88	20
500	630	0	- 50	142	22	94	0	120	0	160	0	—	—	72	22	—	—
630	800	0	- 75	179	24	125	0	155	0	200	0	—	—	100	25	—	—
800	1000	0	-100	216	26	156	0	190	0	240	0	—	—	128	28	—	—

Note (*) Indicates the minimum interference
Remarks The tolerance range JS is now recommended instead of J.

Clearances of Housing Bores and Outer Rings

Units : μm

Each Fitting Class																Size Classification (mm)			
JS7		K6		K7		M6		M7		N6		N7		P6				P7	
Clearance	Interference	Clearance	Interference	Clearance	Interference	Clearance	Interference	Clearance	Interference	Clearance	Interference	Clearance	Interference	Interference	Interference			Interference	Interference
max.	max.	max.	max.	max.	max.	max.	max.	max.	max.	max.	max.	max.	max.	max.	max.	min.	max.	over	incl.
15	7	10	7	13	10	5	12	8	15	1	16	4	19	4	21	1	24	6	10
17	9	10	9	14	12	4	15	8	18	1*	20	3	23	7	26	3	29	10	18
19	10	11	11	15	15	5	17	9	21	2*	24	2	28	9	31	5	35	18	30
23	12	14	13	18	18	7	20	11	25	1*	28	3	33	10	37	6	42	30	50
28	15	17	15	22	21	8	24	13	30	1*	33	4	39	13	45	8	51	50	80
32	17	19	18	25	25	9	28	15	35	1*	38	5	45	15	52	9	59	80	120
38	20	22	21	30	28	10	33	18	40	2*	45	6	52	18	61	10	68	120	150
45	20	29	21	37	28	17	33	25	40	5	45	13	52	11	61	3	68	150	180
53	23	35	24	43	33	22	37	30	46	8	51	16	60	11	70	3	79	180	250
61	26	40	27	51	36	26	41	35	52	10	57	21	66	12	79	1	88	250	315
68	28	47	29	57	40	30	46	40	57	14	62	24	73	11	87	1	98	315	400
76	31	53	32	63	45	35	50	45	63	18	67	28	80	10	95	0	108	400	500
85	35	50	44	50	70	24	70	24	96	6	88	6	114	28	122	28	148	500	630
115	40	75	50	75	80	45	80	45	110	25	100	25	130	13	138	13	168	630	800
145	45	100	56	100	90	66	90	66	124	44	112	44	146	0	156	0	190	800	1000

15.3 Radial and Axial Internal Clearances

Table 15. 4 Constant K

(1) Radial Internal Clearance Δ_r and Axial Internal Clearance Δ_a in Single-Row Deep Groove Ball Bearings (Fig. 15.7)

$$\Delta_a \doteq K \Delta_r^{\frac{1}{2}} \quad (\text{mm})$$

where

$$K = 2 (r_e + r_i - D_w)^{\frac{1}{2}}$$

(2) Radial Internal Clearance Δ_r and Axial Internal Clearance Δ_a in Double-Row Angular Contact Ball Bearings (Fig. 15.8)

$$\Delta_a = 2 \sqrt{m_0^2 - (m_0 \cos \alpha_R - \frac{\Delta_r}{2})^2} - 2 m_0 \sin \alpha_R \quad (\text{mm})$$

Bore No.	Values of K			
	160XX	60XX	62XX	63XX
00	—	—	0.93	1.14
01	0.80	0.80	0.93	1.06
02	0.80	0.93	0.93	1.06
03	0.80	0.93	0.99	1.11
04	0.90	0.96	1.06	1.07
05	0.90	0.96	1.06	1.20
06	0.96	1.01	1.07	1.19
07	0.96	1.06	1.25	1.37
08	0.96	1.06	1.29	1.45
09	1.01	1.11	1.29	1.57
10	1.01	1.11	1.33	1.64
11	1.06	1.20	1.40	1.70
12	1.06	1.20	1.50	2.09
13	1.06	1.20	1.54	1.82
14	1.16	1.29	1.57	1.88
15	1.16	1.29	1.57	1.95
16	1.20	1.37	1.64	2.01
17	1.20	1.37	1.70	2.06
18	1.29	1.44	1.76	2.11
19	1.29	1.44	1.82	2.16
20	1.29	1.44	1.88	2.25
21	1.37	1.54	1.95	2.32
22	1.40	1.64	2.01	2.40
24	1.40	1.64	2.06	2.40
26	1.54	1.70	2.11	2.49
28	1.54	1.70	2.11	2.59
30	1.57	1.76	2.11	2.59

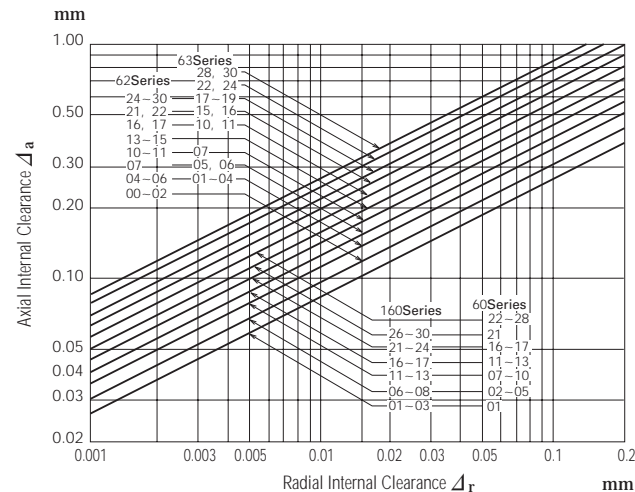

Fig. 15.7 Δ_r and Δ_a in Single-Row Deep Groove Ball Bearings

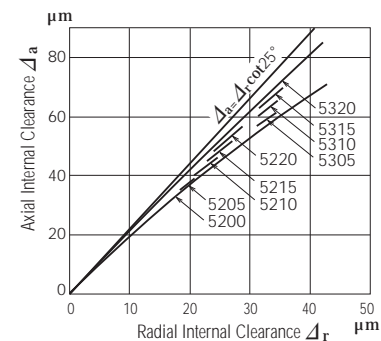

Fig. 15.8 Δ_r and Δ_a in Double-Row Angular Contact Ball Bearings (52, 53 Series)

15. 4 Preload and Starting Torque

(1) Axial Load F_a and Starting Torque M of Tapered Roller Bearings (Figs. 15.9 and 15.10)

$$M = e \mu_e F_a \cos \beta \quad (\text{N}\cdot\text{mm}), \{\text{kgf}\cdot\text{mm}\}$$

where

$$\mu_e : 0.20$$

When bearings with the same number are used in opposition, the torque M caused by the preload becomes $2M$.

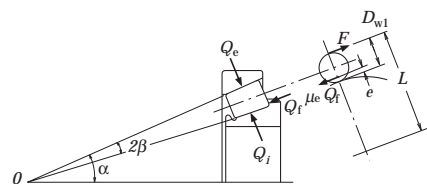

Fig. 15.9 Relation between e and β

(2) Preload F_a and Starting Torque M of Angular Contact Ball Bearings and Double-Direction Angular Contact Thrust Ball Bearings (Figs. 15.11 and 15.12)

$$M = M_s Z \sin \alpha \quad (\text{N}\cdot\text{mm}), \{\text{kgf}\cdot\text{mm}\}$$

where M_s is spin friction

$$M_s = \frac{3}{8} \mu_s Q a E(k) \quad (\text{N}\cdot\text{mm}), \{\text{kgf}\cdot\text{mm}\}$$

where

$$\mu_s = 0.15$$

When bearings with the same number are used in opposition, the torque M caused by the preload becomes $2M$.

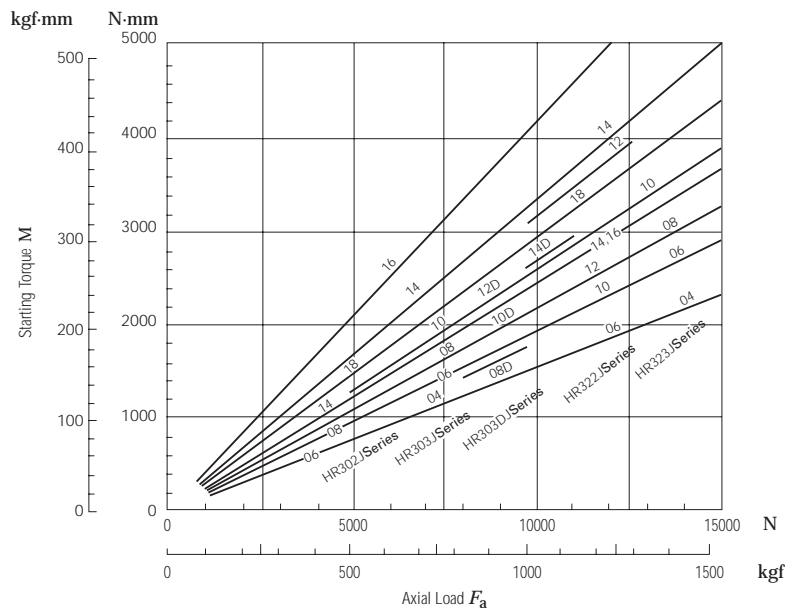

Fig. 15.10 Relation between Axial Load and Starting Torque of Tapered Roller Bearings

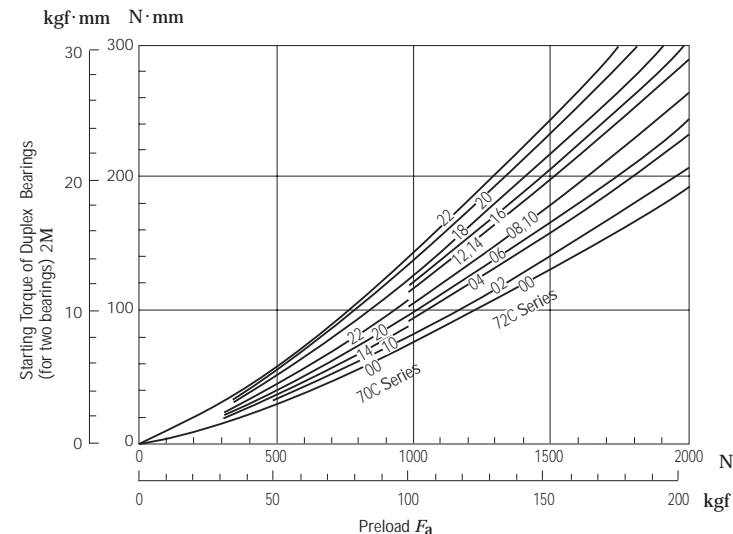

Fig. 15.11 Preload and Starting Torque for Back-to-Back or Face-to-Face Arrangements of Angular Contact Ball Bearings ($\alpha = 15^\circ$)

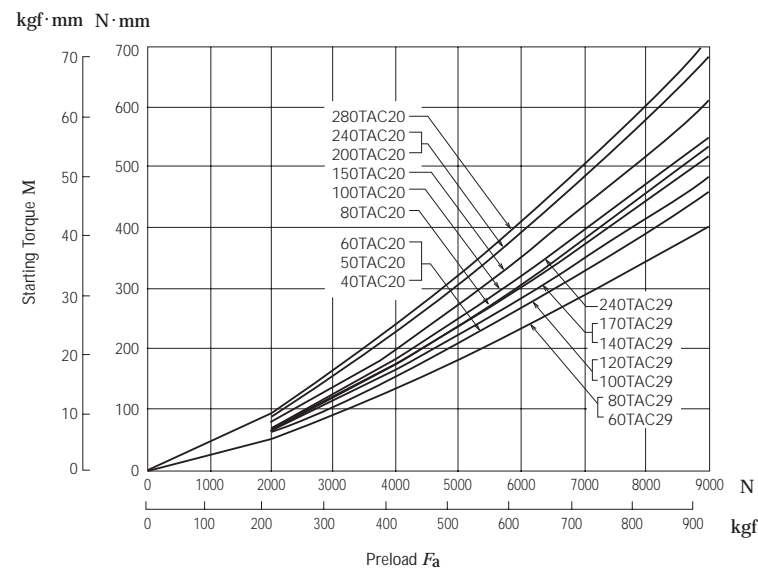

Fig. 15.12 Preload and Starting Torque of Double-Direction Angular Contact Thrust Ball Bearings

15.5 Coefficients of Dynamic Friction and Other Bearing Data

(1) Bearing Types and Their Coefficients of Dynamic Friction μ

$$\mu = \frac{M}{P \cdot \frac{d}{2}}$$

Table 15.5 Coefficients of Dynamic Friction

Bearing Types	Approximate values of μ
Deep Groove Ball Bearings	0.0013
Angular Contact Ball Bearings	0.0015
Self-Aligning Ball Bearings	0.0010
Thrust Ball Bearings	0.0011
Cylindrical Roller Bearings	0.0010
Tapered Roller Bearings	0.0022
Spherical Roller Bearings	0.0028
Needle Roller Bearings with Cages	0.0015
Full Complement Needle Roller Bearings	0.0025
Spherical Thrust Roller Bearings	0.0028

(3) Radial Internal Clearance Δ_r and Fatigue Life L (Fig. 15.13)

For the radial internal clearance Δ_r and the function f (ϵ) of the load factor, the following equations are valid:

For Deep Groove Ball Bearings

$$f(\epsilon) = \frac{\Delta_r \cdot D_w^{\frac{1}{3}}}{0.00044 \left(\frac{F_r}{Z}\right)^{\frac{2}{3}}} \dots\dots\dots (N)$$

$$f(\epsilon) = \frac{\Delta_r \cdot D_w^{\frac{1}{3}}}{0.002 \left(\frac{F_r}{Z}\right)^{\frac{2}{3}}} \dots\dots\dots \{kgf\}$$

For Cylindrical Roller Bearings

$$f(\epsilon) = \frac{\Delta_r \cdot L_{we}^{0.8}}{0.000077 \left(\frac{F_r}{Z}\right)^{0.9}} \dots\dots\dots (N)$$

$$f(\epsilon) = \frac{\Delta_r \cdot L_{we}^{0.8}}{0.0006 \left(\frac{F_r}{Z}\right)^{0.9}} \dots\dots\dots \{kgf\}$$

The relation between the load factor ϵ and $f(\epsilon)$ and L_ϵ/L , when the radial internal clearance is Δ_r is as shown in Table 15.7.

From the above equations, first obtain $f(\epsilon)$ and then ϵ and L_ϵ/L can be obtained.

Table 15.7 ϵ and $f(\epsilon)$, L_ϵ/L

ϵ	Deep Groove Ball Bearings		Cylindrical Roller Bearings	
	$f(\epsilon)$	$\frac{L_\epsilon}{L}$	$f(\epsilon)$	$\frac{L_\epsilon}{L}$
0.1	33.713	0.294	51.315	0.220
0.2	10.221	0.546	14.500	0.469
0.3	4.045	0.737	5.539	0.691
0.4	1.408	0.889	1.887	0.870
0.5	0	1.0	0	1.0
0.6	-0.859	1.069	-1.133	1.075
0.7	-1.438	1.098	-1.897	1.096
0.8	-1.862	1.094	-2.455	1.065
0.9	-2.195	1.041	-2.929	0.968
1.0	-2.489	0.948	-3.453	0.805
1.25	-3.207	0.605	-4.934	0.378
1.5	-3.877	0.371	-6.387	0.196
1.67	-4.283	0.276	-7.335	0.133
1.8	-4.596	0.221	-8.082	0.100
2.0	-5.052	0.159	-9.187	0.067
2.5	-6.114	0.078	-11.904	0.029
3	-7.092	0.043	-14.570	0.015
4	-8.874	0.017	-19.721	0.005
5	-10.489	0.008	-24.903	0.002
10	-17.148	0.001	-48.395	0.0002

(2) Circumferential Speeds of Rolling Elements about Their Centers and Bearing Center

Table 15.6 Circumferential Speeds of Rolling Elements about Their Centers and Bearing Center

Items	Rotating inner ring, fixed outer ring	Rotating outer ring, fixed inner ring
Ball rotating speed n_a (min ⁻¹)	$-\left(\frac{D_{pw}}{D_w} - \frac{\cos^2 \alpha}{D_{pw}/D_w}\right) \frac{n_i}{2}$	$+\left(\frac{D_{pw}}{D_w} - \frac{\cos^2 \alpha}{D_{pw}/D_w}\right) \frac{n_e}{2}$
Circumferential speed around bearing ball's center v_a (m/sec)	$-\frac{\pi \cdot D_w}{60 \times 10^3} \left(\frac{D_{pw}}{D_w} - \frac{\cos^2 \alpha}{D_{pw}/D_w}\right) \frac{n_i}{2}$	$+\frac{\pi \cdot D_w}{60 \times 10^3} \left(\frac{D_{pw}}{D_w} - \frac{\cos^2 \alpha}{D_{pw}/D_w}\right) \frac{n_e}{2}$
Revolving speed around bearing center n_c (min ⁻¹)	$+\left(1 - \frac{\cos \alpha}{D_{pw}/D_w}\right) \frac{n_i}{2}$	$+\left(1 - \frac{\cos \alpha}{D_{pw}/D_w}\right) \frac{n_e}{2}$
Circumferential speed around bearing center v_c (m/sec)	$-\frac{\pi \cdot D_{pw}}{60 \times 10^3} \left(1 - \frac{\cos \alpha}{D_{pw}/D_w}\right) \frac{n_i}{2}$	$+\frac{\pi \cdot D_{pw}}{60 \times 10^3} \left(1 - \frac{\cos \alpha}{D_{pw}/D_w}\right) \frac{n_e}{2}$

Remarks 1. + sign indicates CW rotation and - sign CCW
 2. The revolving speed and circumferential speed of the rolling elements are the same as those of the cage.

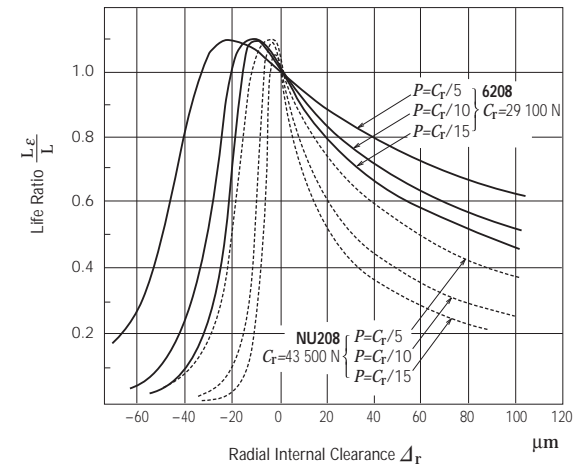

Fig. 15.13 Radial Internal Clearance and Life Ratio

15. 6 BRANDS AND PROPERTIES OF LUBRICATING GREASES

Table 15. 8 Brands of Lubricating Greases

Brands	Thickeners	Base Oils
ADLEX	Lithium	Mineral oil
APOILOIL AUTOLEX A	Lithium	Mineral oil
ARAPEN RB 300	Lithium/Calcium	Mineral oil
EA2 GREASE	Urea (1)	Poly- α -olefin oil
EA3 GREASE	Urea (1)	Poly- α -olefin oil
EA5 GREASE	Urea (1)	Poly- α -olefin oil
EA7 GREASE	Urea (1)	Poly- α -olefin oil
ENC GREASE	Urea (1)	Polyol ester oil + Mineral oil (4)
ENS GREASE	Urea (1)	Polyol ester oil (4)
ECE GREASE	Lithium	Poly- α -olefin oil
ISOFLEX NBU 15	Barium Complex	Ester oil + Mineral oil (4)
ISOFLEX SUPER LDS 18	Lithium	Ester oil (4)
ISOFLEX TOPAS NB 52	Barium Complex	Poly- α -olefin oil
DOW CORNING SH 33 L GREASE	Lithium	Silicone oil (5)
DOW CORNING SH 44 M GREASE	Lithium	Silicone oil (5)
NS HI-LUBE	Lithium	Polyol ester oil + Diester oil (4)
NSC GREASE	Lithium	Alkyldiphenyl ether oil + Polyol ester oil (4)
NSK CLEAN GREASE LG2	Lithium	Poly- α -olefin oil + Mineral oil
EMALUBE 8030	Urea (1)	Mineral oil
MAB GREASE	Urea (1)	Alkyldiphenyl ether oil + Poly- α -olefin oil
KRYTOX GPL-524	PTFE	Perfluoropolyether oil
KP1 GREASE	PTFE	Perfluoropolyether oil
COSMO WIDE GREASE WR No.3N	Sodium Terephthalamate	Polyol ester oil + Mineral oil (4)
G-40M	Lithium	Silicone oil (5)
SHELL GADUS S2 V220 2	Lithium	Mineral oil
SHELL ALVANIA GREASE S1	Lithium	Mineral oil
SHELL ALVANIA GREASE S2	Lithium	Mineral oil
SHELL ALVANIA GREASE S3	Lithium	Mineral oil
CASSIDA GREASE RLS 2	Aluminum Complex	Poly- α -olefin oil
SHELL SUNLIGHT GREASE 2	Lithium	Mineral oil
WPH GREASE	Urea (1)	Poly- α -olefin oil
DEMNUM GREASE L-200	PTFE	Perfluoropolyether oil
NIGACE WR-S	Urea (1)	Synthetic oil
NIGLUBE RSH	Sodium Complex	Polyalkylene Glycol oil

- Notes**
- (1) If grease will be used at the upper or lower limit sufficient of the temperature range or in a special environment such as vacuum, it is advisable to consult NSK.
 - (2) For short-term operation or when cooling is grease may be used at speeds exceeding the above limits provided the supply of grease is appropriate.
 - (3) Urea-based grease causes fluorine-based material to deteriorate.
 - (4) Ester-based grease causes acrylic rubber material to swell.
 - (5) Silicone-based grease causes silicone-based material to swell.

and Comparison of Properties

Dropping Point (°C)	Consistency	Working Temperature Range(1)(°C)	Pressure Resistance	Usable Limit Compared to Listed Limiting Speed(2)(%)
198	300	0 to +110	Good	70
198	280	-10 to +110	Fair	60
177	294	-10 to + 80	Fair	70
≥ 260	243	-40 to +150	Fair	100
≥ 260	230	-40 to +150	Fair	100
≥ 260	251	-40 to +160	Good	60
≥ 260	243	-40 to +160	Fair	100
≥ 260	262	-40 to +160	Fair	70
≥ 260	264	-40 to +160	Poor	100
≥ 260	235	-10 to +120	Fair	100
≥ 260	280	-30 to +120	Poor	100
195	280	-50 to +110	Poor	100
≥ 260	280	-40 to +130	Poor	90
210	310	-60 to +120	Poor	60
210	260	-30 to +130	Poor	60
192	250	-40 to +130	Fair	100
192	235	-30 to +140	Fair	70
201	199	-40 to +130	Poor	100
≥ 260	280	0 to +130	Good	60
≥ 260	283	-30 to +160	Fair	70
≥ 260	265	0 to +200	Fair	70
≥ 260	280	-30 to +200	Fair	60
≥ 230	227	-40 to +130	Poor	100
223	252	-30 to +130	Poor	60
187	276	0 to + 80	Good	60
182	323	-10 to +110	Fair	70
185	275	-10 to +110	Fair	70
185	242	-10 to +110	Fair	70
≥ 240	280	0 to +120	Fair	70
200	274	-10 to +110	Fair	70
259	240	-40 to +150	Fair	70
≥ 260	280	-30 to +200	Fair	60
≥ 260	230	-30 to +150	Poor	70
≥ 260	270	-20 to +120	Fair	60

(continued on next page)

Brands	Thickeners	Base Oils
PALMAX RBG	Lithium Complex	Mineral oil
BEACON 325	Lithium	Diester oil ^(*)
MULTEMP PS No.2	Lithium	Poly- α -olefin oil + Diester oil ^(*)
MOLYKOTE FS-3451 GREASE	PTFE	Fluorosilicone oil ^(*)
UME GREASE	Urea	Mineral oil
RAREMAX AF-1	Urea	Mineral oil

- Notes**
- (1) If grease will be used at the upper or lower limit sufficient of the temperature range or in a special environment such as vacuum, it is advisable to consult NSK.
 - (2) For short-term operation or when cooling is grease may be used at speeds exceeding the above limits provided the supply of grease is appropriate.
 - (3) Urea-based grease causes fluorine-based material to deteriorate.
 - (4) Ester-based grease causes acrylic rubber material to swell.
 - (5) Silicone-based grease causes silicone-based material to swell.

Dropping Point (°C)	Consistency	Working Temperature Range ⁽¹⁾ (°C)	Pressure Resistance	Usable Limit Compared to Listed Limiting Speed ⁽²⁾ (%)
216	300	-10 to +130	Good	70
190	274	-50 to +100	Poor	100
190	275	-50 to +110	Poor	100
≥ 260	285	0 to +180	Fair	70
≥ 260	268	-10 to +130	Fair	70
≥ 260	300	-10 to +130	Fair	70

BEARING TABLES

DEEP GROOVE BALL BEARINGS

SINGLE-ROW DEEP GROOVE BALL BEARINGS

Open Type, Shielded Type, Sealed Type Bore Diameter 10 – 240mm..... B8
 Open Type Bore Diameter 260 – 800mm..... B20

MAXIMUM TYPE BALL BEARINGS Bore Diameter 25 – 110mm B26

MAGNETO BEARINGS Bore Diameter 4 – 20mm..... B28

Extra Small and Miniature Ball Bearings are described on Pages B30 to B45.

DESIGN, TYPES, AND FEATURES

SINGLE-ROW DEEP GROOVE BALL BEARINGS

Single-Row Deep Groove Ball Bearings are classified into the types shown below.

The proper amount of good quality grease is packed in shielded and sealed ball bearings. A comparison of the features of each type is shown in Table 1.



Table 1 Features of Sealed Ball Bearings

Type	Shielded Type (ZZ Type)	Non-Contact Rubber Sealed Type (VV Type)	Contact Rubber Sealed Type (DDU Type)
Torque	Low	Low	Higher than ZZ, VV types due to contact seal
Speed capability	Good	Good	Limited by contact seals
Grease sealing effectiveness	Good	Better than ZZ type	A little better than VV type
Dust resistance	Good	Better than ZZ type (usable in moderately dusty environment)	Best (usable even in very dusty environment)
Water resistance	Not suitable	Not suitable	Good (usable even if fluid is splashed on bearing)
Operating temperature (1)	-10 to +110°C	-10 to +110°C	-10 to +100°C

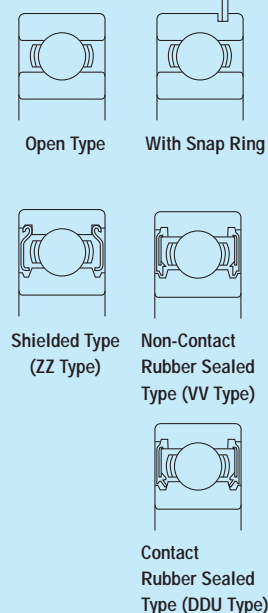

Note (1) The above temperature range applies to standard bearings. By using cold or heat resistant grease and changing the type of rubber, the operating temperature range can be extended. For such applications, please contact NSK.

For deep groove ball bearings, pressed cages are usually used. For big bearings, machined brass cages are used. (Refer to Table 2)

Machined cages are also used for high speed applications.

Table 2 Standard Cages for Deep Groove Ball Bearings

Series	Pressed Steel Cages	Machined Brass Cages
68	6800 – 6838	6840 – 68/800
69	6900 – 6936	6938 – 69/800
160	16001 – 16026	16028 – 16064
60	6000 – 6040	6044 – 60/670
62	6200 – 6240	6244 – 6272
63	6300 – 6332	6334 – 6356

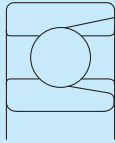

MAXIMUM TYPE BALL BEARINGS

Maximum Type Ball Bearings contain a larger number of balls than normal deep groove ball bearings because of filling slots in the inner and outer rings. Because of their filling slots, they are not suitable for applications with high axial loads.

BL2 and BL3 types of bearings have boundary dimensions equal to those of single-row deep groove ball bearings of Series 62 and 63 respectively. Besides the open type, ZZ type shielded bearings are also available.

When using these bearings, it is important for the filling slot in the outer ring to be outside of the loaded zone as much as possible.

Their cages are pressed steel.

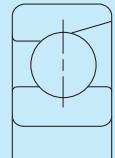

MAGNETO BEARINGS

The groove in the inner ring is a little shallower than that of deep groove ball bearings and one side of the outer ring is relieved. Consequently, the outer ring is separable, which makes it convenient for mounting.

Pressed cages are standard, but for high speed applications, machined synthetic resin cages are used.

PRECAUTIONS FOR USE OF DEEP GROOVE BALL BEARINGS

For deep groove ball bearings, if the bearing load is too small during operation, slippage occurs between the balls and raceways, which may result in smearing. The higher the weight of balls and cage, the higher this tendency becomes, especially for large bearings. If very small bearing loads are expected, please contact NSK for selection of an appropriate bearing.

TOLERANCES AND RUNNING ACCURACY

SINGLE-ROW DEEP GROOVE BALL BEARINGS Table 8.2 (Pages A60 to A63)
 MAXIMUM TYPE BALL BEARINGS Table 8.2 (Pages A60 to A63)
 MAGNETO BEARINGS Table 8.5 (Pages A70 and A71)

RECOMMENDED FITS

SINGLE-ROW DEEP GROOVE BALL BEARINGS Table 9.2 (Page A84)
 Table 9.4 (Page A85)
 MAXIMUM TYPE BALL BEARINGS Table 9.2 (Page A84)
 Table 9.4 (Page A85)
 MAGNETO BEARINGS Table 9.2 (Page A84)
 Table 9.4 (Page A85)

INTERNAL CLEARANCES

SINGLE-ROW DEEP GROOVE BALL BEARINGS Table 9.9 (Page A89)
 MAXIMUM TYPE BALL BEARINGS Table 9.9 (Page A89)
 MAGNETO BEARINGS Table 9.11 (Page A89)

LIMITING SPEEDS

The limiting speeds listed in the bearing tables should be adjusted depending on the bearing load conditions. Also, higher speeds are attainable by making changes in the lubrication method, cage design, etc. Refer to Page A37 for detailed information.

SINGLE-ROW DEEP GROOVE BALL BEARINGS

Bore Diameter 10 – 22 mm

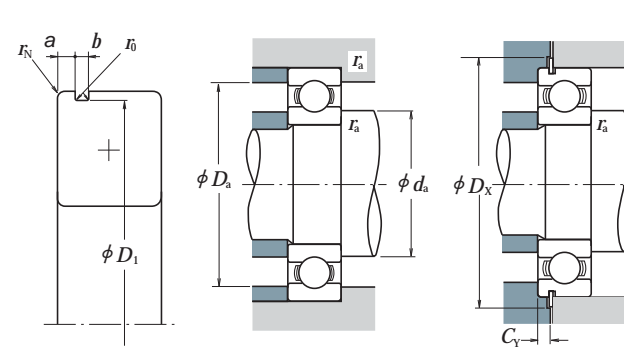
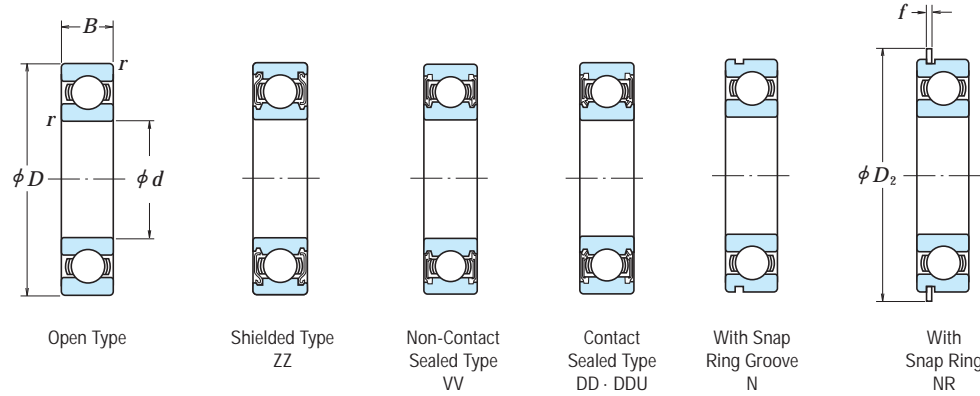

Dynamic Equivalent Load

$$P = XF_r + YF_a$$

$\frac{f_0 F_a}{C_{0r}}$	e	$\frac{F_a}{F_r} \leq e$		$\frac{F_a}{F_r} > e$	
		X	Y	X	Y
0.172	0.19	1	0	0.56	2.30
0.345	0.22	1	0	0.56	1.99
0.689	0.26	1	0	0.56	1.71
1.03	0.28	1	0	0.56	1.55
1.38	0.30	1	0	0.56	1.45
2.07	0.34	1	0	0.56	1.31
3.45	0.38	1	0	0.56	1.15
5.17	0.42	1	0	0.56	1.04
6.89	0.44	1	0	0.56	1.00

Static Equivalent Load

$$\frac{F_a}{F_r} > 0.8, P_0 = 0.6F_r + 0.5F_a$$

$$\frac{F_a}{F_r} \leq 0.8, P_0 = F_r$$

Boundary Dimensions (mm)	Basic Load Ratings (N)				Factor f_0	Limiting Speeds (min ⁻¹)			Bearing Numbers						
	C_r	C_{0r}	(kgf)			Grease		Oil	Open	Shielded	Sealed				
			C_r	C_{0r}		Open Z · ZZ · V · VV	DU · DDU					Open Z			
10	19	5	0.3	1 720	840	175	86	14.8	34 000	24 000	40 000	6800	ZZ	VV	DD
	22	6	0.3	2 700	1 270	275	129	14.0	32 000	22 000	38 000	6900	ZZ	VV	DD
	26	8	0.3	4 550	1 970	465	201	12.4	30 000	22 000	36 000	6000	ZZ	VV	DDU
	30	9	0.6	5 100	2 390	520	244	13.2	24 000	18 000	30 000	6200	ZZ	VV	DDU
	35	11	0.6	8 100	3 450	825	350	11.2	22 000	17 000	26 000	6300	ZZ	VV	DDU
12	21	5	0.3	1 920	1 040	195	106	15.3	32 000	20 000	38 000	6801	ZZ	VV	DD
	24	6	0.3	2 890	1 460	295	149	14.5	30 000	20 000	36 000	6901	ZZ	VV	DD
	28	7	0.3	5 100	2 370	520	241	13.0	28 000	—	32 000	16001	—	—	—
	28	8	0.3	5 100	2 370	520	241	13.0	28 000	18 000	32 000	6201	ZZ	VV	DDU
	32	10	0.6	6 800	3 050	695	310	12.3	22 000	17 000	28 000	6001	ZZ	VV	DDU
	37	12	1	9 700	4 200	990	425	11.1	20 000	16 000	24 000	6301	ZZ	VV	DDU
15	24	5	0.3	2 070	1 260	212	128	15.8	28 000	17 000	34 000	6802	ZZ	VV	DD
	28	7	0.3	4 350	2 260	440	230	14.3	26 000	17 000	30 000	6902	ZZ	VV	DD
	32	8	0.3	5 600	2 830	570	289	13.9	24 000	—	28 000	16002	—	—	—
	32	9	0.3	5 600	2 830	570	289	13.9	24 000	15 000	28 000	6002	ZZ	VV	DDU
	35	11	0.6	7 650	3 750	780	380	13.2	20 000	14 000	24 000	6202	ZZ	VV	DDU
	42	13	1	11 400	5 450	1 170	555	12.3	17 000	13 000	20 000	6302	ZZ	VV	DDU
17	26	5	0.3	2 630	1 570	268	160	15.7	26 000	15 000	30 000	6803	ZZ	VV	DD
	30	7	0.3	4 600	2 550	470	260	14.7	24 000	15 000	28 000	6903	ZZ	VV	DDU
	35	8	0.3	6 000	3 250	610	330	14.4	22 000	—	26 000	16003	—	—	—
	35	10	0.3	6 000	3 250	610	330	14.4	22 000	13 000	26 000	6003	ZZ	VV	DDU
	40	12	0.6	9 550	4 800	975	490	13.2	17 000	12 000	20 000	6203	ZZ	VV	DDU
	47	14	1	13 600	6 650	1 390	675	12.4	15 000	11 000	18 000	6303	ZZ	VV	DDU
20	32	7	0.3	4 000	2 470	410	252	15.5	22 000	13 000	26 000	6804	ZZ	VV	DD
	37	9	0.3	6 400	3 700	650	375	14.7	19 000	12 000	22 000	6904	ZZ	VV	DDU
	42	8	0.3	7 900	4 450	810	455	14.5	18 000	—	20 000	16004	—	—	—
	42	12	0.6	9 400	5 000	955	510	13.8	18 000	11 000	20 000	6004	ZZ	VV	DDU
	47	14	1	12 800	6 600	1 300	670	13.1	15 000	11 000	18 000	6204	ZZ	VV	DDU
	52	15	1.1	15 900	7 900	1 620	805	12.4	14 000	10 000	17 000	6304	ZZ	VV	DDU
22	44	12	0.6	9 400	5 050	960	515	14.0	17 000	11 000	20 000	60/22	ZZ	VV	DDU
	50	14	1	12 900	6 800	1 320	695	13.5	14 000	9 500	16 000	62/22	ZZ	VV	DDU
	56	16	1.1	18 400	9 250	1 870	940	12.4	13 000	9 500	16 000	63/22	ZZ	VV	DDU

With Snap Ring Groove	With Snap Ring	Snap Ring Groove Dimensions (1) (mm)					Snap Ring (1) Dimensions (mm)		Abutment and Fillet Dimensions (mm)					Mass (kg) approx.	
		a max.	b min.	D ₁ max.	r ₀ max.	r _N min.	D ₂ max.	f max.	d _a (2) min.	d _a (2) max.	D _a (2) max.	r _a max.	D _x min.		C _Y max.
—	—	—	—	—	—	—	—	12	12	17	0.3	—	—	0.005	
N(3)	NR(3)	1.05	0.8	20.8	0.2	0.2	24.8	0.7	12	12.5	20	0.3	25.5	1.5	0.009
N(4)	NR(4)	1.35	0.87	24.5	0.2	0.3	28.7	0.84	12	13	24	0.3	29.4	1.9	0.018
N	NR	2.06	1.35	28.17	0.4	0.5	34.7	1.12	14	16	26	0.6	35.5	2.9	0.032
N	NR	2.06	1.35	33.17	0.4	0.5	39.7	1.12	14	16.5	31	0.6	40.5	2.9	0.052
—	—	—	—	—	—	—	—	—	14	14	19	0.3	—	—	0.006
N(3)	NR(3)	1.05	0.8	22.8	0.2	0.2	26.8	0.7	14	14.5	22	0.3	27.5	1.5	0.010
—	—	—	—	—	—	—	—	—	14	—	26	0.3	—	—	0.019
N(4)	NR(4)	1.35	0.87	26.5	0.2	0.3	30.7	0.84	14	15.5	26	0.3	31.4	1.9	0.022
N	NR	2.06	1.35	30.15	0.4	0.5	36.7	1.12	16	17	28	0.6	37.5	2.9	0.037
N	NR	2.06	1.35	34.77	0.4	0.5	41.3	1.12	17	18	32	1	42	2.9	0.060
—	—	—	—	—	—	—	—	—	17	17	22	0.3	—	—	0.007
N(3)	NR(3)	1.3	0.95	26.7	0.25	0.3	30.8	0.85	17	17	26	0.3	31.5	1.8	0.015
—	—	—	—	—	—	—	—	—	17	—	30	0.3	—	—	0.027
N	NR	2.06	1.35	30.15	0.4	0.3	36.7	1.12	17	19	30	0.3	37.5	2.9	0.031
N	NR	2.06	1.35	33.17	0.4	0.5	39.7	1.12	19	20.5	31	0.6	40.5	2.9	0.045
N	NR	2.06	1.35	39.75	0.4	0.5	46.3	1.12	20	22.5	37	1	47	2.9	0.083
—	—	—	—	—	—	—	—	—	19	19	24	0.3	—	—	0.007
N(3)	NR(3)	1.3	0.95	28.7	0.25	0.3	32.8	0.85	19	19.5	28	0.3	33.5	1.8	0.017
—	—	—	—	—	—	—	—	—	19	—	33	0.3	—	—	0.033
N	NR	2.06	1.35	33.17	0.4	0.3	39.7	1.12	19	21.5	33	0.3	40.5	2.9	0.041
N	NR	2.06	1.35	38.1	0.4	0.5	44.6	1.12	21	23.5	36	0.6	45.5	2.9	0.067
N	NR	2.46	1.35	44.6	0.4	0.5	52.7	1.12	22	25.5	42	1	53.5	3.3	0.113
—	—	—	—	—	—	—	—	—	22	22	30	0.3	35.5	1.8	0.017
N	NR	1.3	0.95	30.7	0.25	0.3	34.8	0.85	22	22	30	0.3	35.5	1.8	0.017
N	NR	1.7	0.95	35.7	0.25	0.3	39.8	0.85	22	24	35	0.3	40.5	2.3	0.037
—	—	—	—	—	—	—	—	—	22	—	40	0.3	—	—	0.048
N	NR	2.06	1.35	39.75	0.4	0.5	46.3	1.12	24	25.5	38	0.6	47	2.9	0.068
N	NR	2.46	1.35	44.6	0.4	0.5	52.7	1.12	25	26.5	42	1	53.5	3.3	0.107
N	NR	2.46	1.35	49.73	0.4	0.5	57.9	1.12	26.5	28	45.5	1	58.5	3.3	0.145
N	NR	2.06	1.35	41.75	0.4	0.5	48.3	1.12	26	26.5	40	0.6	49	2.9	0.074
N	NR	2.46	1.35	47.6	0.4	0.5	55.7	1.12	27	29.5	45	1	56.5	3.3	0.119
N	NR	2.46	1.35	53.6	0.4	0.5	61.7	1.12	28.5	30.5	49.5	1	62.5	3.3	0.179

- Notes** (1) For tolerances for the snap ring grooves and snap ring dimensions, refer to Pages A50 to A53.
 (2) When heavy axial loads are applied, increase d_a and decrease D_a from the above values.
 (3) Ring types N and NR applicable only to open-type bearings. Please consult NSK about the snap ring groove dimensions of sealed or shielded bearings.
 (4) Snap ring groove dimensions and snap ring dimensions are not conformed to ISO15.

- Remarks** 1. Diameter Series 7 (extra thin section bearings) are also available, please contact NSK.
 2. When using bearings with rotating outer rings, contact NSK if they are sealed, shielded, or have snap rings.

SINGLE-ROW DEEP GROOVE BALL BEARINGS

Bore Diameter 25 – 45 mm

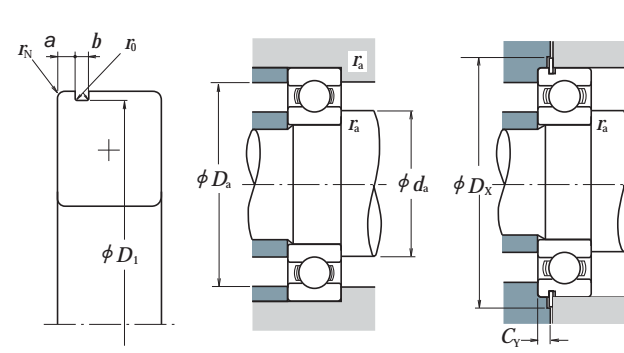
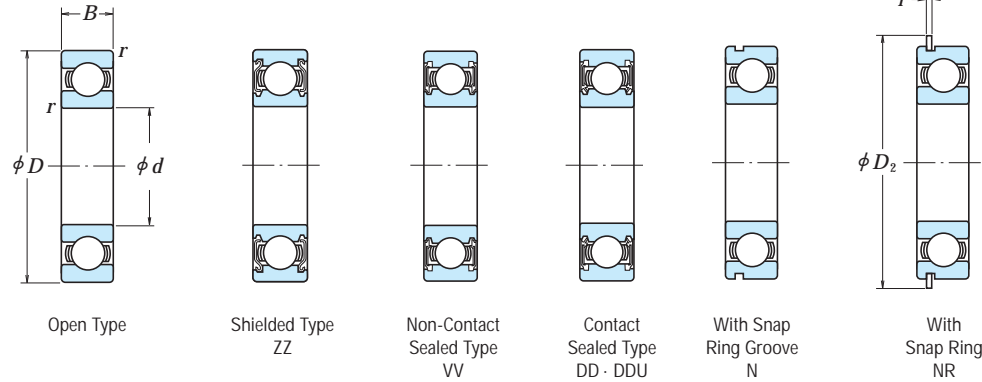

Dynamic Equivalent Load

$$P = XF_r + YF_a$$

$\frac{f_0 F_a}{C_{0r}}$	e	$\frac{F_a}{F_r} \leq e$		$\frac{F_a}{F_r} > e$	
		X	Y	X	Y
0.172	0.19	1	0	0.56	2.30
0.345	0.22	1	0	0.56	1.99
0.689	0.26	1	0	0.56	1.71
1.03	0.28	1	0	0.56	1.55
1.38	0.30	1	0	0.56	1.45
2.07	0.34	1	0	0.56	1.31
3.45	0.38	1	0	0.56	1.15
5.17	0.42	1	0	0.56	1.04
6.89	0.44	1	0	0.56	1.00

Static Equivalent Load

$$\frac{F_a}{F_r} > 0.8, P_0 = 0.6F_r + 0.5F_a$$

$$\frac{F_a}{F_r} \leq 0.8, P_0 = F_r$$

Boundary Dimensions (mm)	Basic Load Ratings (N)				Factor f_0	Limiting Speeds (min ⁻¹)			Bearing Numbers						
	d	D	B	r min.		Grease		Oil	Open	Shielded	Sealed				
						Open Z · ZZ	DU DDU					Open Z			
25	37	7	0.3	4 500	3 150	455	320	16.1	18 000	10 000	22 000	6805	ZZ	VV	DD
	42	9	0.3	7 050	4 550	715	460	15.4	16 000	10 000	19 000	6905	ZZ	VV	DDU
	47	8	0.3	8 850	5 600	905	570	15.1	15 000	—	18 000	16005	—	—	—
28	47	12	0.6	10 100	5 850	1 030	595	14.5	15 000	9 500	18 000	6005	ZZ	VV	DDU
	52	15	1	14 000	7 850	1 430	800	13.9	13 000	9 000	15 000	6205	ZZ	VV	DDU
	62	17	1.1	20 600	11 200	2 100	1 150	13.2	11 000	8 000	13 000	6305	ZZ	VV	DDU
30	42	7	0.3	4 700	3 650	480	370	16.4	15 000	9 000	18 000	6806	ZZ	VV	DD
	47	9	0.3	7 250	5 000	740	510	15.8	14 000	8 500	17 000	6906	ZZ	VV	DDU
	55	9	0.3	11 200	7 350	1 150	750	15.2	13 000	—	15 000	16006	—	—	—
32	55	13	1	13 200	8 300	1 350	845	14.7	13 000	8 000	15 000	6006	ZZ	VV	DDU
	62	16	1	19 500	11 300	1 980	1 150	13.8	11 000	7 500	13 000	6206	ZZ	VV	DDU
	72	19	1.1	26 700	15 000	2 720	1 530	13.3	9 500	6 700	12 000	6306	ZZ	VV	DDU
35	58	13	1	15 100	9 150	1 530	935	14.5	12 000	7 500	14 000	60/32	ZZ	VV	DDU
	65	17	1	20 700	11 600	2 120	1 190	13.6	10 000	7 100	12 000	62/32	ZZ	VV	DDU
	75	20	1.1	29 900	17 000	3 050	1 730	13.2	9 000	6 300	11 000	63/32	ZZ	VV	DDU
40	47	7	0.3	4 900	4 100	500	420	16.7	14 000	7 500	16 000	6807	ZZ	VV	DD
	55	10	0.6	10 600	7 250	1 080	740	15.5	12 000	7 500	15 000	6907	ZZ	VV	DDU
	62	9	0.3	11 700	8 200	1 190	835	15.6	11 000	—	13 000	16007	—	—	—
45	62	14	1	16 000	10 300	1 630	1 050	14.8	11 000	6 700	13 000	6007	ZZ	VV	DDU
	72	17	1.1	25 700	15 300	2 620	1 560	13.8	9 500	6 300	11 000	6207	ZZ	VV	DDU
	80	21	1.5	33 500	19 200	3 400	1 960	13.2	8 500	6 000	10 000	6307	ZZ	VV	DDU
50	52	7	0.3	6 350	5 550	650	565	17.0	12 000	6 700	14 000	6808	ZZ	VV	DD
	62	12	0.6	13 700	10 000	1 390	1 020	15.7	11 000	6 300	13 000	6908	ZZ	VV	DDU
	68	9	0.3	12 600	9 650	1 290	985	16.0	10 000	—	12 000	16008	—	—	—
55	68	15	1	16 800	11 500	1 710	1 180	15.3	10 000	6 000	12 000	6008	ZZ	VV	DDU
	80	18	1.1	29 100	17 900	2 970	1 820	14.0	8 500	5 600	10 000	6208	ZZ	VV	DDU
	90	23	1.5	40 500	24 000	4 150	2 450	13.2	7 500	5 300	9 000	6308	ZZ	VV	DDU
60	58	7	0.3	6 600	6 150	670	625	17.2	11 000	6 000	13 000	6809	ZZ	VV	DD
	68	12	0.6	14 100	10 900	1 440	1 110	15.9	9 500	5 600	12 000	6909	ZZ	VV	DDU
	75	10	0.6	14 900	11 400	1 520	1 160	15.9	9 000	—	11 000	16009	—	—	—
65	75	16	1	20 900	15 200	2 140	1 550	15.3	9 000	5 300	11 000	6009	ZZ	VV	DDU
	85	19	1.1	31 500	20 400	3 200	2 080	14.4	7 500	5 300	9 000	6209	ZZ	VV	DDU
	100	25	1.5	53 000	32 000	5 400	3 250	13.1	6 700	4 800	8 000	6309	ZZ	VV	DDU

With Snap Ring Groove	With Snap Ring	Snap Ring Groove Dimensions (1) (mm)					Snap Ring (1) Dimensions (mm)		Abutment and Fillet Dimensions (mm)					Mass (kg) approx.	
		a max.	b min.	D1 max.	r0 max.	rN min.	D2 max.	f max.	da(2) min.	Da(2) max.	ra max.	Dx min.	Cy max.		
N	NR	1.3	0.95	35.7	0.25	0.3	39.8	0.85	27	27	35	0.3	40.5	1.8	0.021
N(3)	NR(3)	1.7	0.95	40.7	0.25	0.3	44.8	0.85	27	28.5	40	0.3	45.5	2.3	0.042
—	—	—	—	—	—	—	—	—	27	—	45	0.3	—	—	0.059
N	NR	2.06	1.35	44.6	0.4	0.5	52.7	1.12	29	30	43	0.6	53.5	2.9	0.079
N	NR	2.46	1.35	49.73	0.4	0.5	57.9	1.12	30	32	47	1	58.5	3.3	0.129
N	NR	3.28	1.9	59.61	0.6	0.5	67.7	1.7	31.5	36	55.5	1	68.5	4.6	0.235
N	NR	2.06	1.35	49.73	0.4	0.5	57.9	1.12	32	34	48	0.6	58.5	2.9	0.096
N	NR	2.46	1.35	55.6	0.4	0.5	63.7	1.12	33	35.5	53	1	64.5	3.3	0.175
N	NR	3.28	1.9	64.82	0.6	0.5	74.6	1.7	34.5	38	61.5	1	76	4.6	0.287
N	NR	1.3	0.95	40.7	0.25	0.3	44.8	0.85	32	32	40	0.3	45.5	1.8	0.024
N	NR	1.7	0.95	45.7	0.25	0.3	49.8	0.85	32	34	45	0.3	50.5	2.3	0.052
—	—	—	—	—	—	—	—	—	32	—	53	0.3	—	—	0.087
N	NR	2.08	1.35	52.6	0.4	0.5	60.7	1.12	35	36.5	50	1	61.5	2.9	0.116
N	NR	3.28	1.9	59.61	0.6	0.5	67.7	1.7	35	38.5	57	1	68.5	4.6	0.199
N	NR	3.28	1.9	68.81	0.6	0.5	78.6	1.7	36.5	42.5	65.5	1	80	4.6	0.345
N	NR	2.08	1.35	55.6	0.4	0.5	63.7	1.12	37	38.5	53	1	64.5	2.9	0.122
N	NR	3.28	1.9	62.6	0.6	0.5	70.7	1.7	37	40	60	1	71.5	4.6	0.225
N	NR	3.28	1.9	71.83	0.6	0.5	81.6	1.7	38.5	44.5	68.5	1	83	4.6	0.389
N	NR	1.3	0.95	45.7	0.25	0.3	49.8	0.85	37	37	45	0.3	50.5	1.8	0.027
N	NR	1.7	0.95	53.7	0.25	0.5	57.8	0.85	39	39	51	0.6	58.5	2.3	0.075
—	—	—	—	—	—	—	—	—	37	—	60	0.3	—	—	0.107
N	NR	2.08	1.9	59.61	0.6	0.5	67.7	1.7	40	41.5	57	1	68.5	3.4	0.151
N	NR	3.28	1.9	68.81	0.6	0.5	78.6	1.7	41.5	44.5	65.5	1	80	4.6	0.284
N	NR	3.28	1.9	76.81	0.6	0.5	86.6	1.7	43	47	72	1.5	88	4.6	0.464
N	NR	1.3	0.95	50.7	0.25	0.3	54.8	0.85	42	42	50	0.3	55.5	1.8	0.031
N	NR	1.7	0.95	60.7	0.25	0.5	64.8	0.85	44	46	58	0.6	65.5	2.3	0.112
—	—	—	—	—	—	—	—	—	42	—	66	0.3	—	—	0.13
N	NR	2.49	1.9	64.82	0.6	0.5	74.6	1.7	45	47.5	63	1	76	3.8	0.19
N	NR	3.28	1.9	76.81	0.6	0.5	86.6	1.7	46.5	50.5	73.5	1	88	4.6	0.366
N	NR	3.28	2.7	86.79	0.6	0.5	96.5	2.46	48	53	82	1.5	98	5.4	0.636
N	NR	1.3	0.95	56.7	0.25	0.3	60.8	0.85	47	47.5	56	0.3	61.5	1.8	0.038
N	NR	1.7	0.95	66.7	0.25	0.3(4)	70.8	0.85	49	50	64	0.6	72	2.3	0.126
—	—	—	—	—	—	—	—	—	49	—	71	0.6	—	—	0.167
N	NR	2.49	1.9	71.83	0.6	0.5	81.6	1.7	50	53.5	70	1	83	3.8	0.241
N	NR	3.28	1.9	81.81	0.6	0.5	91.6	1.7	51.5	55.5	78.5	1	93	4.6	0.42
N	NR	3.28	2.7	96.8	0.6	0.5	106.5	2.46	53	61.5	92	1.5	108	5.4	0.829

- Notes (1) For tolerances for the snap ring grooves and snap ring dimensions, refer to Pages A50 to A53.
 (2) When heavy axial loads are applied, increase d_a and decrease D_a from the above values.
 (3) Ring types N and NR applicable only to open-type bearings. Please consult NSK about the snap ring groove dimensions of sealed or shielded bearings.

- Remarks 1. Diameter Series 7 (extra thin section bearings) are also available, please contact NSK.
 2. When using bearings with rotating outer rings, contact NSK if they are sealed, shielded, or have snap rings.

SINGLE-ROW DEEP GROOVE BALL BEARINGS

Bore Diameter 50 – 75 mm

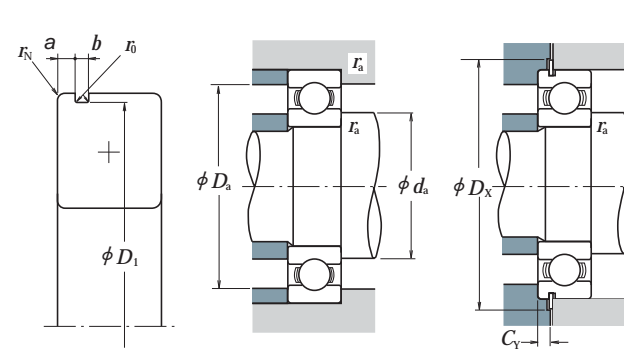
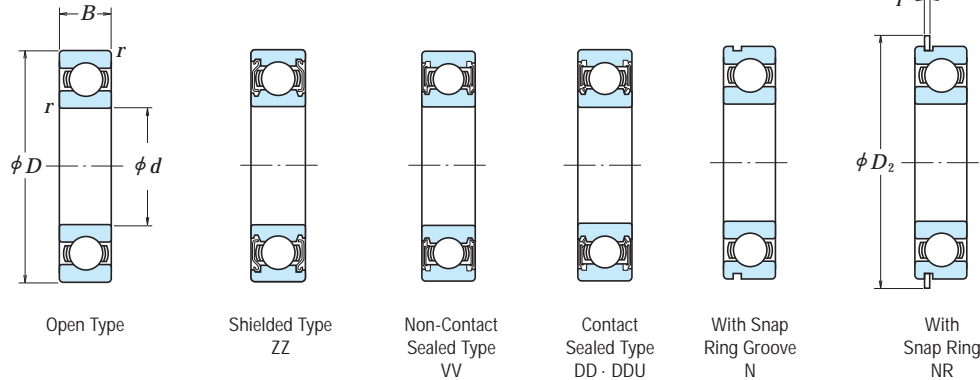

Dynamic Equivalent Load

$$P = XF_r + YF_a$$

$\frac{f_0 F_a}{C_{0r}}$	e	$\frac{F_a}{F_r} \leq e$		$\frac{F_a}{F_r} > e$	
		X	Y	X	Y
0.172	0.19	1	0	0.56	2.30
0.345	0.22	1	0	0.56	1.99
0.689	0.26	1	0	0.56	1.71
1.03	0.28	1	0	0.56	1.55
1.38	0.30	1	0	0.56	1.45
2.07	0.34	1	0	0.56	1.31
3.45	0.38	1	0	0.56	1.15
5.17	0.42	1	0	0.56	1.04
6.89	0.44	1	0	0.56	1.00

Static Equivalent Load

$$\frac{F_a}{F_r} > 0.8, P_0 = 0.6F_r + 0.5F_a$$

$$\frac{F_a}{F_r} \leq 0.8, P_0 = F_r$$

Boundary Dimensions (mm)	Basic Load Ratings (kgf)				Factor f_0	Limiting Speeds (min ⁻¹)			Bearing Numbers						
	Basic Load Ratings (N)		(kgf)			Grease		Oil	Bearing Numbers						
	C_r	C_{0r}	C_r	C_{0r}		Open Z·ZZ V·VV	DU DDU	Open Z	Open	Shielded	Sealed				
50	65	7	0.3	6 400	6 200	655	635	17.2	9 500	5 300	11 000	6810	ZZ	VV	DDU
	72	12	0.6	14 500	11 700	1 480	1 200	16.1	9 000	5 300	11 000	6910	ZZ	VV	DDU
	80	10	0.6	15 400	12 400	1 570	1 260	16.1	8 500	—	10 000	16010	—	—	—
	80	16	1	21 800	16 600	2 220	1 700	15.6	8 500	4 800	10 000	6010	ZZ	VV	DDU
	90	20	1.1	35 000	23 200	3 600	2 370	14.4	7 100	4 800	8 500	6210	ZZ	VV	DDU
	110	27	2	62 000	38 500	6 300	3 900	13.2	6 000	4 300	7 500	6310	ZZ	VV	DDU
55	72	9	0.3	8 800	8 500	900	865	17.0	8 500	4 800	10 000	6811	ZZ	VV	DDU
	80	13	1	16 000	13 300	1 630	1 350	16.2	8 000	4 500	9 500	6911	ZZ	VV	DDU
	90	11	0.6	19 400	16 300	1 980	1 660	16.2	7 500	—	9 000	16011	—	—	—
	90	18	1.1	28 300	21 200	2 880	2 170	15.3	7 500	4 500	9 000	6011	ZZ	VV	DDU
	100	21	1.5	43 500	29 300	4 450	2 980	14.3	6 300	4 300	7 500	6211	ZZ	VV	DDU
	120	29	2	71 500	44 500	7 300	4 550	13.1	5 600	4 000	6 700	6311	ZZ	VV	DDU
60	78	10	0.3	11 500	10 900	1 170	1 120	16.9	8 000	4 500	9 500	6812	ZZ	VV	DD
	85	13	1	19 400	16 300	1 980	1 660	16.2	7 500	4 300	9 000	6912	ZZ	VV	DDU
	95	11	0.6	20 000	17 500	2 040	1 780	16.3	7 100	—	8 500	16012	—	—	—
	95	18	1.1	29 500	23 200	3 000	2 370	15.6	7 100	4 000	8 500	6012	ZZ	VV	DDU
	110	22	1.5	52 500	36 000	5 350	3 700	14.3	5 600	3 800	7 100	6212	ZZ	VV	DDU
	130	31	2.1	82 000	52 000	8 350	5 300	13.1	5 300	3 600	6 300	6312	ZZ	VV	DDU
65	85	10	0.6	11 900	12 100	1 220	1 230	17.0	7 500	4 000	8 500	6813	ZZ	VV	DD
	90	13	1	17 400	16 100	1 770	1 640	16.6	7 100	4 000	8 500	6913	ZZ	VV	DDU
	100	11	0.6	20 500	18 700	2 090	1 910	16.5	6 700	—	8 000	16013	—	—	—
	100	18	1.1	30 500	25 200	3 100	2 570	15.8	6 700	4 000	8 000	6013	ZZ	VV	DDU
	120	23	1.5	57 500	40 000	5 850	4 100	14.4	5 300	3 600	6 300	6213	ZZ	VV	DDU
	140	33	2.1	92 500	60 000	9 450	6 100	13.2	4 800	3 400	6 000	6313	ZZ	VV	DDU
70	90	10	0.6	12 100	12 700	1 230	1 300	17.2	6 700	3 800	8 000	6814	ZZ	VV	DD
	100	16	1	23 700	21 200	2 420	2 160	16.3	6 300	3 600	7 500	6914	ZZ	VV	DDU
	110	13	0.6	26 800	23 600	2 730	2 410	16.3	6 000	—	7 100	16014	—	—	—
	110	20	1.1	38 000	31 000	3 900	3 150	15.6	6 000	3 600	7 100	6014	ZZ	VV	DDU
	125	24	1.5	62 000	44 000	6 350	4 500	14.5	5 000	3 400	6 300	6214	ZZ	VV	DDU
	150	35	2.1	104 000	68 000	10 600	6 950	13.2	4 500	3 200	5 300	6314	ZZ	VV	DDU
75	95	10	0.6	12 500	13 900	1 280	1 410	17.3	6 300	3 600	7 500	6815	ZZ	VV	DDU
	105	16	1	24 400	22 600	2 480	2 300	16.5	6 000	3 400	7 100	6915	ZZ	VV	DDU
	115	13	0.6	27 600	25 300	2 820	2 580	16.4	5 600	—	6 700	16015	—	—	—
	115	20	1.1	39 500	33 500	4 050	3 400	15.8	5 600	3 400	6 700	6015	ZZ	VV	DDU
	130	25	1.5	66 000	49 500	6 750	5 050	14.7	4 800	3 200	5 600	6215	ZZ	VV	DDU
	160	37	2.1	113 000	77 000	11 600	7 850	13.2	4 300	2 800	5 000	6315	ZZ	VV	DDU

With Snap Ring Groove	With Snap Ring	Snap Ring Groove Dimensions (1)					Snap Ring (1) Dimensions (mm)		Abutment and Fillet Dimensions (mm)					Mass (kg) approx.	
		a max.	b min.	D ₁ max.	r ₀ max.	r _N min.	D ₂ max.	f max.	d _a (2) min.	d _a (2) max.	D _a (2) max.	r _a max.	D _x min.		C _y max.
N	NR	1.3	0.95	63.7	0.25	0.3	67.8	0.85	52	52.5	63	0.3	68.5	1.8	0.050
N	NR	1.7	0.95	70.7	0.25	0.5	74.8	0.85	54	55	68	0.6	76	2.3	0.135
N	NR	—	—	—	—	—	—	—	54	—	76	0.6	—	—	0.175
N	NR	2.49	1.9	76.81	0.6	0.5	86.6	1.7	55	58.5	75	1	88	3.8	0.261
N	NR	3.28	2.7	86.79	0.6	0.5	96.5	2.46	56.5	60	83.5	1	98	5.4	0.459
N	NR	3.28	2.7	106.81	0.6	0.5	116.6	2.46	59	68	101	2	118	5.4	1.06
N	NR	1.7	0.95	70.7	0.25	0.3	74.8	0.85	57	59	70	0.3	76	2.3	0.081
N	NR	2.1	1.3	77.9	0.4	0.5	84.4	1.12	60	61.5	75	1	86	2.9	0.189
N	NR	—	—	—	—	—	—	—	59	—	86	0.6	—	—	0.257
N	NR	2.87	2.7	86.79	0.6	0.5	96.5	2.46	61.5	64	83.5	1	98	5	0.381
N	NR	3.28	2.7	96.8	0.6	0.5	106.5	2.46	63	66.5	92	1.5	108	5.4	0.619
N	NR	4.06	3.1	115.21	0.6	0.5	129.7	2.82	64	72.5	111	2	131.5	6.5	1.37
N	NR	1.7	1.3	76.2	0.4	0.3	82.7	1.12	62	64	76	0.3	84	2.5	0.103
N	NR	2.1	1.3	82.9	0.4	0.5	89.4	1.12	65	66	80	1	91	2.9	0.192
N	NR	—	—	—	—	—	—	—	64	—	91	0.6	—	—	0.281
N	NR	2.87	2.7	91.82	0.6	0.5	101.6	2.46	66.5	69	88.5	1	103	5	0.412
N	NR	3.28	2.7	106.81	0.6	0.5	116.6	2.46	68	74.5	102	1.5	118	5.4	0.783
N	NR	4.06	3.1	125.22	0.6	0.5	139.7	2.82	71	79	119	2	141.5	6.5	1.72
N	NR	1.7	1.3	82.9	0.4	0.5	89.4	1.12	69	69	81	0.6	91	2.5	0.128
N	NR	2.1	1.3	87.9	0.4	0.5	94.4	1.12	70	71.5	85	1	96	2.9	0.218
N	NR	—	—	—	—	—	—	—	69	—	96	0.6	—	—	0.30
N	NR	2.87	2.7	96.8	0.6	0.5	106.5	2.46	71.5	73	93.5	1	108	5	0.439
N	NR	4.06	3.1	115.21	0.6	0.5	129.7	2.82	73	80	112	1.5	131.5	6.5	1.0
N	NR	4.9	3.1	135.23	0.6	0.5	149.7	2.82	76	85.5	129	2	152	7.3	2.11
N	NR	1.7	1.3	87.9	0.4	0.5	94.4	1.12	74	74.5	86	0.6	96	2.5	0.134
N	NR	2.5	1.3	97.9	0.4	0.5	104.4	1.12	75	77.5	95	1	106	3.3	0.349
N	NR	—	—	—	—	—	—	—	74	—	106	0.6	—	—	0.441
N	NR	2.87	2.7	106.81	0.6	0.5	116.6	2.46	76.5	80.5	103.5	1	118	5	0.608
N	NR	4.06	3.1	120.22	0.6	0.5	134.7	2.82	78	84	117	1.5	136.5	6.5	1.09
N	NR	4.9	3.1	145.24	0.6	0.5	159.7	2.82	81	92	139	2	162	7.3	2.57
N	NR	1.7	1.3	92.9	0.4	0.5	99.4	1.12	79	79.5	91	0.6	101	2.5	0.149
N	NR	2.5	1.3	102.6	0.4	0.5	110.7	1.12	80	82	100	1	112	3.3	0.364
N	NR	—	—	—	—	—	—	—	79	—	111	0.6	—	—	0.463
N	NR	2.87	2.7	111.81	0.6	0.5	121.6	2.46	81.5	85.5	108.5	1	123	5	0.649
N	NR	4.06	3.1	125.22	0.6	0.5	139.7	2.82	83	90	122	1.5	141.5	6.5	1.19
N	NR	4.9	3.1	155.22	0.6	0.5	169.7	2.82	86	98.5	149	2	172	7.3	3.08

Notes (1) For tolerances for the snap ring grooves and snap ring dimensions, refer to Pages A50 to A53.

(2) When heavy axial loads are applied, increase d_a and decrease D_a from the above values.

Remarks 1. Diameter Series 7 (extra thin section bearings) are also available, please contact NSK.

2. When using bearings with rotating outer rings, contact NSK if they are sealed, shielded, or have snap rings.

3. Please consult NSK about the snap ring groove dimensions of sealed and shielded bearings when the diameter of dimension series 18 and 19 is 50 mm or more.

Bore Diameter 80 – 105 mm

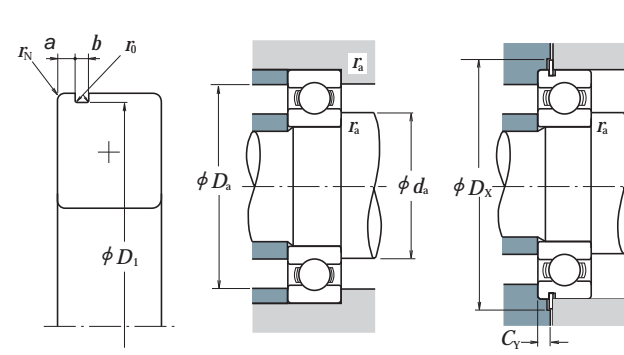
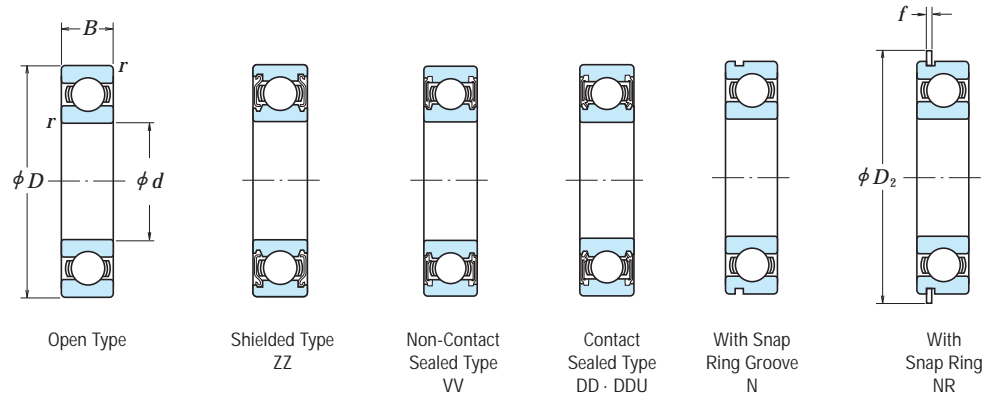

Dynamic Equivalent Load

$$P = XF_r + YF_a$$

$\frac{f_0 F_a}{C_{0r}}$	e	$\frac{F_a}{F_r} \leq e$		$\frac{F_a}{F_r} > e$	
		X	Y	X	Y
0.172	0.19	1	0	0.56	2.30
0.345	0.22	1	0	0.56	1.99
0.689	0.26	1	0	0.56	1.71
1.03	0.28	1	0	0.56	1.55
1.38	0.30	1	0	0.56	1.45
2.07	0.34	1	0	0.56	1.31
3.45	0.38	1	0	0.56	1.15
5.17	0.42	1	0	0.56	1.04
6.89	0.44	1	0	0.56	1.00

Static Equivalent Load

$$\frac{F_a}{F_r} > 0.8, P_0 = 0.6F_r + 0.5F_a$$

$$\frac{F_a}{F_r} \leq 0.8, P_0 = F_r$$

Boundary Dimensions (mm)	Basic Load Ratings (kgf)				Factor f_0	Limiting Speeds (min ⁻¹)			Bearing Numbers						
	Basic Load Ratings (N)		(kgf)			Grease		Oil	Bearing Numbers						
	C_r	C_{0r}	C_r	C_{0r}		Open Z	ZZ V·VV	DU DDU	Open Z	Open	Shielded	Sealed			
80	100	10	0.6	12 700	14 500	1 290	1 470	17.4	6 000	3 400	7 100	6816	ZZ	VV	DDU
	110	16	1	25 000	24 000	2 540	2 450	16.6	5 600	3 200	6 700	6916	ZZ	VV	DDU
	125	14	0.6	32 000	29 600	3 250	3 000	16.4	5 300	—	6 300	16016	—	—	—
	125	22	1.1	47 500	40 000	4 850	4 050	15.6	5 300	3 200	6 300	6016	ZZ	VV	DDU
85	140	26	2	72 500	53 000	7 400	5 400	14.6	4 500	3 000	5 300	6216	ZZ	VV	DDU
	170	39	2.1	123 000	86 500	12 500	8 850	13.3	4 000	2 800	4 800	6316	ZZ	VV	DDU
	110	13	1	18 700	20 000	1 910	2 040	17.1	5 600	3 200	6 700	6817	ZZ	VV	DDU
	120	18	1.1	32 000	29 600	3 250	3 000	16.4	5 300	3 000	6 300	6917	ZZ	VV	DDU
	130	14	0.6	33 000	31 500	3 350	3 200	16.5	5 000	—	6 000	16017	—	—	—
	130	22	1.1	49 500	43 000	5 050	4 400	15.8	5 000	3 000	6 000	6017	ZZ	VV	DDU
	150	28	2	84 000	62 000	8 550	6 300	14.5	4 300	2 800	5 000	6217	ZZ	VV	DDU
	180	41	3	133 000	97 000	13 500	9 850	13.3	3 800	2 600	4 500	6317	ZZ	VV	DDU
	115	13	1	19 000	21 000	1 940	2 140	17.2	5 300	3 000	6 300	6818	ZZ	VV	DDU
	125	18	1.1	33 000	31 500	3 350	3 200	16.5	5 000	2 800	6 000	6918	ZZ	VV	DDU
	140	16	1	41 500	39 500	4 250	4 000	16.3	4 800	—	5 600	16018	—	—	—
	90	140	24	1.5	58 000	50 000	5 950	5 050	15.6	4 800	2 800	5 600	6018	ZZ	VV
160		30	2	96 000	71 500	9 800	7 300	14.5	4 000	2 600	4 800	6218	ZZ	VV	DDU
190		43	3	143 000	107 000	14 500	11 000	13.3	3 600	2 400	4 300	6318	ZZ	VV	DDU
120		13	1	19 300	22 000	1 970	2 240	17.2	5 000	2 800	6 000	6819	ZZ	VV	DD
130		18	1.1	33 500	33 500	3 450	3 400	16.6	4 800	2 800	5 600	6919	ZZ	VV	DDU
145		16	1	43 000	42 000	4 350	4 250	16.4	4 500	—	5 300	16019	—	—	—
95	145	24	1.5	60 500	54 000	6 150	5 500	15.8	4 500	2 600	5 300	6019	ZZ	VV	DDU
	170	32	2.1	109 000	82 000	11 100	8 350	14.4	3 800	2 600	4 500	6219	ZZ	VV	DDU
	200	45	3	153 000	119 000	15 600	12 100	13.3	3 000	2 400	3 600	6319	ZZ	VV	DDU
	125	13	1	19 600	23 000	2 000	2 340	17.3	4 800	2 800	5 600	6820	ZZ	VV	DD
	140	20	1.1	43 000	42 000	4 350	4 250	16.4	4 500	2 600	5 300	6920	ZZ	VV	DDU
	150	16	1	42 500	42 000	4 300	4 300	16.5	4 300	—	5 300	16020	—	—	—
100	150	24	1.5	60 000	54 000	6 150	5 550	15.9	4 300	2 600	5 300	6020	ZZ	VV	DDU
	180	34	2.1	122 000	93 000	12 500	9 500	14.4	3 600	2 400	4 300	6220	ZZ	VV	DDU
	215	47	3	173 000	141 000	17 700	14 400	13.2	2 800	2 200	3 400	6320	ZZ	VV	DDU
	130	13	1	19 800	23 900	2 020	2 440	17.4	4 800	2 600	5 600	6821	ZZ	VV	DDU
	145	20	1.1	42 500	42 000	4 300	4 300	16.5	4 300	—	5 300	6921	ZZ	VV	—
	160	18	1	52 000	50 500	5 300	5 150	16.3	4 000	—	4 800	16021	—	—	—
105	160	26	2	72 500	66 000	7 400	6 700	15.8	4 000	2 400	4 800	6021	ZZ	VV	DDU
	190	36	2.1	133 000	105 000	13 600	10 700	14.4	3 400	2 200	4 000	6221	ZZ	VV	DDU
	225	49	3	184 000	154 000	18 700	15 700	13.2	2 600	2 000	3 200	6321	ZZ	—	DDU

With Snap Ring Groove	With Snap Ring	Snap Ring Groove Dimensions (1)					Snap Ring (1) Dimensions (mm)		Abutment and Fillet Dimensions (mm)					Mass (kg) approx.
		a max.	b min.	D1 max.	r0 max.	rN min.	D2 max.	f max.	da(2) min.	da(2) max.	ra max.	Dx min.	Cy max.	
N	NR	1.7	1.3	97.9	0.4	0.5	104.4	1.12	84	84.5	96	0.6	106	2.5
N	NR	2.5	1.3	107.6	0.4	0.5	115.7	1.12	85	87.5	105	1	117	3.3
—	—	—	—	—	—	—	—	—	84	—	121	0.6	—	0.621
N	NR	2.87	3.1	120.22	0.6	0.5	134.7	2.82	86.5	91	118.5	1	136.5	5.3
N	NR	4.9	3.1	135.23	0.6	0.5	149.7	2.82	89	95.5	131	2	152	7.3
N	NR	5.69	3.5	163.65	0.6	0.5	182.9	3.1	91	104.5	159	2	185	8.4
N	NR	2.1	1.3	107.6	0.4	0.5	115.7	1.12	90	90.5	105	1	117	2.9
N	NR	3.3	1.3	117.6	0.4	0.5	125.7	1.12	91.5	94.5	113.5	1	127	4.1
—	—	—	—	—	—	—	—	—	89	—	126	0.6	—	0.652
N	NR	2.87	3.1	125.22	0.6	0.5	139.7	2.82	91.5	96	123.5	1	141.5	5.3
N	NR	4.9	3.1	145.24	0.6	0.5	159.7	2.82	94	102	141	2	162	7.3
N	NR	5.69	3.5	173.66	0.6	0.5	192.9	3.1	98	110.5	167	2.5	195	8.4
N	NR	2.1	1.3	112.6	0.4	0.5	120.7	1.12	95	95.5	110	1	122	2.9
N	NR	3.3	1.3	122.6	0.4	0.5	130.7	1.12	96.5	98.5	118.5	1	132	4.1
—	—	—	—	—	—	—	—	—	95	—	135	1	—	0.873
N	NR	3.71	3.1	135.23	0.6	0.5	149.7	2.82	98	103	132	1.5	152	6.1
N	NR	4.9	3.1	155.22	0.6	0.5	169.7	2.82	99	107.5	151	2	172	7.3
N	NR	5.69	3.5	183.64	0.6	0.5	202.9	3.1	103	117	177	2.5	205	8.4
N	NR	2.1	1.3	117.6	0.4	0.5	125.7	1.12	100	101.5	115	1	127	2.9
N	NR	3.3	1.3	127.6	0.4	0.5	135.7	1.12	101.5	103.5	123.5	1	137	4.1
—	—	—	—	—	—	—	—	—	100	—	140	1	—	0.904
N	NR	3.71	3.1	140.23	0.6	0.5	154.7	2.82	103	108.5	137	1.5	157	6.1
N	NR	5.69	3.5	163.65	0.6	0.5	182.9	3.1	106	114	159	2	185	8.4
N	NR	5.69	3.5	193.65	0.6	0.5	212.9	3.1	108	123.5	187	2.5	215	8.4
N	NR	2.1	1.3	122.6	0.4	0.5	130.7	1.12	105	105.5	120	1	132	2.9
N	NR	3.3	1.9	137.6	0.6	0.5	145.7	1.7	106.5	111	133.5	1	147	4.7
—	—	—	—	—	—	—	—	—	105	—	145	1	—	0.945
N	NR	3.71	3.1	145.24	0.6	0.5	159.7	2.82	108	112.5	142	1.5	162	6.1
N	NR	5.69	3.5	173.66	0.6	0.5	192.9	3.1	111	121.5	169	2	195	8.4
—	—	—	—	—	—	—	—	—	113	133	202	2.5	—	7.04
N	NR	2.1	1.3	127.6	0.4	0.5	135.7	1.12	110	110.5	125	1	137	2.9
N	NR	3.3	1.9	142.6	0.6	0.5	150.7	1.7	111.5	116	138.5	1	152	4.7
—	—	—	—	—	—	—	—	—	110	—	155	1	—	1.24
N	NR	3.71	3.1	155.22	0.6	0.5	169.7	2.82	114	120	151	2	172	6.1
N	NR	5.69	3.5	183.64	0.6	0.5	202.9	3.1	116	127.5	179	2	205	8.4
—	—	—	—	—	—	—	—	—	118	138	212	2.5	—	8.09

Notes (1) For tolerances for the snap ring grooves and snap ring dimensions, refer to Pages A50 to A53.

(2) When heavy axial loads are applied, increase d_a and decrease D_a from the above values.

- Remarks
1. Diameter Series 7 (extra thin section bearings) are also available, please contact NSK.
 2. When using bearings with rotating outer rings, contact NSK if they are sealed, shielded, or have snap rings.
 3. Please consult NSK about the snap ring groove dimensions of sealed and shielded bearings when the diameter of dimension series 18 and 19 is 50 mm or more.

SINGLE-ROW DEEP GROOVE BALL BEARINGS

Bore Diameter 110 – 160 mm

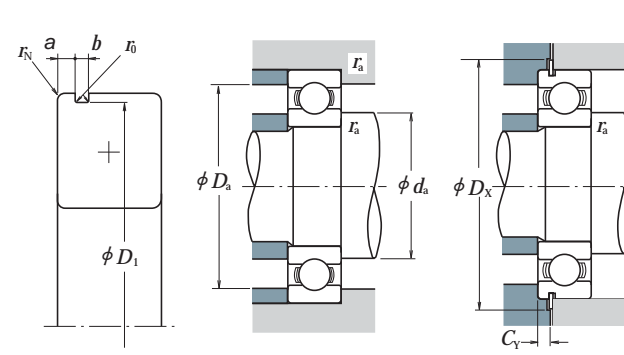
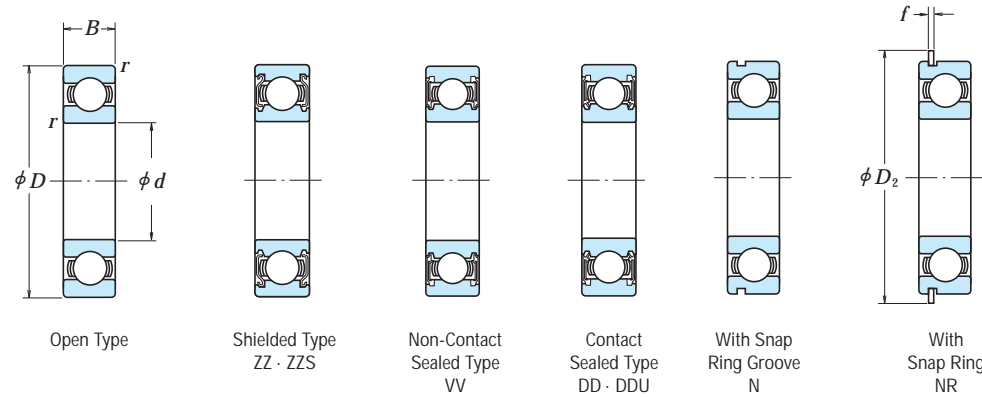

Dynamic Equivalent Load

$$P = XF_r + YF_a$$

$\frac{f_0 F_a}{C_{0r}}$	e	$\frac{F_a}{F_r} \leq e$		$\frac{F_a}{F_r} > e$	
		X	Y	X	Y
0.172	0.19	1	0	0.56	2.30
0.345	0.22	1	0	0.56	1.99
0.689	0.26	1	0	0.56	1.71
1.03	0.28	1	0	0.56	1.55
1.38	0.30	1	0	0.56	1.45
2.07	0.34	1	0	0.56	1.31
3.45	0.38	1	0	0.56	1.15
5.17	0.42	1	0	0.56	1.04
6.89	0.44	1	0	0.56	1.00

Static Equivalent Load

$$\frac{F_a}{F_r} > 0.8, P_0 = 0.6F_r + 0.5F_a$$

$$\frac{F_a}{F_r} \leq 0.8, P_0 = F_r$$

Boundary Dimensions (mm)	Basic Load Ratings (kgf)				Factor f_0	Limiting Speeds (min ⁻¹)			Bearing Numbers						
	Basic Load Ratings (N)		(kgf)			Grease		Oil	Bearing Numbers						
	C_r	C_{0r}	C_r	C_{0r}		Open Z · ZZ V · VV	DU DDU	Open Z	Open	Shielded	Sealed				
110	140	16	1	28 100	32 500	2 860	3 350	17.1	4 300	2 400	5 300	6822	ZZ	VV	DDU
	150	20	1.1	43 500	44 500	4 450	4 550	16.6	4 300	2 400	5 000	6922	ZZ	VV	DDU
	170	19	1	57 500	56 500	5 850	5 800	16.3	3 800	—	4 500	16022	—	—	—
120	170	28	2	85 000	73 000	8 650	7 450	15.5	3 800	2 200	4 500	6022	ZZ	VV	DDU
	200	38	2.1	144 000	117 000	14 700	11 900	14.3	2 800	2 200	3 400	6222	ZZ	VV	DDU
	240	50	3	205 000	179 000	20 900	18 300	13.2	2 400	—	3 000	6322	ZZ	—	—
130	150	16	1	28 900	35 500	2 950	3 650	17.3	4 000	2 200	4 800	6824	ZZ	VV	DD
	165	22	1.1	53 000	54 000	5 400	5 500	16.5	3 800	—	4 500	6924	ZZ	—	—
	180	19	1	56 500	57 500	5 800	5 850	16.5	3 600	—	4 300	16024	—	—	—
140	180	28	2	88 000	80 000	9 000	8 150	15.7	3 600	2 200	4 300	6024	ZZ	VV	DDU
	215	40	2.1	155 000	131 000	15 800	13 400	14.4	2 600	2 000	3 200	6224	ZZ	VV	DDU
	260	55	3	207 000	185 000	21 100	18 800	13.5	2 200	1 800	2 800	6324	ZZS	—	DDU
150	165	18	1.1	37 000	44 000	3 750	4 450	17.1	3 600	2 000	4 300	6826	ZZS	VV	DD
	180	24	1.5	65 000	67 500	6 650	6 850	16.5	3 400	—	4 000	6926	ZZ	—	—
	200	22	1.1	75 500	77 500	7 700	7 900	16.4	3 000	—	3 600	16026	—	—	—
160	200	33	2	106 000	101 000	10 800	10 300	15.8	3 000	1 900	3 600	6026	ZZ	—	DDU
	230	40	3	167 000	146 000	17 000	14 900	14.5	2 400	—	3 000	6226	ZZ	—	—
	280	58	4	229 000	214 000	23 400	21 800	13.6	2 200	—	2 600	6326	ZZS	—	—
170	175	18	1.1	38 500	48 000	3 900	4 850	17.3	3 400	1 900	4 000	6828	ZZ	VV	DDU
	190	24	1.5	66 500	72 000	6 800	7 300	16.6	3 200	—	3 800	6928	ZZS	VV	—
	210	22	1.1	77 500	82 500	7 900	8 400	16.5	2 800	—	3 400	16028	—	—	—
180	210	33	2	110 000	109 000	11 200	11 100	16.0	2 800	1 800	3 400	6028	ZZ	—	DDU
	250	42	3	166 000	150 000	17 000	15 300	14.9	2 200	1 700	2 800	6228	ZZS	—	DDU
	300	62	4	253 000	246 000	25 800	25 100	13.6	2 000	—	2 400	6328	ZZS	—	—
190	190	20	1.1	47 500	58 500	4 850	5 950	17.1	3 200	1 800	3 800	6830	ZZ	VV	DDU
	210	28	2	85 000	90 500	8 650	9 200	16.5	2 600	1 700	3 200	6930	ZZS	—	DDU
	225	24	1.1	84 000	91 000	8 550	9 250	16.6	2 600	—	3 000	16030	—	—	—
200	225	35	2.1	126 000	126 000	12 800	12 800	15.9	2 600	1 700	3 000	6030	ZZ	VV	DDU
	270	45	3	176 000	168 000	18 000	17 100	15.1	2 000	—	2 600	6230	ZZS	—	—
	320	65	4	274 000	284 000	28 000	28 900	13.9	1 800	—	2 200	6330	ZZS	—	—
210	200	20	1.1	48 500	61 000	4 950	6 250	17.2	2 600	1 700	3 200	6832	ZZS	VV	DDU
	220	28	2	87 000	96 000	8 850	9 800	16.6	2 600	1 600	3 000	6932	ZZS	—	DDU
	240	25	1.5	99 000	108 000	10 100	11 000	16.5	2 400	—	2 800	16032	—	—	—
220	240	38	2.1	137 000	135 000	13 900	13 800	15.9	2 400	1 600	2 800	6032	ZZ	—	DDU
	290	48	3	185 000	186 000	18 900	19 000	15.4	1 900	—	2 400	6232	ZZS	—	—
	340	68	4	278 000	287 000	28 300	29 200	13.9	1 700	—	2 000	6332	ZZS	—	—

With Snap Ring Groove	With Snap Ring	Snap Ring Groove Dimensions (1) (mm)					Snap Ring (1) Dimensions (mm)		Abutment and Fillet Dimensions (mm)					Mass (kg) approx.	
		a max.	b min.	D1 max.	r0 max.	rN min.	D2 max.	f max.	da(2) min.	da(2) max.	ra max.	Dx min.	Cy max.		
N	NR	2.5	1.9	137.6	0.6	0.5	145.7	1.7	115	117	135	1	147	3.9	0.497
N	NR	3.3	1.9	147.6	0.6	0.5	155.7	1.7	116.5	121	143.5	1	157	4.7	0.893
—	—	—	—	—	—	—	—	—	115	—	165	1	—	—	1.51
N	NR	3.71	3.5	163.65	0.6	0.5	182.9	3.1	119	124.5	161	2	185	6.4	1.94
N	NR	5.69	3.5	193.65	0.6	0.5	212.9	3.1	121	134	189	2	215	8.4	4.45
—	—	—	—	—	—	—	—	—	123	147	227	2.5	—	—	9.51
N	NR	2.5	1.9	147.6	0.6	0.5	155.7	1.7	125	127	145	1	157	3.9	0.537
N	NR	3.7	1.9	161.8	0.6	0.5	171.5	1.7	126.5	132	158.5	1	173	5.1	1.21
—	—	—	—	—	—	—	—	—	125	—	175	1	—	—	1.6
N	NR	3.71	3.5	173.66	0.6	0.5	192.9	3.1	129	134.5	171	2	195	6.4	2.08
—	—	—	—	—	—	—	—	—	131	146	204	2	—	—	5.29
—	—	—	—	—	—	—	—	—	133	161	247	2.5	—	—	12.5
N	NR	3.3	1.9	161.8	0.6	0.5	171.5	1.7	136.5	138	158.5	1	173	4.7	0.758
N	NR	3.7	1.9	176.8	0.6	0.5	186.5	1.7	138	144	172	1.5	188	5.1	1.57
—	—	—	—	—	—	—	—	—	136.5	—	193.5	1	—	—	2.4
N	NR	5.69	3.5	193.65	0.6	0.5	212.9	3.1	139	148.5	191	2	215	8.4	3.26
—	—	—	—	—	—	—	—	—	143	157	217	2.5	—	—	5.96
—	—	—	—	—	—	—	—	—	146	175	264	3	—	—	15.2
N	NR	3.3	1.9	171.8	0.6	0.5	181.5	1.7	146.5	148.5	168.5	1	183	4.7	0.832
N	NR	3.7	1.9	186.8	0.6	0.5	196.5	1.7	148	153.5	182	1.5	198	5.1	1.67
—	—	—	—	—	—	—	—	—	146.5	—	203.5	1	—	—	2.84
—	—	—	—	—	—	—	—	—	149	158.5	201	2	—	—	3.48
—	—	—	—	—	—	—	—	—	153	171.5	237	2.5	—	—	7.68
—	—	—	—	—	—	—	—	—	156	187	284	3	—	—	18.5
N	NR	3.3	1.9	186.8	0.6	0.5	196.5	1.7	156.5	160	183.5	1	198	4.7	1.15
—	—	—	—	—	—	—	—	—	159	166	201	2	—	—	3.01
—	—	—	—	—	—	—	—	—	156.5	—	218.5	1	—	—	3.62
—	—	—	—	—	—	—	—	—	161	170	214	2	—	—	4.24
—	—	—	—	—	—	—	—	—	163	186	257	2.5	—	—	10
—	—	—	—	—	—	—	—	—	166	203	304	3	—	—	22.7
N	NR	3.3	1.9	196.8	0.6	0.5	206.5	1.7	166.5	170.5	193.5	1	208	4.7	1.23
—	—	—	—	—	—	—	—	—	169	176	211	2	—	—	2.71
—	—	—	—	—	—	—	—	—	168	—	232	1.5	—	—	4.2
—	—	—	—	—	—	—	—	—	171	181.5	229	2	—	—	5.15
—	—	—	—	—	—	—	—	—	173	202	277	2.5	—	—	12.8
—	—	—	—	—	—	—	—	—	176	215.5	324	3	—	—	26.2

Notes (1) For tolerances for the snap ring grooves and snap ring dimensions, refer to Pages A50 to A53.

(2) When heavy axial loads are applied, increase d_a and decrease D_a from the above values.

Remarks 1. When using bearings with rotating outer rings, contact NSK if they are sealed, shielded, or have snap rings.
2. Please consult NSK about the snap ring groove dimensions of sealed and shielded bearings when the diameter of dimension series 18 and 19 is 50 mm or more.

Bore Diameter 170 – 240 mm

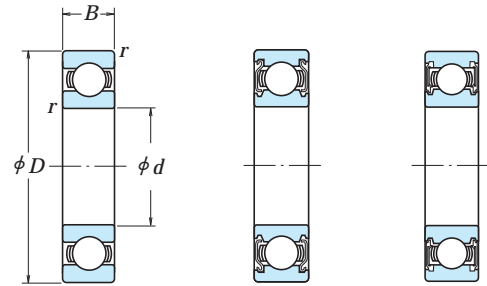

Open Type

Shielded Type
ZZS

Non-Contact
Sealed Type
VV

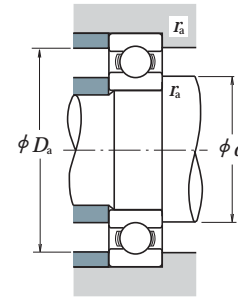

Dynamic Equivalent Load

$$P = XF_r + YF_a$$

$\frac{f_0 F_a}{C_{0r}}$	e	$\frac{F_a}{F_r} \leq e$		$\frac{F_a}{F_r} > e$	
		X	Y	X	Y
0.172	0.19	1	0	0.56	2.30
0.345	0.22	1	0	0.56	1.99
0.689	0.26	1	0	0.56	1.71
1.03	0.28	1	0	0.56	1.55
1.38	0.30	1	0	0.56	1.45
2.07	0.34	1	0	0.56	1.31
3.45	0.38	1	0	0.56	1.15
5.17	0.42	1	0	0.56	1.04
6.89	0.44	1	0	0.56	1.00

Static Equivalent Load

$$\frac{F_a}{F_r} > 0.8, P_0 = 0.6F_r + 0.5F_a$$

$$\frac{F_a}{F_r} \leq 0.8, P_0 = F_r$$

Boundary Dimensions (mm)	Basic Load Ratings (kgf)				Factor f_0	Limiting Speeds (min ⁻¹)			Bearing Numbers						
	d	D	B	r min.		Grease		Oil	Open	Shielded	Sealed				
						Open Z · ZZ V · VV	DU DDU	Open Z							
170	215	22	1.1	60 000	75 000	6 100	7 650	17.1	2 600	1 600	3 000	6834	ZZS	VV	DDU
	230	28	2	86 000	97 000	8 750	9 850	16.7	2 400	—	2 800	6934	ZZS	—	—
	260	28	1.5	114 000	126 000	11 700	12 900	16.5	2 200	—	2 600	16034	—	—	—
260	260	42	2.1	161 000	161 000	16 400	16 400	15.8	2 200	—	2 600	6034	ZZS	VV	—
	310	52	4	212 000	224 000	21 700	22 800	15.3	1 800	—	2 200	6234	ZZS	—	—
	360	72	4	325 000	355 000	33 500	36 000	13.6	1 600	—	2 000	6334	—	—	—
180	225	22	1.1	60 500	78 500	6 200	8 000	17.2	2 400	—	2 800	6836	—	VV	—
	250	33	2	119 000	128 000	12 100	13 100	16.4	2 200	—	2 600	6936	ZZS	—	—
	280	31	2	145 000	157 000	14 700	16 000	16.3	2 000	—	2 400	16036	—	—	—
280	280	46	2.1	180 000	185 000	18 400	18 800	15.6	2 000	—	2 400	6036	ZZS	VV	—
	320	52	4	227 000	241 000	23 200	24 600	15.1	1 700	—	2 000	6236	ZZS	—	—
	380	75	4	355 000	405 000	36 000	41 500	13.9	1 500	—	1 800	6336	—	—	—
190	240	24	1.5	73 000	93 500	7 450	9 550	17.1	2 200	—	2 600	6838	—	VV	—
	260	33	2	113 000	127 000	11 500	13 000	16.6	2 200	—	2 600	6938	—	—	—
	290	31	2	149 000	168 000	15 200	17 100	16.4	2 000	—	2 400	16038	—	—	—
290	290	46	2.1	188 000	201 000	19 200	20 500	15.8	2 000	—	2 400	6038	ZZS	—	—
	340	55	4	255 000	282 000	26 000	28 700	15.0	1 600	—	2 000	6238	ZZS	—	—
	400	78	5	355 000	415 000	36 000	42 500	14.1	1 400	—	1 700	6338	—	—	—
200	250	24	1.5	74 000	98 000	7 550	10 000	17.2	2 200	—	2 600	6840	—	—	—
	280	38	2.1	143 000	158 000	14 600	16 100	16.4	2 000	—	2 400	6940	ZZS	—	—
	310	34	2	161 000	180 000	16 400	18 300	16.4	1 900	—	2 200	16040	—	—	—
310	310	51	2.1	207 000	226 000	21 100	23 000	15.6	1 900	—	2 200	6040	ZZS	—	—
	360	58	4	269 000	310 000	27 400	31 500	15.2	1 500	—	1 800	6240	ZZS	—	—
	420	80	5	380 000	445 000	38 500	45 500	13.8	1 300	—	1 600	6340	—	—	—
220	270	24	1.5	76 500	107 000	7 800	10 900	17.4	1 900	—	2 400	6844	ZZS	—	—
	300	38	2.1	146 000	169 000	14 900	17 300	16.6	1 800	—	2 200	6944	ZZS	—	—
	340	37	2.1	180 000	217 000	18 400	22 100	16.5	1 600	—	2 000	16044	—	—	—
340	340	56	3	235 000	271 000	24 000	27 600	15.6	1 700	—	2 000	6044	ZZS	—	—
	400	65	4	310 000	375 000	31 500	38 500	15.1	1 300	—	1 600	6244	—	—	—
	460	88	5	410 000	520 000	42 000	53 000	14.3	1 200	—	1 500	6344	—	—	—
240	300	28	2	98 500	137 000	10 000	14 000	17.3	1 700	—	2 000	6848	—	—	—
	320	38	2.1	154 000	190 000	15 700	19 400	16.8	1 700	—	2 000	6948	ZZS	—	—
	360	37	2.1	196 000	243 000	19 900	24 700	16.5	1 500	—	1 900	16048	—	—	—
360	360	56	3	244 000	296 000	24 900	30 000	15.9	1 500	—	1 900	6048	—	—	—
	440	72	4	340 000	430 000	34 500	44 000	15.2	1 200	—	1 500	6248	—	—	—
	500	95	5	470 000	625 000	48 000	63 500	14.2	1 100	—	1 300	6348	—	—	—

Abutment and Fillet Dimensions (mm)				Mass (kg)
$d_a^{(1)}$		$D_a^{(1)}$	r_a	
min.	max.	max.	max.	approx.
176.5	182	208.5	1	1.86
179	186	221	2	3.34
178	—	252	1.5	5.71
181	194.5	249	2	6.89
186	215	294	3	15.8
186	—	344	3	36.6
186.5	192	218.5	1	1.98
189	198.5	241	2	4.16
189	—	271	2	7.5
191	208	269	2	8.88
196	223	304	3	15.9
196	—	364	3	43.1
198	202.5	232	1.5	2.53
199	—	251	2	5.18
199	—	281	2	7.78
201	218	279	2	9.39
206	236	324	3	22.3
210	—	380	4	49.7
208	—	242	1.5	2.67
211	222	269	2	7.28
209	—	301	2	10
211	231.5	299	2	12
216	252	344	3	26.7
220	—	400	4	55.3
228	233.5	262	1.5	2.9
231	242	289	2	7.88
231	—	329	2	13.1
233	254.5	327	2.5	18.6
236	—	384	3	37.4
240	—	440	4	73.9
249	—	291	2	4.48
251	262	309	2	8.49
251	—	349	2	13.9
253	—	347	2.5	19.9
256	—	424	3	50.5
260	—	480	4	94.4

Note (1) When heavy axial loads are applied, increase d_a and decrease D_a from the above values.

Remarks When using bearings with rotating outer rings, contact NSK if they are sealed or shielded.

Bore Diameter 260 – 360 mm

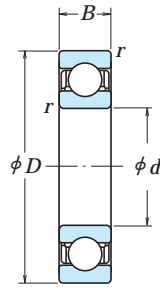

Open Type

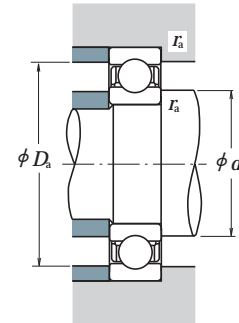

Dynamic Equivalent Load

$$P = XF_r + YF_a$$

$\frac{f_0 F_a}{C_{0r}}$	e	$\frac{F_a}{F_r} \leq e$		$\frac{F_a}{F_r} > e$	
		X	Y	X	Y
0.172	0.19	1	0	0.56	2.30
0.345	0.22	1	0	0.56	1.99
0.689	0.26	1	0	0.56	1.71
1.03	0.28	1	0	0.56	1.55
1.38	0.30	1	0	0.56	1.45
2.07	0.34	1	0	0.56	1.31
3.45	0.38	1	0	0.56	1.15
5.17	0.42	1	0	0.56	1.04
6.89	0.44	1	0	0.56	1.00

Static Equivalent Load

$$\frac{F_a}{F_r} > 0.8, P_0 = 0.6F_r + 0.5F_a$$

$$\frac{F_a}{F_r} \leq 0.8, P_0 = F_r$$

Boundary Dimensions (mm)				Basic Load Ratings (N) / (kgf)				Factor f_0	Limiting Speeds (min ⁻¹)		Bearing Numbers Open	
d	D	B	$r_{min.}$	C_r	C_{0r}	C_r	C_{0r}		Grease	Oil		
260	320	28	2	101 000	148 000	10 300	15 100	17.4	1 600	1 900	6852	
	360	46	2.1	204 000	255 000	20 800	26 000	16.5	1 500	1 800	6952	
	400	44	3	237 000	310 000	24 100	31 500	16.4	1 400	1 700	16052	
280	400	65	4	291 000	375 000	29 700	38 500	15.8	1 400	1 700	6052	
	480	80	5	400 000	540 000	41 000	55 000	15.1	1 100	1 300	6252	
	540	102	6	505 000	710 000	51 500	72 500	14.6	1 000	1 200	6352	
300	350	33	2	133 000	191 000	13 600	19 500	17.3	1 500	1 700	6856	
	380	46	2.1	209 000	272 000	21 300	27 700	16.6	1 400	1 700	6956	
	420	44	3	243 000	330 000	24 700	33 500	16.5	1 300	1 600	16056	
320	420	65	4	300 000	410 000	31 000	41 500	16.0	1 300	1 600	6056	
	500	80	5	400 000	550 000	41 000	56 000	15.2	1 000	1 300	6256	
	580	108	6	570 000	840 000	58 000	86 000	14.5	900	1 100	6356	
340	380	38	2.1	166 000	233 000	17 000	23 800	17.1	1 300	1 600	6860	
	420	56	3	269 000	370 000	27 400	38 000	16.4	1 300	1 500	6960	
	460	50	4	285 000	405 000	29 000	41 000	16.4	1 200	1 400	16060	
360	460	74	4	355 000	500 000	36 500	51 000	15.8	1 200	1 400	6060	
	540	85	5	465 000	670 000	47 500	68 500	15.1	950	1 200	6260	
	380	400	38	2.1	168 000	244 000	17 200	24 900	17.2	1 300	1 500	6864
440		56	3	266 000	375 000	27 100	38 000	16.5	1 200	1 400	6964	
480		50	4	293 000	430 000	29 800	44 000	16.5	1 100	1 300	16064	
400	480	74	4	390 000	570 000	40 000	58 000	15.7	1 100	1 300	6064	
	580	92	5	530 000	805 000	54 500	82 500	15.0	850	1 100	6264	
	420	420	38	2.1	175 000	265 000	17 800	27 100	17.3	1 200	1 400	6868
460		56	3	273 000	400 000	27 800	40 500	16.6	1 100	1 300	6968	
520		82	5	440 000	660 000	45 000	67 500	15.6	1 000	1 200	6068	
440	620	92	6	530 000	820 000	54 000	83 500	15.3	800	1 000	6268	
	460	440	38	2.1	192 000	290 000	19 600	29 600	17.3	1 100	1 300	6872
		480	56	3	280 000	425 000	28 500	43 000	16.7	1 100	1 300	6972
540		82	5	460 000	720 000	47 000	73 500	15.7	950	1 200	6072	
480	650	95	6	555 000	905 000	57 000	92 000	15.4	750	950	6272	

Abutment and Fillet Dimensions (mm)			Mass (kg) approx.
$d_a^{(1)}$ min.	$D_a^{(1)}$ max.	r_a max.	
269	311	2	4.84
271	349	2	14
273	387	2.5	21.1
276	384	3	29.4
280	460	4	67
286	514	5	118
289	341	2	7.2
291	369	2	15.1
293	407	2.5	22.7
296	404	3	31.2
300	480	4	70.4
306	554	5	144
311	369	2	10.3
313	407	2.5	23.9
316	444	3	31.5
316	444	3	44.2
320	520	4	87.8
331	389	2	10.8
333	427	2.5	25.3
336	464	3	33.2
336	464	3	46.5
340	560	4	111
351	409	2	11.5
353	447	2.5	26.6
360	500	4	62.3
366	594	5	129
371	429	2	11.8
373	467	2.5	27.9
380	520	4	65.3
386	624	5	145

Note (1) When heavy axial loads are applied, increase d_a and decrease D_a from the above values.

Bore Diameter 380 – 600 mm

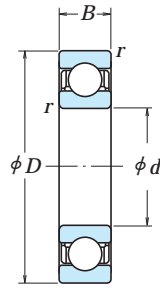

Open Type

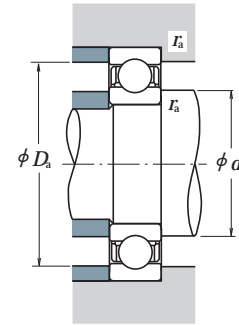

Dynamic Equivalent Load

$$P = XF_r + YF_a$$

$\frac{f_0 F_a}{C_{0r}}$	e	$\frac{F_a}{F_r} \leq e$		$\frac{F_a}{F_r} > e$	
		X	Y	X	Y
0.172	0.19	1	0	0.56	2.30
0.345	0.22	1	0	0.56	1.99
0.689	0.26	1	0	0.56	1.71
1.03	0.28	1	0	0.56	1.55
1.38	0.30	1	0	0.56	1.45
2.07	0.34	1	0	0.56	1.31
3.45	0.38	1	0	0.56	1.15
5.17	0.42	1	0	0.56	1.04
6.89	0.44	1	0	0.56	1.00

Static Equivalent Load

$$\frac{F_a}{F_r} > 0.8, P_0 = 0.6F_r + 0.5F_a$$

$$\frac{F_a}{F_r} \leq 0.8, P_0 = F_r$$

Boundary Dimensions (mm)				Basic Load Ratings (N) / (kgf)				Factor f_0	Limiting Speeds (min ⁻¹)		Bearing Numbers Open
d	D	B	$r_{min.}$	C_r	C_{0r}	C_r	C_{0r}		Grease	Oil	
380	480	46	2.1	238 000	375 000	24 200	38 000	17.1	1 000	1 200	6876
	520	65	4	325 000	510 000	33 000	52 000	16.6	950	1 200	6976
	560	82	5	455 000	725 000	46 500	74 000	15.9	900	1 100	6076
400	500	46	2.1	241 000	390 000	24 600	40 000	17.2	950	1 200	6880
	540	65	4	335 000	540 000	34 000	55 000	16.7	900	1 100	6980
	600	90	5	510 000	825 000	52 000	84 000	15.7	850	1 000	6080
420	520	46	2.1	245 000	410 000	25 000	41 500	17.3	900	1 100	6884
	560	65	4	340 000	570 000	35 000	58 500	16.8	900	1 100	6984
	620	90	5	530 000	895 000	54 000	91 000	15.8	800	1 000	6084
440	540	46	2.1	248 000	425 000	25 300	43 500	17.4	900	1 100	6888
	600	74	4	395 000	680 000	40 500	69 000	16.6	800	1 000	6988
	650	94	6	550 000	965 000	56 000	98 500	16.0	750	900	6088
460	580	56	3	310 000	550 000	31 500	56 000	17.1	800	1 000	6892
	620	74	4	405 000	720 000	41 500	73 500	16.7	800	950	6992
	680	100	6	605 000	1 080 000	62 000	110 000	15.8	710	850	6092
480	600	56	3	315 000	575 000	32 000	58 500	17.2	800	950	6896
	650	78	5	450 000	815 000	45 500	83 000	16.6	750	900	6996
	700	100	6	605 000	1 090 000	61 500	111 000	15.9	710	850	6096
500	620	56	3	320 000	600 000	33 000	61 000	17.3	750	900	68/500
	670	78	5	460 000	865 000	47 000	88 000	16.7	710	850	69/500
	720	100	6	630 000	1 170 000	64 000	120 000	16.0	670	800	60/500
530	650	56	3	325 000	625 000	33 000	63 500	17.4	710	850	68/530
	710	82	5	455 000	870 000	46 500	88 500	16.8	670	800	69/530
	780	112	6	680 000	1 300 000	69 500	133 000	16.0	600	750	60/530
560	680	56	3	330 000	650 000	33 500	66 500	17.4	670	800	68/560
	750	85	5	525 000	1 040 000	53 500	106 000	16.7	600	750	69/560
	820	115	6	735 000	1 500 000	75 000	153 000	16.2	560	670	60/560
600	730	60	3	355 000	735 000	36 000	75 000	17.5	600	710	68/600
	800	90	5	550 000	1 160 000	56 500	118 000	16.9	560	670	69/600
	870	118	6	790 000	1 640 000	80 500	168 000	16.1	530	630	60/600

Abutment and Fillet Dimensions (mm)			Mass (kg) approx.
$d_a^{(1)}$ min.	$D_a^{(1)}$ max.	r_a max.	
391	469	2	19.5
396	504	3	40
400	540	4	68
411	489	2	20.5
416	524	3	42
420	580	4	88.4
431	509	2	21.4
436	544	3	43.6
440	600	4	92.2
451	529	2	22.3
456	584	3	60.2
466	624	5	106
473	567	2.5	34.3
476	604	3	62.6
486	654	5	123
493	587	2.5	35.4
500	630	4	73.5
506	674	5	127
513	607	2.5	37.2
520	650	4	82
526	694	5	131
543	637	2.5	39.8
550	690	4	89.8
556	754	5	184
573	667	2.5	41.5
580	730	4	105
586	793.5	5	203
613	717	2.5	50.9
620	780	4	120
626	844	5	236

Note (1) When heavy axial loads are applied, increase d_a and decrease D_a from the above values.

Bore Diameter 630 – 800 mm

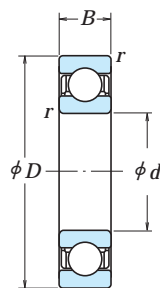

Open Type

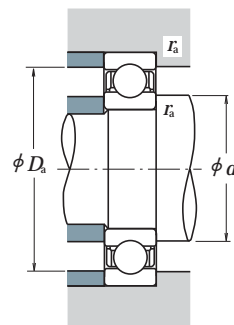

Abutment and Fillet Dimensions (mm)			Mass (kg)
$d_a^{(1)}$ min.	$D_a^{(1)}$ max.	r_a max.	
646	764	3	71.3
656	824	5	163
662	888	6	285
686	804	3	75.4
696	874	5	181
702	948	6	351
726	854	3	92.6
736	924	5	208
770	900	4	110
776	974	5	245
820	960	4	132
826	1 034	5	275

Dynamic Equivalent Load

$$P = XF_r + YF_a$$

$\frac{f_0 F_a}{C_{0r}}$	e	$\frac{F_a}{F_r} \leq e$		$\frac{F_a}{F_r} > e$	
		X	Y	X	Y
0.172	0.19	1	0	0.56	2.30
0.345	0.22	1	0	0.56	1.99
0.689	0.26	1	0	0.56	1.71
1.03	0.28	1	0	0.56	1.55
1.38	0.30	1	0	0.56	1.45
2.07	0.34	1	0	0.56	1.31
3.45	0.38	1	0	0.56	1.15
5.17	0.42	1	0	0.56	1.04
6.89	0.44	1	0	0.56	1.00

Static Equivalent Load

$$\frac{F_a}{F_r} > 0.8, P_0 = 0.6F_r + 0.5F_a$$

$$\frac{F_a}{F_r} \leq 0.8, P_0 = F_r$$

Boundary Dimensions (mm)				Basic Load Ratings				Factor	Limiting Speeds		Bearing Numbers
d	D	B	r min.	(N)		{kgf}			f_0	(min ⁻¹)	
				C_r	C_{0r}	C_r	C_{0r}			Grease	Oil
630	780	69	4	420 000	890 000	43 000	90 500	17.3	560	670	68/630
	850	100	6	625 000	1 350 000	64 000	138 000	16.7	530	630	69/630
	920	128	7.5	750 000	1 620 000	76 500	165 000	16.4	480	600	60/630
670	820	69	4	435 000	965 000	44 500	98 000	17.4	500	630	68/670
	900	103	6	675 000	1 460 000	68 500	149 000	16.7	480	560	69/670
	980	136	7.5	765 000	1 730 000	78 000	177 000	16.6	450	530	60/670
710	870	74	4	480 000	1 100 000	49 000	113 000	17.4	480	560	68/710
	950	106	6	715 000	1 640 000	72 500	167 000	16.8	450	530	69/710
750	920	78	5	525 000	1 260 000	53 500	128 000	17.4	430	530	68/750
	1 000	112	6	785 000	1 840 000	80 000	188 000	16.7	400	500	69/750
800	980	82	5	530 000	1 310 000	54 000	133 000	17.5	400	480	68/800
	1 060	115	6	825 000	2 050 000	84 500	209 000	16.8	380	450	69/800

Note (1) When heavy axial loads are applied, increase d_a and decrease D_a from the above values.

Bore Diameter 25 – 110 mm

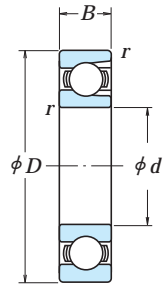

Open Type



Shielded Type
(One Shield) Z



Shielded Type
(Two Shields) ZZ

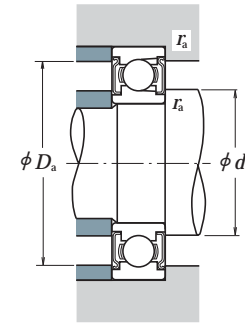
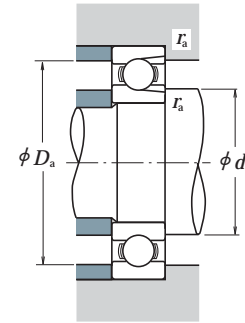

Boundary Dimensions (mm)				Basic Load Ratings (N) (kgf)				Limiting Speeds (min ⁻¹)		Open
d	D	B	r min.	C _r	C _{0r}	C _r	C _{0r}	Grease Open Z · ZZ	Oil Open Z	
25	52	15	1	14 400	10 500	1 470	1 070	12 000	15 000	BL 205 BL 305
	62	17	1.1	21 500	15 500	2 200	1 580	11 000	13 000	
30	62	16	1	21 000	16 300	2 150	1 660	10 000	12 000	BL 206 BL 306
	72	19	1.1	27 900	20 700	2 840	2 110	9 000	11 000	
35	72	17	1.1	27 800	22 100	2 830	2 250	9 000	11 000	BL 207 BL 307
	80	21	1.5	37 000	29 100	3 800	2 970	8 000	9 500	
40	80	18	1.1	35 500	28 800	3 600	2 940	8 000	9 500	BL 208 BL 308
	90	23	1.5	46 500	36 000	4 750	3 650	7 500	9 000	
45	85	19	1.1	37 000	32 000	3 800	3 250	7 500	9 000	BL 209 BL 309
	100	25	1.5	55 500	44 000	5 650	4 500	6 300	8 000	
50	90	20	1.1	39 000	35 000	3 950	3 550	6 700	8 500	BL 210 BL 310
	110	27	2	65 000	52 500	6 600	5 350	6 000	7 100	
55	100	21	1.5	48 000	44 000	4 900	4 500	6 300	7 500	BL 211 BL 311
	120	29	2	75 000	61 500	7 650	6 250	5 600	6 700	
60	110	22	1.5	58 000	54 000	5 950	5 550	5 600	6 700	BL 212 BL 312
	130	31	2.1	85 500	71 500	8 700	7 300	5 000	6 000	
65	120	23	1.5	63 500	60 000	6 450	6 150	5 300	6 300	BL 213 BL 313
	140	33	2.1	103 000	89 500	10 500	9 150	4 800	5 600	
70	125	24	1.5	69 000	66 000	7 050	6 750	5 000	6 000	BL 214 BL 314
	150	35	2.1	115 000	102 000	11 800	10 400	4 300	5 300	
75	130	25	1.5	72 000	72 000	7 350	7 300	4 500	5 600	BL 215 BL 315
	160	37	2.1	126 000	116 000	12 800	11 800	4 000	5 000	
80	140	26	2	84 000	85 000	8 600	8 650	4 300	5 300	BL 216 BL 316
	170	39	2.1	136 000	130 000	13 900	13 300	3 800	4 500	
85	150	28	2	93 000	93 000	9 500	9 450	4 000	5 000	BL 217 BL 317
	180	41	3	147 000	145 000	15 000	14 800	3 600	4 300	
90	160	30	2	107 000	107 000	10 900	10 900	3 800	4 500	BL 218 BL 318
	190	43	3	158 000	161 000	16 100	16 400	3 400	4 000	
95	170	32	2.1	121 000	123 000	12 300	12 500	3 600	4 300	BL 219 BL 319
	200	45	3	169 000	178 000	17 300	18 100	2 800	3 600	
100	180	34	2.1	136 000	140 000	13 800	14 200	3 400	4 000	BL 220
105	190	36	2.1	148 000	157 000	15 000	16 000	3 200	3 800	BL 221
110	200	38	2.1	160 000	176 000	16 300	17 900	2 800	3 400	BL 222

Bearing Numbers		Abutment and Fillet Dimensions (mm)				Mass (kg) approx.
With One Shielded	With Two Shields	d _a min.	d _b max.	D _a max.	r _a max.	
BL 205 Z	BL 205 ZZ	30	32	47	1	0.133
BL 305 Z	BL 305 ZZ	31.5	36	55.5	1	0.246
BL 206 Z	BL 206 ZZ	35	38.5	57	1	0.215
BL 306 Z	BL 306 ZZ	36.5	42	65.5	1	0.364
BL 207 Z	BL 207 ZZ	41.5	44.5	65.5	1	0.307
BL 307 Z	BL 307 ZZ	43	44.5	72	1.5	0.486
BL 208 Z	BL 208 ZZ	46.5	50	73.5	1	0.394
BL 308 Z	BL 308 ZZ	48	52.5	82	1.5	0.685
BL 209 Z	BL 209 ZZ	51.5	55.5	78.5	1	0.449
BL 309 Z	BL 309 ZZ	53	61.5	92	1.5	0.883
BL 210 Z	BL 210 ZZ	56.5	60	83.5	1	0.504
BL 310 Z	BL 310 ZZ	59	68	101	2	1.16
BL 211 Z	BL 211 ZZ	63	66.5	92	1.5	0.667
BL 311 Z	BL 311 ZZ	64	72.5	111	2	1.49
BL 212 Z	BL 212 ZZ	68	74.5	102	1.5	0.856
BL 312 Z	BL 312 ZZ	71	79	119	2	1.88
BL 213 Z	BL 213 ZZ	73	80	112	1.5	1.09
BL 313 Z	BL 313 ZZ	76	85.5	129	2	2.36
BL 214 Z	BL 214 ZZ	78	84	117	1.5	1.19
BL 314 Z	BL 314 ZZ	81	92	139	2	2.87
BL 215 Z	BL 215 ZZ	83	90	122	1.5	1.29
BL 315 Z	BL 315 ZZ	86	98.5	149	2	3.43
BL 216 Z	BL 216 ZZ	89	95.5	131	2	1.61
BL 316 Z	BL 316 ZZ	91	104.5	159	2	4.08
BL 217 Z	BL 217 ZZ	94	102	141	2	1.97
BL 317 Z	BL 317 ZZ	98	110.5	167	2.5	4.77
BL 218 Z	BL 218 ZZ	99	107.5	151	2	2.43
BL 318 Z	BL 318 ZZ	103	117	177	2.5	5.45
BL 219 Z	BL 219 ZZ	106	114	159	2	2.95
BL 319 Z	BL 319 ZZ	108	124	187	2.5	6.4
BL 220 Z	BL 220 ZZ	111	121.5	169	2	3.54
BL 221 Z	BL 221 ZZ	116	127.5	179	2	4.23
—	—	121	—	189	2	4.84

Remarks When using Maximum Type Ball Bearings, please contact NSK.

Bore Diameter 4 – 20 mm

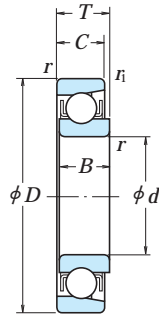

Outside Diameter Tolerance (Class N)
Units : μm

Nominal Outside Diameter D (mm)		Single Plane Mean Outside Diameter ΔD_{mp}			
		E Series		EN Series	
Over	Incl.	High	Low	High	Low
—	10	+ 8	0	0	- 8
10	18	+ 8	0	0	- 8
18	30	+ 9	0	0	- 9
30	50	+11	0	0	-11

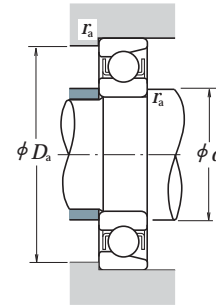

Dynamic Equivalent Load
 $P = XF_r + YF_a$

$F_a/F_r \leq e$		$F_a/F_r > e$		e
X	Y	X	Y	
1	0	0.5	2.5	0.2

Boundary Dimensions (mm)					Basic Load Ratings (N) (kgf)				Limiting Speeds (min ⁻¹)		Bearing Numbers	
d	D	B, C, T	r min.	r_1 min.	C_r	C_{0r}	C_r	C_{0r}	Grease	Oil	E Series	EN Series
4	16	5	0.15	0.1	1 650	288	168	29	34 000	40 000	E 4	EN 4
5	16	5	0.15	0.1	1 650	288	168	29	34 000	40 000	E 5	EN 5
6	21	7	0.3	0.15	2 490	445	254	46	30 000	36 000	E 6	EN 6
7	22	7	0.3	0.15	2 490	445	254	46	30 000	36 000	E 7	EN 7
8	24	7	0.3	0.15	3 450	650	350	66	28 000	34 000	E 8	EN 8
9	28	8	0.3	0.15	4 550	880	465	90	24 000	30 000	E 9	EN 9
10	28	8	0.3	0.15	4 550	880	465	90	24 000	30 000	E 10	EN 10
11	32	7	0.3	0.15	4 400	845	450	86	22 000	26 000	E 11	EN 11
12	32	7	0.3	0.15	4 400	845	450	86	22 000	26 000	E 12	EN 12
13	30	7	0.3	0.15	4 400	845	450	86	22 000	26 000	E 13	EN 13
14	35	8	0.3	0.15	5 800	1 150	590	117	19 000	22 000	—	EN 14
15	35	8	0.3	0.15	5 800	1 150	590	117	19 000	22 000	E 15	EN 15
	40	10	0.6	0.3	7 400	1 500	750	153	17 000	20 000	BO 15	—
16	38	10	0.6	0.2	6 900	1 380	705	141	17 000	22 000	—	EN 16
17	40	10	0.6	0.3	7 400	1 500	750	153	17 000	20 000	L 17	—
	44	11	0.6	0.3	7 350	1 500	750	153	16 000	19 000	—	EN 17
	44	11	0.6	0.3	7 350	1 500	750	153	16 000	19 000	BO 17	—
18	40	9	0.6	0.2	5 050	1 030	515	105	17 000	20 000	—	EN 18
19	40	9	0.6	0.2	5 050	1 030	515	105	17 000	20 000	E 19	EN 19
20	47	12	1	0.6	11 000	2 380	1 120	243	14 000	17 000	E 20	EN 20
	47	14	1	0.6	11 000	2 380	1 120	243	14 000	17 000	L 20	—

Abutment and Fillet Dimensions (mm)			Mass (kg) approx.
d_a min.	D_a max.	r_a max.	
5.2	14.8	0.15	0.005
6.2	14.8	0.15	0.004
8	19	0.3	0.011
9	20	0.3	0.013
10	22	0.3	0.014
11	26	0.3	0.022
12	26	0.3	0.021
13	30	0.3	0.029
14	30	0.3	0.028
15	28	0.3	0.021
16	33	0.3	0.035
17	33	0.3	0.034
19	36	0.6	0.055
20	34	0.6	0.049
21	36	0.6	0.051
21	40	0.6	0.080
21	40	0.6	0.080
22	36	0.6	0.051
23	36	0.6	0.049
25	42	1	0.089
25	42	1	0.101

- Remarks
1. The outside diameters of Magneto Bearings Series E always have plus tolerances.
 2. When using Magneto Bearings other than E, please contact NSK.

EXTRA SMALL BALL BEARINGS AND MINIATURE BALL BEARINGS

EXTRA SMALL BALL BEARINGS · MINIATURE BALL BEARINGS

Metric Design	Bore Diameter 1 – 9mm.....	B34
With Flange	Bore Diameter 1 – 9mm.....	B38
Inch Design	Bore Diameter 1.016 – 9.525mm.....	B42
With Flange	Bore Diameter 1.191 – 9.525mm.....	B44

DESIGN AND TYPES

The size ranges of extra small and miniature ball bearings are shown in Table 1. The design, types, and type symbols are shown in Table 2. Those types among them that are listed in the bearing tables are indicated by the shading in Table 2.

Table 1 Size Ranges of Bearings

Units : mm

Design	Extra Small Ball Bearings	Miniature Ball Bearings
Metric	Outside diameter $D \geq 9$ Bore diameter $d < 10$	Outside diameter $D < 9$
Inch	Outside diameter $D \geq 9.525$ Bore diameter $d < 10$	Outside diameter $D < 9.525$

Please refer to NSK Miniature Ball Bearings (CAT. No. E126) for details.

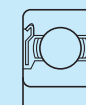

ZZ

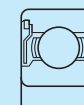

ZZS

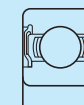

DD

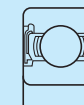

WV

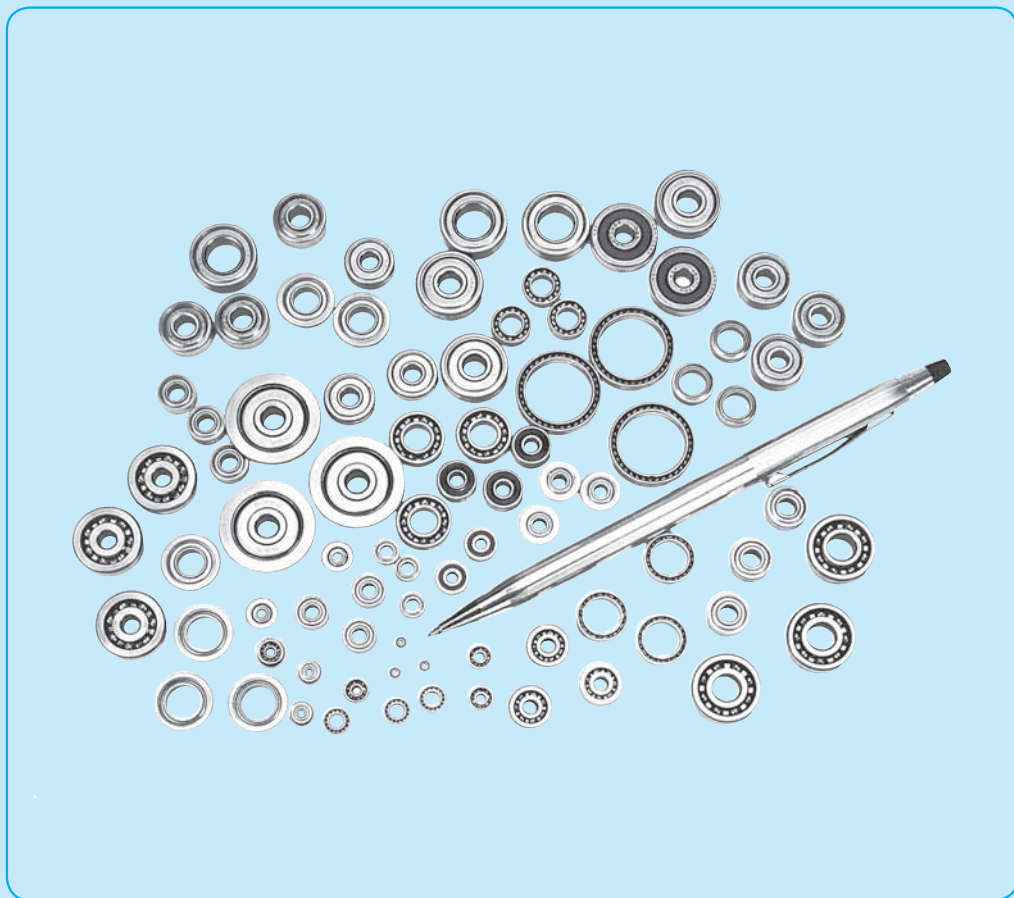

Table 2 Design, Types, and Type Symbols

Design · Types	Type Symbols				Remarks
	Metric	Inch	Special		
			Metric	Inch	
	6 0 0	R	MR	—	Shielded · sealed bearings are available.
Thin section 	—	—	SMT	—	
With flange 	F6 0 0	FR	MF	—	Shielded · sealed bearings are available.
Extended inner ring 	—	—	—	RW	Shielded bearings are available.
With flange and extended inner ring 	—	—	—	FRW	Shielded bearings are available.
For synchro motors 	—	—	—	SR00X00	Shielded bearings are available.
Pivot Ball Bearings 	—	—	BCF	—	
Thrust Ball Bearings 	—	—	F	—	

Remarks Single-row angular contact ball bearings are available besides those shown above.

TOLERANCES AND RUNNING ACCURACY

METRIC DESIGN BEARINGS Table 8.2(Pages A60 to A63)

The flange tolerances for metric design bearings are listed in Table 3.

Table 3 Flange Tolerances for Metric Flanged Bearings

(1) Tolerances of Flange Outside Diameter Units : μm

Nominal Flange Outside Diameter D_f (mm)		Deviation of Flange Outside Diameter ΔD_{fs}			
		①		②	
over	incl.	high	low	high	low
10	18	+220	-36	0	-36
10	18	+270	-43	0	-43
18	30	+330	-52	0	-52

Remarks ②is applied when the flange outside diameter is used for positioning.

(2) Flange Width Tolerances and Running Accuracies Related to Flange Units : μm

Nominal Bearing Outside Diameter D (mm)	Deviation of Flange Width ΔC_{1s}	Variation of Flange Width ΔC_{1s}			Variation of Bearing Outside Surface Generatrix Inclination with Flange Backface S_{D1}			Flange Backface Runout with Raceway S_{ea1}				
		Normal and Classes 6,5,4,2	Class 6	Class 5	Class 4	Class 2	Class 5	Class 4	Class 2			
over	incl.	high	low	max.			max.					
2.5(!)	6	Use the ΔB_s tolerance for d of the same bearing of the same class	Use the ΔV_{BS} tolerance for d of the same bearing of the same class	5	2.5	1.5	8	4	1.5	11	7	3
6	18			5	2.5	1.5	8	4	1.5	11	7	3
18	30			5	2.5	1.5	8	4	1.5	11	7	3

Notes (!) 2.5 mm is included

INCH DESIGN BEARINGS Table 8.2 (Pages A60 to A63)

The flange tolerances for inch design flanged bearings are listed in Table 8.8(2) (Pages A76 and A77).

INSTRUMENT BALL BEARINGS Table 8.8 (Pages A76 to A77)

RECOMMENDED FITS

Please refer to NSK Miniature Ball Bearings (CAT.No.E126).

INTERNAL CLEARANCES Table 9.10 (Page A89)

LIMITING SPEEDS

The limiting speeds listed in the bearing tables should be adjusted depending on the bearing load conditions. Also, higher speeds are attainable by making changes in the lubrication method, cage design, etc. Refer to Page A37 for detailed information.

Metric Design
Bore Diameter 1 – 4 mm

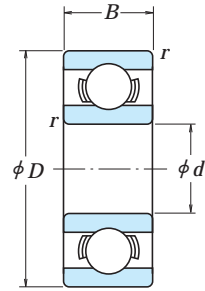

Open Type

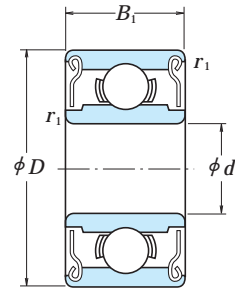

Shielded Type
ZZ · ZZ1

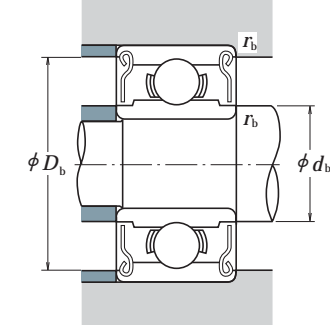
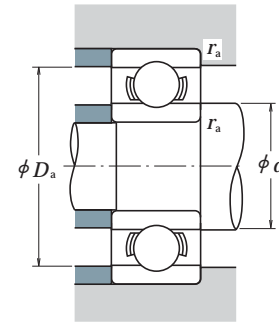

d	Boundary Dimensions (mm)					Basic Load Ratings (N) (kgf)				Limiting Speeds (min ⁻¹)		Open
	D	B	B ₁	r ⁽¹⁾ min.	r ₁ ⁽¹⁾ min.	C _r	C _{0r}	C _r	C _{0r}	Grease Open Z · ZZ	Oil Open Z	
1	3	1	—	0.05	—	80	23	8	2.5	130 000	150 000	681
	3	1.5	—	0.05	—	80	23	8	2.5	130 000	150 000	MR 31
	4	1.6	—	0.1	—	138	35	14	3.5	100 000	120 000	691
1.2	4	1.8	2.5	0.1	0.1	138	35	14	3.5	110 000	130 000	MR 41 X
1.5	4	1.2	2	0.05	0.05	112	33	11	3.5	100 000	120 000	681 X
	5	2	2.6	0.15	0.15	237	69	24	7	85 000	100 000	691 X
	6	2.5	3	0.15	0.15	330	98	34	10	75 000	90 000	601 X
2	5	1.5	2.3	0.08	0.08	169	50	17	5	85 000	100 000	682
	5	2	2.5	0.1	0.1	187	58	19	6	85 000	100 000	MR 52 B
	6	2.3	3	0.15	0.15	330	98	34	10	75 000	90 000	692
2.5	6	2.5	2.5	0.15	0.15	330	98	34	10	75 000	90 000	MR 62
	7	2.5	3	0.15	0.15	385	127	39	13	63 000	75 000	MR 72
	7	2.8	3.5	0.15	0.15	385	127	39	13	63 000	75 000	602
3	6	1.8	2.6	0.08	0.08	208	74	21	7.5	71 000	80 000	682 X
	7	2.5	3.5	0.15	0.15	385	127	39	13	63 000	75 000	692 X
	8	2.5	—	0.2	—	560	179	57	18	60 000	67 000	MR 82 X
4	8	2.8	4	0.15	0.15	550	175	56	18	60 000	71 000	602 X
	6	2	2.5	0.1	0.1	208	74	21	7.5	71 000	80 000	MR 63
	7	2	3	0.1	0.1	390	130	40	13	63 000	75 000	683 A
4	8	2.5	—	0.15	—	560	179	57	18	60 000	67 000	MR 83
	8	3	4	0.15	0.15	560	179	57	18	60 000	67 000	693
	9	2.5	4	0.2	0.15	570	187	58	19	56 000	67 000	MR 93
4	9	3	5	0.15	0.15	570	187	58	19	56 000	67 000	603
	10	4	4	0.15	0.15	630	218	64	22	50 000	60 000	623
	13	5	5	0.2	0.2	1 300	485	133	49	40 000	48 000	633
4	7	2	—	0.1	—	310	115	32	12	60 000	67 000	MR 74
	7	—	2.5	—	0.1	255	107	26	11	60 000	71 000	—
	8	2	3	0.15	0.1	395	139	40	14	56 000	67 000	MR 84
4	9	2.5	4	(0.15)	(0.15)	640	225	65	23	53 000	63 000	684 A
	10	3	4	0.2	0.15	710	270	73	28	50 000	60 000	MR 104 B
	11	4	4	0.15	0.15	960	345	98	35	48 000	56 000	694
4	12	4	4	0.2	0.2	960	345	98	35	48 000	56 000	604
	13	5	5	0.2	0.2	1 300	485	133	49	40 000	48 000	624
	16	5	5	0.3	0.3	1 730	670	177	68	36 000	43 000	634

Note (1) The values in parentheses are not based on ISO 15.

Remarks When using bearings with a rotating outer ring, please contact NSK if they are shielded.

Bearing Numbers		Abutment and Fillet Dimensions (mm)						Mass (g)	
Shielded	Sealed	d _a min.	d _b max.	D _a max.	D _b min.	r _a max.	r _b max.	Open	Shielded
—	—	1.4	—	2.6	—	0.05	—	0.03	—
—	—	1.4	—	2.6	—	0.05	—	0.04	—
—	—	1.8	—	3.2	—	0.1	—	0.09	—
MR 41 XZZ	—	2.0	1.9	3.2	3.5	0.1	0.1	0.10	0.14
681 XZZ	—	1.9	2.1	3.6	3.6	0.05	0.05	0.07	0.11
691 XZZ	—	2.7	2.5	3.8	4.3	0.15	0.15	0.17	0.20
601 XZZ	—	2.7	3.0	4.8	5.4	0.15	0.15	0.33	0.38
682 ZZ	—	2.6	2.7	4.4	4.2	0.08	0.08	0.12	0.17
MR 52 BZZ	—	2.8	2.7	4.2	4.4	0.1	0.1	0.16	0.23
692 ZZ	—	3.2	3.0	4.8	5.4	0.15	0.15	0.28	0.38
MR 62 ZZ	—	3.2	3.0	4.8	5.2	0.15	0.15	0.30	0.29
MR 72 ZZ	—	3.2	3.8	5.8	6.2	0.15	0.15	0.45	0.49
602 ZZ	—	3.2	3.8	5.8	6.2	0.15	0.15	0.51	0.58
682 XZZ	—	3.1	3.7	5.4	5.4	0.08	0.08	0.23	0.29
692 XZZ	—	3.7	3.8	5.8	6.2	0.15	0.15	0.41	0.55
—	—	4.1	—	6.4	—	0.2	—	0.56	—
602 XZZ	—	3.7	4.1	6.8	7.0	0.15	0.15	0.63	0.83
MR 63 ZZ	—	3.8	3.7	5.2	5.4	0.1	0.1	0.20	0.27
683 AZZ	—	3.8	4.0	6.2	6.4	0.1	0.1	0.32	0.45
—	—	4.2	—	6.8	—	0.15	—	0.54	—
693 ZZ	—	4.2	4.3	6.8	7.3	0.15	0.15	0.61	0.83
MR 93 ZZ	—	4.6	4.3	7.4	7.9	0.2	0.15	0.73	1.18
603 ZZ	—	4.2	4.3	7.8	7.9	0.15	0.15	0.87	1.45
623 ZZ	—	4.2	4.3	8.8	8.0	0.15	0.15	1.65	1.66
633 ZZ	—	4.6	6.0	11.4	11.3	0.2	0.2	3.38	3.33
—	—	4.8	—	6.2	—	0.1	—	0.22	—
MR 74 ZZ	—	—	4.8	—	6.3	—	0.1	—	0.29
MR 84 ZZ	—	5.2	5.0	6.8	7.4	0.15	0.1	0.36	0.56
684 AZZ	—	4.8	5.2	8.2	8.1	0.1	0.1	0.63	1.01
MR 104 BZZ	—	5.6	5.9	8.4	8.8	0.2	0.15	1.04	1.42
694 ZZ	—	5.2	5.6	9.8	9.9	0.15	0.15	1.7	1.75
604 ZZ	—	5.6	5.6	10.4	9.9	0.2	0.2	2.25	2.29
624 ZZ	—	5.6	6.0	11.4	11.3	0.2	0.2	3.03	3.04
634 ZZ1	—	6.0	7.5	14.0	13.8	0.3	0.3	5.24	5.21

Metric Design
Bore Diameter 5 – 9 mm

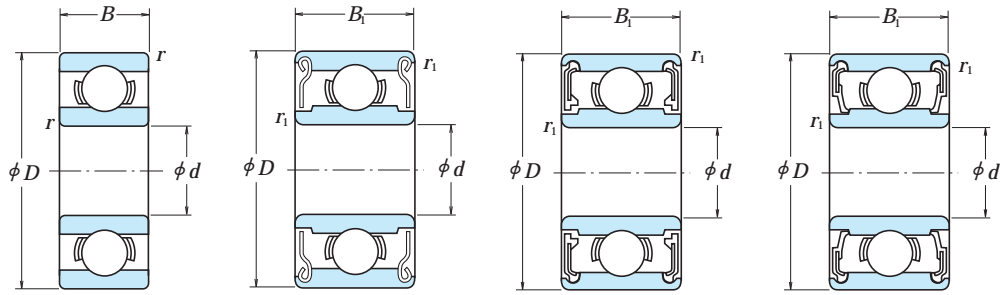

Open Type Shielded Type ZZ · ZZ1 Non-Contact Sealed Type VV Contact Sealed Type DD

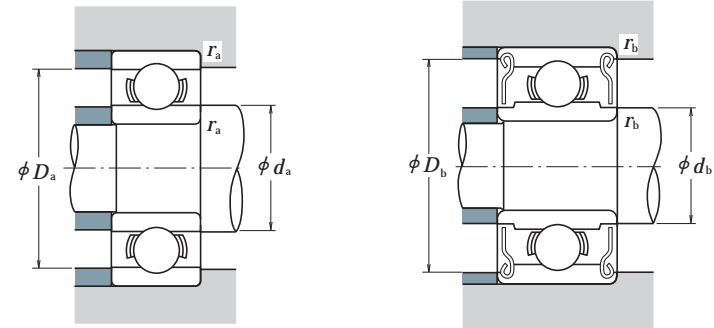

Boundary Dimensions (mm)						Basic Load Ratings (N)				Limiting Speeds (min ⁻¹)				Open
d	D	B	B ₁	r ⁽¹⁾ _{min.}	r ₁ ⁽¹⁾ _{min.}	C _r	C _{0r}	C _r	C _{0r}	Grease		Oil	Open	
											Open Z	Open		
5	8	2	—	0.1	—	310	120	31	12	53 000	—	63 000	MR 85	
	8	—	2.5	—	0.1	278	131	28	13	53 000	—	63 000	—	
	9	2.5	3	0.15	0.15	430	168	44	17	50 000	—	60 000	MR 95	
	10	3	4	0.15	0.15	430	168	44	17	50 000	—	60 000	MR 105	
	11	—	4	—	0.15	715	276	73	28	48 000	—	56 000	—	
	11	3	5	0.15	0.15	715	281	73	29	45 000	—	53 000	685	
	13	4	4	0.2	0.2	1 080	430	110	44	43 000	40 000	50 000	695	
	14	5	5	0.2	0.2	1 330	505	135	52	40 000	38 000	50 000	605	
	16	5	5	0.3	0.3	1 730	670	177	68	36 000	32 000	43 000	625	
	19	6	6	0.3	0.3	2 340	885	238	90	32 000	30 000	40 000	635	
6	10	2.5	3	0.15	0.1	495	218	51	22	45 000	—	53 000	MR 106	
	12	3	4	0.2	0.15	715	292	73	30	43 000	40 000	50 000	MR 126	
	13	3.5	5	0.15	0.15	1 080	440	110	45	40 000	38 000	50 000	686 A	
	15	5	5	0.2	0.2	1 730	670	177	68	40 000	36 000	45 000	696	
	17	6	6	0.3	0.3	2 260	835	231	85	38 000	34 000	45 000	606	
	19	6	6	0.3	0.3	2 340	885	238	90	32 000	30 000	40 000	626	
	22	7	7	0.3	0.3	3 300	1 370	335	140	30 000	28 000	36 000	636	
	17	5	5	0.3	0.3	1 610	710	164	73	36 000	28 000	43 000	697	
	19	6	6	0.3	0.3	2 340	885	238	90	36 000	32 000	43 000	607	
	22	7	7	0.3	0.3	3 300	1 370	335	140	30 000	28 000	36 000	627	
7	26	9	9	0.3	0.3	4 550	1 970	465	201	28 000	22 000	34 000	637	
	12	2.5	3.5	0.15	0.1	545	274	56	28	40 000	—	48 000	MR 128	
	14	3.5	4	0.2	0.15	820	385	83	39	38 000	32 000	45 000	MR 148	
	16	4	5	0.2	0.2	1 610	710	164	73	36 000	28 000	43 000	688 A	
	19	6	6	0.3	0.3	2 240	910	228	93	36 000	28 000	43 000	698	
	22	7	7	0.3	0.3	3 300	1 370	335	140	34 000	28 000	40 000	608	
	24	8	8	0.3	0.3	3 350	1 430	340	146	28 000	24 000	34 000	628	
	28	9	9	0.3	0.3	4 550	1 970	465	201	28 000	22 000	34 000	638	
	17	4	5	0.2	0.2	1 330	665	136	68	36 000	24 000	43 000	689	
	20	6	6	0.3	0.3	1 720	840	175	86	34 000	24 000	40 000	699	
9	24	7	7	0.3	0.3	3 350	1 430	340	146	32 000	24 000	38 000	609	
	26	8	8	(0.6)	(0.6)	4 550	1 970	465	201	28 000	22 000	34 000	629	
	30	10	10	0.6	0.6	5 100	2 390	520	244	24 000	—	30 000	639	

Note (1) The values in parentheses are not based on ISO 15.

Remarks 1. When using bearings with a rotating outer ring, please contact NSK if they are sealed or shielded.
2. Bearings with snap rings are also available, please contact NSK.

Bearing Numbers		Abutment and Fillet Dimensions (mm)						Mass (g)	
Shielded	Sealed	d _a _{min.}	d _b _{max.}	D _a _{max.}	D _b _{min.}	r _a _{max.}	r _b _{max.}	approx. Open	Shielded
—	—	5.8	—	7.2	—	0.1	—	0.26	—
MR 85 ZZ	—	—	5.8	—	7.4	—	0.1	—	0.34
MR 95 ZZ1	—	6.2	6.0	7.8	8.2	0.15	0.15	0.50	0.58
MR 105 ZZ	—	6.2	6.0	8.8	8.4	0.15	0.15	0.95	1.29
MR 115 ZZ	VV	—	6.3	—	9.8	—	0.15	—	1.49
685 ZZ	—	6.2	6.2	9.8	9.9	0.15	0.15	1.2	1.96
695 ZZ	VV DD	6.6	6.6	11.4	11.2	0.2	0.2	2.45	2.5
605 ZZ	— DD	6.6	6.9	12.4	12.2	0.2	0.2	3.54	3.48
625 ZZ1	VV DD	7.0	7.5	14.0	13.8	0.3	0.3	4.95	4.86
635 ZZ1	VV DD	7.0	8.5	17.0	16.5	0.3	0.3	8.56	8.34
MR 106 ZZ1	—	7.2	7.0	8.8	9.3	0.15	0.1	0.56	0.68
MR 126 ZZ	— DD	7.6	7.2	10.4	10.9	0.2	0.15	1.27	1.74
686 AZZ	VV DD	7.2	7.4	11.8	11.7	0.15	0.15	1.91	2.69
696 ZZ1	VV DD	7.6	7.9	13.4	13.3	0.2	0.2	3.88	3.72
606 ZZ	VV DD	8.0	8.2	15.0	14.8	0.3	0.3	5.97	6.08
626 ZZ1	VV DD	8.0	8.5	17.0	16.5	0.3	0.3	8.15	7.94
636 ZZ	VV DD	8.0	10.5	20.0	19.0	0.3	0.3	14	14
MR 117 ZZ	—	8.2	8.0	9.8	10.5	0.15	0.1	0.62	0.72
MR 137 ZZ	—	8.6	9.0	11.4	11.6	0.2	0.15	1.58	2.02
687 ZZ1	VV DD	8.2	8.5	12.8	12.7	0.15	0.15	2.13	2.97
697 ZZ1	VV DD	9.0	10.2	15.0	14.8	0.3	0.3	5.26	5.12
607 ZZ1	VV DD	9.0	9.1	17.0	16.5	0.3	0.3	7.67	7.51
627 ZZ	VV DD	9.0	10.5	20.0	19.0	0.3	0.3	12.7	12.9
637 ZZ1	VV DD	9.0	12.8	24.0	22.8	0.3	0.3	24	25
MR 128 ZZ1	—	9.2	9.0	10.8	11.3	0.15	0.1	0.71	0.97
MR 148 ZZ	VV DD	9.6	9.2	12.4	12.8	0.2	0.15	1.86	2.16
688 AZZ1	VV DD	9.6	10.2	14.4	14.2	0.2	0.2	3.12	4.02
698 ZZ	VV DD	10.0	10.0	17.0	16.5	0.3	0.3	7.23	7.18
608 ZZ	VV DD	10.0	10.5	20.0	19.0	0.3	0.3	12.1	12.2
628 ZZ	VV DD	10.0	12.0	22.0	20.5	0.3	0.3	17.2	17.4
638 ZZ1	VV DD	10.0	12.8	26.0	22.8	0.3	0.3	28.3	28.6
689 ZZ1	VV DD	10.6	11.5	15.4	15.2	0.2	0.2	3.53	4.43
699 ZZ1	VV DD	11.0	12.0	18.0	17.2	0.3	0.3	8.45	8.33
609 ZZ	VV DD	11.0	12.0	22.8	20.5	0.3	0.3	14.5	14.7
629 ZZ	VV DD	11.0	12.8	24.0	22.8	0.3	0.3	19.5	19.3
639 ZZ	VV	13.0	16.1	26.0	25.6	0.6	0.6	36.5	36

Metric Design With Flange
Bore Diameter 1 – 4 mm

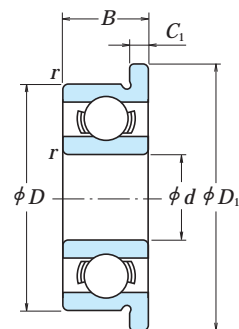

Open Type

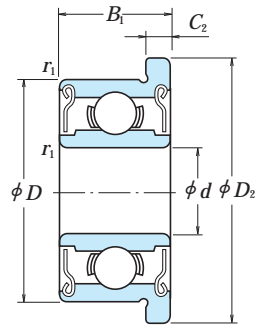

Shielded Type
ZZ · ZZ1

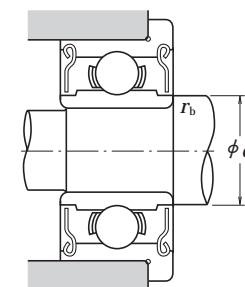
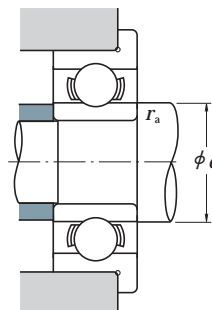

d	Boundary Dimensions (mm)								Basic Load Ratings (N)				Limiting Speeds (min ⁻¹)		
	D	D ₁	D ₂	B	B ₁	C ₁	C ₂	r ⁽¹⁾ min.	r ₁ ⁽¹⁾ min.	C _r	C _{0r}	C _r	C _{0r}	Grease Open Z · ZZ	Oil Open Z
1	3	3.8	—	1	—	0.3	—	0.05	—	80	23	8	2.5	130 000	150 000
	4	5	—	1.6	—	0.5	—	0.1	—	140	36	14	3.5	100 000	120 000
1.2	4	4.8	—	1.8	—	0.4	—	0.1	—	138	35	14	3.5	110 000	130 000
1.5	4	5	5	1.2	2	0.4	0.6	0.05	0.05	112	33	11	3.5	100 000	120 000
	5	6.5	6.5	2	2.6	0.6	0.8	0.15	0.15	237	69	24	7	85 000	100 000
6	7.5	7.5	2.5	3	0.6	0.8	0.15	0.15	330	98	34	10	75 000	90 000	
2	5	6.1	6.1	1.5	2.3	0.5	0.6	0.08	0.08	169	50	17	5	85 000	100 000
	5	6.2	6.2	2	2.5	0.6	0.6	0.1	0.1	187	58	19	6	85 000	100 000
6	7.5	7.5	2.3	3	0.6	0.8	0.15	0.15	330	98	34	10	75 000	90 000	
6	7.2	—	2.5	—	0.6	—	0.15	—	—	330	98	34	10	75 000	90 000
	7	8.2	8.2	2.5	3	0.6	0.6	0.15	0.15	385	127	39	13	63 000	75 000
	7	8.5	8.5	2.8	3.5	0.7	0.9	0.15	0.15	385	127	39	13	63 000	75 000
2.5	6	7.1	7.1	1.8	2.6	0.5	0.8	0.08	0.08	208	74	21	7.5	71 000	80 000
	7	8.5	8.5	2.5	3.5	0.7	0.9	0.15	0.15	385	127	39	13	63 000	75 000
	8	9.2	—	2.5	—	0.6	—	0.2	—	560	179	57	18	60 000	67 000
	8	9.5	9.5	2.8	4	0.7	0.9	0.15	0.15	550	175	56	18	60 000	71 000
3	6	7.2	7.2	2	2.5	0.6	0.6	0.1	0.1	208	74	21	7.5	71 000	80 000
	7	8.1	8.1	2	3	0.5	0.8	0.1	0.1	390	130	40	13	63 000	75 000
	8	9.2	—	2.5	—	0.6	—	0.15	—	560	179	57	18	60 000	67 000
	8	9.5	9.5	3	4	0.7	0.9	0.15	0.15	560	179	57	18	60 000	67 000
	9	10.2	10.6	2.5	4	0.6	0.8	0.2	0.15	570	187	58	19	56 000	67 000
	9	10.5	10.5	3	5	0.7	1	0.15	0.15	570	187	58	19	56 000	67 000
4	10	11.5	11.5	4	4	1	1	0.15	0.15	630	218	64	22	50 000	60 000
	13	15	15	5	5	1	1	0.2	0.2	1 300	485	133	49	36 000	43 000
	7	8.2	—	2	—	0.6	—	0.1	—	310	115	32	12	60 000	67 000
	7	—	8.2	—	2.5	—	0.6	—	0.1	255	107	26	11	60 000	71 000
	8	9.2	9.2	2	3	0.6	0.6	0.15	0.1	395	139	40	14	56 000	67 000
9	10.3	10.3	2.5	4	0.6	1	(0.15)	(0.15)	640	225	65	23	53 000	63 000	
10	11.2	11.6	3	4	0.6	0.8	0.2	0.15	710	270	73	28	50 000	60 000	
11	12.5	12.5	4	4	1	1	0.15	0.15	960	345	98	35	48 000	56 000	
12	13.5	13.5	4	4	1	1	0.2	0.2	960	345	98	35	48 000	56 000	
13	15	15	5	5	1	1	0.2	0.2	1 300	485	133	49	40 000	48 000	
16	18	18	5	5	1	1	0.3	0.3	1 730	670	177	68	36 000	43 000	

Note (1) The values in parentheses are not based on ISO 15.

Remarks When using bearings with a rotating outer ring, please contact NSK if they are shielded.

Bearing Numbers			Abutment and Fillet Dimensions (mm)				Mass (g)	
Open	Shielded	Sealed	d _a min.	d _b max.	r _a max.	r _b max.	approx. Open	Shielded
F 681	—	—	1.4	—	0.05	—	0.04	—
F 691	—	—	1.8	—	0.1	—	0.14	—
MF 41 X	—	—	2.0	—	0.1	—	0.12	—
F 681 X	F 681 XZZ	—	1.9	2.1	0.05	0.05	0.09	0.14
F 691 X	F 691 XZZ	—	2.7	2.5	0.15	0.15	0.23	0.28
F 601 X	F 601 XZZ	—	2.7	3.0	0.15	0.15	0.42	0.52
F 682	F 682 ZZ	—	2.6	2.7	0.08	0.08	0.16	0.22
MF 52 B	MF 52 BZZ	—	2.8	2.7	0.1	0.1	0.21	0.27
F 692	F 692 ZZ	—	3.2	3.0	0.15	0.15	0.35	0.48
MF 62	—	—	3.2	—	0.15	—	0.36	—
MF 72	MF 72 ZZ	—	3.2	3.8	0.15	0.15	0.52	0.56
F 602	F 602 ZZ	—	3.2	3.1	0.15	0.15	0.60	0.71
F 682 X	F 682 XZZ	—	3.1	3.7	0.08	0.08	0.25	0.36
F 692 X	F 692 XZZ	—	3.7	3.8	0.15	0.15	0.51	0.68
MF 82 X	—	—	4.1	—	0.2	—	0.62	—
F 602 X	F 602 XZZ	—	3.7	3.5	0.15	0.15	0.74	0.98
MF 63	MF 63 ZZ	—	3.8	3.7	0.1	0.1	0.27	0.33
F 683 A	F 683 AZZ	—	3.8	4.0	0.1	0.1	0.37	0.53
MF 83	—	—	4.2	—	0.15	—	0.56	—
F 693	F 693 ZZ	—	4.2	4.3	0.15	0.15	0.70	0.97
MF 93	MF 93 ZZ	—	4.6	4.3	0.2	0.15	0.81	1.34
F 603	F 603 ZZ	—	4.2	4.3	0.15	0.15	1.0	1.63
F 623	F 623 ZZ	—	4.2	4.3	0.15	0.15	1.85	1.86
F 633	F 633 ZZ	—	4.6	6.0	0.2	0.2	3.73	3.59
MF 74	—	—	4.8	—	0.1	—	0.29	—
—	MF 74 ZZ	—	—	4.8	—	0.1	—	0.35
MF 84	MF 84 ZZ	—	5.2	5.0	0.15	0.1	0.44	0.63
F 684	F 684 ZZ	—	4.8	5.2	0.1	0.1	0.70	1.14
MF 104 B	MF 104 BZZ	—	5.6	5.9	0.2	0.15	1.13	1.59
F 694	F 694 ZZ	—	5.2	5.6	0.15	0.15	1.91	1.96
F 604	F 604 ZZ	—	5.6	5.6	0.2	0.2	2.53	2.53
F 624	F 624 ZZ	—	5.6	6.0	0.2	0.2	3.38	3.53
F 634	F 634 ZZ1	—	6.0	7.5	0.3	0.3	5.73	5.62

Metric Design With Flange
Bore Diameter 5 – 9 mm

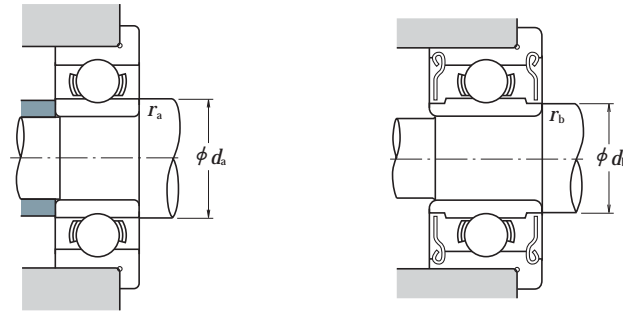
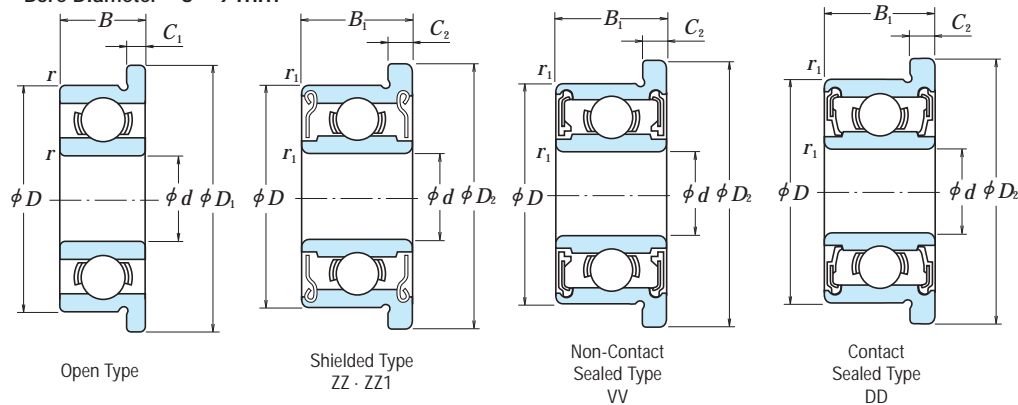

d	Boundary Dimensions (mm)							Basic Load Ratings (N) (kgf)				Limiting Speeds (min ⁻¹)				
	D	D ₁	D ₂	B	B ₁	C ₁	C ₂	r _{min.}	r _{1 min.}	C _r	C _{0r}	C _r	C _{0r}	Grease	Oil	
5	8	9.2	—	2	—	0.6	—	0.1	—	310	120	31	12	53 000	—	63 000
	8	—	9.2	—	2.5	—	0.6	—	0.1	278	131	28	13	53 000	—	63 000
	9	10.2	10.2	2.5	3	0.6	0.6	0.15	0.15	430	168	44	17	50 000	—	60 000
10	11.2	11.6	3	4	0.6	0.8	0.8	0.15	0.15	430	168	44	17	50 000	—	60 000
	11	12.5	12.5	3	5	0.8	1	0.15	0.15	715	281	73	29	45 000	—	53 000
	13	15	15	4	4	1	1	0.2	0.2	1 080	430	110	44	43 000	40 000	50 000
14	16	16	5	5	1	1	0.2	0.2	1 330	505	135	52	40 000	38 000	50 000	
	16	18	18	5	5	1	1	0.3	0.3	1 730	670	177	68	36 000	32 000	43 000
19	22	22	6	6	1.5	1.5	0.3	0.3	2 340	885	238	90	32 000	30 000	40 000	
	6	10	11.2	11.2	2.5	3	0.6	0.6	0.15	0.1	495	218	51	22	45 000	—
12		13.2	13.6	3	4	0.6	0.8	0.2	0.15	715	292	73	30	43 000	40 000	50 000
13		15	15	3.5	5	1	1.1	0.15	0.15	1 080	440	110	45	40 000	38 000	50 000
15	17	17	5	5	1.2	1.2	0.2	0.2	1 730	670	177	68	40 000	36 000	45 000	
	17	19	19	6	6	1.2	1.2	0.3	0.3	2 260	835	231	85	38 000	34 000	45 000
	19	22	22	6	6	1.5	1.5	0.3	0.3	2 340	885	238	90	32 000	30 000	40 000
	22	25	25	7	7	1.5	1.5	0.3	0.3	3 300	1 370	335	140	30 000	28 000	36 000
	7	11	12.2	12.2	2.5	3	0.6	0.6	0.15	0.1	455	201	47	21	43 000	—
13		14.2	14.6	3	4	0.6	0.8	0.2	0.15	540	276	55	28	40 000	—	48 000
14		16	16	3.5	5	1	1.1	0.15	0.15	1 170	510	120	52	40 000	34 000	45 000
17	19	19	5	5	1.2	1.2	0.3	0.3	1 610	715	164	73	36 000	28 000	43 000	
	19	22	22	6	6	1.5	1.5	0.3	0.3	2 340	885	238	90	36 000	32 000	43 000
	22	25	25	7	7	1.5	1.5	0.3	0.3	3 300	1 370	335	140	30 000	28 000	36 000
	8	12	13.2	13.6	2.5	3.5	0.6	0.8	0.15	0.1	545	274	56	28	40 000	—
14		15.6	15.6	3.5	4	0.8	0.8	0.2	0.15	820	385	83	39	38 000	32 000	45 000
16		18	18	4	5	1	1.1	0.2	0.2	1 610	710	164	73	36 000	30 000	43 000
19	22	22	6	6	1.5	1.5	0.3	0.3	2 240	910	228	93	36 000	28 000	43 000	
	22	25	25	7	7	1.5	1.5	0.3	0.3	3 300	1 370	335	140	34 000	28 000	40 000
9	17	19	19	4	5	1	1.1	0.2	0.2	1 330	665	136	68	36 000	24 000	43 000
	20	23	23	6	6	1.5	1.5	0.3	0.3	1 720	840	175	86	34 000	24 000	40 000

Bearing Numbers				Abutment and Fillet Dimensions (mm)				Mass (g)	
Open	Shielded	Sealed		d _{a min.}	d _{b max.}	r _{a max.}	r _{b max.}	approx.	
								Open	Shielded
MF 85	—	—	—	5.8	—	0.1	—	0.33	—
—	MF 85 ZZ	—	—	—	5.8	—	0.1	—	0.41
MF 95	MF 95 ZZ1	—	—	6.2	6.0	0.15	0.15	0.59	0.66
MF 105	MF 105 ZZ	—	—	6.2	6.0	0.15	0.15	1.05	1.46
F 685	F 685 ZZ	—	—	6.2	6.2	0.15	0.15	1.37	2.18
F 695	F 695 ZZ	VV	DD	6.6	6.6	0.2	0.2	2.79	2.84
F 605	F 605 ZZ	—	DD	6.6	6.9	0.2	0.2	3.9	3.85
F 625	F 625 ZZ1	VV	DD	7.0	7.5	0.3	0.3	5.37	5.27
F 635	F 635 ZZ1	VV	DD	7.0	8.5	0.3	0.3	9.49	9.49
MF 106	MF 106 ZZ1	—	—	7.2	7.0	0.15	0.1	0.65	0.77
MF 126	MF 126 ZZ	—	DD	7.6	7.2	0.2	0.15	1.38	1.94
F 686 A	F 686 AZZ	VV	DD	7.2	7.4	0.15	0.15	2.25	3.04
F 696	F 696 ZZ1	VV	DD	7.6	7.9	0.2	0.2	4.34	4.26
F 606	F 606 ZZ	VV	DD	8.0	8.2	0.3	0.3	6.58	6.61
F 626	F 626 ZZ1	VV	DD	8.0	8.5	0.3	0.3	9.09	9.09
F 636	F 636 ZZ	VV	DD	8.0	10.5	0.3	0.3	14.6	14.7
MF 117	MF 117 ZZ	—	—	8.2	8.0	0.15	0.1	0.72	0.82
MF 137	MF 137 ZZ	—	—	8.6	9.0	0.2	0.15	1.7	2.23
F 687	F 687 ZZ1	VV	DD	8.2	8.5	0.15	0.15	2.48	3.37
F 697	F 697 ZZ1	VV	DD	9.0	10.2	0.3	0.3	5.65	5.65
F 607	F 607 ZZ1	VV	DD	9.0	9.1	0.3	0.3	8.66	8.66
F 627	F 627 ZZ	VV	DD	9.0	10.5	0.3	0.3	14.2	14.2
MF 128	MF 128 ZZ1	—	—	9.2	9.0	0.15	0.1	0.82	1.15
MF 148	MF 148 ZZ	VV	DD	9.6	9.2	0.2	0.15	2.09	2.39
F 688 A	F 688 AZZ	VV	DD	9.6	10.2	0.2	0.2	3.54	4.47
F 698	F 698 ZZ	VV	DD	10.0	10.0	0.3	0.3	8.35	8.3
F 608	F 608 ZZ	VV	DD	10.0	10.5	0.3	0.3	13.4	13.5
F 689	F 689 ZZ1	VV	DD	10.6	11.5	0.2	0.2	3.97	4.91
F 699	F 699 ZZ1	VV	DD	11.0	12.0	0.3	0.3	9.51	9.51

Remarks When using bearings with a rotating outer ring, please contact NSK if they are shielded.

Inch Design
Bore Diameter 1.016 – 9.525 mm

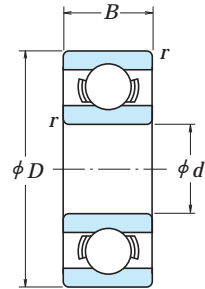

Open Type

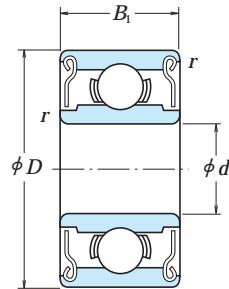

Shielded Type
ZZ · ZS

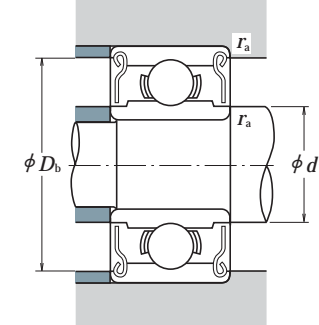
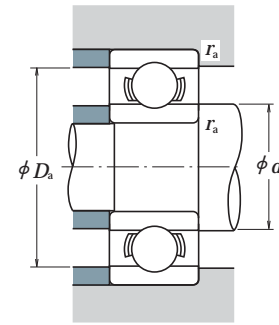

d	Boundary Dimensions (mm)				Basic Load Ratings (N)				Limiting Speeds (min ⁻¹)		Bearing Open
	D	B	B ₁	r min.	C _r	C _{0r}	C _r	C _{0r}	Grease Open Z · ZZ	Oil Open Z	
1.016	3.175	1.191	—	0.1	80	23	8	2.5	130 000	150 000	R 09
1.191	3.967	1.588	2.380	0.1	138	35	14	3.5	110 000	130 000	R 0
1.397	4.762	1.984	2.779	0.1	231	66	24	6.5	90 000	110 000	R 1
1.984	6.350	2.380	3.571	0.1	310	108	32	11	67 000	80 000	R 1-4
2.380	4.762	1.588	—	0.1	188	60	19	6	80 000	95 000	R 133
	4.762	—	2.380	0.1	143	52	15	5.5	80 000	95 000	—
	7.938	2.779	3.571	0.15	550	175	56	18	60 000	71 000	R 1-5
3.175	6.350	2.380	2.779	0.1	283	95	29	9.5	67 000	80 000	R 144
	7.938	2.779	3.571	0.1	560	179	57	18	60 000	67 000	R 2-5
	9.525	2.779	3.571	0.15	640	225	65	23	53 000	63 000	R 2-6
3.967	9.525	3.967	3.967	0.3	630	218	64	22	56 000	67 000	R 2
	12.700	4.366	4.366	0.3	640	225	65	23	53 000	63 000	R 2A
4.762	7.938	2.779	3.175	0.1	360	149	37	15	53 000	63 000	R 155
	9.525	3.175	3.175	0.1	710	270	73	28	50 000	60 000	R 156
	12.700	3.967	4.978	0.3	1 300	485	133	49	43 000	53 000	R 166 R 3
6.350	9.525	3.175	3.175	0.1	420	204	43	21	48 000	56 000	R 168B
	12.700	3.175	4.762	0.15	1 080	440	110	45	40 000	50 000	R 188
	15.875	4.978	4.978	0.3	1 610	660	164	68	38 000	45 000	R 4B
7.938	19.050	5.558	7.142	0.4	2 620	1 060	267	108	36 000	43 000	R 4AA
	12.700	3.967	3.967	0.15	540	276	55	28	40 000	48 000	R 1810
9.525	22.225	5.558	7.142	0.4	3 350	1 410	340	144	32 000	38 000	R 6

Remarks 1. When using bearings with a rotating outer ring, please contact NSK if they are shielded.
2. Bearings with double shields (ZZ, ZS) are also available with single shields (Z, ZS).

Numbers	Abutment and Fillet Dimensions (mm)					Mass (g)		
	Shielded	d _a min.	d _b max.	D _a max.	D _b min.	r _a max.	Open	approx. Shielded
—	—	1.9	—	2.3	—	0.1	0.04	—
R 0 ZZ	—	2.0	1.9	3.1	3.5	0.1	0.09	0.11
R 1 ZZ	—	2.2	2.3	3.9	4.1	0.1	0.15	0.19
R 1-4 ZZ	—	2.8	3.9	5.5	5.9	0.1	0.35	0.50
—	—	3.2	—	3.9	—	0.1	0.10	—
R 133 ZS	—	—	3.0	—	4.2	0.1	—	0.13
R 1-5 ZZ	—	3.6	4.1	6.7	7.0	0.15	0.60	0.72
R 144 ZZ	—	4.0	3.9	5.5	5.9	0.1	0.25	0.27
R 2-5 ZZ	—	4.0	4.3	7.1	7.3	0.1	0.55	0.72
R 2-6 ZS	—	4.4	4.6	8.3	8.2	0.15	0.96	1.13
R 2 ZZ	—	5.2	4.8	7.5	8.0	0.3	1.36	1.39
R 2A ZZ	—	5.2	4.6	10.7	8.2	0.3	3.3	3.23
R 155 ZS	—	4.8	5.5	7.1	7.3	0.1	0.51	0.56
R 156 ZS	—	5.6	5.5	7.1	7.3	0.1	0.39	0.42
R 166 ZZ	—	5.6	5.9	8.7	8.8	0.1	0.81	0.85
R 3 ZZ	—	6.8	6.5	10.7	11.2	0.3	2.21	2.79
R 168 BZZ	—	7.2	7.0	8.7	8.9	0.1	0.58	0.62
R 188 ZZ	—	7.6	7.4	11.5	11.6	0.15	1.53	2.21
R 4B ZZ	—	8.4	8.4	13.8	13.8	0.3	4.5	4.43
R 4AA ZZ	—	9.4	9.0	16.0	16.6	0.4	7.48	9.17
R 1810 ZZ	—	9.2	9.0	11.5	11.6	0.15	1.56	1.48
R 6 ZZ	—	12.6	11.9	19.2	20.0	0.4	9.02	11

Inch Design With Flange
 Bore Diameter 1.191 – 9.525 mm

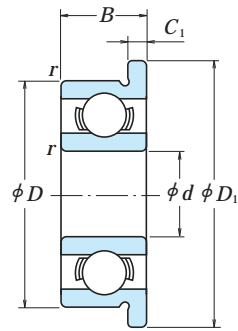

Open Type

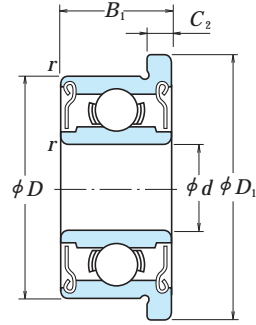

Shielded Type
 ZZ · ZS

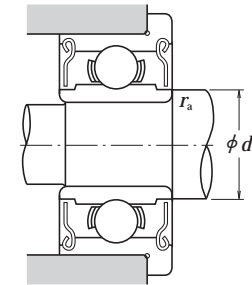
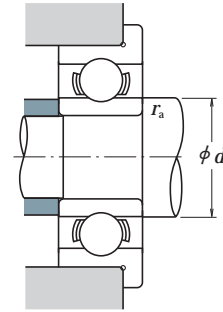

d	Boundary Dimensions (mm)							Basic Load Ratings (N) (kgf)			
	D	D ₁	B	B ₁	C ₁	C ₂	r min.	C _r	C _{0r}	C _r	C _{0r}
1.191	3.967	5.156	1.588	2.380	0.330	0.790	0.1	138	35	14	3.5
1.397	4.762	5.944	1.984	2.779	0.580	0.790	0.1	231	66	24	6.5
1.984	6.350	7.518	2.380	3.571	0.580	0.790	0.1	310	108	32	11
2.380	4.762	5.944	1.588	—	0.460	—	0.1	188	60	19	6
	4.762	5.944	—	2.380	—	0.790	0.1	143	52	15	5.5
	7.938	9.119	2.779	3.571	0.580	0.790	0.15	550	175	56	18
3.175	6.350	7.518	2.380	2.779	0.580	0.790	0.1	283	95	29	9.5
	7.938	9.119	2.779	3.571	0.580	0.790	0.1	560	179	57	18
	9.525	10.719	2.779	3.571	0.580	0.790	0.15	640	225	65	23
	9.525	11.176	3.967	3.967	0.760	0.760	0.3	630	218	64	22
3.967	7.938	9.119	2.779	3.175	0.580	0.910	0.1	360	149	37	15
4.762	7.938	9.119	2.779	3.175	0.580	0.910	0.1	360	149	37	15
	9.525	10.719	3.175	3.175	0.580	0.790	0.1	710	270	73	28
	12.700	14.351	4.978	4.978	1.070	1.070	0.3	1 300	485	133	49
6.350	9.525	10.719	3.175	3.175	0.580	0.910	0.1	420	204	43	21
	12.700	13.894	3.175	4.762	0.580	1.140	0.15	1 080	440	110	45
	15.875	17.526	4.978	4.978	1.070	1.070	0.3	1 610	660	164	68
7.938	12.700	13.894	3.967	3.967	0.790	0.790	0.15	540	276	55	28
9.525	22.225	24.613	7.142	7.142	1.570	1.570	0.4	3 350	1 410	340	144

Limiting Speeds (min ⁻¹)		Bearing Numbers		Abutment and Fillet Dimensions (mm)			Mass (g)	
Grease Open Z · ZZ	Oil Open Z	Open	Shielded	d _a min.	d _b max.	r _a max.	Open approx.	Shielded
110 000	130 000	FR 0	FR 0 ZZ	2.0	1.9	0.1	0.11	0.16
90 000	110 000	FR 1	FR 1 ZZ	2.2	2.3	0.1	0.20	0.25
67 000	80 000	FR 1-4	FR 1-4 ZZ	2.8	3.9	0.1	0.41	0.58
80 000	95 000	FR 133	—	3.2	—	0.1	0.13	—
80 000	95 000	—	FR 133 ZS	—	3.0	0.1	—	0.19
60 000	71 000	FR 1-5	FR 1-5 ZZ	3.6	4.1	0.15	0.68	0.82
67 000	80 000	FR 144	FR 144 ZZ	4.0	3.9	0.1	0.31	0.35
60 000	67 000	FR 2-5	FR 2-5 ZZ	4.0	4.3	0.1	0.62	0.81
53 000	63 000	FR 2-6	FR 2-6 ZS	4.4	4.6	0.15	1.04	1.25
56 000	67 000	FR 2	FR 2 ZZ	5.2	4.8	0.3	1.51	1.55
53 000	63 000	FR 155	FR 155 ZS	4.8	5.5	0.1	0.59	0.67
53 000	63 000	FR 156	FR 156 ZS	5.6	5.5	0.1	0.47	0.53
50 000	60 000	FR 166	FR 166 ZZ	5.6	5.9	0.1	0.90	0.98
43 000	53 000	FR 3	FR 3 ZZ	6.8	6.5	0.3	2.97	3.09
48 000	56 000	FR 168B	FR 168 BZZ	7.2	7.0	0.1	0.66	0.75
40 000	50 000	FR 188	FR 188 ZZ	7.6	7.4	0.15	1.64	2.49
38 000	45 000	FR 4B	FR 4B ZZ	8.4	8.4	0.3	4.78	4.78
40 000	48 000	FR 1810	FR 1810 ZZ	9.2	9.0	0.15	1.71	1.63
32 000	38 000	FR 6	FR 6 ZZ	12.6	11.9	0.4	10.1	12.1

Remarks 1. When using bearings with a rotating outer ring, please contact NSK if they are shielded.
 2. Bearings with double shields (ZZ, ZS) are also available with single shields (Z, ZS).

ANGULAR CONTACT BALL BEARINGS

SINGLE-ROW AND MATCHED ANGULAR CONTACT BALL BEARINGS

Bore Diameter 10 – 65mm	B50
Bore Diameter 70 – 120mm	B60
Bore Diameter 130 – 200mm	B66

DOUBLE-ROW ANGULAR CONTACT BALL BEARINGS

Bore Diameter 10 – 85mm	B70
-------------------------	-----

FOUR-POINT CONTACT BALL BEARINGS

Bore Diameter 30 – 200mm	B72
--------------------------	-----

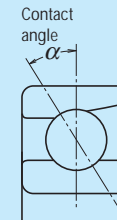

DESIGN, TYPES, AND FEATURES

SINGLE-ROW ANGULAR CONTACT BALL BEARINGS

Since these bearings have a contact angle, they can sustain significant axial loads in one direction together with radial loads. Because of their design, when a radial load is applied, an axial force component is produced; therefore, two opposed bearings or a combination of more than two must be used.

Since the rigidity of single-row angular contact ball bearings can be increased by preloading, they are often used in the main spindles of machine tools, for which high running accuracy is required. (Refer to Chapter 10, Preload, Page A96).

Usually, the cages for angular contact ball bearings with a contact angle of 30° (Symbol A) or 40° (Symbol B) are in accordance with Table 1, but depending on the application, machined synthetic resin cages or molded polyamide resin cages are also used. The basic load ratings given in the bearing tables are based on the cage classification listed in Table 1.

Though the figures in the bearing tables (Pages B50 to B65; bearing bore diameters of 10 to 120) show bearings with single-shoulder-type inner rings, both-shoulder-type bearings are also available. Please consult NSK for more detailed information.

Table 1 Standard Cages for Angular Contact Ball Bearings

Series	Pressed Steel Cages	Machined Brass Cages
79A5, C	—	7900 – 7940
70A	7000 – 7018	7019 – 7040
70C	—	7000 – 7022
72A, B	7200 – 7222	7224 – 7240
72C	—	7200 – 7240
73A, B	7300 – 7320	7321 – 7340

In addition, for bearings with the same serial number, if the type of cages are different, the number of balls may also be different. In such a case, the load rating will differ from the one listed in the bearing tables.

Angular Contact Ball Bearings with contact angles of 15° (Symbol C) and 25° (Symbol A5) are primarily for high precision or high speed applications, and machined brass or synthetic resin cages or molded polyamide cages are used.

The maximum operating temperature of molded polyamide cages is 120°C.

MATCHED ANGULAR CONTACT BALL BEARINGS

The types and features of matched angular contact ball bearings are shown in Table 2.

Table 2 Types and Features of Matched Angular Contact Ball Bearings

Figure	Arrangement	Features
	Back-to-back (DB) (Example) 7208 A DB	Radial loads and axial loads in both directions can be sustained. Since the distance between the effective load centers a_0 is big, this type is suitable if moments are applied.
	Face-to-face (DF) (Example) 7208 B DF	Radial loads and axial loads in both directions can be sustained. Compared with the DB Type, the distance between the effective load centers is small, so the capacity to sustain moments is inferior to the DB Type.
	Tandem (DT) (Example) 7208 A DT	Radial loads and axial loads in one direction can be sustained. Since two bearings share the axial load, this arrangement is used when the load in one direction is heavy.

NSKHPS ANGULAR CONTACT BALL BEARINGS

In comparison with standard angular contact ball bearings, these bearings have high capacity, high limiting speed, and highly accurate universal matching as the features. The molded polyamide cages are standard specification for the HPS type.

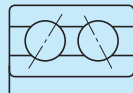

DOUBLE-ROW ANGULAR CONTACT BALL BEARINGS

This is basically a back-to-back mounting of two single-row angular contact ball bearings, but their inner and outer rings are each integrated into one. Axial loads in both directions can be sustained, and the capacity to sustain moments is good. This type is used as fixed-end bearings.

Their cages are pressed steel.

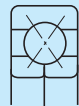

FOUR-POINT CONTACT BALL BEARINGS

The inner ring is split radially into two pieces. Their design allows one bearing to sustain significant axial loads in either direction.

The contact angle is 35°, so the axial load capacity is high. This type is suitable for carrying pure axial loads or combined loads where the axial loads are high.

The cages are made of machined brass.

PRECAUTIONS FOR USE OF ANGULAR CONTACT BALL BEARINGS

Under severe operating conditions where the speed and temperature are close to their limits, lubrication is marginal, vibration and moment loads are heavy, they may not be suitable, particularly for certain types of cages. In such a case, please consult with NSK beforehand.

And if the load on angular contact ball bearings becomes too small, or if the ratio of the axial and radial loads for matched bearings exceeds 'e' (e is listed in the bearings tables) during operation, slippage occurs between the balls and raceways, which may result in smearing. Especially with large bearings since the weight of the balls and cage is high. If such load conditions are expected, please consult with NSK for selection of the bearings.

TOLERANCES AND RUNNING ACCURACY

SINGLE-ROW ANGULAR CONTACT

BALL BEARINGS..... Table 8.2 (Pages A60 to A63)

NSKHPS ANGULAR CONTACT BALL BEARINGS

Tolerance for Dimensions: Class 6,
Running Accuracy: Class 5..... Table 8.2 (Pages A60 to A63)

MATCHED ANGULAR CONTACT

BALL BEARINGS..... Table 8.2 (Pages A60 to A63)

DOUBLE-ROW ANGULAR CONTACT

BALL BEARINGS..... Table 8.2 (Pages A60 to A63)

FOUR-POINT CONTACT BALL

BEARINGS..... Table 8.2 (Pages A60 to A63)

RECOMMENDED FITS

SINGLE-ROW ANGULAR CONTACT BALL BEARINGS AND HPS ANGULAR CONTACT BALL BEARINGS.....

Table 9.2 (Page A84)

Table 9.4 (Page A85)

MATCHED ANGULAR CONTACT BALL BEARINGS..... Table 9.2 (Page A84)

Table 9.4 (Page A85)

DOUBLE-ROW ANGULAR CONTACT BALL BEARINGS.....

Table 9.2 (Page A84)

Table 9.4 (Page A85)

FOUR-POINT CONTACT BALL BEARINGS..... Table 9.2 (Page A84)

Table 9.4 (Page A85)

INTERNAL CLEARANCES

MATCHED ANGULAR CONTACT BALL BEARINGS..... Table 9.17 (Page A94)

Matched angular contact ball bearings with precision better than P5 are primarily used in the main spindles of machine tools, so they are used with a preload for rigidity. For convenience of selection, internal clearances are adjusted to produce Very Light, Light, Medium, and Heavy Preloads. Their fitting is also special. Concerning these matters, please refer to Tables 10.1 and 10.2 (Pages A98 and A99).

The clearance (or preload) of matched bearings is obtained by axially tightening a pair of bearings till the side faces of their inner or outer rings are pressed against each other.

NSKHPS ANGULAR CONTACT BALL BEARINGS

Axial Internal Clearance (Measured Clearances) Units : μm

Nominal Bore Diameter d (mm)		Axial Internal Clearance			
over	incl.	CNB		GA	
		min.	max.	min.	max.
12	18	17	25	-2	6
18	30	20	28		
30	50	24	32		
50	80	29	41	-3	9

DOUBLE-ROW ANGULAR CONTACT BALL BEARINGS

For the clearance in double-row angular contact ball bearings, please consult with NSK.

FOUR-POINT CONTACT BALL BEARINGS..... Table 9.18 (Page A94)

LIMITING SPEEDS

In cases of single-row and matched angular contact ball bearings, the Limiting speeds listed in the bearing table are for bearings with machined cage. For those with pressed cages, the listed speeds must be reduced by 20%.

The limiting speeds of bearings with contact angles of 15° (Symbol C) and 25° (Symbol A5) are for bearings with precision of P5 and better (with machined synthetic-resin cages or molded polyamide cages).

The limiting speeds listed in the bearing tables should be adjusted depending on the bearing load conditions. Also, higher speeds are attainable by making changes in the lubrication method, cage design, etc. Refer to Page A37 for detailed information.

SINGLE/MATCHED MOUNTINGS

Bore Diameter 10 – 15 mm

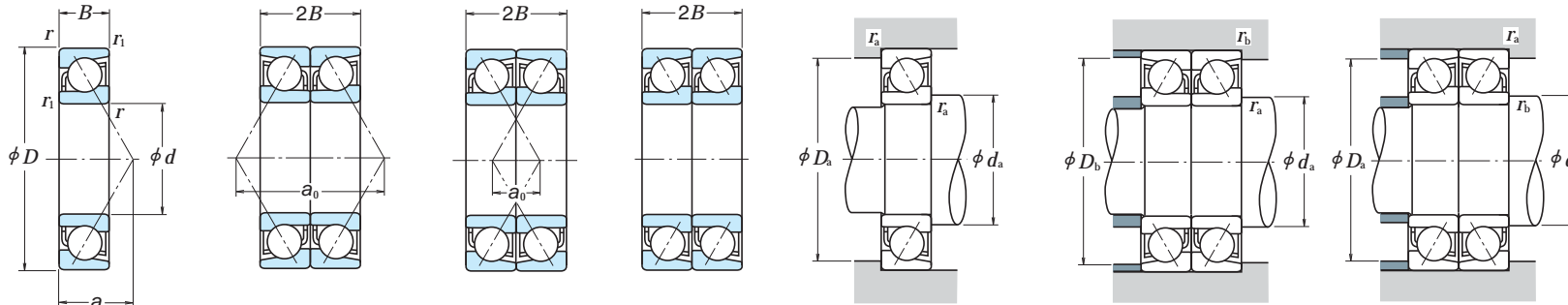

Dynamic Equivalent Load $P = X F_r + Y F_a$

Contact Angle	$i \frac{L_0 F_a}{C_{or}}$	e	Single, DT				DB or DF			
			$F_a/F_r \leq e$		$F_a/F_r > e$		$F_a/F_r \leq e$		$F_a/F_r > e$	
			X	Y	X	Y	X	Y	X	Y
15°	0.178	0.38	1	0	0.44	1.47	1	1.65	0.72	2.39
	0.357	0.40	1	0	0.44	1.40	1	1.57	0.72	2.28
	0.714	0.43	1	0	0.44	1.30	1	1.46	0.72	2.11
	1.07	0.46	1	0	0.44	1.23	1	1.38	0.72	2.00
	1.43	0.47	1	0	0.44	1.19	1	1.34	0.72	1.93
	2.14	0.50	1	0	0.44	1.12	1	1.26	0.72	1.82
	3.57	0.55	1	0	0.44	1.02	1	1.14	0.72	1.66
	5.35	0.56	1	0	0.44	1.00	1	1.12	0.72	1.63
25°	—	0.68	1	0	0.41	0.87	1	0.92	0.67	1.41
30°	—	0.80	1	0	0.39	0.76	1	0.78	0.63	1.24
40°	—	1.14	1	0	0.35	0.57	1	0.55	0.57	0.93

*For i , use 2 for DB, DF and 1 for DT

Static Equivalent Load $P_0 = X_0 F_r + Y_0 F_a$

Contact Angle	Single, DT		DB or DF		Single or DT mounting When $F_r > 0.5 F_r + Y_0 F_a$ use $P_0 = F_r$
	X_0	Y_0	X_0	Y_0	
15°	0.5	0.46	1	0.92	
25°	0.5	0.38	1	0.76	
30°	0.5	0.33	1	0.66	
40°	0.5	0.26	1	0.52	

Boundary Dimensions (mm)	Basic Load Ratings (Single) (N)				Factor f_0	Limiting Speeds (1) (min ⁻¹)		Eff. Load Centers (mm) a	Abutment and Fillet Dimensions (mm)			Mass (kg) approx.				
	d	D	B	$r_{1 \min.}$		C_r	C_{0r}		Grease	Oil	$d_a \min.$		$D_a \max.$	$r_a \max.$		
10	22	6	0.3	0.15	2 880	1 450	294	148	—	40 000	56 000	6.7	12.5	19.5	0.3	0.009
	22	6	0.3	0.15	3 000	1 520	305	155	14.1	48 000	63 000	5.1	12.5	19.5	0.3	0.009
	26	8	0.3	0.15	5 350	2 600	550	266	—	32 000	43 000	9.2	12.5	23.5	0.3	0.019
	26	8	0.3	0.15	5 300	2 490	540	254	12.6	45 000	63 000	6.4	12.5	23.5	0.3	0.021
	30	9	0.6	0.3	5 400	2 710	555	276	—	28 000	38 000	10.3	15	25	0.6	0.032
	30	9	0.6	0.3	5 000	2 500	510	255	—	20 000	28 000	12.9	15	25	0.6	0.032
	30	9	0.6	0.3	5 400	2 610	550	266	13.2	40 000	56 000	7.2	15	25	0.6	0.036
	35	11	0.6	0.3	9 300	4 300	950	440	—	20 000	26 000	12.0	15	30	0.6	0.053
	35	11	0.6	0.3	8 750	4 050	890	410	—	18 000	24 000	14.9	15	30	0.6	0.054
	12	24	6	0.3	0.15	3 200	1 770	325	181	—	38 000	53 000	7.2	14.5	21.5	0.3
24		6	0.3	0.15	3 350	1 860	340	189	14.7	45 000	63 000	5.4	14.5	21.5	0.3	0.011
28		8	0.3	0.15	5 800	2 980	590	305	—	28 000	38 000	9.8	14.5	25.5	0.3	0.021
28		8	0.3	0.15	5 800	2 900	590	296	13.2	40 000	56 000	6.7	14.5	25.5	0.3	0.024
32		10	0.6	0.3	8 000	4 050	815	410	—	26 000	34 000	11.4	17	27	0.6	0.037
32		10	0.6	0.3	7 450	3 750	760	380	—	18 000	26 000	14.2	17	27	0.6	0.038
32		10	0.6	0.3	8 150	3 750	830	380	—	20 000	30 000	14.2	17	27	0.6	0.036
32		10	0.6	0.3	7 900	3 850	805	395	12.5	36 000	50 000	7.9	17	27	0.6	0.041
37		12	1	0.6	9 450	4 500	965	460	—	18 000	24 000	13.1	18	31	1	0.060
37		12	1	0.6	8 850	4 200	900	425	—	16 000	22 000	16.3	18	31	1	0.062
15	28	7	0.3	0.15	4 550	2 530	465	258	—	32 000	43 000	8.5	17.5	25.5	0.3	0.015
	28	7	0.3	0.15	4 750	2 640	485	270	14.5	38 000	53 000	6.4	17.5	25.5	0.3	0.015
	32	9	0.3	0.15	6 100	3 450	625	350	—	24 000	32 000	11.3	17.5	29.5	0.3	0.030
	32	9	0.3	0.15	6 250	3 400	635	345	14.1	34 000	48 000	7.6	17.5	29.5	0.3	0.034
	35	11	0.6	0.3	8 650	4 650	880	475	—	22 000	30 000	12.7	20	30	0.6	0.045
	35	11	0.6	0.3	7 950	4 300	810	440	—	16 000	22 000	16.0	20	30	0.6	0.046
	35	11	0.6	0.3	9 800	4 800	995	490	—	18 000	26 000	16.0	20	30	0.6	0.044
	35	11	0.6	0.3	8 650	4 550	885	460	13.2	32 000	45 000	8.8	20	30	0.6	0.052
	42	13	1	0.6	13 400	7 100	1 370	720	—	16 000	22 000	14.7	21	36	1	0.084
	42	13	1	0.6	12 500	6 600	1 270	670	—	14 000	19 000	18.5	21	36	1	0.086
42	13	1	0.6	14 300	6 900	1 460	705	—	16 000	22 000	18.5	21	36	1	0.084	

Notes (1) For applications operating near the limiting speed, refer to Page B49.
 (2) The suffixes A, A5, B, and C represent contact angles of 30°, 25°, 40°, and 15° respectively.

Bearing Numbers (°)	Basic Load Ratings (Matched) (kgf)				Limiting Speeds (1) (Matched) (min ⁻¹)		Load Center Spacings (mm) a_0		Abutment and Fillet Dimensions (mm)				
	Single	Duplex	C_r	C_{0r}	Grease	Oil	DB	DF	$d_b \min.$	$D_b \max.$	$r_b \max.$		
7900 A5 DB DF DT	—	—	4 700	2 900	475	296	32 000	43 000	13.5	1.5	—	20.8	0.15
7900 C DB DF DT	—	—	4 900	3 050	500	310	38 000	53 000	10.3	1.7	—	20.8	0.15
7000 A DB DF DT	—	—	8 750	5 200	890	530	24 000	34 000	18.4	2.4	11.2	24.8	0.15
7000 C DB DF DT	—	—	8 650	5 000	880	510	36 000	50 000	12.8	3.2	—	24.8	0.15
7200 A DB DF DT	—	—	8 800	5 400	900	555	22 000	30 000	20.5	2.5	12.5	27.5	0.3
7200 B DB DF DT	—	—	8 100	5 000	825	510	16 000	22 000	25.8	7.8	12.5	27.5	0.3
7200 C DB DF DT	—	—	8 800	5 200	895	530	32 000	45 000	14.4	3.6	—	27.5	0.3
7300 A DB DF DT	—	—	15 100	8 600	1 540	880	16 000	22 000	24.0	2.0	12.5	32.5	0.3
7300 B DB DF DT	—	—	14 200	8 100	1 450	825	14 000	20 000	29.9	7.9	12.5	32.5	0.3
7901 A5 DB DF DT	—	—	5 200	3 550	530	360	30 000	43 000	14.4	2.4	—	22.8	0.15
7901 C DB DF DT	—	—	5 450	3 700	555	380	36 000	50 000	10.8	1.2	—	22.8	0.15
7001 A DB DF DT	—	—	9 400	5 950	955	610	22 000	30 000	19.5	3.5	13.2	26.8	0.15
7001 C DB DF DT	—	—	9 400	5 800	960	590	32 000	45 000	13.4	2.6	—	26.8	0.15
7201 A DB DF DT	—	—	13 000	8 050	1 330	820	20 000	28 000	22.7	2.7	14.5	29.5	0.3
7201 B DB DF DT	—	—	12 100	7 500	1 230	765	15 000	20 000	28.5	8.5	14.5	29.5	0.3
*7201 BEA	—	—	—	—	—	—	16 000	24 000	28.5	8.5	14.5	29.5	0.3
7201 C DB DF DT	—	—	12 800	7 700	1 310	785	30 000	40 000	15.9	4.1	—	29.5	0.3
7301 A DB DF DT	—	—	15 400	9 000	1 570	915	15 000	20 000	26.1	2.1	17	32	0.6
7301 B DB DF DT	—	—	14 400	8 400	1 460	855	13 000	18 000	32.6	8.6	17	32	0.6
*7301 BEA	—	—	—	—	—	—	15 000	22 000	32.6	8.6	17	32	0.6
7902 A5 DB DF DT	—	—	7 400	5 050	755	515	26 000	34 000	17.0	3.0	—	26.8	0.15
7902 C DB DF DT	—	—	7 750	5 300	790	540	30 000	43 000	12.8	1.2	—	26.8	0.15
7002 A DB DF DT	—	—	9 950	6 850	1 010	700	19 000	26 000	22.6	4.6	16.2	30.8	0.15
7002 C DB DF DT	—	—	10 100	6 750	1 030	690	28 000	38 000	15.3	2.7	—	30.8	0.15
7202 A DB DF DT	—	—	14 000	9 300	1 430	950	18 000	24 000	25.4	3.4	17.5	32.5	0.3
7202 B DB DF DT	—	—	12 900	8 600	1 310	875	13 000	18 000	32.0	10.0	17.5	32.5	0.3
*7202 BEA	—	—	—	—	—	—	14 000	20 000	32.0	10.0	17.5	32.5	0.3
7202 C DB DF DT	—	—	14 100	9 050	1 440	925	26 000	36 000	17.7	4.3	—	32.5	0.3
7302 A DB DF DT	—	—	21 800	14 200	2 220	1 440	13 000	17 000	29.5	3.5	20	37	0.6
7302 B DB DF DT	—	—	20 200	13 200	2 060	1 340	11 000	15 000	36.9	10.9	20	37	0.6
*7302 BEA	—	—	—	—	—	—	13 000	18 000	36.9	10.9	20	37	0.6

Note (3) For bearings marked — in the column for d_b , d_b and r_b for shafts are d_a (min) and r_a (max) respectively.
 Remarks The bearings denoted by an aster

SINGLE/MATCHED MOUNTINGS

Bore Diameter 17 – 25 mm

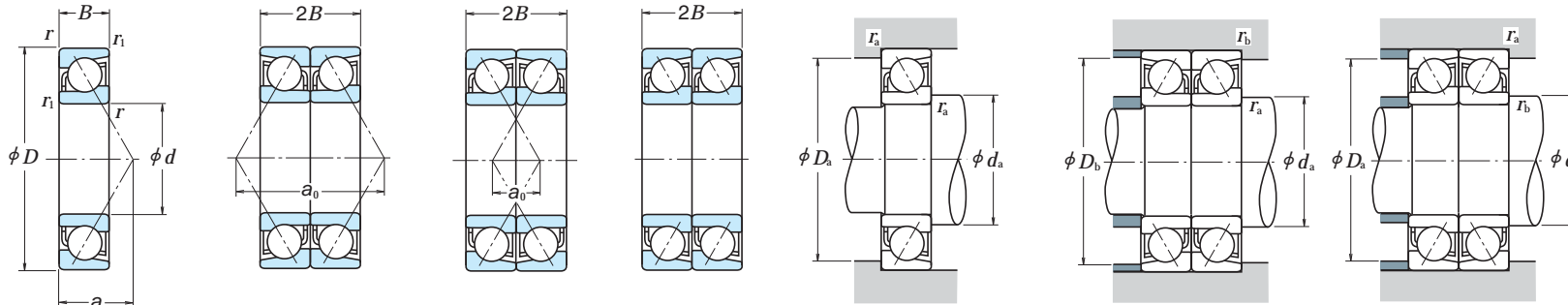

Single Back-to-Back DB Face-to-Face DF Tandem DT

Dynamic Equivalent Load $P = X F_r + Y F_a$

Contact Angle	$i L_0 F_a^*/C_{0r}$	e	Single, DT				DB or DF			
			$F_a/F_r \leq e$		$F_a/F_r > e$		$F_a/F_r \leq e$		$F_a/F_r > e$	
			X	Y	X	Y	X	Y	X	Y
15°	0.178	0.38	1	0	0.44	1.47	1	1.65	0.72	2.39
	0.357	0.40	1	0	0.44	1.40	1	1.57	0.72	2.28
	0.714	0.43	1	0	0.44	1.30	1	1.46	0.72	2.11
	1.07	0.46	1	0	0.44	1.23	1	1.38	0.72	2.00
	1.43	0.47	1	0	0.44	1.19	1	1.34	0.72	1.93
	2.14	0.50	1	0	0.44	1.12	1	1.26	0.72	1.82
	3.57	0.55	1	0	0.44	1.02	1	1.14	0.72	1.66
	5.35	0.56	1	0	0.44	1.00	1	1.12	0.72	1.63
25°	—	0.68	1	0	0.41	0.87	1	0.92	0.67	1.41
30°	—	0.80	1	0	0.39	0.76	1	0.78	0.63	1.24
40°	—	1.14	1	0	0.35	0.57	1	0.55	0.57	0.93

*For i , use 2 for DB, DF and 1 for DT

Static Equivalent Load $P_0 = X_0 F_r + Y_0 F_a$

Contact Angle	Single, DT		DB or DF		Single or DT mounting When $F_r > 0.5 F_r + Y_0 F_a$ use $P_0 = F_r$
	X_0	Y_0	X_0	Y_0	
15°	0.5	0.46	1	0.92	
25°	0.5	0.38	1	0.76	
30°	0.5	0.33	1	0.66	
40°	0.5	0.26	1	0.52	

Boundary Dimensions (mm)	Basic Load Ratings (Single) (N)				Factor f_0	Limiting Speeds (1) (min ⁻¹)		Eff. Load Centers (mm) a	Abutment and Fillet Dimensions (mm)			Mass (kg) approx.				
	d	D	B	$r_{1 \min.}$		C_r	C_{0r}		Grease	Oil	$d_a \min.$		$D_a \max.$	$r_a \max.$		
17	30	7	0.3	0.15	4 750	2 800	485	286	—	30 000	40 000	9.0	19.5	27.5	0.3	0.017
	30	7	0.3	0.15	5 000	2 940	510	299	14.8	34 000	48 000	6.6	19.5	27.5	0.3	0.017
	35	10	0.3	0.15	6 400	3 800	655	390	—	22 000	30 000	12.5	19.5	32.5	0.3	0.040
	35	10	0.3	0.15	6 600	3 800	675	390	14.5	32 000	43 000	8.5	19.5	32.5	0.3	0.044
	40	12	0.6	0.3	10 800	6 000	1 100	610	—	20 000	28 000	14.2	22	35	0.6	0.067
	40	12	0.6	0.3	9 950	5 500	1 010	565	—	14 000	19 000	18.0	22	35	0.6	0.068
	40	12	0.6	0.3	11 600	6 100	1 180	625	—	16 000	22 000	18.2	22	35	0.6	0.065
	40	12	0.6	0.3	10 900	5 850	1 110	595	13.3	28 000	38 000	9.8	22	35	0.6	0.075
	47	14	1	0.6	15 900	8 650	1 630	880	—	14 000	19 000	16.2	23	41	1	0.116
	47	14	1	0.6	14 800	8 000	1 510	820	—	13 000	17 000	20.4	23	41	1	0.118
	47	14	1	0.6	16 800	8 300	1 720	850	—	14 000	20 000	20.4	23	41	1	0.113
	20	37	9	0.3	0.15	6 600	4 050	675	410	—	24 000	32 000	11.1	22.5	34.5	0.3
37		9	0.3	0.15	6 950	4 250	710	430	14.9	28 000	38 000	8.3	22.5	34.5	0.3	0.036
42		12	0.6	0.3	10 800	6 600	1 110	670	—	18 000	24 000	14.9	25	37	0.6	0.068
42		12	0.6	0.3	11 100	6 550	1 130	665	14.0	26 000	36 000	10.1	25	37	0.6	0.076
47		14	1	0.6	14 500	8 300	1 480	845	—	17 000	22 000	16.7	26	41	1	0.106
47		14	1	0.6	13 300	7 650	1 360	780	—	12 000	16 000	21.1	26	41	1	0.109
47		14	1	0.6	15 600	8 150	1 590	830	—	13 000	19 000	21.1	26	41	1	0.103
47		14	1	0.6	14 600	8 050	1 480	825	13.3	24 000	34 000	11.5	26	41	1	0.118
52		15	1.1	0.6	18 700	10 400	1 910	1 060	—	13 000	17 000	17.9	27	45	1	0.146
52		15	1.1	0.6	17 300	9 650	1 770	985	—	11 000	15 000	22.6	27	45	1	0.15
52		15	1.1	0.6	19 800	10 500	2 020	1 070	—	13 000	18 000	22.6	27	45	1	0.149
25		42	9	0.3	0.15	7 450	5 150	760	525	—	20 000	28 000	12.3	27.5	39.5	0.3
	42	9	0.3	0.15	7 850	5 400	800	555	15.5	24 000	34 000	9.0	27.5	39.5	0.3	0.042
	47	12	0.6	0.3	11 300	7 400	1 150	750	—	16 000	22 000	16.4	30	42	0.6	0.079
	47	12	0.6	0.3	11 700	7 400	1 190	755	14.7	22 000	30 000	10.8	30	42	0.6	0.089
	52	15	1	0.6	16 200	10 300	1 650	1 050	—	15 000	20 000	18.6	31	46	1	0.13
	52	15	1	0.6	14 800	9 400	1 510	960	—	10 000	14 000	23.7	31	46	1	0.133
	52	15	1	0.6	17 600	10 200	1 790	1 040	—	12 000	17 000	23.7	31	46	1	0.127
	52	15	1	0.6	16 600	10 200	1 690	1 040	14.0	22 000	28 000	12.7	31	46	1	0.143
	62	17	1.1	0.6	26 400	15 800	2 690	1 610	—	10 000	14 000	21.1	32	55	1	0.235

Notes (1) For applications operating near the limiting speed, refer to Page B49.
(2) The suffixes A, A5, B, and C represent contact angles of 30°, 25°, 40°, and 15° respectively.

Bearing Numbers (°)	Basic Load Ratings (Matched) (N)				Limiting Speeds (1) (Matched) (min ⁻¹)		Load Center Spacings (mm) a_0		Abutment and Fillet Dimensions (mm)				
	Single	Duplex	C_r	C_{0r}	Grease	Oil	DB	DF	d_b (°) min.	D_b max.	r_b (°) max.		
7903 A5 DB DF DT	—	—	7 750	5 600	790	570	24 000	32 000	18.0	4.0	—	28.8	0.15
7903 C DB DF DT	—	—	8 150	5 850	830	600	28 000	38 000	13.3	0.7	—	28.8	0.15
7003 A DB DF DT	—	—	10 400	7 650	1 060	780	17 000	24 000	25.0	5.0	18.2	33.8	0.15
7003 C DB DF DT	—	—	10 700	7 600	1 100	775	26 000	34 000	17.0	3.0	—	33.8	0.15
7203 A DB DF DT	—	—	17 600	12 000	1 790	1 220	16 000	22 000	28.5	4.5	19.5	37.5	0.3
7203 B DB DF DT	—	—	16 100	11 000	1 650	1 130	11 000	15 000	35.9	11.9	19.5	37.5	0.3
*7203 BEA	—	—	—	—	—	—	13 000	18 000	36.3	12.3	19.5	37.5	0.3
7203 C DB DF DT	—	—	17 600	11 700	1 800	1 190	22 000	32 000	19.6	4.4	—	37.5	0.3
7303 A DB DF DT	—	—	25 900	17 300	2 640	1 760	11 000	15 000	32.5	4.5	22	42	0.6
7303 B DB DF DT	—	—	24 000	16 000	2 450	1 640	10 000	14 000	40.9	12.9	22	42	0.6
*7303 BEA	—	—	—	—	—	—	11 000	16 000	40.9	12.9	22	42	0.6
7904 A5 DB DF DT	—	—	10 700	8 100	1 090	825	19 000	26 000	22.3	4.3	—	35.8	0.15
7904 C DB DF DT	—	—	11 300	8 500	1 150	865	22 000	32 000	16.6	1.4	—	35.8	0.15
7004 A DB DF DT	—	—	17 600	13 200	1 800	1 340	15 000	20 000	29.9	5.9	22.5	39.5	0.3
7004 C DB DF DT	—	—	18 000	13 100	1 840	1 330	20 000	30 000	20.3	3.7	—	39.5	0.3
7204 A DB DF DT	—	—	23 500	16 600	2 400	1 690	13 000	19 000	33.3	5.3	25	42	0.6
7204 B DB DF DT	—	—	21 600	15 300	2 210	1 560	9 500	13 000	42.1	14.1	25	42	0.6
*7204 BEA	—	—	—	—	—	—	11 000	16 000	42.1	14.1	25	42	0.6
7204 C DB DF DT	—	—	23 600	16 100	2 410	1 650	19 000	26 000	23.0	5.0	—	42	0.6
7304 A DB DF DT	—	—	30 500	20 800	3 100	2 130	10 000	13 000	35.8	5.8	25	47	0.6
7304 B DB DF DT	—	—	28 200	19 300	2 870	1 970	9 000	12 000	45.2	15.2	25	47	0.6
*7304 BEA	—	—	—	—	—	—	10 000	14 000	45.2	15.2	25	47	0.6
7905 A5 DB DF DT	—	—	12 100	10 300	1 230	1 050	16 000	22 000	24.6	6.6	—	40.8	0.15
7905 C DB DF DT	—	—	12 700	10 800	1 300	1 110	19 000	26 000	18.0	0.0	—	40.8	0.15
7005 A DB DF DT	—	—	18 300	14 800	1 870	1 510	13 000	17 000	32.8	8.8	27.5	44.5	0.3
7005 C DB DF DT	—	—	19 000	14 800	1 940	1 510	18 000	26 000	21.6	2.4	—	44.5	0.3
7205 A DB DF DT	—	—	26 300	20 500	2 690	2 090	12 000	16 000	37.2	7.2	30	47	0.6
7205 B DB DF DT	—	—	24 000	18 800	2 450	1 920	8 500	11 000	47.3	17.3	30	47	0.6
*7205 BEA	—	—	—	—	—	—	9 500	14 000	47.3	17.3	30	47	0.6
7205 C DB DF DT	—	—	27 000	20 400	2 750	2 080	17 000	24 000	25.3	4.7	—</		

SINGLE/MATCHED MOUNTINGS

Bore Diameter 25 – 40 mm

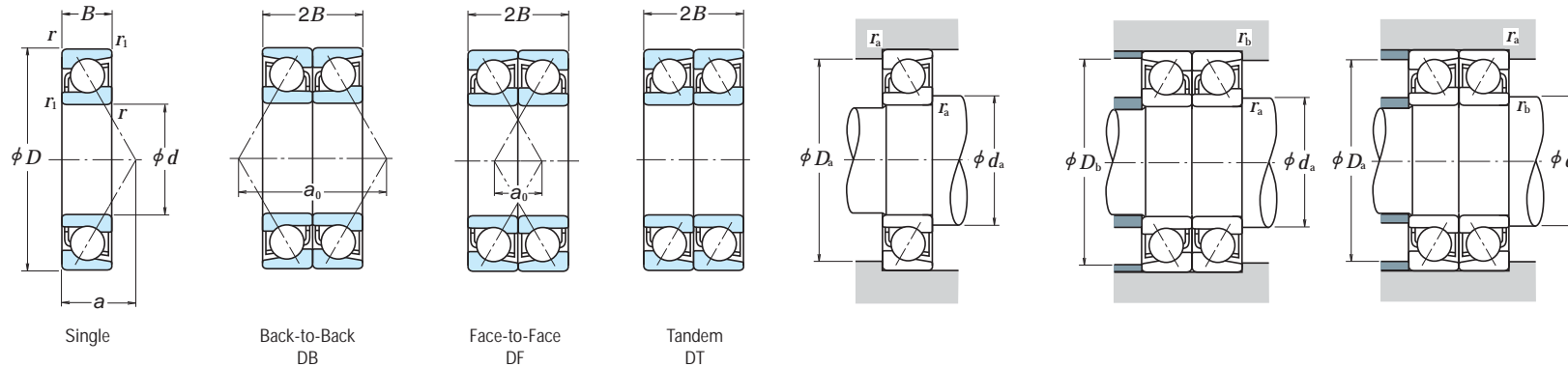

Boundary Dimensions (mm)				Basic Load Ratings (Single) (N)				Factor f_0	Limiting Speeds ⁽¹⁾ (min ⁻¹)		Eff. Load Centers (mm) a	Abutment and Fillet Dimensions (mm)			Mass (kg) approx.
d	D	B	$r_{1 \min.}$ / $r_{1 \max.}$	C_r	C_{0r}	C_r	C_{0r}		Grease	Oil		$d_a \min.$	$D_a \max.$	$r_a \max.$	
25	62	17	1.1 0.6	24 400	14 600	2 490	1 490	—	9 000	13 000	26.7	32	55	1	0.241
	62	17	1.1 0.6	27 200	14 900	2 770	1 520	—	10 000	15 000	26.8	32	55	1	0.229
30	47	9	0.3 0.15	7 850	5 950	800	605	—	18 000	24 000	13.5	32.5	44.5	0.3	0.049
	47	9	0.3 0.15	8 300	6 250	845	640	15.9	22 000	28 000	9.7	32.5	44.5	0.3	0.049
	55	13	1 0.6	14 500	10 100	1 480	1 030	—	13 000	18 000	18.8	36	49	1	0.116
	55	13	1 0.6	15 100	10 300	1 540	1 050	14.9	19 000	26 000	12.2	36	49	1	0.134
35	62	16	1 0.6	22 500	14 800	2 300	1 510	—	12 000	17 000	21.3	36	56	1	0.197
	62	16	1 0.6	20 500	13 500	2 090	1 380	—	8 500	12 000	27.3	36	56	1	0.202
	62	16	1 0.6	23 700	14 300	2 420	1 460	—	10 000	14 000	27.3	36	56	1	0.194
	62	16	1 0.6	23 000	14 700	2 350	1 500	13.9	18 000	24 000	14.2	36	56	1	0.222
	72	19	1.1 0.6	33 500	20 900	3 450	2 130	—	9 000	12 000	24.2	37	65	1	0.326
	72	19	1.1 0.6	31 000	19 300	3 150	1 960	—	8 000	11 000	30.9	37	65	1	0.354
	72	19	1.1 0.6	36 500	20 600	3 700	2 100	—	9 000	13 000	30.9	37	65	1	0.336
	72	19	1.1 0.6	31 000	19 300	3 150	1 960	—	8 000	11 000	30.9	37	65	1	0.354
	72	19	1.1 0.6	36 500	20 600	3 700	2 100	—	9 000	13 000	30.9	37	65	1	0.336
	72	19	1.1 0.6	31 000	19 300	3 150	1 960	—	8 000	11 000	30.9	37	65	1	0.354
	72	19	1.1 0.6	36 500	20 600	3 700	2 100	—	9 000	13 000	30.9	37	65	1	0.336
	40	55	10	0.6 0.3	11 400	8 700	1 170	885	—	15 000	20 000	15.5	40	50	0.6
55		10	0.6 0.3	12 100	9 150	1 230	930	15.7	18 000	24 000	11.0	40	50	0.6	0.074
62		14	1 0.6	18 300	13 400	1 870	1 370	—	12 000	16 000	21.0	41	56	1	0.153
62		14	1 0.6	19 100	13 700	1 950	1 390	15.0	17 000	22 000	13.5	41	56	1	0.173
72		17	1.1 0.6	29 700	20 100	3 050	2 050	—	10 000	14 000	23.9	42	65	1	0.287
72		17	1.1 0.6	27 100	18 400	2 760	1 870	—	7 500	10 000	30.9	42	65	1	0.294
72		17	1.1 0.6	32 500	19 600	3 300	1 990	—	8 500	12 000	30.9	42	65	1	0.271
72		17	1.1 0.6	30 500	19 900	3 100	2 030	13.9	15 000	20 000	15.7	42	65	1	0.32
80		21	1.5 1	40 000	26 300	4 050	2 680	—	8 000	10 000	27.1	44	71	1.5	0.464
80		21	1.5 1	36 500	24 200	3 750	2 460	—	7 100	9 500	34.6	44	71	1.5	0.474
80		21	1.5 1	40 500	24 400	4 100	2 490	—	8 000	11 000	34.6	44	71	1.5	0.451
40		62	12	0.6 0.3	14 300	11 200	1 460	1 140	—	14 000	18 000	17.9	45	57	0.6
	62	12	0.6 0.3	15 100	11 700	1 540	1 200	15.7	16 000	22 000	12.8	45	57	0.6	0.109
	68	15	1 0.6	19 500	15 400	1 990	1 570	—	10 000	14 000	23.1	46	62	1	0.19
	68	15	1 0.6	20 600	15 900	2 100	1 620	15.4	15 000	20 000	14.7	46	62	1	0.213
	80	18	1.1 0.6	35 500	25 100	3 600	2 560	—	9 500	13 000	26.3	47	73	1	0.375
	80	18	1.1 0.6	32 000	23 000	3 250	2 340	—	6 700	9 000	34.2	47	73	1	0.383

Notes ⁽¹⁾ For applications operating near the limiting speed, refer to Page B49.
⁽²⁾ The suffixes A, A5, B, and C represent contact angles of 30°, 25°, 40°, and 15° respectively.

Dynamic Equivalent Load $P = X F_r + Y F_a$

Contact Angle	$i f_0 F_a^* / C_{0r}$	e	Single, DT				DB or DF			
			$F_a/F_r \leq e$		$F_a/F_r > e$		$F_a/F_r \leq e$		$F_a/F_r > e$	
			X	Y	X	Y	X	Y	X	Y
15°	0.178	0.38	1	0	0.44	1.47	1	1.65	0.72	2.39
	0.357	0.40	1	0	0.44	1.40	1	1.57	0.72	2.28
	0.714	0.43	1	0	0.44	1.30	1	1.46	0.72	2.11
	1.07	0.46	1	0	0.44	1.23	1	1.38	0.72	2.00
	1.43	0.47	1	0	0.44	1.19	1	1.34	0.72	1.93
	2.14	0.50	1	0	0.44	1.12	1	1.26	0.72	1.82
	3.57	0.55	1	0	0.44	1.02	1	1.14	0.72	1.66
5.35	0.56	1	0	0.44	1.00	1	1.12	0.72	1.63	
25°	—	0.68	1	0	0.41	0.87	1	0.92	0.67	1.41
30°	—	0.80	1	0	0.39	0.76	1	0.78	0.63	1.24
40°	—	1.14	1	0	0.35	0.57	1	0.55	0.57	0.93

*For i , use 2 for DB, DF and 1 for DT

Static Equivalent Load $P_0 = X_0 F_r + Y_0 F_a$

Contact Angle	Single, DT		DB or DF		Single or DT mounting When $F_r > 0.5 F_r + Y_0 F_a$ use $P_0 = F_r$
	X_0	Y_0	X_0	Y_0	
15°	0.5	0.46	1	0.92	
25°	0.5	0.38	1	0.76	
30°	0.5	0.33	1	0.66	
40°	0.5	0.26	1	0.52	

Bearing Numbers (°)	Basic Load Ratings (Matched) (N)				Limiting Speeds ⁽¹⁾ (Matched) (min ⁻¹)		Load Center Spacings (mm) a_0		Abutment and Fillet Dimensions (mm)		
	Single	Duplex	C_r	C_{0r}	Grease	Oil	DB	DF	d_b (°) min.	$D_b \max.$	r_b (°) max.
7305 B DB DF DT			39 500	29 300	—	—	53.5	19.5	30	57	0.6
*7305 BEA			—	—	8 500	12 000	53.5	19.5	30	57	0.6
7906 A5 DB DF DT			12 800	11 900	14 000	19 000	27.0	9.0	—	45.8	0.15
7906 C DB DF DT			13 500	12 500	17 000	24 000	19.3	1.3	—	45.8	0.15
7006 A DB DF DT			23 600	20 200	11 000	15 000	37.5	11.5	35	50	0.6
7006 C DB DF DT			24 600	20 500	15 000	22 000	24.4	1.6	—	50	0.6
7206 A DB DF DT			36 500	29 500	10 000	13 000	42.6	10.6	35	57	0.6
7206 B DB DF DT			33 500	27 000	7 100	9 500	54.6	22.6	35	57	0.6
*7206 BEA			—	—	8 000	11 000	54.6	22.6	35	57	0.6
7206 C DB DF DT			37 500	29 300	14 000	20 000	28.3	3.7	—	57	0.6
7306 A DB DF DT			54 500	41 500	7 100	9 500	48.4	10.4	35	67	0.6
7306 B DB DF DT			50 500	38 500	6 300	8 500	61.8	23.8	35	67	0.6
*7306 BEA			—	—	7 100	10 000	61.8	23.8	35	67	0.6
7907 A5 DB DF DT			18 600	17 400	12 000	17 000	31.0	11.0	—	52.5	0.3
7907 C DB DF DT			19 600	18 300	14 000	20 000	22.1	2.1	—	52.5	0.3
7007 A DB DF DT			29 700	26 800	9 500	13 000	42.0	14.0	40	57	0.6
7007 C DB DF DT			31 000	27 300	13 000	19 000	27.0	1.0	—	57	0.6
7207 A DB DF DT			48 500	40 000	8 500	12 000	47.9	13.9	40	67	0.6
7207 B DB DF DT			44 000	36 500	6 000	8 000	61.9	27.9	40	67	0.6
*7207 BEA			—	—	6 700	9 500	61.9	27.9	40	67	0.6
7207 C DB DF DT			49 500	40 000	12 000	17 000	31.3	2.7	—	67	0.6
7307 A DB DF DT			65 000	52 500	6 300	8 500	54.2	12.2	41	74	1
7307 B DB DF DT			59 500	48 500	5 600	7 500	69.2	27.2	41	74	1
*7307 BEA			—	—	6 300	9 000	69.2	27.2	41	74	1
7908 A5 DB DF DT			23 300	22 300	11 000	15 000	35.8	11.8	—	59.5	0.3
7908 C DB DF DT			24 600	23 500	13 000	18 000	25.7	1.7	—	59.5	0.3
7008 A DB DF DT			31 500	31 000	8 500	11 000	46.2	16.2	45	63	0.6
7008 C DB DF DT			33 500	32 000	12 000	17 000	29.5	0.5	—	63	0.6
7208 A DB DF DT			57 500	50 500	52.6	16.6	45	75	0.6		
7208 B DB DF DT			52 000	46 000	68.3	32.3	45	75	0.6		

Note ⁽³⁾ For bearings marked — in the column for d_b , D_b and r_b for shafts are d_a (min.) and r_a (max.) respectively.
 Remarks The bearings denoted by an asterisk (*) are NSKHPS Angular contact ball bearings and the column of Duplex in Bearing Numbers indicates the universal matching.

SINGLE/MATCHED MOUNTINGS

Bore Diameter 40 – 55 mm

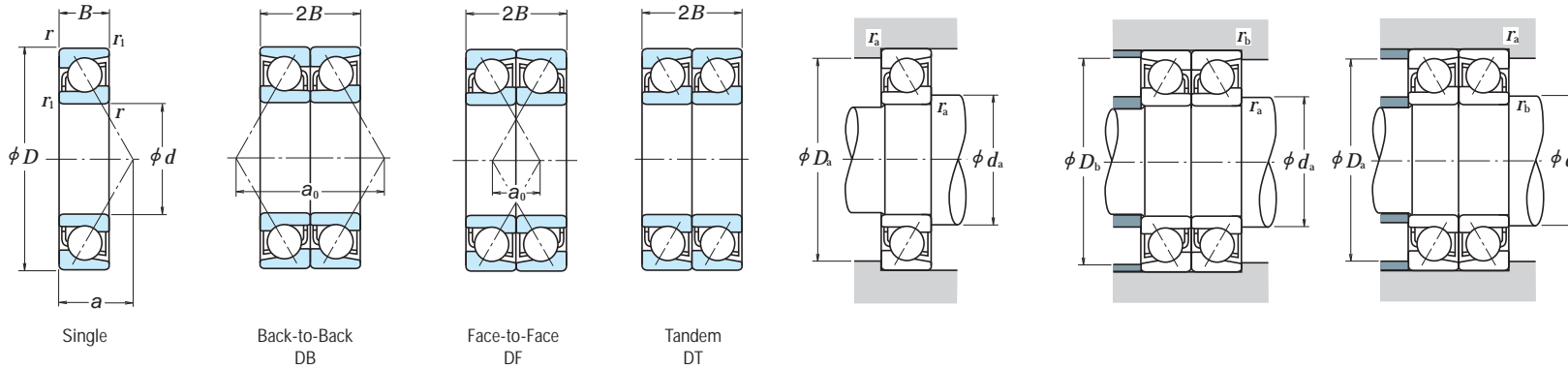

Dynamic Equivalent Load $P = X F_r + Y F_a$

Contact Angle	$i L_0 F_a^* / C_{0r}$	e	Single, DT				DB or DF			
			$F_a/F_r \leq e$		$F_a/F_r > e$		$F_a/F_r \leq e$		$F_a/F_r > e$	
			X	Y	X	Y	X	Y	X	Y
15°	0.178	0.38	1	0	0.44	1.47	1	1.65	0.72	2.39
	0.357	0.40	1	0	0.44	1.40	1	1.57	0.72	2.28
	0.714	0.43	1	0	0.44	1.30	1	1.46	0.72	2.11
	1.07	0.46	1	0	0.44	1.23	1	1.38	0.72	2.00
	1.43	0.47	1	0	0.44	1.19	1	1.34	0.72	1.93
	2.14	0.50	1	0	0.44	1.12	1	1.26	0.72	1.82
	3.57	0.55	1	0	0.44	1.02	1	1.14	0.72	1.66
	5.35	0.56	1	0	0.44	1.00	1	1.12	0.72	1.63
25°	—	0.68	1	0	0.41	0.87	1	0.92	0.67	1.41
30°	—	0.80	1	0	0.39	0.76	1	0.78	0.63	1.24
40°	—	1.14	1	0	0.35	0.57	1	0.55	0.57	0.93

*For i , use 2 for DB, DF and 1 for DT

Static Equivalent Load $P_0 = X_0 F_r + Y_0 F_a$

Contact Angle	Single, DT		DB or DF		Single or DT mounting When $F_r > 0.5 F_r + Y_0 F_a$ use $P_0 = F_r$
	X_0	Y_0	X_0	Y_0	
15°	0.5	0.46	1	0.92	
25°	0.5	0.38	1	0.76	
30°	0.5	0.33	1	0.66	
40°	0.5	0.26	1	0.52	

Boundary Dimensions (mm)				Basic Load Ratings (Single) (N)				Factor f_0	Limiting Speeds (1) (min ⁻¹)		Eff. Load Centers (mm) a	Abutment and Fillet Dimensions (mm)			Mass (kg) approx.	
d	D	B	$r_{1 \min.}$ $r_{1 \max.}$	C_r	C_{0r}	C_r	C_{0r}		Grease	Oil		$d_a \min.$	$D_a \max.$	$r_a \max.$		
40	80	18	1.1	0.6	38 500	24 500	3 900	2 500	—	7 500	11 000	34.2	47	73	1	0.357
	80	18	1.1	0.6	36 500	25 200	3 700	2 570	14.1	14 000	19 000	17.0	47	73	1	0.418
	90	23	1.5	1	49 000	33 000	5 000	3 350	—	7 100	9 000	30.3	49	81	1.5	0.633
	90	23	1.5	1	45 000	30 500	4 550	3 100	—	6 300	8 500	38.8	49	81	1.5	0.648
	90	23	1.5	1	53 000	33 000	5 400	3 350	—	7 100	10 000	38.8	49	81	1.5	0.619
	45	68	12	0.6	0.3	15 100	12 700	1 540	1 290	—	12 000	17 000	19.2	50	63	0.6
68		12	0.6	0.3	16 000	13 400	1 630	1 360	16.0	14 000	20 000	13.6	50	63	0.6	0.129
75		16	1	0.6	23 100	18 700	2 360	1 910	—	9 500	13 000	25.3	51	69	1	0.25
75		16	1	0.6	24 400	19 300	2 490	1 960	15.4	14 000	19 000	16.0	51	69	1	0.274
85		19	1.1	0.6	39 500	28 700	4 050	2 930	—	8 500	12 000	28.3	52	78	1	0.411
85		19	1.1	0.6	36 000	26 200	3 650	2 680	—	6 300	8 500	36.8	52	78	1	0.421
85	85	19	1.1	0.6	40 500	27 100	4 100	2 760	—	7 100	10 000	36.8	52	78	1	0.40
	85	19	1.1	0.6	41 000	28 800	4 150	2 940	14.2	12 000	17 000	18.2	52	78	1	0.468
	100	25	1.5	1	63 500	43 500	6 450	4 450	—	6 300	8 500	33.4	54	91	1.5	0.848
	100	25	1.5	1	58 500	40 000	5 950	4 100	—	5 600	7 500	42.9	54	91	1.5	0.869
	100	25	1.5	1	62 500	39 500	6 400	4 050	—	6 300	9 000	42.9	54	91	1.5	0.823
	50	72	12	0.6	0.3	15 900	14 200	1 630	1 450	—	11 000	15 000	20.2	55	67	0.6
72		12	0.6	0.3	16 900	15 000	1 720	1 530	16.2	13 000	18 000	14.2	55	67	0.6	0.13
80		16	1	0.6	24 500	21 100	2 500	2 150	—	8 500	12 000	26.8	56	74	1	0.263
80		16	1	0.6	26 000	21 900	2 650	2 230	15.7	12 000	17 000	16.7	56	74	1	0.293
90		20	1.1	0.6	41 500	31 500	4 200	3 200	—	8 000	11 000	30.2	57	83	1	0.466
90		20	1.1	0.6	37 500	28 600	3 800	2 920	—	5 600	8 000	39.4	57	83	1	0.477
90	90	20	1.1	0.6	42 000	29 700	4 300	3 050	—	6 300	9 500	39.4	57	83	1	0.453
	90	20	1.1	0.6	43 000	31 500	4 350	3 250	14.5	12 000	16 000	19.4	57	83	1	0.528
	110	27	2	1	74 000	52 000	7 550	5 300	—	5 600	7 500	36.6	60	100	2	1.1
	110	27	2	1	68 000	48 000	6 950	4 900	—	5 000	6 700	47.1	60	100	2	1.12
	110	27	2	1	78 000	50 500	7 950	5 150	—	5 600	8 000	47.1	60	100	2	1.07
	55	80	13	1	0.6	18 100	16 800	1 840	1 710	—	10 000	14 000	22.2	61	74	1
80		13	1	0.6	19 100	17 700	1 950	1 810	16.3	12 000	16 000	15.5	61	74	1	0.182
90		18	1.1	0.6	32 500	27 700	3 300	2 830	—	7 500	11 000	29.9	62	83	1	0.391

Notes (1) For applications operating near the limiting speed, refer to Page B49.
 (2) The suffixes A, A5, B, and C represent contact angles of 30°, 25°, 40°, and 15° respectively.

Bearing Numbers (°)		Basic Load Ratings (Matched) (N)				Limiting Speeds (1) (Matched) (min ⁻¹)		Load Center Spacings (mm) a_0		Abutment and Fillet Dimensions (mm)			
Single	Duplex	C_r	C_{0r}	C_r	C_{0r}	Grease	Oil	DB	DF	d_b (°) min.	D_b max.	r_b (°) max.	
*7208 BEA	DB	—	—	—	—	6 000	8 500	68.3	32.3	45	75	0.6	
	DF	—	—	—	—	11 000	15 000	34.1	1.9	—	75	0.6	
	DT	—	—	—	—	5 600	7 500	60.5	14.5	46	84	1	
	DB	—	—	—	—	7 300	10 000	77.5	31.5	46	84	1	
	DF	—	—	—	—	5 000	6 700	77.5	31.5	46	84	1	
	DT	—	—	—	—	5 600	8 000	77.5	31.5	46	84	1	
*7308 BEA	DB	—	—	—	—	9 500	13 000	38.4	14.4	—	65.5	0.3	
	DF	—	—	—	—	12 000	16 000	27.1	3.1	—	65.5	0.3	
	DT	—	—	—	—	7 500	10 000	50.6	18.6	50	70	0.6	
	DB	—	—	—	—	39 500	38 500	4 050	3 950	11 000	15 000	32.1	0.1
	DF	—	—	—	—	64 500	57 500	6 550	5 850	7 100	9 500	56.5	18.5
	DT	—	—	—	—	58 500	52 500	5 950	5 350	5 000	6 700	73.5	35.5
*7209 BEA	DB	—	—	—	—	5 600	8 000	73.5	35.5	50	80	0.6	
	DF	—	—	—	—	10 000	14 000	36.4	1.6	—	80	0.6	
	DT	—	—	—	—	5 000	6 700	66.9	16.9	51	94	1	
	DB	—	—	—	—	9 500	13 000	38.4	14.4	—	65.5	0.3	
	DF	—	—	—	—	12 000	16 000	27.1	3.1	—	65.5	0.3	
	DT	—	—	—	—	7 500	10 000	50.6	18.6	50	70	0.6	
*7309 BEA	DB	—	—	—	—	5 000	6 700	73.5	35.5	50	80	0.6	
	DF	—	—	—	—	7 100	9 500	56.5	18.5	50	80	0.6	
	DT	—	—	—	—	5 000	6 700	73.5	35.5	50	80	0.6	
	DB	—	—	—	—	24 600	25 400	2 510	2 590	9 500	13 000	38.4	14.4
	DF	—	—	—	—	26 000	26 800	2 660	2 730	12 000	16 000	27.1	3.1
	DT	—	—	—	—	37 500	37 500	3 850	3 800	7 500	10 000	50.6	18.6
*7009 A	DB	—	—	—	—	39 500	38 500	4 050	3 950	11 000	15 000	32.1	0.1
	DF	—	—	—	—	64 500	57 500	6 550	5 850	7 100	9 500	56.5	18.5
	DT	—	—	—	—	58 500	52 500	5 950	5 350	5 000	6 700	73.5	35.5
	DB	—	—	—	—	66 500	57 500	6 750	5 850	10 000	14 000	36.4	1.6
	DF	—	—	—	—	103 000	87 000	10 500	8 900	5 000	6 700	66.9	16.9
	DT	—	—	—	—	9 500	80 500	9 650	8 200	4 500	6 000	85.8	35.8
*7309 B	DB	—	—	—	—	5 000	6 700	73.5	35.5	50	80	0.6	
	DF	—	—	—	—	7 100	9 500	56.5	18.5	50	80	0.6	
	DT	—	—	—	—	5 000	6 700	73.5	35.5	50	80	0.6	
	DB	—	—	—	—	25 900	28 400	2 640	2 900	9 000	12 000	40.5	16.5
	DF	—	—	—	—	27 400	30 000	2 800	3 050	11 000	15 000	28.3	4.3
	DT	—	—	—	—	40 000	42 000	4 050	4 300	7 100	9 500	53.5	21.5
*7010 A	DB	—	—	—	—	42 000	44 000	4 300	4 450	10 000	14 000	33.4	

SINGLE/MATCHED MOUNTINGS

Bore Diameter 55 – 65 mm

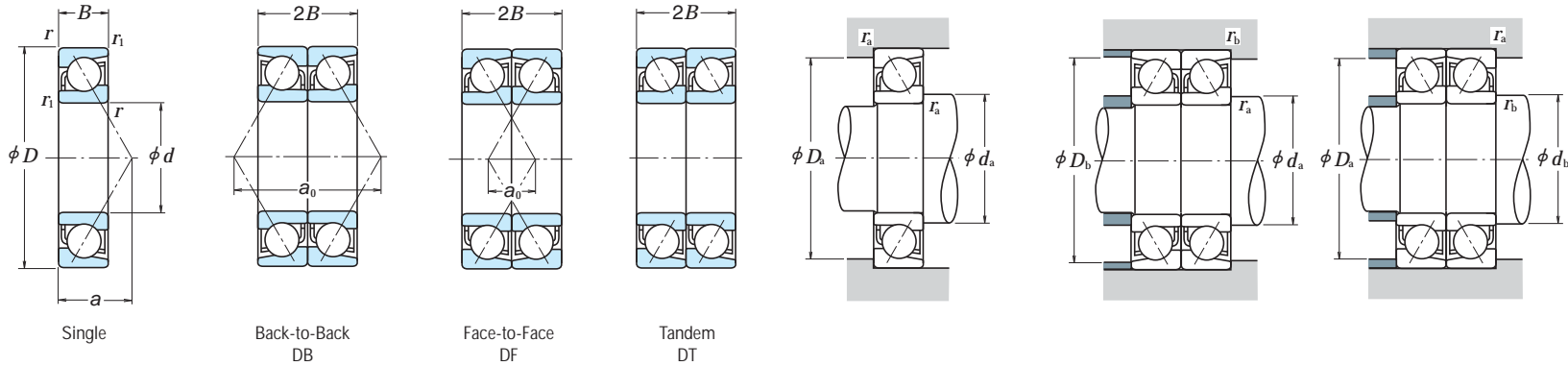

Dynamic Equivalent Load = $r + a$

Contact Angle	$\frac{a}{C_{or}}$	Single, DT				DB or DF				
		$\frac{a}{r} \leq 0.5$	$\frac{a}{r} > 0.5$	$\frac{a}{r} \leq 0.5$	$\frac{a}{r} > 0.5$	$\frac{a}{r} \leq 0.5$	$\frac{a}{r} > 0.5$	$\frac{a}{r} \leq 0.5$	$\frac{a}{r} > 0.5$	
15°	0.178	0.38	1	0	0.44	1.47	1	1.65	0.72	2.39
	0.357	0.40	1	0	0.44	1.40	1	1.57	0.72	2.28
	0.714	0.43	1	0	0.44	1.30	1	1.46	0.72	2.11
	1.07	0.46	1	0	0.44	1.23	1	1.38	0.72	2.00
	1.43	0.47	1	0	0.44	1.19	1	1.34	0.72	1.93
	2.14	0.50	1	0	0.44	1.12	1	1.26	0.72	1.82
	3.57	0.55	1	0	0.44	1.02	1	1.14	0.72	1.66
	5.35	0.56	1	0	0.44	1.00	1	1.12	0.72	1.63
25°	—	0.68	1	0	0.41	0.87	1	0.92	0.67	1.41
30°	—	0.80	1	0	0.39	0.76	1	0.78	0.63	1.24
40°	—	1.14	1	0	0.35	0.57	1	0.55	0.57	0.93

*For r , use 2 for DB, DF and 1 for DT

Static Equivalent Load $\theta = \theta_r + \theta_a$

Contact Angle	Single, DT		DB or DF	
	θ	θ	θ	θ
15°	0.5	0.46	1	0.92
25°	0.5	0.38	1	0.76
30°	0.5	0.33	1	0.66
40°	0.5	0.26	1	0.52

Single or DT mounting When $r > 0.5$ use $\theta = r$

Boundary Dimensions (mm)	Basic Load Ratings (Single) (N)				Factor θ	Limiting Speeds (1) (min ⁻¹)		Eff. Load Centers (mm) a	Abutment and Fillet Dimensions (mm)			Mass (kg) approx.					
	d	D	B	r min. r_1 min.		C_r	C_{0r}		Grease	Oil	d_a min.		D_a max.	r_a max.			
55	90	18	1.1	0.6	34 000	28 600	3 500	2 920	15.5	11 000	15 000	18.7	62	83	1	0.43	
	100	21	1.5	1	51 000	39 500	5 200	4 050	—	7 100	10 000	32.9	64	91	1.5	0.613	
	100	21	1.5	1	46 500	36 000	4 700	3 700	—	5 300	7 100	43.0	64	91	1.5	0.627	
	100	21	1.5	1	51 500	37 000	5 250	3 800	—	6 000	8 500	43.0	64	91	1.5	0.596	
	100	21	1.5	1	53 000	40 000	5 400	4 100	14.5	10 000	14 000	20.9	64	91	1.5	0.688	
	120	29	2	1	86 000	61 500	8 750	6 250	—	5 000	6 700	39.8	65	110	2	1.41	
	120	29	2	1	79 000	56 500	8 050	5 750	—	4 500	6 300	51.2	65	110	2	1.45	
	120	29	2	1	89 000	58 500	9 100	6 000	—	5 000	7 500	51.2	65	110	2	1.36	
	60	85	13	1	0.6	18 300	17 700	1 870	1 810	—	9 500	13 000	23.4	66	79	1	0.197
		85	13	1	0.6	19 400	18 700	1 980	1 910	16.5	11 000	15 000	16.2	66	79	1	0.194
		95	18	1.1	0.6	33 000	29 500	3 350	3 000	—	7 100	10 000	31.4	67	88	1	0.417
		95	18	1.1	0.6	35 000	30 500	3 600	3 150	15.7	10 000	14 000	19.4	67	88	1	0.46
110		22	1.5	1	62 000	48 500	6 300	4 950	—	6 700	9 000	35.5	69	101	1.5	0.798	
110		22	1.5	1	56 000	44 500	5 700	4 550	—	4 800	6 300	46.7	69	101	1.5	0.815	
110		22	1.5	1	61 500	45 000	6 300	4 600	—	5 300	7 500	46.7	69	101	1.5	0.791	
110		22	1.5	1	64 000	49 000	6 550	5 000	14.4	9 500	13 000	22.4	69	101	1.5	0.889	
130		31	2.1	1.1	98 000	71 500	10 000	7 250	—	4 800	6 300	42.9	72	118	2	1.74	
130		31	2.1	1.1	90 000	65 500	9 200	6 700	—	4 300	5 600	55.4	72	118	2	1.78	
130		31	2.1	1.1	102 000	68 500	10 500	7 000	—	4 800	6 700	55.4	72	118	2	1.7	
65		90	13	1	0.6	19 100	19 400	1 940	1 980	—	9 000	12 000	24.6	71	84	1	0.211
	90	13	1	0.6	20 200	20 500	2 060	2 090	16.7	10 000	14 000	16.9	71	84	1	0.208	
	100	18	1.1	0.6	35 000	33 000	3 550	3 350	—	6 700	9 500	32.8	72	93	1	0.455	
	100	18	1.1	0.6	37 000	34 500	3 800	3 500	15.9	10 000	13 000	20.0	72	93	1	0.493	
	120	23	1.5	1	70 500	58 000	7 150	5 900	—	6 000	8 500	38.2	74	111	1.5	1.03	
	120	23	1.5	1	63 500	52 500	6 500	5 350	—	4 300	6 000	50.3	74	111	1.5	1.05	
	120	23	1.5	1	70 000	53 500	7 150	5 450	—	4 800	7 100	50.3	74	111	1.5	1.01	
	120	23	1.5	1	73 000	58 500	7 450	6 000	14.6	9 000	12 000	23.9	74	111	1.5	1.14	
	140	33	2.1	1.1	111 000	82 000	11 300	8 350	—	4 300	6 000	46.1	77	128	2	2.12	
	140	33	2.1	1.1	102 000	75 500	10 400	7 700	—	3 800	5 300	59.5	77	128	2	2.17	
	140	33	2.1	1.1	114 000	77 000	11 600	7 850	—	4 300	6 300	59.5	77	128	2	2.09	

Notes (1) For applications operating near the limiting speed, refer to Page B49.
 (2) The suffixes A, A5, B, and C represent contact angles of 30°, 25°, 40°, and 15° respectively.

Bearing Numbers (°)	Basic Load Ratings (Matched) (N)				Limiting Speeds (1) (Matched) (min ⁻¹)		Load Center Spacings (mm) a_0		Abutment and Fillet Dimensions (mm)		
	Single	Duplex	C_r	C_{0r}	Grease	Oil	DB	DF	d_b (°) min.	D_b max.	r_b (°) max.
7011 C DB DF DT	—	—	55 500	57 500	9 000	12 000	37.4	1.4	—	85	0.6
7211 A DB DF DT	—	—	83 000	79 000	6 000	8 000	65.7	23.7	61	94	1
7211 B DB DF DT	—	—	75 000	72 000	4 000	5 600	86.0	44.0	61	94	1
*7211 BEA	—	—	—	—	4 500	6 700	86.0	44.0	61	94	1
7211 C DB DF DT	—	—	86 000	80 000	8 500	12 000	41.7	0.3	—	94	1
7311 A DB DF DT	—	—	139 000	123 000	4 000	5 600	79.5	21.5	61	114	1
7311 B DB DF DT	—	—	128 000	113 000	3 600	5 000	102.4	44.4	61	114	1
*7311 BEA	—	—	—	—	4 000	6 000	102.4	44.4	61	114	1
7912 A5 DB DF DT	—	—	29 800	35 500	7 500	10 000	46.8	20.8	—	80	0.6
7912 C DB DF DT	—	—	31 500	37 500	9 000	12 000	32.4	6.4	—	80	0.6
7012 A DB DF DT	—	—	53 500	59 000	6 000	8 000	62.7	26.7	65	90	0.6
7012 C DB DF DT	—	—	57 000	61 500	8 500	12 000	38.8	2.8	—	90	0.6
7212 A DB DF DT	—	—	100 000	97 500	5 300	7 100	71.1	27.1	66	104	1
7212 B DB DF DT	—	—	91 000	89 000	3 800	5 300	93.3	49.3	66	104	1
*7212 BEA	—	—	—	—	4 300	6 000	93.3	49.3	66	104	1
7212 C DB DF DT	—	—	104 000	98 500	7 500	11 000	44.8	0.8	—	104	1
7312 A DB DF DT	—	—	159 000	143 000	3 800	5 000	85.9	23.9	67	123	1
7312 B DB DF DT	—	—	146 000	131 000	3 400	4 500	110.7	48.7	67	123	1
*7312 BEA	—	—	—	—	3 800	5 600	110.7	48.7	67	123	1
7013 A5 DB DF DT	—	—	31 000	39 000	7 100	9 500	49.1	23.1	—	85	0.6
7913 C DB DF DT	—	—	33 000	41 000	8 500	12 000	33.8	7.8	—	85	0.6
7013 A DB DF DT	—	—	56 500	65 500	5 600	7 500	65.6	29.6	70	95	0.6
7013 C DB DF DT	—	—	60 500	68 500	8 000	11 000	40.1	4.1	—	95	0.6
7213 A DB DF DT	—	—	114 000	116 000	4 800	6 700	76.4	30.4	71	114	1
7213 B DB DF DT	—	—	103 000	105 000	3 400	4 800	100.6	54.6	71	114	1
*7213 BEA	—	—	—	—	3 800	5 600	100.6	54.6	71	114	1
7213 C DB DF DT	—	—	119 000	117 000	7 100	9 500	47.8	1.8	—	114	1
7313 A DB DF DT	—	—	180 000	164 000	3 600	4 800	92.2	26.2	72	133	1
7313 B DB DF DT	—	—	166 000	151 000	3 200	4 300	119.0	53.0	72	133	1
*7313 BEA	—	—	—	—	3 600	5 000	119.0	53.0	72	133	1

Note (3) For bearings marked — in the column for d_b , D_b and r_b for shafts are d_a (min.) and r_a (max.) respectively.
 Remarks The bearings denoted by an asterisk (*) are NSKHPS Angular contact ball bearings and the column of Duplex in Bearing Numbers indicates the universal matching.

SINGLE/MATCHED MOUNTINGS

Bore Diameter 70 – 80 mm

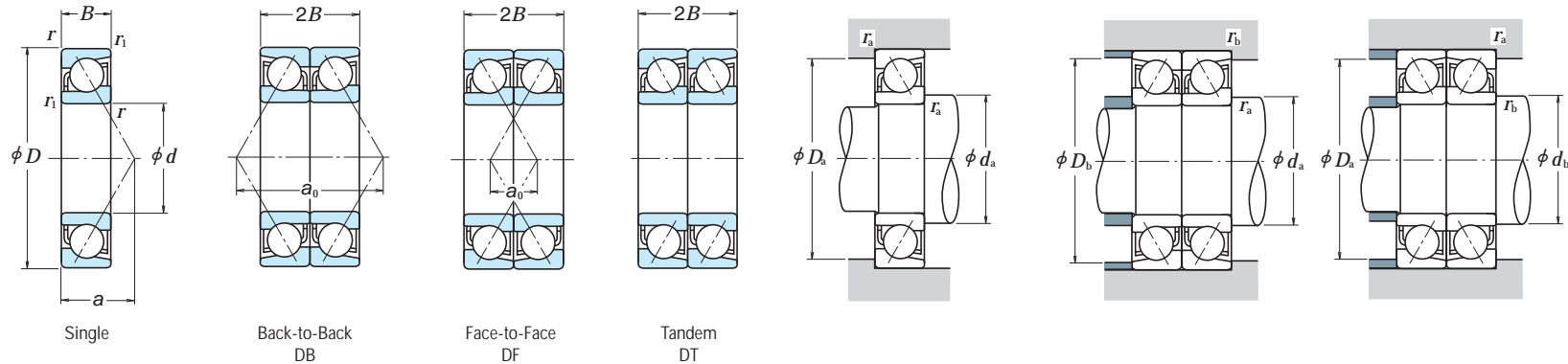

Dynamic Equivalent Load $P = X F_r + Y F_a$

Contact Angle	$i L_0 F_a^* / C_{or}$	e	Single, DT				DB or DF				
			$F_a/F_r \leq e$		$F_a/F_r > e$		$F_a/F_r \leq e$		$F_a/F_r > e$		
			X	Y	X	Y	X	Y	X	Y	
15°	0.178	0.38	1	0	0.44	1.47	1	1	1.65	0.72	2.39
	0.357	0.40	1	0	0.44	1.40	1	1	1.57	0.72	2.28
	0.714	0.43	1	0	0.44	1.30	1	1	1.46	0.72	2.11
	1.07	0.46	1	0	0.44	1.23	1	1	1.38	0.72	2.00
	1.43	0.47	1	0	0.44	1.19	1	1	1.34	0.72	1.93
	2.14	0.50	1	0	0.44	1.12	1	1	1.26	0.72	1.82
	3.57	0.55	1	0	0.44	1.02	1	1	1.14	0.72	1.66
	5.35	0.56	1	0	0.44	1.00	1	1	1.12	0.72	1.63
25°	—	0.68	1	0	0.41	0.87	1	1	0.92	0.67	1.41
30°	—	0.80	1	0	0.39	0.76	1	1	0.78	0.63	1.24
40°	—	1.14	1	0	0.35	0.57	1	1	0.55	0.57	0.93

*For i , use 2 for DB, DF and 1 for DT

Static Equivalent Load $P_0 = X_0 F_r + Y_0 F_a$

Contact Angle	Single, DT		DB or DF		Single or DT mounting When $F_r > 0.5 F_r + Y_0 F_a$ use $P_0 = F_r$
	X_0	Y_0	X_0	Y_0	
15°	0.5	0.46	1	0.92	
25°	0.5	0.38	1	0.76	
30°	0.5	0.33	1	0.66	
40°	0.5	0.26	1	0.52	

Boundary Dimensions (mm)	Basic Load Ratings (Single) (N)				Factor f_0	Limiting Speeds (1) (min ⁻¹)		Eff. Load Centers (mm) a	Abutment and Fillet Dimensions (mm)			Mass (kg) approx.					
	d	D	B	$r_{1 \text{ min.}}$		C_r	C_{0r}		Grease	Oil	$d_a \text{ min.}$		$D_a \text{ max.}$	$r_a \text{ max.}$			
70	100	16	1	0.6	26 500	26 300	2 710	2 680	—	8 000	11 000	27.8	76	94	1	0.341	
	100	16	1	0.6	28 100	27 800	2 870	2 830	16.4	9 500	13 000	19.4	76	94	1	0.338	
	110	20	1.1	0.6	44 000	41 500	4 500	4 200	—	6 300	8 500	36.0	77	103	1	0.625	
	110	20	1.1	0.6	47 000	43 000	4 800	4 400	15.7	9 000	12 000	22.1	77	103	1	0.698	
	125	24	1.5	1	76 500	63 500	7 800	6 500	—	5 600	8 000	40.1	79	116	1.5	1.11	
	125	24	1.5	1	69 000	58 000	7 050	5 900	—	4 000	5 600	52.9	79	116	1.5	1.14	
	125	24	1.5	1	75 500	58 500	7 700	6 000	—	4 500	6 700	52.9	79	116	1.5	1.08	
	125	24	1.5	1	79 500	64 500	8 100	6 600	14.6	8 500	11 000	25.1	79	116	1.5	1.24	
	150	35	2.1	1.1	125 000	93 500	12 700	9 500	—	4 000	5 300	49.3	82	138	2	2.6	
	150	35	2.1	1.1	114 000	86 000	11 700	8 750	—	3 600	5 000	63.6	82	138	2	2.65	
	150	35	2.1	1.1	124 000	87 500	12 600	8 900	—	4 000	6 000	63.7	82	138	2	2.53	
	75	105	16	1	0.6	26 900	27 700	2 750	2 820	—	7 500	10 000	29.0	81	99	1	0.355
105		16	1	0.6	28 600	29 300	2 910	2 980	16.6	9 000	12 000	20.1	81	99	1	0.357	
115		20	1.1	0.6	45 000	43 500	4 600	4 450	—	6 000	8 000	37.4	82	108	1	0.661	
115		20	1.1	0.6	48 000	45 500	4 900	4 650	15.9	8 500	12 000	22.7	82	108	1	0.748	
130		25	1.5	1	76 000	64 500	7 750	6 550	—	5 600	7 500	42.1	84	121	1.5	1.19	
130		25	1.5	1	68 500	58 500	7 000	5 950	—	3 800	5 300	55.5	84	121	1.5	1.22	
130		25	1.5	1	78 500	63 500	8 000	6 450	—	4 300	6 300	55.5	84	121	1.5	1.18	
130		25	1.5	1	83 000	70 000	8 450	7 100	14.8	8 000	11 000	26.2	84	121	1.5	1.36	
160		37	2.1	1.1	136 000	106 000	13 800	10 800	—	3 800	5 000	52.4	87	148	2	3.13	
160		37	2.1	1.1	125 000	97 500	12 700	9 900	—	3 400	4 800	67.8	87	148	2	3.19	
80		110	16	1	0.6	27 300	29 000	2 790	2 960	—	7 100	10 000	30.2	86	104	1	0.38
		110	16	1	0.6	29 000	30 500	2 960	3 150	16.7	8 500	12 000	20.7	86	104	1	0.376
	125	22	1.1	0.6	55 000	53 000	5 650	5 400	—	5 600	7 500	40.6	87	118	1	0.88	
	125	22	1.1	0.6	58 500	55 500	6 000	5 650	15.7	8 000	11 000	24.7	87	118	1	0.966	
	140	26	2	1	89 000	76 000	9 100	7 750	—	5 000	7 100	44.8	90	130	2	1.46	
	140	26	2	1	80 500	69 500	8 200	7 050	—	3 600	5 000	59.1	90	130	2	1.49	
	140	26	2	1	87 500	70 000	8 950	7 150	—	4 000	6 000	59.2	90	130	2	1.42	
	140	26	2	1	93 000	77 500	9 450	7 900	14.7	7 500	10 000	27.7	90	130	2	1.63	
	170	39	2.1	1.1	147 000	119 000	15 000	12 100	—	3 600	4 800	55.6	92	158	2	3.71	
	170	39	2.1	1.1	135 000	109 000	13 800	11 100	—	3 200	4 300	71.9	92	158	2	3.79	

Notes (1) For applications operating near the limiting speed, refer to Page B49.
 (2) The suffixes A, A5, B, and C represent contact angles of 30°, 25°, 40°, and 15° respectively.

Bearing Numbers (°)	Basic Load Ratings (Matched) (N)				Limiting Speeds (1) (Matched) (min ⁻¹)		Load Center Spacings (mm) a_0		Abutment and Fillet Dimensions (mm)					
	Single	Duplex	C_r	C_{0r}	Grease	Oil	DB	DF	d_b (°) min.	D_b max.	r_b (°) max.			
7914 A5 DB DF DT	DB	DF	DT	43 000	52 500	4 400	5 350	6 300	9 000	55.6	23.6	—	95	0.6
	DB	DF	DT	45 500	55 500	4 650	5 650	7 500	11 000	38.8	6.8	—	95	0.6
	DB	DF	DT	71 500	82 500	7 300	8 450	5 000	6 700	72.0	32.0	75	105	0.6
7014 A DB DF DT	DB	DF	DT	76 000	86 000	7 750	8 750	7 100	10 000	44.1	4.1	—	105	0.6
	DB	DF	DT	124 000	127 000	12 600	13 000	4 500	6 300	80.3	32.3	76	119	1
	DB	DF	DT	112 000	116 000	11 500	11 800	3 200	4 500	105.8	57.8	76	119	1
*7214 BEA	DB	DF	DT	—	—	—	—	3 600	5 300	105.8	57.8	76	119	1
	DB	DF	DT	129 000	129 000	13 200	13 200	6 700	9 000	50.1	2.1	—	119	1
	DB	DF	DT	203 000	187 000	20 700	19 100	3 200	4 300	98.5	28.5	77	143	1
7314 B DB DF DT	DB	DF	DT	186 000	172 000	19 000	17 500	2 800	4 000	127.3	57.3	77	143	1
	DB	DF	DT	—	—	—	—	3 200	4 800	127.3	57.3	77	143	1
	DB	DF	DT	—	—	—	—	—	—	—	—	—	—	—
7915 A5 DB DF DT	DB	DF	DT	44 000	55 500	4 450	5 650	6 000	8 500	58.0	26.0	—	100	0.6
	DB	DF	DT	46 500	58 500	4 750	5 950	7 100	10 000	40.1	8.1	—	100	0.6
	DB	DF	DT	73 000	87 500	7 450	8 900	4 800	6 700	74.8	34.8	80	110	0.6
7015 C DB DF DT	DB	DF	DT	78 000	91 500	7 950	9 300	6 700	9 500	45.4	5.4	—	110	0.6
	DB	DF	DT	123 000	129 000	12 600	13 100	4 300	6 000	84.2	34.2	81	124	1
	DB	DF	DT	112 000	117 000	11 400	11 900	3 200	4 300	111.0	61.0	81	124	1
*7215 BEA	DB	DF	DT	—	—	—	—	3 600	5 000	111.0	61.0	81	124	1
	DB	DF	DT	134 000	140 000	13 700	14 200	6 300	9 000	52.4	2.4	—	124	1
	DB	DF	DT	221 000	212 000	22 500	21 600	3 000	4 000	104.8	30.8	82	153	1
7315 B DB DF DT	DB	DF	DT	202 000	195 000	20 600	19 800	2 800	3 800	135.6	61.6	82	153	1
	DB	DF	DT	—	—	—	—	—	—	—	—	—	—	—
	DB	DF	DT	—	—	—	—	—	—	—	—	—	—	—
7916 A5 DB DF DT	DB	DF	DT	44 500	58 000	4 550	5 900	5 600	8 000	60.3	28.3	—	105	0.6
	DB	DF	DT	47 000	61 500	4 800	6 250	6 700	9 500	41.5	9.5	—	105	0.6
	DB	DF	DT	89 500	106 000	9 150	10 800	4 300	6 000	81.2	37.2	85	120	0.6
7016 C DB DF DT	DB	DF	DT	95 500	111 000	9 700	11 300	6 300	9 000	49.4	5.4	—	120	0.6
	DB	DF	DT	145 000	152 000	14 700	15 600	4 000	5 600	89.5	37.5	86	134	1
	DB	DF	DT	131 000	139 000	13 300	14 100	2 800	4 000	118.3	66.3	86	134	1

SINGLE/MATCHED MOUNTINGS

Bore Diameter 100 – 120 mm

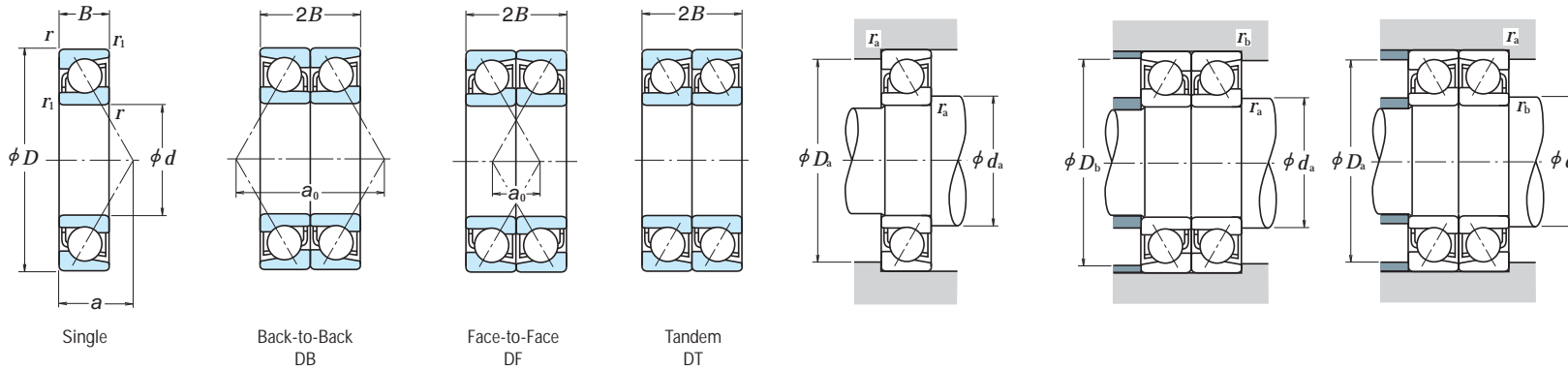

Boundary Dimensions (mm)	Basic Load Ratings (Single) (N)				Factor f_0	Limiting Speeds (1) (min ⁻¹)		Eff. Load Centers (mm) a	Abutment and Fillet Dimensions (mm)			Mass (kg) approx.				
	d	D	B	$r_{1 \min.}$		C_r	C_{0r}		Grease	Oil	$d_a \min.$		$D_a \max.$	$r_a \max.$		
100	150	24	1.5	1	75 000	77 000	7 700	7 900	16.0	6 300	9 000	28.7	109	141	1.5	1.46
	180	34	2.1	1.1	144 000	126 000	14 700	12 800	—	4 000	5 300	57.4	112	168	2	3.22
	180	34	2.1	1.1	130 000	114 000	13 300	11 700	—	2 800	3 800	75.7	112	168	2	3.28
180	34	2.1	1.1	1.1	149 000	127 000	15 200	12 900	14.5	5 600	8 000	35.7	112	168	2	3.65
	215	47	3	1.1	207 000	193 000	21 100	19 700	—	2 800	3 800	69.0	114	201	2.5	7.29
	215	47	3	1.1	190 000	178 000	19 400	18 100	—	2 400	3 400	89.6	114	201	2.5	7.43
105	145	20	1.1	0.6	48 000	54 000	4 900	5 500	—	5 600	7 500	39.2	112	138	1	0.82
	145	20	1.1	0.6	51 000	57 000	5 200	5 800	16.6	6 300	9 000	26.7	112	138	1	0.826
	160	26	2	1	80 000	81 500	8 150	8 350	—	4 300	5 600	51.2	115	150	2	1.84
160	26	2	1	1	88 000	89 500	9 000	9 100	15.9	6 000	8 500	30.7	115	150	2	1.82
	190	36	2.1	1.1	157 000	142 000	16 000	14 400	—	3 800	5 000	60.6	117	178	2	3.84
	190	36	2.1	1.1	142 000	129 000	14 500	13 100	—	2 600	3 600	79.9	117	178	2	3.92
190	36	2.1	1.1	1.1	162 000	143 000	16 600	14 600	14.5	5 300	7 500	37.7	117	178	2	4.33
	225	49	3	1.1	208 000	193 000	21 200	19 700	—	2 600	3 600	72.1	119	211	2.5	9.34
	225	49	3	1.1	191 000	177 000	19 400	18 100	—	2 400	3 200	93.7	119	211	2.5	9.43
110	150	20	1.1	0.6	49 000	56 000	5 000	5 750	—	5 300	7 100	40.3	117	143	1	0.877
	150	20	1.1	0.6	52 000	59 500	5 300	6 050	16.7	6 300	8 500	27.4	117	143	1	0.867
	170	28	2	1	96 500	95 500	9 850	9 700	—	4 000	5 300	54.4	120	160	2	2.28
170	28	2	1	1	106 000	104 000	10 800	10 600	15.6	5 600	8 000	32.7	120	160	2	2.26
	200	38	2.1	1.1	170 000	158 000	17 300	16 100	—	3 600	4 800	63.7	122	188	2	4.49
	200	38	2.1	1.1	154 000	144 000	15 700	14 700	—	2 600	3 400	84.0	122	188	2	4.58
200	38	2.1	1.1	1.1	176 000	160 000	17 900	16 300	14.5	5 000	7 100	39.8	122	188	2	5.1
	240	50	3	1.1	220 000	215 000	22 500	21 900	—	2 600	3 400	75.5	124	226	2.5	11.1
	240	50	3	1.1	201 000	197 000	20 500	20 100	—	2 200	3 000	98.4	124	226	2.5	11.2
120	165	22	1.1	0.6	67 500	77 000	6 900	7 850	—	4 800	6 300	44.2	127	158	1	1.15
	165	22	1.1	0.6	72 000	81 000	7 300	8 300	16.5	5 600	7 500	30.1	127	158	1	1.15
	180	28	2	1	102 000	107 000	10 400	10 900	—	3 600	5 000	57.3	130	170	2	2.45
215	40	2.1	1.1	1.1	183 000	177 000	18 600	18 100	—	3 200	4 500	68.3	132	203	2	6.22
	215	40	2.1	1.1	165 000	162 000	16 900	16 500	—	2 400	3 200	90.3	132	203	2	6.26
	260	55	3	1.1	246 000	252 000	25 100	25 700	—	2 200	3 000	82.3	134	246	2.5	14.5
260	55	3	1.1	225 000	231 000	23 000	23 600	—	2 000	2 800	107.2	134	246	2.5	14.4	

Notes (1) For applications operating near the limiting speed, refer to Page B49.
 (2) The suffixes A, A5, B, and C represent contact angles of 30°, 25°, 40°, and 15° respectively.

Dynamic Equivalent Load $P = X F_r + Y F_a$

Contact Angle	$i L_0 F_a^* / C_{0r}$	e	Single, DT				DB or DF			
			$F_a/F_r \leq e$		$F_a/F_r > e$		$F_a/F_r \leq e$		$F_a/F_r > e$	
			X	Y	X	Y	X	Y	X	Y
15°	0.178	0.38	1	0	0.44	1.47	1	1.65	0.72	2.39
	0.357	0.40	1	0	0.44	1.40	1	1.57	0.72	2.28
	0.714	0.43	1	0	0.44	1.30	1	1.46	0.72	2.11
	1.07	0.46	1	0	0.44	1.23	1	1.38	0.72	2.00
	1.43	0.47	1	0	0.44	1.19	1	1.34	0.72	1.93
	2.14	0.50	1	0	0.44	1.12	1	1.26	0.72	1.82
	3.57	0.55	1	0	0.44	1.02	1	1.14	0.72	1.66
	5.35	0.56	1	0	0.44	1.00	1	1.12	0.72	1.63
25°	—	0.68	1	0	0.41	0.87	1	0.92	0.67	1.41
30°	—	0.80	1	0	0.39	0.76	1	0.78	0.63	1.24
40°	—	1.14	1	0	0.35	0.57	1	0.55	0.57	0.93

*For i , use 2 for DB, DF and 1 for DT

Static Equivalent Load $P_0 = X_0 F_r + Y_0 F_a$

Contact Angle	Single, DT		DB or DF		Single or DT mounting When $F_r > 0.5 F_r + Y_0 F_a$ use $P_0 = F_r$
	X_0	Y_0	X_0	Y_0	
15°	0.5	0.46	1	0.92	—
25°	0.5	0.38	1	0.76	—
30°	0.5	0.33	1	0.66	—
40°	0.5	0.26	1	0.52	—

Bearing Numbers (°)	Basic Load Ratings (Matched) (N)				Limiting Speeds (1) (Matched) (min ⁻¹)		Load Center Spacings (mm) a_0		Abutment and Fillet Dimensions (mm)					
	Single	Duplex	C_r	C_{0r}	Grease	Oil	DB	DF	d_b (°) min.	D_b max.	r_b (°) max.			
7020 C	DB	DF	DT	122 000	154 000	12 500	15 800	5 300	7 100	57.5	9.5	—	144	1
7220 A	DB	DF	DT	233 000	251 000	23 800	25 600	3 200	4 300	114.8	46.8	107	173	1
7220 B	DB	DF	DT	212 000	229 000	21 600	23 300	2 200	3 000	151.5	83.5	107	173	1
7220 C	DB	DF	DT	242 000	254 000	24 700	25 900	4 500	6 300	71.5	3.5	—	173	1
7320 A	DB	DF	DT	335 000	385 000	34 500	39 500	2 200	3 000	137.9	43.9	107	208	1
7320 B	DB	DF	DT	310 000	355 000	31 500	36 000	2 000	2 800	179.2	85.2	107	208	1
7921 A5	DB	DF	DT	78 500	108 000	8 000	11 000	4 300	6 000	78.3	38.3	—	140	0.6
7921 C	DB	DF	DT	83 000	114 000	8 450	11 600	5 300	7 100	53.5	13.5	—	140	0.6
7021 A	DB	DF	DT	130 000	163 000	13 300	16 700	3 400	4 500	102.5	50.5	—	154	1
7021 C	DB	DF	DT	143 000	179 000	14 600	18 200	4 800	6 700	61.5	9.5	—	154	1
7221 A	DB	DF	DT	254 000	283 000	25 900	28 900	3 000	4 000	121.2	49.2	112	183	1
7221 B	DB	DF	DT	231 000	258 000	23 500	26 300	2 200	3 000	159.8	87.8	112	183	1
7221 C	DB	DF	DT	264 000	286 000	26 900	29 100	4 300	6 000	75.5	3.5	—	183	1
7321 A	DB	DF	DT	335 000	385 000	34 500	39 500	2 200	2 800	144.3	46.3	—	218	1
7321 B	DB	DF	DT	310 000	355 000	31 500	36 000	1 900	2 600	187.4	89.4	—	218	1
7922 A5	DB	DF	DT	79 500	112 000	8 100	11 500	4 300	5 600	80.6	40.6	—	145	0.6
7922 C	DB	DF	DT	84 500	119 000	8 600	12 100	5 000	6 700	54.8	14.8	—	145	0.6
7022 A	DB	DF	DT	157 000	191 000	16 000	19 400	3 200	4 300	108.8	52.8	—	164	1
7022 C	DB	DF	DT	172 000	208 000	17 600	21 200	4 500	6 300	65.5	9.5	—	164	1
7222 A	DB	DF	DT	276 000	315 000	28 100	32 500	2 800	4 000	127.5	51.5	117	193	1
7222 B	DB	DF	DT	250 000	289 000	25 500	29 400	2 000	2 800	168.1	92.1	117	193	1
7222 C	DB	DF	DT	286 000	320 000	29 200	33 500	4 000	5 600	79.5	3.5	—	193	1
7322 A	DB	DF	DT	360 000	430 000	36 500	44 000	2 000	2 600	151.0	51.0	—	233	1
7322 B	DB	DF	DT	325 000	395 000	33 500	40 000	1 800	2 400	196.8	96.8	—	233	1
7924 A5	DB	DF	DT	110 000	15									

SINGLE/MATCHED MOUNTINGS

Bore Diameter 130 – 170 mm

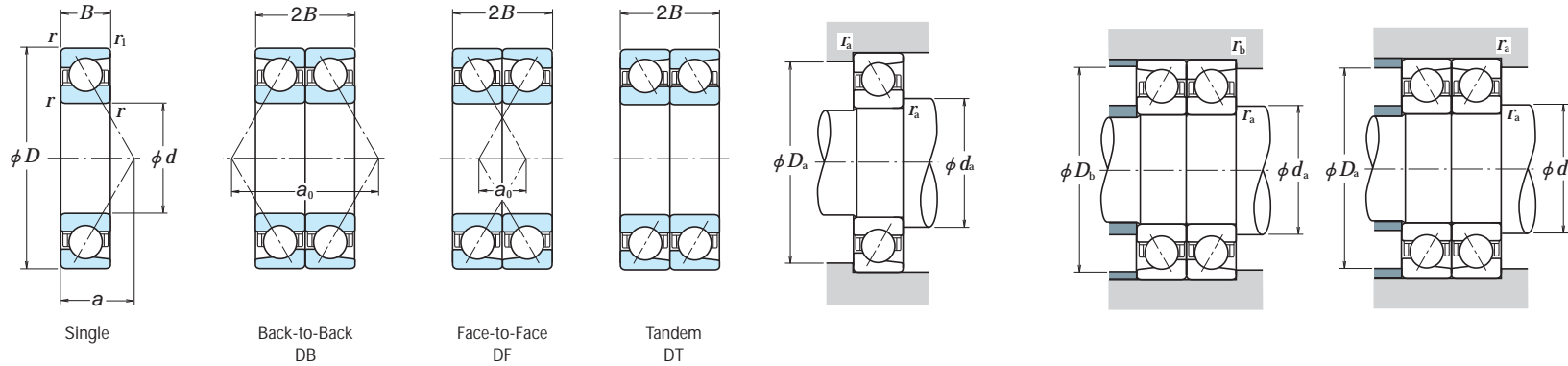

Boundary Dimensions (mm)	Basic Load Ratings (Single) (N)				Factor f_0	Limiting Speeds (1) (min ⁻¹)		Eff. Load Centers (mm) a	Abutment and Fillet Dimensions (mm)			Mass (kg) approx.		
	d	D	B	$r_{1 \min.}$		C_r	C_{0r}		Grease	Oil	$d_a \min.$		$D_a \max.$	$r_a \max.$
130	180	24	1.5	1	74 000	86 000	—	4 300	6 000	48.1	139	171	1.5	1.54
	180	24	1.5	1	78 500	91 000	16.5	5 000	7 100	32.8	139	171	1.5	1.5
	200	33	2	1	117 000	125 000	—	3 400	4 500	64.1	140	190	2	3.68
	230	40	3	1.1	189 000	193 000	—	2 400	3 200	72.0	144	216	2.5	7.06
	230	40	3	1.1	171 000	175 000	—	2 200	3 000	95.5	144	216	2.5	7.1
	280	58	4	1.5	273 000	293 000	—	2 200	2 800	88.2	148	262	3	17.5
140	190	24	1.5	1	75 000	90 000	—	4 000	5 600	50.5	149	181	1.5	1.63
	190	24	1.5	1	79 500	95 500	16.7	4 800	6 700	34.1	149	181	1.5	1.63
	210	33	2	1	120 000	133 000	—	3 200	4 300	67.0	150	200	2	3.9
	250	42	3	1.1	218 000	234 000	—	2 200	3 000	77.3	154	236	2.5	8.92
	250	42	3	1.1	197 000	213 000	—	2 000	2 800	102.8	154	236	2.5	8.94
	300	62	4	1.5	300 000	335 000	—	2 000	2 600	94.5	158	282	3	21.4
150	210	28	2	1	96 500	115 000	—	3 800	5 000	56.0	160	200	2	2.97
	210	28	2	1	102 000	122 000	16.6	4 300	6 000	38.1	160	200	2	2.96
	225	35	2.1	1.1	137 000	154 000	—	2 400	3 000	71.6	162	213	2	4.75
	270	45	3	1.1	248 000	280 000	—	2 000	2 800	83.1	164	256	2.5	11.2
	270	45	3	1.1	225 000	254 000	—	1 800	2 600	110.6	164	256	2.5	11.2
	320	65	4	1.5	315 000	370 000	—	1 800	2 400	100.3	168	302	3	26
160	220	28	2	1	106 000	133 000	16.7	3 800	5 000	39.4	170	210	2	3.1
	240	38	2.1	1.1	155 000	176 000	—	2 200	2 800	76.7	172	228	2	5.77
	290	48	3	1.1	263 000	305 000	—	1 900	2 600	89.0	174	276	2.5	14.1
	290	48	3	1.1	238 000	279 000	—	1 700	2 400	118.4	174	276	2.5	14.2
	340	68	4	1.5	345 000	420 000	—	1 700	2 200	106.2	178	322	3	30.7
	340	68	4	1.5	315 000	385 000	—	1 500	2 000	138.9	178	322	3	30.8
170	230	28	2	1	113 000	148 000	16.8	3 600	4 800	40.8	180	220	2	3.36
	260	42	2.1	1.1	186 000	214 000	—	2 000	2 600	83.1	182	248	2	7.9
	310	52	4	1.5	295 000	360 000	—	1 800	2 400	95.3	188	292	3	17.3
	310	52	4	1.5	266 000	325 000	—	1 600	2 200	126.7	188	292	3	17.6
	360	72	4	1.5	390 000	485 000	—	1 600	2 200	112.5	188	342	3	35.8
	360	72	4	1.5	355 000	445 000	—	1 400	2 000	147.2	188	342	3	35.6

Notes (1) For applications operating near the limiting speed, refer to Page B49.
 (2) The suffixes A, A5, B, and C represent contact angles of 30°, 25°, 40°, and 15° respectively.

Dynamic Equivalent Load $P = X F_r + Y F_a$

Contact Angle	$i L_0 F_a^*$ C_{or}	e	Single, DT				DB or DF			
			$F_a/F_r \leq e$		$F_a/F_r > e$		$F_a/F_r \leq e$		$F_a/F_r > e$	
			X	Y	X	Y	X	Y	X	Y
15°	0.178	0.38	1	0	0.44	1.47	1	1.65	0.72	2.39
	0.357	0.40	1	0	0.44	1.40	1	1.57	0.72	2.28
	0.714	0.43	1	0	0.44	1.30	1	1.46	0.72	2.11
	1.07	0.46	1	0	0.44	1.23	1	1.38	0.72	2.00
	1.43	0.47	1	0	0.44	1.19	1	1.34	0.72	1.93
	2.14	0.50	1	0	0.44	1.12	1	1.26	0.72	1.82
	3.57	0.55	1	0	0.44	1.02	1	1.14	0.72	1.66
	5.35	0.56	1	0	0.44	1.00	1	1.12	0.72	1.63
25°	—	0.68	1	0	0.41	0.87	1	0.92	0.67	1.41
30°	—	0.80	1	0	0.39	0.76	1	0.78	0.63	1.24
40°	—	1.14	1	0	0.35	0.57	1	0.55	0.57	0.93

*For i , use 2 for DB, DF and 1 for DT

Static Equivalent Load $P_0 = X_0 F_r + Y_0 F_a$

Contact Angle	Single, DT		DB or DF		Single or DT mounting When $F_r > 0.5 F_r + Y_0 F_a$ use $P_0 = F_r$
	X_0	Y_0	X_0	Y_0	
15°	0.5	0.46	1	0.92	—
25°	0.5	0.38	1	0.76	—
30°	0.5	0.33	1	0.66	—
40°	0.5	0.26	1	0.52	—

Bearing Numbers (°)	Basic Load Ratings (Matched) (N)				Limiting Speeds (1) (Matched) (min ⁻¹)		Load Center Spacings (mm) a_0		Abutment and Fillet Dimensions (mm)					
	Single	Duplex	C_r	C_{0r}	Grease	Oil	DB	DF	d_b (°) min.	D_b max.	r_b (°) max.			
7926 A5	DB	DF	DT	120 000	172 000	12 300	17 500	3 400	4 800	96.3	48.3	—	174	1
	DB	DF	DT	128 000	182 000	13 000	18 500	4 000	5 600	65.5	17.5	—	174	1
	DB	DF	DT	191 000	251 000	19 400	25 600	2 600	3 600	128.3	62.3	—	194	1
7226 A	DB	DF	DT	310 000	385 000	31 500	39 500	1 900	2 600	143.9	63.9	—	223	1
	DB	DF	DT	278 000	350 000	28 300	35 500	1 700	2 400	191.0	111.0	—	223	1
	DB	DF	DT	445 000	585 000	45 500	59 500	1 700	2 200	176.3	60.3	—	271	1.5
7326 B	DB	DF	DT	405 000	535 000	41 500	54 500	1 500	2 000	230.0	114.0	—	271	1.5
	DB	DF	DT	122 000	180 000	12 400	18 400	3 200	4 500	100.9	52.9	—	184	1
	DB	DF	DT	129 000	191 000	13 200	19 400	3 800	5 300	68.2	20.2	—	184	1
7028 A	DB	DF	DT	194 000	265 000	19 800	27 000	2 600	3 400	134.0	68.0	—	204	1
	DB	DF	DT	355 000	470 000	36 000	48 000	1 800	2 400	154.6	70.6	—	243	1
	DB	DF	DT	320 000	425 000	32 500	43 500	1 600	2 200	205.6	121.6	—	243	1
7328 B	DB	DF	DT	490 000	670 000	50 000	68 500	1 600	2 000	189.0	65.0	—	291	1.5
	DB	DF	DT	445 000	615 000	45 500	63 000	1 400	1 900	246.6	122.6	—	291	1.5
	DB	DF	DT	157 000	231 000	16 000	23 500	3 000	4 000	112.0	56.0	—	204	1
7930 A5	DB	DF	DT	166 000	244 000	16 900	24 900	3 600	4 800	76.2	20.2	—	204	1
	DB	DF	DT	222 000	305 000	22 700	31 500	1 900	2 400	143.3	73.3	—	218	1
	DB	DF	DT	405 000	560 000	41 000	57 000	1 600	2 200	166.3	76.3	—	263	1
7230 B	DB	DF	DT	365 000	510 000	37 000	52 000	1 500	2 000	221.2	131.2	—	263	1
	DB	DF	DT	515 000	745 000	52 500	75 500	1 500	1 900	200.7	70.7	—	311	1.5
	DB	DF	DT	470 000	680 000	48 000	69 500	1 300	1 800	262.2	132.2	—	311	1.5
7932 C	DB	DF	DT	173 000	265 000	17 600	27 000	3 000	4 000	78.9	22.9	—	214	1
	DB	DF	DT	252 000	355 000	25 700	36 000	1 700	2 400	153.5	77.5	—	233	1
	DB	DF	DT	425 000	615 000	43 500	62 500	1 500	2 000	177.9	81.9	—	283	1
7232 B	DB	DF	DT	385 000	555 000	39 500	57 000	1 400	1 900	236.8	140.8	—	283	1
	DB	DF	DT	565 000	845 000	57 500	86 000	1 400	1 800	212.3	76.3	—	331	1.5
	DB	DF	DT	515 000	770 000	52 500	78 500	1 200	1 700	277.8	141.8	—	331	1.5
7934 C	DB	DF	DT	183 000	297 000	18 700	30 000	2 800	3 800	81.6	25.6	—	224	1
	DB	DF	DT	300 000	430 000	31 000	43 500	1 600	2 200	166.1	82.1	—	253	1
	DB	DF	DT	480 000	715 000	49 000	73 000	1 400	1 900	190.6	86.6	—	301	1.5
7234 B	DB	DF	DT	435 000	650 000	44 000	66 500	1 300	1 700	253.4	149.4	—	301	1.5
	DB	DF	DT	630 000	970 000	64 500	99 000	1 300	1 700	225.0	81.0	—	351	1.5
	DB	DF	DT	575 000	890 000	59 000	90 500	1 100	1 600	294.3	150.3	—	351	1.5

Note (3) For bearings marked — in the column for d_b , D_b and r_b for shafts are d_a (min.) and r_a (max.) respectively.

SINGLE/MATCHED MOUNTINGS

Bore Diameter 180 – 200 mm

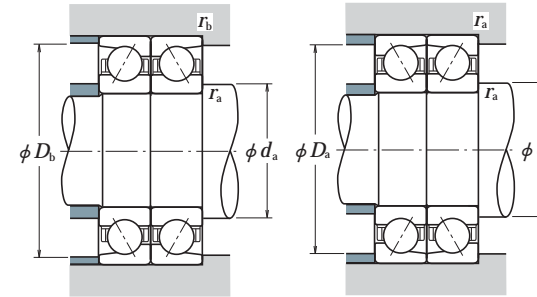
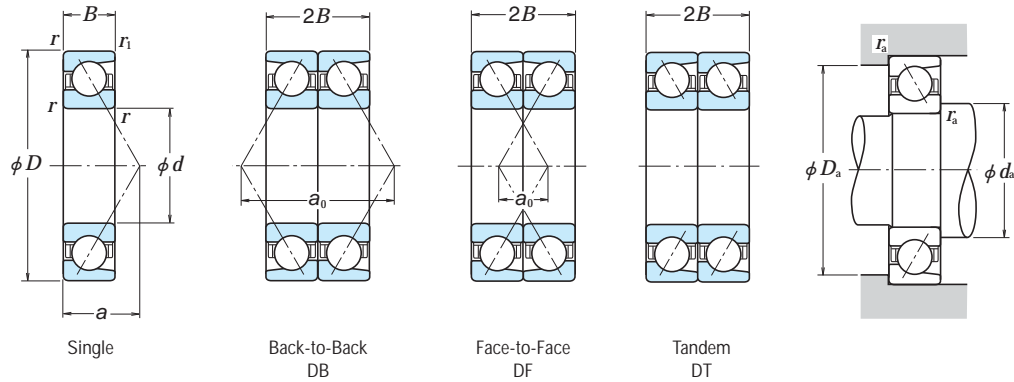

Boundary Dimensions (mm)	Basic Load Ratings (Single) (N)				Factor f_0	Limiting Speeds (1) (min ⁻¹)		Eff. Load Centers (mm) \bar{a}	Abutment and Fillet Dimensions (mm)			Mass (kg) approx.				
	d	D	B	$r_{1 \min.}$		C_r	C_{0r}		Grease	Oil	$d_a \min.$		$D_a \max.$	$r_a \max.$		
180	250	33	2	1	145 000	184 000	14 800	18 800	16.6	3 200	4 500	45.3	190	240	2	4.9
	280	46	2.1	1.1	207 000	252 000	21 100	25 700	—	1 900	2 400	89.4	192	268	2	10.5
	320	52	4	1.5	305 000	385 000	31 000	39 000	—	1 700	2 200	98.2	198	302	3	18.1
190	260	33	2	1	147 000	192 000	15 000	19 600	16.7	3 000	4 300	46.6	200	250	2	4.98
	290	46	2.1	1.1	224 000	280 000	22 800	28 600	—	1 800	2 400	92.3	202	278	2	11.3
	340	55	4	1.5	315 000	410 000	32 000	42 000	—	1 600	2 200	104.0	208	322	3	22.4
200	280	38	2.1	1.1	189 000	244 000	19 300	24 900	16.5	2 800	4 000	51.2	212	268	2	6.85
	310	51	2.1	1.1	240 000	310 000	24 500	31 500	—	1 700	2 200	99.1	212	298	2	13.7
	360	58	4	1.5	335 000	450 000	34 500	46 000	—	1 500	2 000	109.8	218	342	3	26.5
200	360	58	4	1.5	305 000	410 000	31 000	41 500	—	1 300	1 800	146.5	218	342	3	26.6
	420	80	5	2	475 000	660 000	48 500	67 000	—	1 300	1 800	129.5	222	398	4	54.4
	420	80	5	2	430 000	600 000	44 000	61 500	—	1 200	1 600	170.1	222	398	4	55.3

Notes (1) For applications operating near the limiting speed, refer to Page B49.
 (2) The suffixes A, A5, B, and C represent contact angles of 30°, 25°, 40°, and 15° respectively.

Dynamic Equivalent Load $P = X F_r + Y F_a$

Contact Angle	$i f_0 F_a^*$ C_{0r}	e	Single, DT				DB or DF			
			$F_a/F_r \leq e$		$F_a/F_r > e$		$F_a/F_r \leq e$		$F_a/F_r > e$	
			X	Y	X	Y	X	Y	X	Y
15°	0.178	0.38	1	0	0.44	1.47	1	1.65	0.72	2.39
	0.357	0.40	1	0	0.44	1.40	1	1.57	0.72	2.28
	0.714	0.43	1	0	0.44	1.30	1	1.46	0.72	2.11
	1.07	0.46	1	0	0.44	1.23	1	1.38	0.72	2.00
	1.43	0.47	1	0	0.44	1.19	1	1.34	0.72	1.93
	2.14	0.50	1	0	0.44	1.12	1	1.26	0.72	1.82
	3.57	0.55	1	0	0.44	1.02	1	1.14	0.72	1.66
5.35	0.56	1	0	0.44	1.00	1	1.12	0.72	1.63	
25°	—	0.68	1	0	0.41	0.87	1	0.92	0.67	1.41
30°	—	0.80	1	0	0.39	0.76	1	0.78	0.63	1.24
40°	—	1.14	1	0	0.35	0.57	1	0.55	0.57	0.93

*For i , use 2 for DB, DF and 1 for DT

Static Equivalent Load $P_0 = X_0 F_r + Y_0 F_a$

Contact Angle	Single, DT		DB or DF		Single or DT mounting When $F_r > 0.5 F_r + Y_0 F_a$ use $P_0 = F_r$
	X_0	Y_0	X_0	Y_0	
15°	0.5	0.46	1	0.92	
25°	0.5	0.38	1	0.76	
30°	0.5	0.33	1	0.66	
40°	0.5	0.26	1	0.52	

Bearing Numbers (2)	Basic Load Ratings (Matched) (N)				Limiting Speeds (1) (Matched) (min ⁻¹)		Load Center Spacings (mm) a_0		Abutment and Fillet Dimensions (mm)			
	Single	Duplex	C_r	C_{0r}	Grease	Oil	DB	DF	d_b (3) min.	D_b max.	r_b (3) max.	
7936 C	DB	DF	DT	236 000	370 000	2 600	3 600	90.6	24.6	—	244	1
7036 A	DB	DF	DT	335 000	505 000	1 500	2 000	178.8	86.8	—	273	1
7236 A	DB	DF	DT	495 000	770 000	1 400	1 800	196.3	92.3	—	311	1.5
7236 B	DB	DF	DT	450 000	700 000	1 200	1 700	261.8	157.8	—	311	1.5
7336 A	DB	DF	DT	665 000	1 070 000	1 200	1 600	236.6	86.6	—	371	1.5
7336 B	DB	DF	DT	605 000	975 000	1 100	1 500	309.9	159.9	—	371	1.5
7938 C	DB	DF	DT	239 000	385 000	2 400	3 400	93.3	27.3	—	254	1
7038 A	DB	DF	DT	365 000	560 000	1 400	1 900	184.6	92.6	—	283	1
7238 A	DB	DF	DT	510 000	825 000	1 300	1 700	208.0	98.0	—	331	1.5
7238 B	DB	DF	DT	460 000	750 000	1 100	1 600	277.3	167.3	—	331	1.5
7338 A	DB	DF	DT	730 000	1 200 000	1 100	1 500	248.3	92.3	—	390	2
7338 B	DB	DF	DT	670 000	1 100 000	1 000	1 400	325.5	169.5	—	390	2
7940 C	DB	DF	DT	305 000	490 000	2 200	3 200	102.3	26.3	—	273	1
7040 A	DB	DF	DT	390 000	620 000	1 300	1 800	198.2	96.2	—	303	1
7240 A	DB	DF	DT	550 000	900 000	1 200	1 600	219.6	103.6	—	351	1.5
7240 B	DB	DF	DT	495 000	815 000	1 100	1 500	292.9	176.9	—	351	1.5
7340 A	DB	DF	DT	770 000	1 320 000	1 100	1 400	259.0	99.0	—	410	2
7340 B	DB	DF	DT	700 000	1 200 000	950	1 300	340.1	180.1	—	410	2

Note (3) For bearings marked — in the column for d_b , D_b and r_b for shafts are d_a (min.) and r_a (max.) respectively.

Bore Diameter 10 – 85 mm

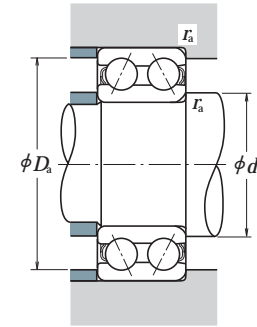
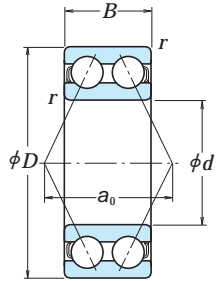

Dynamic Equivalent Load

$$P = XF_r + YF_a$$

$F_a/F_r \leq e$		$F_a/F_r > e$		e
X	Y	X	Y	
1	0.92	0.67	1.41	0.68

Static Equivalent Load

$$P_0 = F_r + 0.76 F_a$$

Boundary Dimensions (mm)				Basic Load Ratings				Limiting Speeds		Bearing Numbers
d	D	B	r min.	(N)	(kgf)	(min ⁻¹)		Grease	Oil	
				C_r	C_{0r}	C_r	C_{0r}			
10	30	14.3	0.6	7 150	3 900	730	400	17 000	22 000	5200
12	32	15.9	0.6	10 500	5 800	1 070	590	15 000	20 000	5201
15	35	15.9	0.6	11 700	7 050	1 190	715	13 000	17 000	5202
	42	19	1	17 600	10 200	1 800	1 040	11 000	15 000	5302
17	40	17.5	0.6	14 600	9 050	1 490	920	11 000	15 000	5203
	47	22.2	1	21 000	12 600	2 140	1 280	10 000	13 000	5303
20	47	20.6	1	19 600	12 400	2 000	1 270	10 000	13 000	5204
	52	22.2	1.1	24 600	15 000	2 510	1 530	9 000	12 000	5304
25	52	20.6	1	21 300	14 700	2 170	1 500	8 500	11 000	5205
	62	25.4	1.1	32 500	20 700	3 350	2 110	7 500	10 000	5305
30	62	23.8	1	29 600	21 100	3 000	2 150	7 100	9 500	5206
	72	30.2	1.1	40 500	28 100	4 150	2 870	6 300	8 500	5306
35	72	27	1.1	39 000	28 700	4 000	2 920	6 300	8 000	5207
	80	34.9	1.5	51 000	36 000	5 200	3 700	5 600	7 500	5307
40	80	30.2	1.1	44 000	33 500	4 500	3 400	5 600	7 100	5208
	90	36.5	1.5	56 500	41 000	5 800	4 200	5 300	6 700	5308
45	85	30.2	1.1	49 500	38 000	5 050	3 900	5 000	6 700	5209
	100	39.7	1.5	68 500	51 000	7 000	5 200	4 500	6 000	5309
50	90	30.2	1.1	53 000	43 500	5 400	4 400	4 800	6 000	5210
	110	44.4	2	81 500	61 500	8 300	6 250	4 300	5 600	5310
55	100	33.3	1.5	56 000	49 000	5 700	5 000	4 300	5 600	5211
	120	49.2	2	95 000	73 000	9 700	7 450	3 800	5 000	5311
60	110	36.5	1.5	69 000	62 000	7 050	6 300	3 800	5 000	5212
	130	54	2.1	125 000	98 500	12 800	10 000	3 400	4 500	5312
65	120	38.1	1.5	76 500	69 000	7 800	7 050	3 600	4 500	5213
	140	58.7	2.1	142 000	113 000	14 500	11 500	3 200	4 300	5313
70	125	39.7	1.5	94 000	82 000	9 600	8 400	3 400	4 500	5214
	150	63.5	2.1	159 000	128 000	16 200	13 100	3 000	3 800	5314
75	130	41.3	1.5	93 500	83 000	9 550	8 500	3 200	4 300	5215
80	140	44.4	2	99 000	93 000	10 100	9 500	3 000	3 800	5216
85	150	49.2	2	116 000	110 000	11 800	11 200	2 800	3 600	5217

Load Center Spacings (mm) a_0	Abutment and Fillet Dimensions (mm)			Mass (kg) approx.
	d_a min.	D_a max.	r_a max.	
14.5	15	25	0.6	0.050
16.7	17	27	0.6	0.060
18.3	20	30	0.6	0.070
22.0	21	36	1	0.11
20.8	22	35	0.6	0.090
25.0	23	41	1	0.14
24.3	26	41	1	0.12
26.7	27	45	1	0.23
26.8	31	46	1	0.19
31.8	32	55	1	0.34
31.6	36	56	1	0.29
36.5	37	65	1	0.51
36.6	42	65	1	0.43
41.6	44	71	1.5	0.79
41.5	47	73	1	0.57
45.5	49	81	1.5	1.05
43.4	52	78	1	0.62
50.6	54	91	1.5	1.4
45.9	57	83	1	0.67
55.6	60	100	2	1.95
50.1	64	91	1.5	0.96
60.6	65	110	2	2.3
56.5	69	101	1.5	1.35
69.2	72	118	2	3.15
59.7	74	111	1.5	1.65
72.8	77	128	2	3.85
63.8	79	116	1.5	1.8
78.3	82	138	2	4.9
66.1	84	121	1.5	1.9
69.6	90	130	2	2.5
75.3	95	140	2	3.4

Bore Diameter 30 – 95 mm

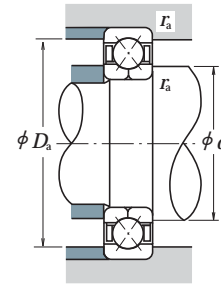
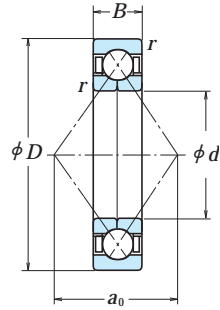

Dynamic Equivalent Load
 $P_a = F_a$

Static Equivalent Load
 $P_{0a} = F_a$

Boundary Dimensions (mm)				Basic Load Ratings				Limiting Speeds	
d	D	B	r min.	(N)		(kgf)		Grease	Oil
				C_a	C_{0a}	C_a	C_{0a}		
30	62	16	1	31 000	45 000	3 150	4 600	8 500	12 000
	72	19	1.1	46 000	63 000	4 700	6 450	8 000	11 000
35	72	17	1.1	41 000	61 500	4 200	6 250	7 500	10 000
	80	21	1.5	55 000	80 000	5 600	8 150	7 100	9 500
40	80	18	1.1	49 000	77 500	5 000	7 900	6 700	9 000
	90	23	1.5	67 000	100 000	6 850	10 200	6 300	8 500
45	85	19	1.1	55 000	88 500	5 600	9 000	6 300	8 500
	100	25	1.5	87 500	133 000	8 900	13 500	5 600	7 500
50	90	20	1.1	57 000	97 000	5 850	9 900	5 600	8 000
	110	27	2	102 000	159 000	10 400	16 200	5 000	6 700
55	100	21	1.5	71 000	122 000	7 200	12 500	5 300	7 100
	120	29	2	118 000	187 000	12 000	19 100	4 500	6 300
60	110	22	1.5	85 500	150 000	8 750	15 300	4 800	6 300
	130	31	2.1	135 000	217 000	13 800	22 200	4 300	5 600
65	120	23	1.5	97 500	179 000	9 950	18 300	4 300	6 000
	140	33	2.1	153 000	250 000	15 600	25 500	3 800	5 300
70	125	24	1.5	106 000	197 000	10 800	20 100	4 000	5 600
	150	35	2.1	172 000	285 000	17 500	29 100	3 600	5 000
75	130	25	1.5	110 000	212 000	11 200	21 700	3 800	5 300
	160	37	2.1	187 000	320 000	19 100	33 000	3 400	4 800
80	125	22	1.1	77 000	167 000	7 850	17 000	3 800	5 300
	140	26	2	124 000	236 000	12 600	24 100	3 600	5 000
	170	39	2.1	202 000	360 000	20 600	37 000	3 200	4 300
85	130	22	1.1	79 000	176 000	8 050	18 000	3 800	5 000
	150	28	2	143 000	276 000	14 600	28 200	3 400	4 800
	180	41	3	218 000	405 000	22 300	41 000	3 000	4 000
90	140	24	1.5	94 000	208 000	9 600	21 200	3 400	4 800
	160	30	2	164 000	320 000	16 700	32 500	3 200	4 300
	190	43	3	235 000	450 000	23 900	45 500	2 800	3 800
95	145	24	1.5	96 500	220 000	9 800	22 500	3 400	4 500
	170	32	2.1	177 000	340 000	18 000	35 000	3 000	4 000
	200	45	3	251 000	495 000	25 600	50 500	2 600	3 600

Bearing Numbers	Load Center Spacings (mm) a_0	Abutment and Fillet Dimensions (mm)			Mass (kg) approx.
		d_a min.	D_a max.	r_a max.	
QJ 206	32.2	36	56	1	0.24
QJ 306	35.7	37	65	1	0.42
QJ 207	37.5	42	65	1	0.35
QJ 307	40.3	44	71	1.5	0.57
QJ 208	42.0	47	73	1	0.45
QJ 308	45.5	49	81	1.5	0.78
QJ 209	45.5	52	78	1	0.52
QJ 309	50.8	54	91	1.5	1.05
QJ 210	49.0	57	83	1	0.59
QJ 310	56.0	60	100	2	1.35
QJ 211	54.3	64	91	1.5	0.77
QJ 311	61.3	65	110	2	1.75
QJ 212	59.5	69	101	1.5	0.98
QJ 312	66.5	72	118	2	2.15
QJ 213	64.8	74	111	1.5	1.2
QJ 313	71.8	77	128	2	2.7
QJ 214	68.3	79	116	1.5	1.3
QJ 314	77.0	82	138	2	3.18
QJ 215	71.8	84	121	1.5	1.5
QJ 315	82.3	87	148	2	3.9
QJ 1016	71.8	87	118	1	1.05
QJ 216	77.0	90	130	2	1.85
QJ 316	87.5	92	158	2	4.6
QJ 1017	75.3	92	123	1	1.1
QJ 217	82.3	95	140	2	2.2
QJ 317	92.8	99	166	2.5	5.34
QJ 1018	80.5	99	131	1.5	1.45
QJ 218	87.5	100	150	2	2.75
QJ 318	98.0	104	176	2.5	6.4
QJ 1019	84.0	104	136	1.5	1.5
QJ 219	92.8	107	158	2	3.35
QJ 319	103.3	109	186	2.5	7.4

Remarks When using four-point contact ball bearings, please contact NSK.

Bore Diameter 100 – 200 mm

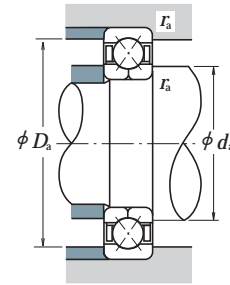
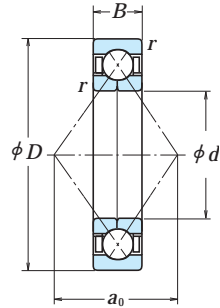

Dynamic Equivalent Load
 $P_a = F_a$

Static Equivalent Load
 $P_{0a} = F_a$

Boundary Dimensions (mm)				Basic Load Ratings (N)				Limiting Speeds (min ⁻¹)	
<i>d</i>	<i>D</i>	<i>B</i>	<i>r</i> _{min.}	<i>C_a</i>	<i>C_{0a}</i>	(kgf)		Grease	Oil
						<i>C_a</i>	<i>C_{0a}</i>		
100	150	24	1.5	98 000	232 000	10 000	23 700	3 200	4 300
	180	34	2.1	199 000	390 000	20 300	39 500	2 800	3 800
	215	47	3	300 000	640 000	31 000	65 500	2 400	3 400
105	160	26	2	115 000	269 000	11 800	27 400	3 000	4 000
	190	36	2.1	217 000	435 000	22 100	44 500	2 600	3 600
	225	49	3	305 000	640 000	31 000	65 500	2 400	3 200
110	170	28	2	139 000	315 000	14 200	27 400	2 800	3 800
	200	38	2.1	235 000	490 000	24 000	50 000	2 600	3 400
	240	50	3	320 000	710 000	32 500	72 500	2 200	3 000
120	180	28	2	147 000	350 000	15 000	36 000	2 600	3 600
	215	40	2.1	265 000	585 000	27 000	60 000	2 400	3 200
	260	55	3	360 000	835 000	36 500	85 500	2 000	2 800
130	200	33	2	169 000	415 000	17 300	42 000	2 400	3 200
	230	40	3	274 000	635 000	28 000	65 000	2 200	3 000
	280	58	4	400 000	970 000	40 500	99 000	1 900	2 600
140	210	33	2	172 000	435 000	17 600	44 500	2 200	3 000
	250	42	3	239 000	710 000	29 900	72 500	2 000	2 800
	300	62	4	440 000	1 110 000	44 500	114 000	1 700	2 400
150	225	35	2.1	197 000	505 000	20 100	51 500	2 000	2 800
	270	45	3	315 000	785 000	32 000	80 000	1 800	2 600
	320	65	4	460 000	1 230 000	47 000	125 000	1 600	2 200
160	240	38	2.1	224 000	580 000	22 800	59 000	1 900	2 600
	290	48	3	380 000	1 010 000	39 000	103 000	1 700	2 400
	340	68	4	505 000	1 400 000	51 500	143 000	1 500	2 000
170	260	42	2.1	268 000	705 000	27 300	72 000	1 800	2 400
	310	52	4	425 000	1 180 000	43 500	121 000	1 600	2 200
	360	72	4	565 000	1 610 000	57 500	164 000	1 400	2 000
180	280	46	2.1	299 000	830 000	30 500	84 500	1 700	2 200
	320	52	4	440 000	1 270 000	45 000	130 000	1 500	2 000
	380	75	4	595 000	1 770 000	60 500	180 000	1 300	1 800
190	290	46	2.1	325 000	925 000	33 000	94 000	1 600	2 200
	340	55	4	440 000	1 290 000	44 500	131 000	1 400	2 000
	400	78	5	655 000	1 980 000	67 000	202 000	1 300	1 700
200	310	51	2.1	345 000	1 020 000	35 500	104 000	1 500	2 000
	360	58	4	490 000	1 480 000	49 500	151 000	1 300	1 800
	420	80	5	690 000	2 180 000	70 500	222 000	1 200	1 600

Bearing Numbers	Load Center Spacings (mm) <i>a</i> ₀	Abutment and Fillet Dimensions (mm)			Mass (kg) approx.
		<i>d</i> _a min.	<i>D</i> _a max.	<i>r</i> _a max.	
QJ 1020	87.5	109	141	1.5	1.6
QJ 220	98.0	112	168	2	4.0
QJ 320	110.3	114	201	2.5	9.3
QJ 1021	92.8	115	150	2	2.0
QJ 221	103.3	117	178	2	4.7
QJ 321	115.5	119	211	2.5	10.5
QJ 1022	98.0	120	160	2	2.5
QJ 222	108.5	122	188	2	5.6
QJ 322	122.5	124	226	2.5	12.5
QJ 1024	105.0	130	170	2	2.65
QJ 224	117.3	132	203	2	6.9
QJ 324	133.0	134	246	2.5	15.4
QJ 1026	115.5	140	190	2	4.0
QJ 226	126.0	144	216	2.5	7.7
QJ 326	143.5	148	262	3	19
QJ 1028	122.5	150	200	2	4.3
QJ 228	136.5	154	236	2.5	9.8
QJ 328	154.0	158	282	3	24
QJ 1030	131.3	162	213	2	5.2
QJ 230	147.0	164	256	2.5	12
QJ 330	164.5	168	302	3	29
QJ 1032	140.0	172	228	2	6.4
QJ 232	157.5	174	276	2.5	15
QJ 332	175.1	178	322	3	31
QJ 1034	150.5	182	248	2	8.6
QJ 234	168.0	188	292	3	19.5
QJ 334	185.6	188	342	3	41
QJ 1036	161.0	192	268	2	11
QJ 236	175.1	198	302	3	20.5
QJ 336	196.1	198	362	3	48
QJ 1038	168.0	202	278	2	11.5
QJ 238	185.6	208	322	3	23
QJ 338	206.6	212	378	4	54.5
QJ 1040	178.6	212	298	2	15
QJ 240	196.1	218	342	3	27
QJ 340	217.1	222	398	4	61.5

Remarks When using four-point contact ball bearings, please contact NSK.

SELF-ALIGNING BALL BEARINGS

SELF-ALIGNING BALL BEARINGS Bore Diameter 5 – 110 mm..... B78

DESIGN, TYPES, AND FEATURES

The outer ring has a spherical raceway and its center of curvature coincides with that of the bearing; therefore, the axis of the inner ring, balls and cage can deflect to some extent around the bearing center. This type is recommended when the alignment of the shaft and housing is difficult and when the shaft may bend. Since the contact angle is small, the axial load capacity is low.

Pressed steel cages are usually used.

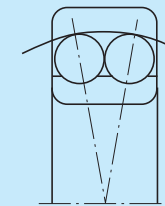

PROTRUSION AMOUNT OF BALLS

Among self-aligning ball bearings, there are some in which the balls protrude from the side face as shown below. This protrusion amount b_1 is listed in the following table.

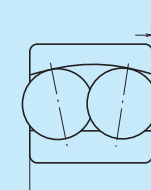

Bearing No.	b_1 (mm)
2222(K), 2316(K)	0.5
2319(K), 2320(K) 2321, 2322(K)	0.5
1318(K)	1.5
1319(K)	2
1320(K), 1321 1322(K)	3

TOLERANCES AND RUNNING

ACCURACY Table 8.2 (Pages A60 to A63)

RECOMMENDED FITS Table 9.2 (Page A84)
Table 9.4 (Page A85)

INTERNAL CLEARANCE Table 9.12 (Page A90)

PERMISSIBLE MISALIGNMENT

The permissible misalignment of self-aligning ball bearings is approximately 0.07 to 0.12 radian (4° to 7°) under normal loads. However, depending on the surrounding structure, such an angle may not be possible. Use care in the structural design.



Bore Diameter 5 – 30 mm

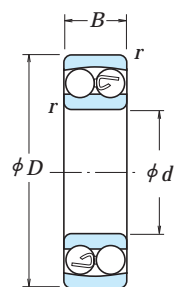

Cylindrical Bore

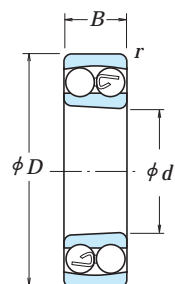

Tapered Bore

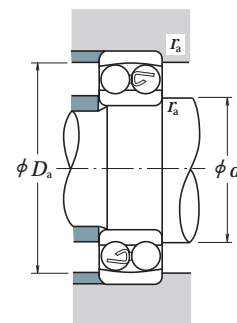

Dynamic Equivalent Load

$$P = XF_r + YF_a$$

$F_a/F_r \leq e$		$F_a/F_r > e$	
X	Y	X	Y
1	Y_3	0.65	Y_2

Static Equivalent Load

$$P_0 = F_r + Y_0 F_a$$

The values of e , Y_2 , Y_3 , and Y_0

are listed in the table below.

Boundary Dimensions (mm)				Basic Load Ratings (N)				Limiting Speeds (min ⁻¹)		Bearing Cylindrical Bore
<i>d</i>	<i>D</i>	<i>B</i>	<i>r</i> _{min.}	<i>C_r</i>	<i>C_{0r}</i>	(kgf)		Grease	Oil	
5	19	6	0.3	2 530	475	258	49	30 000	36 000	135
6	19	6	0.3	2 530	475	258	49	30 000	36 000	126
7	22	7	0.3	2 750	600	280	61	26 000	32 000	127
8	22	7	0.3	2 750	600	280	61	26 000	32 000	108
9	26	8	0.6	4 150	895	425	91	26 000	30 000	129
10	30	9	0.6	5 550	1 190	570	121	22 000	28 000	1200
	30	14	0.6	7 450	1 590	760	162	24 000	28 000	2200
	35	11	0.6	7 350	1 620	750	165	20 000	24 000	1300
	35	17	0.6	9 200	2 010	935	205	18 000	22 000	2300
12	32	10	0.6	5 700	1 270	580	130	22 000	26 000	1201
	32	14	0.6	7 750	1 730	790	177	22 000	26 000	2201
	37	12	1	9 650	2 160	985	221	18 000	22 000	1301
	37	17	1	12 100	2 730	1 240	278	17 000	22 000	2301
15	35	11	0.6	7 600	1 750	775	179	18 000	22 000	1202
	35	14	0.6	7 800	1 850	795	188	18 000	22 000	2202
	42	13	1	9 700	2 290	990	234	16 000	20 000	1302
	42	17	1	12 300	2 910	1 250	296	14 000	18 000	2302
17	40	12	0.6	8 000	2 010	815	205	16 000	20 000	1203
	40	16	0.6	9 950	2 420	1 010	247	16 000	20 000	2203
	47	14	1	12 700	3 200	1 300	325	14 000	17 000	1303
	47	19	1	14 700	3 550	1 500	365	13 000	16 000	2303
20	47	14	1	10 000	2 610	1 020	266	14 000	17 000	1204
	47	18	1	12 800	3 300	1 310	340	14 000	17 000	2204
	52	15	1.1	12 600	3 350	1 280	340	12 000	15 000	1304
	52	21	1.1	18 500	4 700	1 880	480	11 000	14 000	2304
25	52	15	1	12 200	3 300	1 250	335	12 000	14 000	1205
	52	18	1	12 400	3 450	1 270	350	12 000	14 000	2205
	62	17	1.1	18 200	5 000	1 850	510	10 000	13 000	1305
	62	24	1.1	24 900	6 600	2 530	675	9 500	12 000	2305
30	62	16	1	15 800	4 650	1 610	475	10 000	12 000	1206
	62	20	1	15 300	4 550	1 560	460	10 000	12 000	2206
	72	19	1.1	21 400	6 300	2 190	645	8 500	11 000	1306
	72	27	1.1	32 000	8 750	3 250	895	8 000	10 000	2306

Note (1) The suffix K represents bearings with tapered bores (1 : 12)

Remarks For the dimensions related to adapters, refer to Page B358.

Numbers	Abutment and Fillet Dimensions (mm)			Constant <i>e</i>	Axial Load Factors			Mass (kg)
	Tapered Bore ⁽¹⁾	<i>d_a</i> _{min.}	<i>D_a</i> _{max.}		<i>r_a</i> _{max.}	<i>Y₂</i>	<i>Y₃</i>	
—	7	17	0.3	0.34	2.9	1.9	1.9	0.009
—	8	17	0.3	0.34	2.9	1.9	1.9	0.008
—	9	20	0.3	0.31	3.1	2.0	2.1	0.013
—	10	20	0.3	0.31	3.1	2.0	2.1	0.016
—	13	22	0.6	0.32	3.1	2.0	2.1	0.021
—	14	26	0.6	0.32	3.1	2.0	2.1	0.033
—	14	26	0.6	0.64	1.5	0.98	1.0	0.042
—	14	31	0.6	0.35	2.8	1.8	1.9	0.057
—	14	31	0.6	0.71	1.4	0.89	0.93	0.077
—	16	28	0.6	0.36	2.7	1.8	1.8	0.039
—	16	28	0.6	0.58	1.7	1.1	1.1	0.048
—	17	32	1	0.33	2.9	1.9	2.0	0.066
—	17	32	1	0.60	1.6	1.1	1.1	0.082
—	19	31	0.6	0.32	3.1	2.0	2.1	0.051
—	19	31	0.6	0.50	1.9	1.3	1.3	0.055
—	20	37	1	0.33	2.9	1.9	2.0	0.093
—	20	37	1	0.51	1.9	1.2	1.3	0.108
—	21	36	0.6	0.31	3.1	2.0	2.1	0.072
—	21	36	0.6	0.50	1.9	1.3	1.3	0.085
—	22	42	1	0.32	3.1	2.0	2.1	0.13
—	22	42	1	0.51	1.9	1.2	1.3	0.15
1204 K	25	42	1	0.29	3.4	2.2	2.3	0.12
2204 K	25	42	1	0.47	2.1	1.3	1.4	0.133
1304 K	26.5	45.5	1	0.29	3.4	2.2	2.3	0.165
2304 K	26.5	45.5	1	0.50	1.9	1.2	1.3	0.193
1205 K	30	47	1	0.28	3.5	2.3	2.4	0.14
2205 K	30	47	1	0.41	2.4	1.5	1.6	0.15
1305 K	31.5	55.5	1	0.28	3.5	2.3	2.4	0.255
2305 K	31.5	55.5	1	0.47	2.1	1.4	1.4	0.319
1206 K	35	57	1	0.25	3.9	2.5	2.6	0.22
2206 K	35	57	1	0.38	2.5	1.6	1.7	0.249
1306 K	36.5	65.5	1	0.26	3.7	2.4	2.5	0.385
2306 K	36.5	65.5	1	0.44	2.2	1.4	1.5	0.48

Bore Diameter 35 – 70 mm

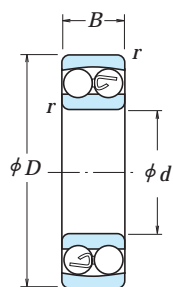

Cylindrical Bore

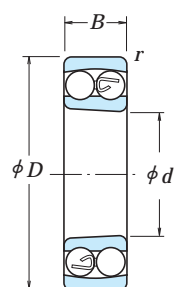

Tapered Bore

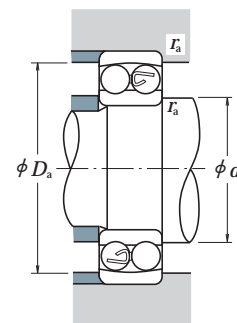

Dynamic Equivalent Load

$$P = XF_r + YF_a$$

$F_a/F_r \leq e$		$F_a/F_r > e$	
X	Y	X	Y
1	Y_3	0.65	Y_2

Static Equivalent Load

$$P_0 = F_r + Y_0 F_a$$

The values of e , Y_2 , Y_3 , and Y_0

are listed in the table below.

Boundary Dimensions (mm)				Basic Load Ratings (N)				Limiting Speeds (min ⁻¹)		Bearing Cylindrical Bore
d	D	B	r min.	C_r	C_{0r}	(kgf)		Grease	Oil	
35	72	17	1.1	15 900	5 100	1 620	520	8 500	10 000	1207
	72	23	1.1	21 700	6 600	2 210	675	8 500	10 000	2207
	80	21	1.5	25 300	7 850	2 580	800	7 500	9 500	1307
	80	31	1.5	40 000	11 300	4 100	1 150	7 100	9 000	2307
40	80	18	1.1	19 300	6 500	1 970	665	7 500	9 000	1208
	80	23	1.1	22 400	7 350	2 290	750	7 500	9 000	2208
	90	23	1.5	29 800	9 700	3 050	990	6 700	8 500	1308
	90	33	1.5	45 500	13 500	4 650	1 380	6 300	8 000	2308
45	85	19	1.1	22 000	7 350	2 240	750	7 100	8 500	1209
	85	23	1.1	23 300	8 150	2 380	830	7 100	8 500	2209
	100	25	1.5	38 500	12 700	3 900	1 300	6 000	7 500	1309
	100	35	1.5	55 000	16 700	5 600	1 700	5 600	7 100	2309
50	90	20	1.1	22 800	8 100	2 330	830	6 300	8 000	1210
	90	23	1.1	23 300	8 450	2 380	865	6 300	8 000	2210
	110	27	2	43 500	14 100	4 450	1 440	5 600	6 700	1310
	110	40	2	65 000	20 200	6 650	2 060	5 000	6 300	2310
55	100	21	1.5	26 900	10 000	2 750	1 020	6 000	7 100	1211
	100	25	1.5	26 700	9 900	2 720	1 010	6 000	7 100	2211
	120	29	2	51 500	17 900	5 250	1 820	5 000	6 300	1311
	120	43	2	76 500	24 000	7 800	2 450	4 800	6 000	2311
60	110	22	1.5	30 500	11 500	3 100	1 180	5 300	6 300	1212
	110	28	1.5	34 000	12 600	3 500	1 290	5 300	6 300	2212
	130	31	2.1	57 500	20 800	5 900	2 130	4 500	5 600	1312
	130	46	2.1	88 500	28 300	9 000	2 880	4 300	5 300	2312
65	120	23	1.5	31 000	12 500	3 150	1 280	4 800	6 000	1213
	120	31	1.5	43 500	16 400	4 450	1 670	4 800	6 000	2213
	140	33	2.1	62 500	22 900	6 350	2 330	4 300	5 300	1313
	140	48	2.1	97 000	32 500	9 900	3 300	3 800	4 800	2313
70	125	24	1.5	35 000	13 800	3 550	1 410	4 800	5 600	1214
	125	31	1.5	44 000	17 100	4 500	1 740	4 500	5 600	2214
	150	35	2.1	75 000	27 700	7 650	2 830	4 000	5 000	1314
	150	51	2.1	111 000	37 500	11 300	3 850	3 600	4 500	2314

Note (1) The suffix K represents bearings with tapered bores (1 : 12)

Remarks For the dimensions related to adapters, refer to Page B358 and B359.

Numbers	Abutment and Fillet Dimensions (mm)			Constant e	Axial Load Factors			Mass (kg) approx.	
	Tapered Bore ⁽¹⁾	d_a min.	D_a max.		r_a max.	Y_2	Y_3		Y_0
1207 K	—	41.5	65.5	1	0.23	4.2	2.7	2.8	0.32
	—	41.5	65.5	1	0.37	2.6	1.7	1.8	0.378
	—	43	72	1.5	0.26	3.8	2.5	2.6	0.51
	—	43	72	1.5	0.46	2.1	1.4	1.4	0.642
1208 K	—	46.5	73.5	1	0.22	4.3	2.8	2.9	0.415
	—	46.5	73.5	1	0.33	3.0	1.9	2.0	0.477
	—	48	82	1.5	0.24	4.0	2.6	2.7	0.715
	—	48	82	1.5	0.43	2.3	1.5	1.5	0.889
1209 K	—	51.5	78.5	1	0.21	4.7	3.0	3.1	0.465
	—	51.5	78.5	1	0.30	3.2	2.1	2.2	0.522
	—	53	92	1.5	0.25	4.0	2.6	2.7	0.955
	—	53	92	1.5	0.41	2.4	1.5	1.6	1.2
1210 K	—	56.5	83.5	1	0.21	4.7	3.1	3.2	0.525
	—	56.5	83.5	1	0.28	3.4	2.2	2.3	0.564
	—	59	101	2	0.23	4.2	2.7	2.8	1.25
	—	59	101	2	0.42	2.3	1.5	1.6	1.58
1211 K	—	63	92	1.5	0.20	4.9	3.2	3.3	0.705
	—	63	92	1.5	0.28	3.5	2.3	2.4	0.746
	—	64	111	2	0.23	4.2	2.7	2.8	1.6
	—	64	111	2	0.41	2.4	1.5	1.6	2.03
1212 K	—	68	102	1.5	0.18	5.3	3.4	3.6	0.90
	—	68	102	1.5	0.28	3.5	2.3	2.4	1.03
	—	71	119	2	0.23	4.3	2.8	2.9	2.03
	—	71	119	2	0.40	2.4	1.6	1.6	2.57
1213 K	—	73	112	1.5	0.17	5.7	3.7	3.8	1.15
	—	73	112	1.5	0.28	3.5	2.3	2.4	1.4
	—	76	129	2	0.23	4.2	2.7	2.9	2.54
	—	76	129	2	0.39	2.5	1.6	1.7	3.2
—	—	78	117	1.5	0.18	5.3	3.4	3.6	1.3
	—	78	117	1.5	0.26	3.7	2.4	2.5	1.52
	—	81	139	2	0.22	4.4	2.8	3.0	3.19
	—	81	139	2	0.38	2.6	1.7	1.8	3.9

Bore Diameter 75 – 110 mm

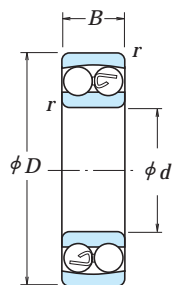

Cylindrical Bore

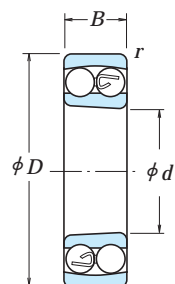

Tapered Bore

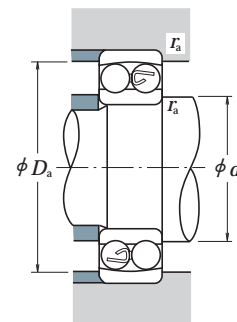

Dynamic Equivalent Load

$$P = XF_r + YF_a$$

$F_a / F_r \leq e$		$F_a / F_r > e$	
X	Y	X	Y
1	Y_3	0.65	Y_2

Static Equivalent Load

$$P_0 = F_r + Y_0 F_a$$

The values of e , Y_2 , Y_3 , and Y_0

are listed in the table below.

Boundary Dimensions (mm)				Basic Load Ratings (N) (kgf)				Limiting Speeds (min ⁻¹)		Bearing Cylindrical Bore
d	D	B	r min.	C_r	C_{0r}	C_r	C_{0r}	Grease	Oil	
75	130	25	1.5	39 000	15 700	4 000	1 600	4 300	5 300	1215
	130	31	1.5	44 500	17 800	4 550	1 820	4 300	5 300	2215
	160	37	2.1	80 000	30 000	8 150	3 050	3 800	4 500	1315
	160	55	2.1	125 000	43 000	12 700	4 400	3 400	4 300	2315
80	140	26	2	40 000	17 000	4 100	1 730	4 000	5 000	1216
	140	33	2	49 000	19 900	5 000	2 030	4 000	5 000	2216
	170	39	2.1	89 000	33 000	9 100	3 400	3 600	4 300	1316
	170	58	2.1	130 000	45 000	13 200	4 600	3 200	4 000	* 2316
85	150	28	2	49 500	20 800	5 050	2 120	3 800	4 500	1217
	150	36	2	58 500	23 600	5 950	2 400	3 800	4 800	2217
	180	41	3	98 500	38 000	10 000	3 850	3 400	4 000	1317
	180	60	3	142 000	51 500	14 500	5 250	3 000	3 800	2317
90	160	30	2	57 500	23 500	5 850	2 400	3 600	4 300	1218
	160	40	2	70 500	28 700	7 200	2 930	3 600	4 300	2218
	190	43	3	117 000	44 500	12 000	4 550	3 200	3 800	* 1318
	190	64	3	154 000	57 500	15 700	5 850	2 800	3 600	2318
95	170	32	2.1	64 000	27 100	6 550	2 770	3 400	4 000	1219
	170	43	2.1	84 000	34 500	8 550	3 500	3 400	4 000	2219
	200	45	3	129 000	51 000	13 200	5 200	3 000	3 600	* 1319
	200	67	3	161 000	64 500	16 400	6 550	2 800	3 400	* 2319
100	180	34	2.1	69 500	29 700	7 100	3 050	3 200	3 800	1220
	180	46	2.1	94 500	38 500	9 650	3 900	3 200	3 800	2220
	215	47	3	140 000	57 500	14 300	5 850	2 800	3 400	* 1320
	215	73	3	187 000	79 000	19 100	8 050	2 400	3 200	* 2320
105	190	36	2.1	75 000	32 500	7 650	3 300	3 000	3 600	1221
	190	50	2.1	109 000	45 000	11 100	4 550	3 000	3 600	2221
	225	49	3	154 000	64 500	15 700	6 600	2 600	3 200	* 1321
	225	77	3	200 000	87 000	20 400	8 850	2 400	3 000	* 2321
110	200	38	2.1	87 000	38 500	8 900	3 950	2 800	3 400	1222
	200	53	2.1	122 000	51 500	12 500	5 250	2 800	3 400	* 2222
	240	50	3	161 000	72 000	16 400	7 300	2 400	3 000	* 1322
	240	80	3	211 000	94 500	21 600	9 650	2 200	2 800	* 2322

Numbers	Abutment and Fillet Dimensions (mm)			Constant e	Axial Load Factors			Mass (kg) approx.	
	Tapered Bore ⁽¹⁾	d_a min.	D_a max.		r_a max.	Y_2	Y_3		Y_0
1215 K	—	83	122	1.5	0.17	5.6	3.6	3.8	1.41
	—	83	122	1.5	0.25	3.9	2.5	2.6	1.6
	—	86	149	2	0.22	4.4	2.8	2.9	3.65
	—	86	149	2	0.38	2.5	1.6	1.7	4.77
1216 K	—	89	131	2	0.16	6.0	3.9	4.1	1.73
	—	89	131	2	0.25	3.9	2.5	2.7	1.97
	—	91	159	2	0.22	4.5	2.9	3.1	4.31
	—	91	159	2	0.39	2.5	1.6	1.7	5.54
1217 K	—	94	141	2	0.17	5.7	3.7	3.8	2.09
	—	94	141	2	0.25	3.9	2.5	2.6	2.48
	—	98	167	2.5	0.21	4.6	2.9	3.1	5.13
	—	98	167	2.5	0.37	2.6	1.7	1.8	6.56
1218 K	—	99	151	2	0.17	5.8	3.8	3.9	2.55
	—	99	151	2	0.27	3.7	2.4	2.5	3.13
	—	103	177	2.5	0.22	4.3	2.8	2.9	5.94
	—	103	177	2.5	0.38	2.6	1.7	1.7	7.76
1219 K	—	106	159	2	0.17	5.8	3.7	3.9	3.21
	—	106	159	2	0.27	3.7	2.4	2.5	3.87
	—	108	187	2.5	0.23	4.3	2.8	2.9	6.84
	—	108	187	2.5	0.38	2.6	1.7	1.8	9.01
1220 K	—	111	169	2	0.17	5.6	3.6	3.8	3.82
	—	111	169	2	0.27	3.7	2.4	2.5	4.53
	—	113	202	2.5	0.24	4.1	2.7	2.8	8.46
	—	113	202	2.5	0.38	2.6	1.7	1.8	11.6
1221 K	—	116	179	2	0.18	5.5	3.6	3.7	4.52
	—	116	179	2	0.28	3.5	2.3	2.4	5.64
	—	118	212	2.5	0.23	4.2	2.7	2.9	10
	—	118	212	2.5	0.38	2.6	1.7	1.7	14.4
1222 K	—	121	189	2	0.17	5.7	3.7	3.9	5.33
	—	121	189	2	0.28	3.5	2.2	2.3	6.64
	—	123	227	2.5	0.22	4.4	2.8	3.0	12
	—	123	227	2.5	0.37	2.6	1.7	1.8	17.4

Notes ⁽¹⁾ The suffix K represents bearings with tapered bores (1 : 12)

(*) The balls of the bearings marked * protrude slightly from the bearing face. The protrusion amounts are shown on

Page B77.

Remarks For the dimensions related to adapters, refer to Pages B360 and B361.

CYLINDRICAL ROLLER BEARINGS

SINGLE-ROW CYLINDRICAL ROLLER BEARINGS	Bore Diameter 20 – 65mm.....	B 88
	Bore Diameter 70 – 160mm.....	B 94
	Bore Diameter 170 – 500mm.....	B102
L-SHAPED THRUST COLLARS FOR CYLINDRICAL ROLLER BEARINGS	Bore Diameter 20 – 320mm.....	B106
DOUBLE-ROW CYLINDRICAL ROLLER BEARINGS	Bore Diameter 25 – 360mm.....	B110

Four-Row Cylindrical Roller Bearings are described on Pages B334 to B343.

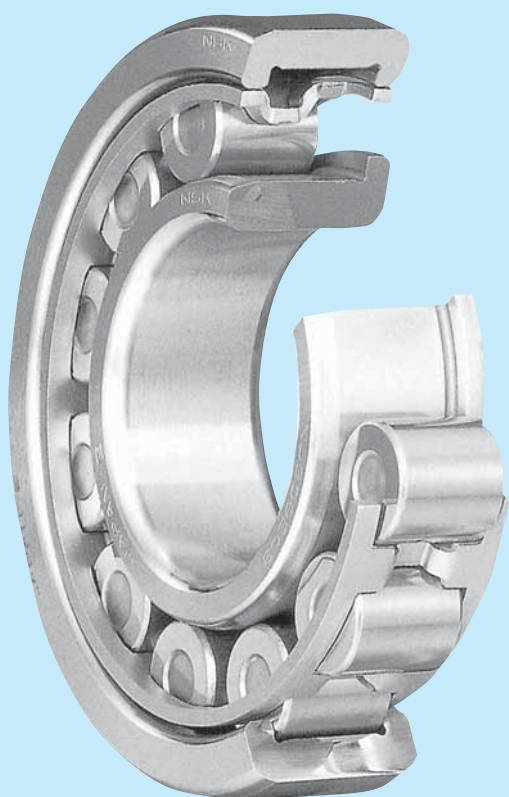

DESIGN, TYPES, AND FEATURES

Depending on the existence of ribs on their rings, Cylindrical Roller Bearings are classified into the following types.

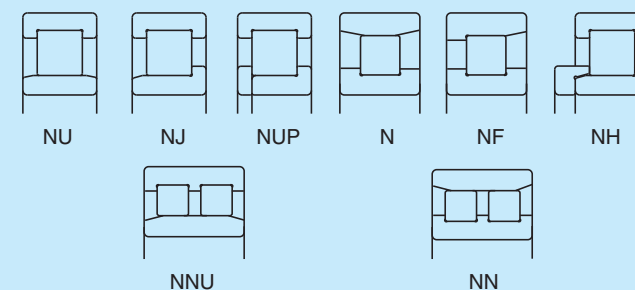

Types NU, N, NNU, and NN are suitable as free-end bearings. Types NJ and NF can sustain limited axial loads in one direction. Types NH and NUP can be used as fixed-end bearings.

NH-type cylindrical roller bearings consist of the NJ-type cylindrical roller bearings and HJ-type L-shaped thrust collars (See Page B104 to B105).

The inner ring loose rib of a NUP-type cylindrical roller bearing should be mounted so that the marked side is on the outside.

Use pressed, machined, or molded cages for standard cylindrical roller bearings as shown in Table 1.

Table 1 Standard Cages for Cylindrical Roller Bearings

Series	Pressed Steel Cages (W)	Machined Brass Cages (M)	Molded Polyamide Cages (T)
NU10**	—	1005 – 10/500	—
N2**	204 – 230	232 – 264	—
NU2**	214 – 230	232 – 264	—
NU2**E	205E – 213E	214E – 240E	204E
NU22**	2204 – 2230	2232 – 2252	—
NU22**E	—	2222E – 2240E	2204E – 2220E
N3**	304 – 324	326 – 352	—
NU3**	312 – 330	332 – 352	—
NU3**E	305E – 311E	312E – 340E	304E
NU23**	2304 – 2320	2322 – 2340	—
NU23**E	—	2322E – 2340E	2304E – 2320E
NU4**	405 – 416	417 – 430	—

The basic load ratings listed in the bearing tables are based on the Cage Classification in Table 1.

For a given bearing number, if the type of cage is not the standard one, the number of rollers may vary; in such a case, the load rating will differ from the one listed in the bearing tables.

Among the NN Type of double-row bearings, there are many of high precision that have tapered bores, and they are primarily used in the main spindles of machine tools. Their cages are either molded polyphenylenesulfide (PPS) or machined brass.

PRECAUTIONS FOR USE OF CYLINDRICAL ROLLER BEARINGS

If the load on cylindrical roller bearings becomes too small during operation, slippage between the rollers and raceways occurs, which may result in smearing. Especially with large bearings since the weight of the roller and cage is high.

In case of strong shock loads or vibration, pressed-steel cages are sometimes inadequate.

If very small bearing load or strong shock loads or vibration are expected, please consult with NSK for selection of the bearings.

Bearings with molded polyamide cages (ET type) can be used continuously at temperatures between -40 and 120°C. If the bearings are used in gear oil, nonflammable hydraulic oil, or ester oil at a high temperature over 100°C, please contact NSK beforehand.

TOLERANCES AND RUNNING ACCURACY

CYLINDRICAL ROLLER BEARINGS Table 8.2 (Pages A60 to A63)

DOUBLE-ROW CYLINDRICAL ROLLER

BEARINGS Table 8.2 (Pages A60 to A63)

Table 2 Tolerances for Roller Inscribed Circle Diameter F_w and Roller Circumscribed Circle Diameter E_w of Cylindrical Roller Bearings Having Interchangeable Rings
Units : μm

Nominal Bore Diameter d (mm)		Tolerances for F_w of types NU, NJ, NUP, NH, and NNU ΔF_w		Tolerances for E_w of types N, NF, and NN ΔE_w	
over	incl.	high	low	high	low
—	20	+10	0	0	-10
20	50	+15	0	0	-15
50	120	+20	0	0	-20
120	200	+25	0	0	-25
200	250	+30	0	0	-30
250	315	+35	0	0	-35
315	400	+40	0	0	-40
400	500	+45	0	—	—

RECOMMENDED FITS

CYLINDRICAL ROLLER BEARINGS Table 9.2 (Page A84)
Table 9.4 (Page A85)

DOUBLE-ROW CYLINDRICAL ROLLER

BEARINGS Table 9.2 (Page A84)
Table 9.4 (Page A85)

INTERNAL CLEARANCES

CYLINDRICAL ROLLER BEARINGS Table 9.14 (Page A91)
DOUBLE-ROW CYLINDRICAL ROLLER BEARINGS Table 9.14 (Page A91)

PERMISSIBLE MISALIGNMENT

The permissible misalignment of cylindrical roller bearings varies depending on the type and internal specifications, but under normal loads, the angles are approximately as follows:

Cylindrical Roller Bearings of width series 0 or 1 0.0012 radian (4')

Cylindrical Roller Bearings of width series 2 0.0006 radian (2')

For double-row cylindrical roller bearings, nearly no misalignment is allowed.

LIMITING SPEEDS

The limiting speeds listed in the bearing tables should be adjusted depending on the bearing load conditions. Also, higher speeds are attainable by making changes in the lubrication method, cage design, etc. Refer to Page A37 for detailed information.

Bore Diameter 20 – 35 mm

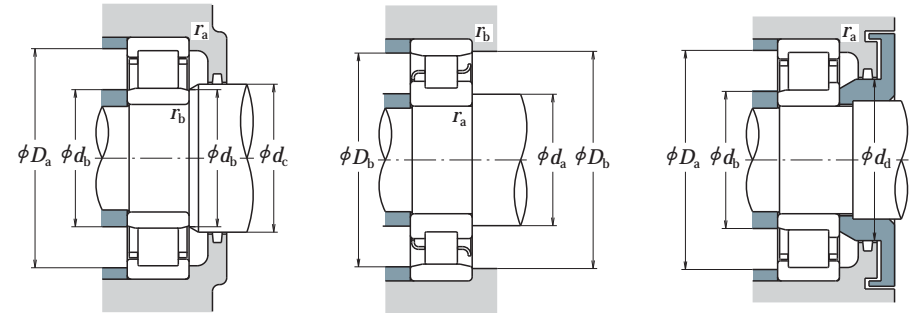
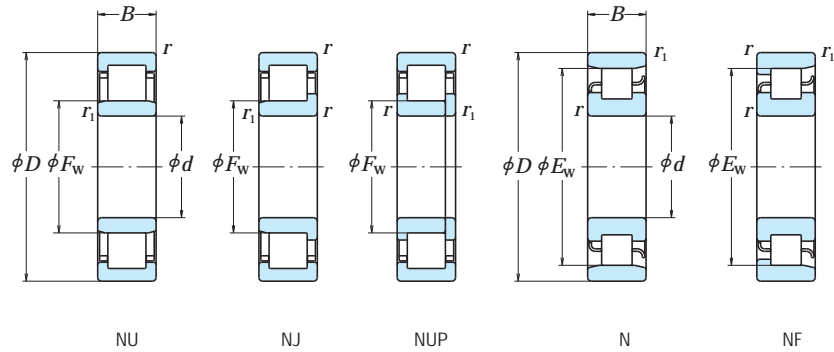

d	Boundary Dimensions (mm)						Basic Load Ratings (N)		Limiting Speeds ⁽¹⁾ (min ⁻¹)		
	D	B	r min.	r ₁ min.	F _W	E _W	C _r	C _{0r}	Grease	Oil	
20	47	14	1	0.6	—	40	15 400	12 700	15 000	18 000	
	47	14	1	0.6	26.5	—	25 700	22 600	13 000	16 000	
	47	18	1	0.6	27	—	20 700	18 400	13 000	16 000	
	47	18	1	0.6	26.5	—	30 500	28 300	13 000	16 000	
	52	15	1.1	0.6	—	44.5	21 400	17 300	12 000	15 000	
	52	15	1.1	0.6	27.5	—	31 500	26 900	12 000	15 000	
	52	21	1.1	0.6	28.5	—	30 500	27 200	11 000	14 000	
	52	21	1.1	0.6	27.5	—	42 000	39 000	11 000	14 000	
	25	47	12	0.6	0.3	30.5	—	14 300	13 100	15 000	18 000
		52	15	1	0.6	—	45	17 700	15 700	13 000	16 000
52		15	1	0.6	31.5	—	29 300	27 700	12 000	14 000	
52		18	1	0.6	31.5	—	35 000	34 500	12 000	14 000	
62		17	1.1	1.1	—	53	29 300	25 200	10 000	13 000	
62		17	1.1	1.1	34	—	41 500	37 500	10 000	12 000	
62		24	1.1	1.1	34	—	57 000	56 000	9 000	11 000	
80		21	1.5	1.5	38.8	62.8	46 500	40 000	9 000	11 000	
30		55	13	1	0.6	36.5	48.5	19 700	19 600	12 000	15 000
		62	16	1	0.6	—	53.5	24 900	23 300	11 000	13 000
	62	16	1	0.6	37.5	—	39 000	37 500	9 500	12 000	
	62	20	1	0.6	37.5	—	49 000	50 000	9 500	12 000	
	72	19	1.1	1.1	—	62	38 500	35 000	8 500	11 000	
	72	19	1.1	1.1	40.5	—	53 000	50 000	8 500	10 000	
	72	27	1.1	1.1	40.5	—	74 500	77 500	8 000	9 500	
	90	23	1.5	1.5	45	73	62 500	55 000	7 500	9 500	
	35	62	14	1	0.6	42	55	22 600	23 200	11 000	13 000
		72	17	1.1	0.6	—	61.8	35 500	34 000	9 500	11 000
72		17	1.1	0.6	44	—	50 500	50 000	8 500	10 000	
72		23	1.1	0.6	44	—	61 500	65 500	8 500	10 000	
80		21	1.5	1.1	—	68.2	49 500	47 000	8 000	9 500	
80		21	1.5	1.1	46.2	—	66 500	65 500	7 500	9 500	
80		31	1.5	1.1	46.2	—	93 000	101 000	6 700	8 500	
100		25	1.5	1.5	53	83	75 500	69 000	6 700	8 000	

Bearing Numbers ⁽²⁾	Abutment and Fillet Dimensions (mm)										Mass (kg) approx.					
	Bearing Numbers ⁽³⁾					d _a ⁽⁴⁾ min.	d _b min.	d _b ⁽⁵⁾ max.	d _c min.	d _d min.		D _a ⁽⁴⁾ max.	D _b max.	D _b min.	r _a max.	r _b max.
N 204	—	—	—	N	NF	25	—	—	—	—	—	43	42	1	0.6	0.107
NU 204 ET	NU	NJ	NUP	—	—	25	24	25	29	32	42	—	—	1	0.6	0.107
NU2204	NU	NJ	—	—	—	25	24	25	29	32	42	—	—	1	0.6	0.144
NU2204 ET	NU	NJ	NUP	—	—	25	24	25	29	32	42	—	—	1	0.6	0.138
N 304	—	—	—	N	NF	26.5	—	—	—	—	—	48	46	1	0.6	0.148
NU 304 ET	NU	NJ	NUP	—	—	26.5	24	26	30	33	45.5	—	—	1	0.6	0.145
NU2304	NU	NJ	NUP	—	—	26.5	24	27	30	33	45.5	—	—	1	0.6	0.217
NU2304 ET	NU	NJ	NUP	—	—	26.5	24	26	30	33	45.5	—	—	1	0.6	0.209
NU1005	NU	—	—	—	—	—	27	30	32	—	43	—	—	0.6	0.3	0.094
N 205	—	—	—	N	NF	30	—	—	—	—	—	48	46	1	0.6	0.135
NU 205 EW	NU	NJ	NUP	—	—	30	29	30	34	37	47	—	—	1	0.6	0.136
NU2205 ET	NU	NJ	NUP	—	—	30	29	30	34	37	47	—	—	1	0.6	0.16
N 305	—	—	—	N	NF	31.5	—	—	—	—	—	55.5	50	1	1	0.233
NU 305 EW	NU	NJ	NUP	—	—	31.5	31.5	32	37	40	55.5	—	—	1	1	0.269
NU2305 ET	NU	NJ	NUP	—	—	31.5	31.5	32	37	40	55.5	—	—	1	1	0.338
NU 405	NU	NJ	—	N	NF	33	33	37	41	46	72	72	64	1.5	1.5	0.57
NU1006	NU	—	—	N	—	35	34	36	38	—	50	51	49	1	0.5	0.136
N 206	—	—	—	N	NF	35	—	—	—	—	—	58	56	1	0.6	0.208
NU 206 EW	NU	NJ	NUP	—	—	35	34	36	40	44	57	—	—	1	0.6	0.205
NU2206 ET	NU	NJ	NUP	—	—	35	34	36	40	44	57	—	—	1	0.6	0.255
N 306	—	—	—	N	NF	36.5	—	—	—	—	—	65.5	64	1	1	0.353
NU 306 EW	NU	NJ	NUP	—	—	36.5	36.5	39	44	48	65.5	—	—	1	1	0.409
NU2306 ET	NU	NJ	NUP	—	—	36.5	36.5	39	44	48	65.5	—	—	1	1	0.518
NU 406	NU	NJ	—	N	NF	38	38	43	47	52	82	82	75	1.5	1.5	0.758
NU1007	NU	NJ	—	N	—	40	39	41	44	—	57	58	56	1	0.5	0.18
N 207	—	—	—	N	NF	41.5	—	—	—	—	—	68	64	1	0.6	0.301
NU 207 EW	NU	NJ	NUP	—	—	41.5	39	42	46	50	65.5	—	—	1	0.6	0.304
NU2207 ET	NU	NJ	NUP	—	—	41.5	39	42	46	50	65.5	—	—	1	0.6	0.40
N 307	—	—	—	N	NF	43	—	—	—	—	—	73.5	70	1.5	1	0.476
NU 307 EW	NU	NJ	NUP	—	—	41.5	41.5	44	48	53	72	—	—	1.5	1	0.545
NU2307 ET	NU	NJ	NUP	—	—	43	41.5	44	48	53	72	—	—	1.5	1	0.711
NU 407	NU	NJ	—	N	NF	43	43	51	55	61	92	92	85	1.5	1.5	1.01

Notes ⁽¹⁾ The limiting speeds listed above apply to bearings with machined cages (No suffix). For bearings with pressed cages, reduce the limiting speed by 20%. (Not applicable to bearing numbers with an EM, EW, or ET suffix.)
⁽²⁾ The bearings with suffix ET have polyamide cage. The maximum operating temperature should be less than 120 °C.

Notes ⁽³⁾ When L-shaped thrust collars (See section for L-Shaped Thrust Collars starting on page B104) are used, the bearings become the NH type.
⁽⁴⁾ If axial loads are applied, increase d_a and reduce D_a from the values listed above.
⁽⁵⁾ d_b (max.) are values for adjusting rings for NU, NJ Types.

Bore Diameter 40 – 55 mm

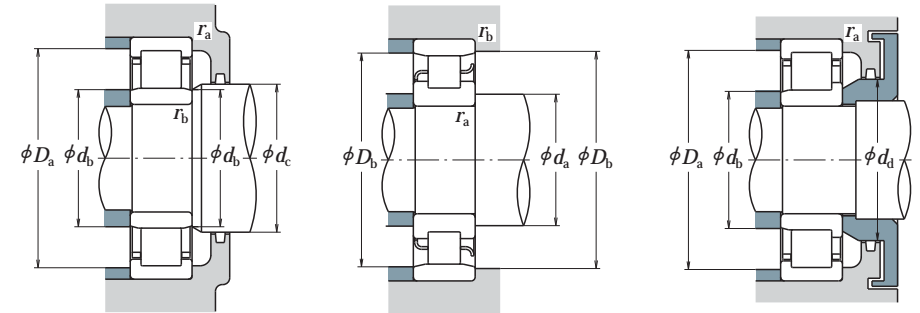
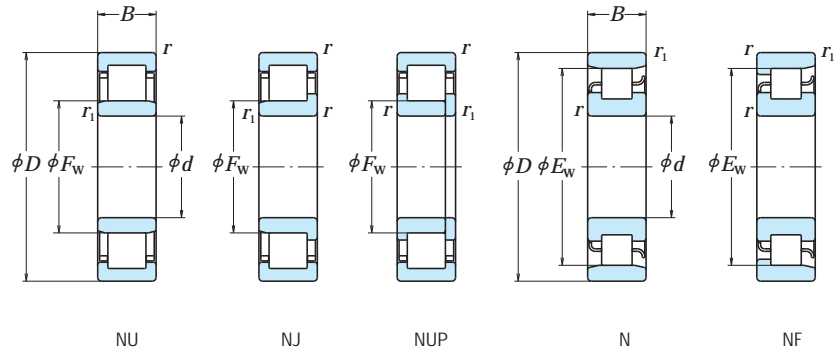

d	Boundary Dimensions (mm)						Basic Load Ratings (N)		Limiting Speeds ⁽¹⁾ (min ⁻¹)	
	D	B	r min.	r ₁ min.	F _W	E _W	C _r	C _{0r}	Grease	Oil
40	68	15	1	0.6	47	61	27 300	29 000	10 000	12 000
	80	18	1.1	1.1	—	70	43 500	43 000	8 500	10 000
	80	18	1.1	1.1	49.5	—	55 500	55 500	7 500	9 000
	80	23	1.1	1.1	49.5	—	72 500	77 500	7 500	9 000
	90	23	1.5	1.5	—	77.5	58 500	57 000	6 700	8 500
45	75	16	1	0.6	52.5	67.5	32 500	35 500	9 000	11 000
	85	19	1.1	1.1	—	75	46 000	47 000	7 500	9 000
	85	19	1.1	1.1	54.5	—	63 000	66 500	6 700	8 000
	85	23	1.1	1.1	54.5	—	76 000	84 500	6 700	8 500
	100	25	1.5	1.5	—	86.5	79 000	77 500	6 300	7 500
50	80	16	1	0.6	58.5	—	137 000	153 000	5 300	6 700
	90	20	1.1	1.1	—	80.4	48 000	51 000	7 100	8 500
	90	20	1.1	1.1	59.5	—	69 000	76 500	6 300	7 500
	110	27	2	2	—	95	87 000	86 000	5 600	6 700
	110	27	2	2	65	—	110 000	113 000	5 000	6 000
55	90	18	1.1	1	64.5	80.5	37 500	44 000	7 500	9 000
	100	21	1.5	1.1	—	88.5	58 000	62 500	6 300	7 500
	100	21	1.5	1.1	66	—	86 500	98 500	5 600	7 100
	120	29	2	2	—	104.5	111 000	111 000	5 000	6 300
	120	29	2	2	70.5	—	137 000	143 000	4 500	5 600

Bearing Numbers ⁽²⁾	Abutment and Fillet Dimensions (mm)										Mass (kg) approx.				
	NU	NJ	NUP	N	NF	d _a ⁽⁴⁾ min.	d _b min.	d _b ⁽⁵⁾ max.	d _c	d _d min.		D _a ⁽⁴⁾ max.	D _b max.	D _b min.	r _a max.
NU1008	NU	NJ	NUP	N	—	45	44	46	49	—	63	64	62	1	0.6
N 208	—	—	—	N	NF	46.5	—	—	—	—	—	73.5	72	1	1
NU 208 EW	NU	NJ	NUP	—	—	46.5	46.5	48	52	56	73.5	—	—	1	1
NU2208 ET	NU	NJ	NUP	—	—	46.5	46.5	48	52	56	73.5	—	—	1	1
N 308	—	—	—	N	NF	48	—	—	—	—	—	82	79	1.5	1.5
NU 308 EW	NU	NJ	NUP	—	—	48	48	50	55	60	82	—	—	1.5	1.5
NU2308 ET	NU	NJ	NUP	—	—	48	48	50	55	60	82	—	—	1.5	1.5
NU 408	NU	NJ	NUP	N	NF	49	49	56	60	67	101	101	94	2	2
NU1009	NU	—	—	N	NF	50	49	51	54	—	70	71	68	1	0.6
N 209	—	—	—	N	NF	51.5	—	—	—	—	—	78.5	77	1	1
NU 209 EW	NU	NJ	NUP	—	—	51.5	51.5	52	57	61	78.5	—	—	1	1
NU2209 ET	NU	NJ	NUP	—	—	51.5	51.5	52	57	61	78.5	—	—	1	1
N 309	—	—	—	N	NF	53	—	—	—	—	—	92	77	1.5	1.5
NU 309 EW	NU	NJ	NUP	—	—	53	53	56	60	66	92	—	—	1.5	1.5
NU2309 ET	NU	NJ	NUP	—	—	53	53	56	60	66	92	—	—	1.5	1.5
NU 409	NU	NJ	NUP	N	NF	54	54	62	66	74	111	111	103	2	2
NU1010	NU	NJ	NUP	N	—	55	54	56	59	—	75	76	73	1	0.6
N 210	—	—	—	N	NF	56.5	—	—	—	—	—	83.5	82	1	1
NU 210 EW	NU	NJ	NUP	—	—	56.5	56.5	57	62	67	83.5	—	—	1	1
NU2210 ET	NU	NJ	NUP	—	—	56.5	56.5	57	62	67	83.5	—	—	1	1
N 310	—	—	—	N	NF	59	—	—	—	—	—	101	97	2	2
NU 310 EW	NU	NJ	NUP	—	—	59	59	63	67	73	101	—	—	2	2
NU2310 ET	NU	NJ	NUP	—	—	59	59	63	67	73	101	—	—	2	2
N 410	—	—	—	N	NF	65	—	—	—	—	—	117	113	2	2
NU 410	NU	NJ	NUP	N	NF	61	61	68	73	81	119	119	113.3	2	2
NU1011	NU	NJ	—	N	—	61.5	60	63	66	—	83.5	85	82	1	1
N 211	—	—	—	N	NF	63	—	—	—	—	—	93.5	91	1.5	1
NU 211 EW	NU	NJ	NUP	—	—	63	61.5	64	68	73	92	—	—	1.5	1
NU2211 ET	NU	NJ	NUP	—	—	63	61.5	64	68	73	92	—	—	1.5	1
N 311	—	—	—	N	NF	64	—	—	—	—	—	111	107	2	2
NU 311 EW	NU	NJ	NUP	—	—	64	64	68	72	80	111	—	—	2	2
NU2311 ET	NU	NJ	NUP	—	—	64	64	68	72	80	111	—	—	2	2
NU 411	NU	NJ	NUP	N	NF	66	66	75	79	87	129	129	119	2	2

Notes (1) The limiting speeds listed above apply to bearings with machined cages (No suffix). For bearings with pressed cages, reduce the limiting speed by 20%. (Not applicable to bearing numbers with an EM, EW, or ET suffix.)
 (2) The bearings with suffix ET have polyamide cage. The maximum operating temperature should be less than 120 °C.

Notes (3) When L-shaped thrust collars (See section for L-Shaped Thrust Collars starting on page B104) are used, the bearings become the NH type.
 (4) If axial loads are applied, increase d_a and reduce D_a from the values listed above.
 (5) d_b (max.) are values for adjusting rings for NU, NJ Types.

Bore Diameter 60 – 75 mm

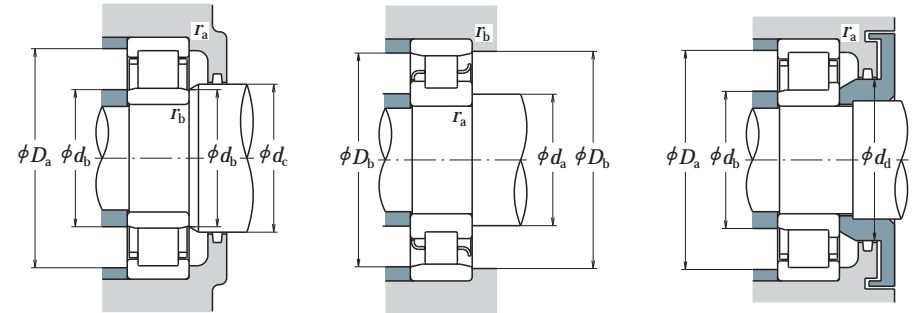
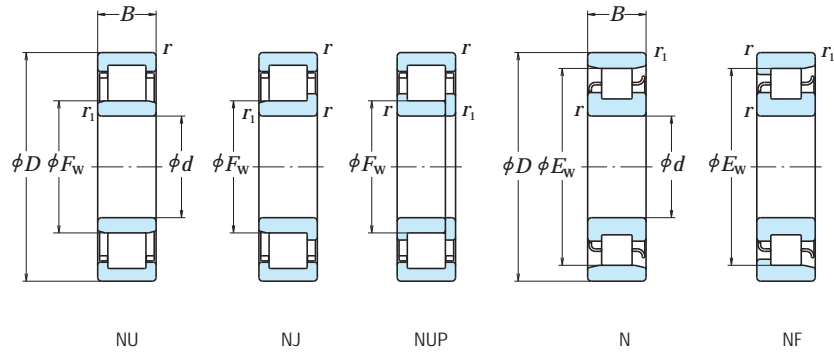

d	Boundary Dimensions (mm)						Basic Load Ratings (N)		Limiting Speeds ⁽¹⁾ (min ⁻¹)	
	D	B	r min.	r ₁ min.	F _w	E _w	C _r	C _{0r}	Grease	Oil
60	95	18	1.1	1	69.5	85.5	40 000	48 500	6 700	8 500
	110	22	1.5	1.5	—	97.5	68 500	75 000	6 000	7 100
	110	22	1.5	1.5	72	—	97 500	107 000	5 300	6 300
	110	28	1.5	1.5	72	—	131 000	157 000	5 300	6 300
	130	31	2.1	2.1	—	113	124 000	126 000	4 800	5 600
	130	31	2.1	2.1	77	—	124 000	126 000	4 800	5 600
	130	31	2.1	2.1	77	—	150 000	157 000	4 800	5 600
	130	46	2.1	2.1	77	—	222 000	262 000	4 300	5 300
	150	35	2.1	2.1	83	127	167 000	168 000	4 300	5 300
	65	100	18	1.1	1	74.5	90.5	41 000	51 000	6 300
120		23	1.5	1.5	—	105.6	84 000	94 500	5 300	6 300
120		23	1.5	1.5	78.5	—	108 000	119 000	4 800	5 600
120		31	1.5	1.5	78.5	—	149 000	181 000	4 800	6 000
140		33	2.1	2.1	—	121.5	135 000	139 000	4 300	5 300
140		33	2.1	2.1	83.5	—	135 000	139 000	4 300	5 300
140		33	2.1	2.1	82.5	—	181 000	191 000	4 300	5 300
140		48	2.1	2.1	82.5	—	233 000	265 000	3 800	4 800
160		37	2.1	2.1	89.3	135.3	182 000	186 000	4 000	4 800
70		110	20	1.1	1	80	100	58 500	74 500	6 000
	125	24	1.5	1.5	—	110.5	83 500	95 000	5 000	6 300
	125	24	1.5	1.5	83.5	—	119 000	137 000	5 000	6 300
	125	31	1.5	1.5	83.5	—	156 000	194 000	4 500	5 600
	150	35	2.1	2.1	—	130	149 000	156 000	4 000	5 000
	150	35	2.1	2.1	90	—	158 000	168 000	4 000	5 000
	150	35	2.1	2.1	89	—	205 000	222 000	4 000	5 000
	150	51	2.1	2.1	89	—	274 000	325 000	3 600	4 500
	180	42	3	3	100	152	228 000	236 000	3 600	4 300
	75	115	20	1.1	1	85	105	60 000	74 500	5 600
130		25	1.5	1.5	—	116.5	96 500	111 000	4 800	6 000
130		25	1.5	1.5	88.5	—	130 000	156 000	4 800	6 000
130		31	1.5	1.5	88.5	—	162 000	207 000	4 300	5 300
160		37	2.1	2.1	—	139.5	179 000	189 000	3 800	4 800
160		37	2.1	2.1	95.5	—	179 000	189 000	3 800	4 800
160		37	2.1	2.1	95	—	240 000	263 000	3 800	4 800
160		55	2.1	2.1	95	—	330 000	395 000	3 400	4 300
190		45	3	3	104.5	160.5	262 000	274 000	3 400	4 000

Bearing Numbers ⁽²⁾						Abutment and Fillet Dimensions (mm)										Mass (kg) approx.
⁽³⁾						d _a ⁽⁴⁾ min.	d _b min.	d _b ⁽⁵⁾ max.	d _c min.	d _d min.	D _a ⁽⁴⁾ max.	D _b max.	D _b min.	r _a max.	r _b max.	
NU1012	NU	NJ	—	N	NF	66.5	65	68	71	—	88.5	90	87	1	1	0.474
N 212	—	—	—	N	NF	68	—	—	—	—	—	102	100	1.5	1.5	0.823
NU 212 EW	NU	NJ	NUP	—	—	68	68	70	75	80	102	—	—	1.5	1.5	0.824
NU2212 ET	NU	NJ	NUP	—	—	68	68	70	75	80	102	—	—	1.5	1.5	1.06
N 312	—	—	—	N	NF	71	—	—	—	—	—	119	115	2	2	1.78
N 312	NU	NJ	NUP	—	—	71	71	75	79	86	119	—	—	2	2	1.82
NU 312 EM	NU	NJ	NUP	—	—	71	71	75	79	86	119	—	—	2	2	2.06
NU2312 ET	NU	NJ	NUP	—	—	71	71	75	79	86	119	—	—	2	2	2.7
NU 412	NU	NJ	NUP	N	NF	71	71	80	85	94	139	139	130	2	2	3.04
NU1013	NU	NJ	—	N	NF	71.5	70	73	76	—	93.5	95	92	1	1	0.504
N 213	—	—	—	N	NF	73	—	—	—	—	—	112	108	1.5	1.5	1.05
NU 213 EW	NU	NJ	NUP	—	—	73	73	76	81	87	112	—	—	1.5	1.5	1.05
NU2213 ET	NU	NJ	NUP	—	—	73	73	76	81	87	112	—	—	1.5	1.5	1.41
N 313	—	—	—	N	NF	76	—	—	—	—	—	129	125	2	2	2.17
NU 313	NU	NJ	NUP	—	—	76	76	81	85	93	129	—	—	2	2	2.23
NU 313 EM	NU	NJ	NUP	—	—	76	76	80	85	93	129	—	—	2	2	2.56
NU2313 ET	NU	NJ	NUP	—	—	76	76	80	85	93	129	—	—	2	2	3.16
NU 413	NU	NJ	—	N	NF	76	76	86	91	100	149	149	138.8	2	2	3.63
NU1014	NU	NJ	NUP	N	NF	76.5	75	79	82	—	103.5	105	101	1	1	0.693
N 214	—	—	—	N	NF	78	—	—	—	—	—	117	113	1.5	1.5	1.14
NU 214 EM	NU	NJ	NUP	—	—	78	78	81	86	92	117	—	—	1.5	1.5	1.29
NU2214 ET	NU	NJ	NUP	—	—	78	78	81	86	92	117	—	—	1.5	1.5	1.49
N 314	—	—	—	N	NF	81	—	—	—	—	—	139	133.5	2	2	2.67
NU 314	NU	NJ	NUP	—	—	81	81	87	92	100	139	—	—	2	2	2.75
NU 314 EM	NU	NJ	NUP	—	—	81	81	86	92	100	139	—	—	2	2	3.09
NU2314 ET	NU	NJ	NUP	—	—	81	81	86	92	100	139	—	—	2	2	3.92
NU 414	NU	NJ	NUP	N	NF	83	83	97	102	112	167	167	155	2.5	2.5	5.28
NU1015	NU	—	—	N	NF	81.5	80	83	87	—	108.5	110	106	1	1	0.731
N 215	—	—	—	N	NF	83	—	—	—	—	—	122	119	1.5	1.5	1.23
NU 215 EM	NU	NJ	NUP	—	—	83	83	86	90	96	122	—	—	1.5	1.5	1.44
NU2215 ET	NU	NJ	NUP	—	—	83	83	86	90	96	122	—	—	1.5	1.5	1.57
N 315	—	—	—	N	NF	86	—	—	—	—	—	149	143	2	2	3.2
NU 315	NU	NJ	NUP	—	—	86	86	93	97	106	149	—	—	2	2	3.26
NU 315 EM	NU	NJ	NUP	—	—	86	86	92	97	106	149	—	—	2	2	3.73
NU2315 ET	NU	NJ	NUP	—	—	86	86	92	97	106	149	—	—	2	2	4.86
NU 415	NU	NJ	—	N	NF	88	88	102	107	118	177	177	164	2.5	2.5	6.27

Notes ⁽¹⁾ The limiting speeds listed above apply to bearings with machined cages (No suffix). For bearings with pressed cages, reduce the limiting speed by 20%. (Not applicable to bearing numbers with an EM, EW, or ET suffix.)

⁽²⁾ The bearings with suffix ET have polyamide cage. The maximum operating temperature should be less than 120 °C.

Notes ⁽³⁾ When L-shaped thrust collars (See section for L-Shaped Thrust Collars starting on page B104) are used, the bearings become the NH type.

⁽⁴⁾ If axial loads are applied, increase d_a and reduce D_a from the values listed above.

⁽⁵⁾ d_b (max.) are values for adjusting rings for NU, NJ Types.

Bore Diameter 80 – 95 mm

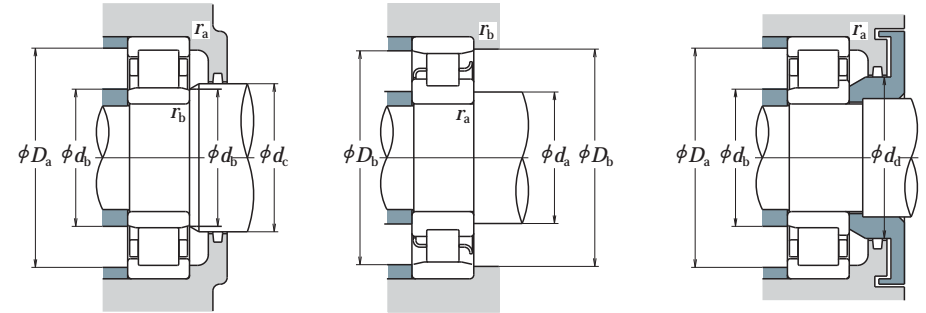
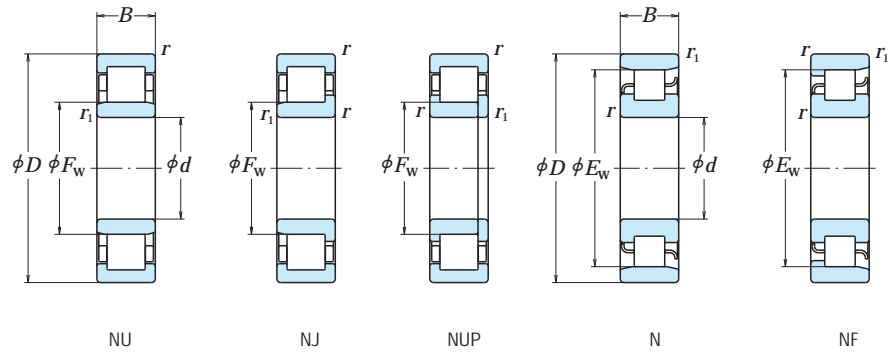

d	Boundary Dimensions (mm)						Basic Load Ratings (N)		Limiting Speeds ⁽¹⁾ (min ⁻¹)		
	D	B	r min.	r ₁ min.	F _W	E _W	C _r	C _{0r}	Grease	Oil	
80	125	22	1.1	1	91.5	113.5	72 500	90 500	5 300	6 300	
	140	26	2	2	—	125.3	106 000	122 000	4 500	5 300	
	140	26	2	2	95.3	—	139 000	167 000	4 500	5 300	
	140	33	2	2	95.3	—	186 000	243 000	4 000	5 000	
	170	39	2.1	2.1	—	147	190 000	207 000	3 600	4 300	
	170	39	2.1	2.1	101	—	256 000	282 000	3 600	4 300	
	170	58	2.1	2.1	101	—	355 000	430 000	3 200	4 000	
	200	48	3	3	110	170	299 000	315 000	3 200	3 800	
	85	130	22	1.1	1	96.5	118.5	74 500	95 500	5 000	6 000
		150	28	2	2	—	133.8	120 000	140 000	4 300	5 000
150		28	2	2	100.5	—	167 000	199 000	4 300	5 000	
150		36	2	2	100.5	—	217 000	279 000	3 800	4 500	
180		41	3	3	—	156	225 000	247 000	3 400	4 000	
180		41	3	3	108	—	212 000	228 000	3 400	4 000	
180		41	3	3	108	—	291 000	330 000	3 400	4 000	
180		60	3	3	108	—	395 000	485 000	3 000	3 800	
210		52	4	4	113	177	335 000	350 000	3 000	3 800	
90		140	24	1.5	1.1	103	127	88 000	114 000	4 500	5 600
	160	30	2	2	—	143	152 000	178 000	4 000	4 800	
	160	30	2	2	107	—	182 000	217 000	4 000	4 800	
	160	40	2	2	107	—	242 000	315 000	3 600	4 300	
	190	43	3	3	—	165	240 000	265 000	3 200	3 800	
	190	43	3	3	115	—	240 000	265 000	3 200	3 800	
	190	43	3	3	113.5	—	315 000	355 000	3 200	3 800	
	190	64	3	3	113.5	—	435 000	535 000	2 800	3 400	
	225	54	4	4	123.5	191.5	375 000	400 000	2 800	3 400	
	95	145	24	1.5	1.1	108	132	90 500	120 000	4 300	5 300
170		32	2.1	2.1	—	151.5	166 000	196 000	3 800	4 500	
170		32	2.1	2.1	112.5	—	220 000	265 000	3 800	4 500	
170		43	2.1	2.1	112.5	—	286 000	370 000	3 400	4 000	
200		45	3	3	—	173.5	259 000	289 000	3 000	3 600	
200		45	3	3	121.5	—	259 000	289 000	3 000	3 600	
200		45	3	3	121.5	—	335 000	385 000	3 000	3 600	
200		67	3	3	121.5	—	460 000	585 000	2 600	3 400	
240		55	4	4	133.5	201.5	400 000	445 000	2 600	3 200	

Bearing Numbers ⁽²⁾	Abutment and Fillet Dimensions (mm)										Mass (kg) approx.					
	NU	NJ	NUP	N	NF	d _a ⁽⁴⁾ min.	d _b min.	d _b ⁽⁵⁾ max.	d _c min.	d _d min.		D _a ⁽⁴⁾ max.	D _b max.	D _b min.	r _a max.	r _b max.
NU1016	—	—	—	—	—	86.5	85	90	94	—	118.5	120	115	1	1	0.969
N 216	—	—	—	N	NF	89	—	—	—	—	—	131	128	2	2	1.47
NU 216 EM	NU	NJ	NUP	—	—	89	89	92	97	104	131	—	—	2	2	1.7
NU2216 ET	NU	NJ	NUP	—	—	89	89	92	97	104	131	—	—	2	2	1.96
N 316	—	—	—	N	NF	91	—	—	—	—	—	159	150	2	2	3.85
NU 316 EM	NU	NJ	NUP	—	—	91	91	98	105	114	159	—	—	2	2	4.45
NU2316 ET	NU	NJ	NUP	—	—	91	91	98	105	114	159	—	—	2	2	5.73
NU 416	NU	NJ	—	N	NF	93	93	107	112	124	187	187	173	2.5	2.5	7.36
NU1017	NU	—	—	N	—	91.5	90	95	99	—	123.5	125	120	1	1	1.01
N 217	—	—	—	N	NF	94	—	—	—	—	—	141	137	2	2	1.87
NU 217 EM	NU	NJ	NUP	—	—	94	94	98	104	110	141	—	—	2	2	2.11
NU2217 ET	NU	NJ	NUP	—	—	94	94	98	104	110	141	—	—	2	2	2.44
N 317	—	—	—	N	NF	98	—	—	—	—	—	167	159	2.5	2.5	4.53
NU 317	NU	NJ	NUP	—	—	98	98	105	110	119	167	—	—	2.5	2.5	4.6
NU 317 EM	NU	NJ	NUP	—	—	98	98	105	110	119	167	—	—	2.5	2.5	5.26
NU2317 ET	NU	NJ	NUP	—	—	98	98	105	110	119	167	—	—	2.5	2.5	6.77
NU 417	NU	NJ	—	N	NF	101	101	110	115	128	194	194	180	3	3	9.56
NU1018	NU	—	—	N	—	98	96.5	101	106	—	132	133.5	129	1.5	1	1.35
N 218	—	—	—	N	NF	99	—	—	—	—	—	151	146	2	2	2.31
NU 218 EM	NU	NJ	NUP	—	—	99	99	104	109	116	151	—	—	2	2	2.6
NU2218 ET	NU	NJ	NUP	—	—	99	99	104	109	116	151	—	—	2	2	3.11
N 318	—	—	—	N	NF	103	—	—	—	—	—	177	168	2.5	2.5	5.31
NU 318	NU	NJ	NUP	—	—	103	103	112	117	127	177	—	—	2.5	2.5	5.38
NU 318 EM	NU	NJ	NUP	—	—	103	103	111	117	127	177	—	—	2.5	2.5	6.1
NU2318 ET	NU	NJ	NUP	—	—	103	103	111	117	127	177	—	—	2.5	2.5	7.9
NU 418	NU	NJ	—	N	NF	106	106	120	125	139	209	209	196	3	3	11.5
NU1019	NU	NJ	—	N	—	103	101.5	106	111	—	137	138.5	134	1.5	1	1.41
N 219	—	—	—	N	NF	106	—	—	—	—	—	159	155	2	2	2.79
NU 219 EM	NU	NJ	NUP	—	—	106	106	110	116	123	159	—	—	2	2	3.17
NU2219 ET	NU	NJ	NUP	—	—	106	106	110	116	123	159	—	—	2	2	3.81
N 319	—	—	—	N	NF	108	—	—	—	—	—	187	177	2.5	2.5	6.09
NU 319	NU	NJ	NUP	—	—	108	108	118	124	134	187	—	—	2.5	2.5	6.23
NU 319 EM	NU	NJ	NUP	—	—	108	108	118	124	134	187	—	—	2.5	2.5	7.13
NU2319 ET	NU	NJ	NUP	—	—	108	108	118	124	134	187	—	—	2.5	2.5	9.21
NU 419	NU	NJ	NUP	—	NF	111	111	130	136	149	224	224	206	3	3	13.6

Notes ⁽¹⁾ The limiting speeds listed above apply to bearings with machined cages (No suffix). For bearings with pressed cages, reduce the limiting speed by 20%. (Not applicable to bearing numbers with an EM, EW, or ET suffix.)
⁽²⁾ The bearings with suffix ET have polyamide cage. The maximum operating temperature should be less than 120 °C.

Notes ⁽³⁾ When L-shaped thrust collars (See section for L-Shaped Thrust Collars starting on page B104) are used, the bearings become the NH type.
⁽⁴⁾ If axial loads are applied, increase d_a and reduce D_a from the values listed above.
⁽⁵⁾ d_b (max.) are values for adjusting rings for NU, NJ Types.

Bore Diameter 100 – 120 mm

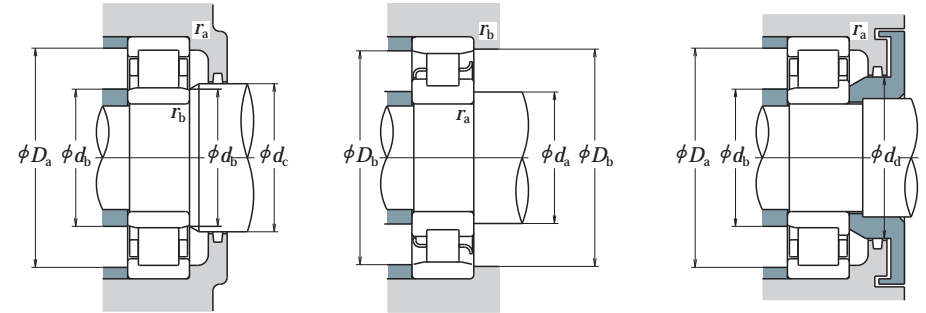
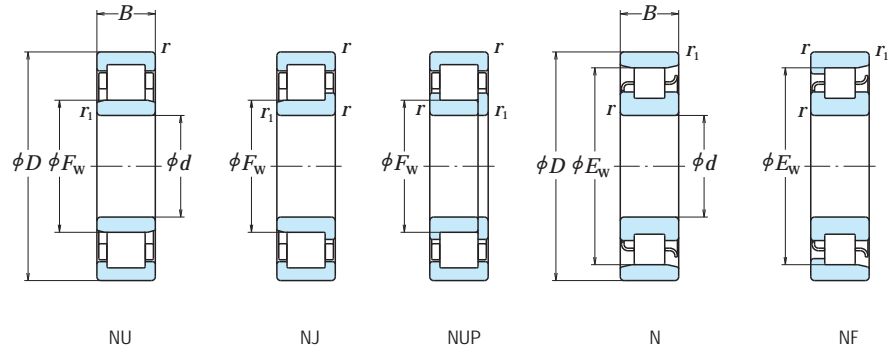

d	Boundary Dimensions (mm)						Basic Load Ratings (N)		Limiting Speeds ⁽¹⁾ (min ⁻¹)	
	D	B	r min.	r ₁ min.	F _W	E _W	C _r	C _{0r}	Grease	Oil
100	150	24	1.5	1.1	113	137	93 000	126 000	4 300	5 300
	180	34	2.1	2.1	—	160	183 000	217 000	3 600	4 300
	180	34	2.1	2.1	119	—	249 000	305 000	3 600	4 300
	180	46	2.1	2.1	119	—	335 000	445 000	3 200	3 800
	215	47	3	3	—	185.5	299 000	335 000	2 800	3 400
	215	47	3	3	129.5	—	299 000	335 000	2 800	3 400
	215	47	3	3	127.5	—	380 000	425 000	2 800	3 400
	215	73	3	3	127.5	—	570 000	715 000	2 400	3 000
	250	58	4	4	139	211	450 000	500 000	2 600	3 000
	105	160	26	2	1.1	119.5	145.5	109 000	149 000	4 000
190		36	2.1	2.1	—	168.8	201 000	241 000	3 400	4 000
190		36	2.1	2.1	125	—	262 000	310 000	3 400	4 000
225		49	3	3	—	195	340 000	390 000	2 600	3 200
225		49	3	3	133	—	425 000	480 000	2 600	3 200
260		60	4	4	144.5	220.5	495 000	555 000	2 400	3 000
110		170	28	2	1.1	125	155	131 000	174 000	3 800
	200	38	2.1	2.1	—	178.5	229 000	272 000	3 200	3 800
	200	38	2.1	2.1	132.5	—	293 000	365 000	3 200	3 800
	200	53	2.1	2.1	132.5	—	385 000	515 000	2 800	3 400
	240	50	3	3	—	207	380 000	435 000	2 600	3 000
	240	50	3	3	143	—	450 000	525 000	2 600	3 000
	280	65	4	4	155	—	550 000	620 000	2 200	2 800
	120	180	28	2	1.1	135	165	139 000	191 000	3 400
215		40	2.1	2.1	—	191.5	260 000	320 000	3 000	3 400
215		40	2.1	2.1	143.5	—	335 000	420 000	3 000	3 400
215		58	2.1	2.1	143.5	—	450 000	620 000	2 600	3 200
260		55	3	3	—	226	450 000	510 000	2 200	2 800
260		55	3	3	154	—	530 000	610 000	2 200	2 800
260		86	3	3	154	—	795 000	1 030 000	2 000	2 600
310		72	5	5	170	260	675 000	770 000	2 000	2 400

Bearing Numbers ⁽²⁾						Abutment and Fillet Dimensions (mm)										Mass (kg) approx.
⁽³⁾ NU NJ NUP N NF						d _a ⁽⁴⁾ min.	d _b min.	d _b ⁽⁵⁾ max.	d _c	d _d min.	D _a ⁽⁴⁾ max.	D _b max.	D _b min.	r _a max.	r _b max.	
NU1020	NU	NJ	NUP	N	—	108	106.5	111	116	—	142	143.5	139	1.5	1	1.47
N 220	—	—	—	N	NF	111	—	—	—	—	—	169	163	2	2	3.36
NU 220 EM	NU	NJ	NUP	—	—	111	111	116	122	130	169	—	—	2	2	3.81
NU2220 ET	NU	NJ	NUP	—	—	111	111	116	122	130	169	—	—	2	2	4.69
N 320	—	—	—	N	NF	113	—	—	—	—	—	202	190	2.5	2.5	7.59
NU 320	NU	NJ	NUP	—	—	113	113	126	132	143	202	—	—	2.5	2.5	7.69
NU 320 EM	NU	NJ	NUP	—	—	113	113	124	132	143	202	—	—	2.5	2.5	8.63
NU2320 ET	NU	NJ	NUP	—	—	113	113	124	132	143	202	—	—	2.5	2.5	11.8
NU 420	NU	NJ	—	N	NF	116	116	135	141	156	234	234	215	3	3	15.5
NU1021	NU	—	—	N	NF	114	111.5	118	122	—	151	153.5	147	2	1	1.83
N 221	—	—	—	N	NF	116	—	—	—	—	—	179	172	2	2	4.0
NU 221 EM	NU	NJ	NUP	—	—	116	116	121	129	137	179	—	—	2	2	4.58
N 321	—	—	—	N	NF	118	—	—	—	—	—	212	199	2.5	2.5	8.69
NU 321 EM	NU	NJ	NUP	—	—	118	118	131	137	149	212	—	—	2.5	2.5	9.84
NU 421	NU	NJ	—	N	NF	121	121	141	147	162	244	244	225	3	3	17.3
NU1022	NU	NJ	—	N	NF	119	116.5	123	128	—	161	163.5	157	2	1	2.27
N 222	—	—	—	N	NF	121	—	—	—	—	—	189	182	2	2	4.64
NU 222 EM	NU	NJ	NUP	—	—	121	121	129	135	144	189	—	—	2	2	5.37
NU2222 EM	NU	NJ	NUP	—	—	121	121	129	135	144	189	—	—	2	2	7.65
N 322	—	—	—	N	NF	123	—	—	—	—	—	227	211	2.5	2.5	10.3
NU 322 EM	NU	NJ	NUP	—	—	123	123	139	145	158	227	—	—	2.5	2.5	11.8
NU 422	NU	NJ	—	—	—	126	126	151	157	173	264	—	—	3	3	22.1
NU1024	NU	NJ	NUP	N	—	129	126.5	133	138	—	171	173.5	167	2	1	2.43
N 224	—	—	—	N	NF	131	—	—	—	—	—	204	196	2	2	5.63
NU 224 EM	NU	NJ	NUP	—	—	131	131	140	146	156	204	—	—	2	2	6.43
NU2224 EM	NU	NJ	NUP	—	—	131	131	140	146	156	204	—	—	2	2	9.51
N 324	—	—	—	N	NF	133	—	—	—	—	—	247	230	2.5	2.5	12.9
NU 324 EM	NU	NJ	NUP	—	—	133	133	150	156	171	247	—	—	2.5	2.5	15
NU2324 EM	NU	NJ	NUP	—	—	133	133	150	156	171	247	—	—	2.5	2.5	25
NU 424	NU	NJ	NUP	N	—	140	140	166	172	190	290	290	266	4	4	30.2

Notes ⁽¹⁾ The limiting speeds listed above apply to bearings with machined cages (No suffix). For bearings with pressed cages, reduce the limiting speed by 20%. (Not applicable to bearing numbers with an EM, EW, or ET suffix.)
⁽²⁾ The bearings with suffix ET have polyamide cage. The maximum operating temperature should be less than 120 °C.

Notes ⁽³⁾ When L-shaped thrust collars (See section for L-Shaped Thrust Collars starting on page B104) are used, the bearings become the NH type.
⁽⁴⁾ If axial loads are applied, increase d_a and reduce D_a from the values listed above.
⁽⁵⁾ d_b (max.) are values for adjusting rings for NU, NJ Types.

Bore Diameter 130 – 160 mm

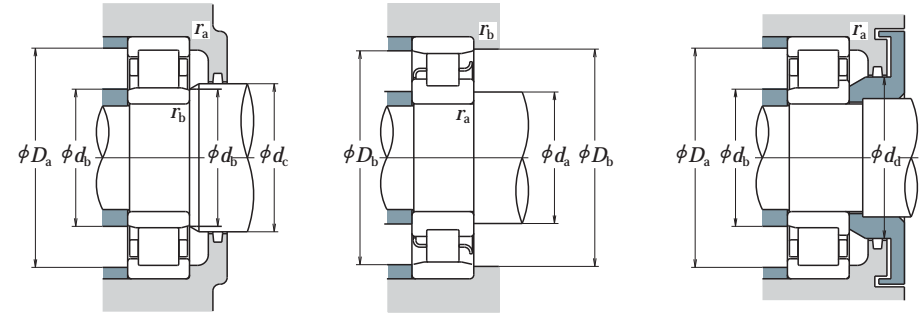
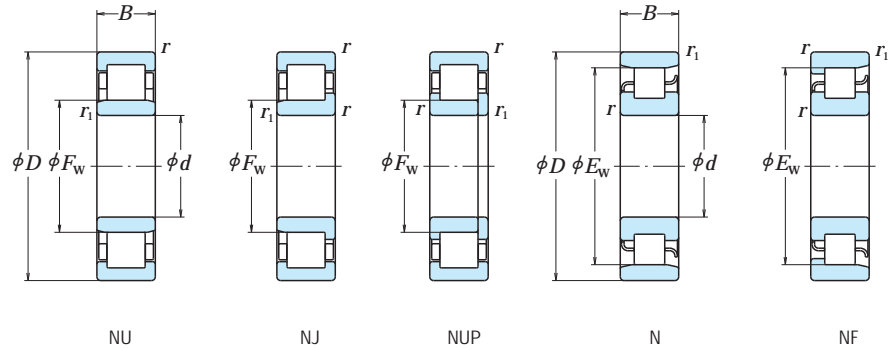

d	Boundary Dimensions (mm)						Basic Load Ratings (N)		Limiting Speeds ⁽¹⁾ (min ⁻¹)	
	D	B	r min.	r ₁ min.	F _W	E _W	C _r	C _{0r}	Grease	Oil
130	200	33	2	1.1	148	182	172 000	238 000	3 200	3 800
	230	40	3	3	—	204	270 000	340 000	2 600	3 200
	230	40	3	3	153.5	—	365 000	455 000	2 600	3 200
	230	64	3	3	153.5	—	530 000	735 000	2 400	3 000
	280	58	4	4	—	243	500 000	570 000	2 200	2 600
	280	58	4	4	167	—	615 000	735 000	2 200	2 600
	280	93	4	4	167	—	920 000	1 230 000	1 900	2 400
	340	78	5	5	185	285	825 000	955 000	1 800	2 200
140	210	33	2	1.1	158	192	176 000	250 000	3 000	3 600
	250	42	3	3	—	221	297 000	375 000	2 400	3 000
	250	42	3	3	169	—	395 000	515 000	2 400	3 000
	250	68	3	3	169	—	550 000	790 000	2 200	2 800
	300	62	4	4	—	260	550 000	640 000	2 000	2 400
	300	62	4	4	180	—	665 000	795 000	2 000	2 400
	300	102	4	4	180	—	1 020 000	1 380 000	1 700	2 200
	360	82	5	5	198	302	875 000	1 020 000	1 700	2 000
150	225	35	2.1	1.5	169.5	205.5	202 000	294 000	2 800	3 400
	270	45	3	3	—	238	360 000	465 000	2 200	2 800
	270	45	3	3	182	—	450 000	595 000	2 200	2 800
	270	73	3	3	182	—	635 000	930 000	2 000	2 600
	320	65	4	4	—	277	665 000	805 000	1 800	2 200
	320	65	4	4	193	—	760 000	920 000	1 800	2 200
	320	108	4	4	193	—	1 160 000	1 600 000	1 600	2 000
	380	85	5	5	213	—	930 000	1 120 000	1 600	2 000
160	240	38	2.1	1.5	180	220	238 000	340 000	2 600	3 200
	290	48	3	3	—	255	430 000	570 000	2 200	2 600
	290	48	3	3	195	—	500 000	665 000	2 200	2 600
	290	80	3	3	193	—	810 000	1 190 000	1 900	2 400
	340	68	4	4	—	292	700 000	875 000	1 700	2 000
	340	68	4	4	204	—	860 000	1 050 000	1 700	2 000
	340	114	4	4	204	—	1 310 000	1 820 000	1 500	1 900

Bearing Numbers ⁽²⁾						Abutment and Fillet Dimensions (mm)										Mass (kg) approx.
⁽³⁾ NU NJ NUP N NF						d _a ⁽⁴⁾ min.	d _b min.	d _b ⁽⁵⁾ max.	d _c	d _d min.	D _a ⁽⁴⁾ max.	D _b max.	D _b min.	r _a max.	r _b max.	
NU1026	NU	NJ	—	N	NF	139	136.5	146	151	—	191	193.5	184	2	1	3.66
N 226	—	—	—	N	NF	143	—	—	—	—	—	217	208	2.5	2.5	6.48
NU 226 EM	NU	NJ	NUP	—	—	143	143	150	158	168	217	—	—	2.5	2.5	8.03
NU2226 EM	NU	NJ	NUP	—	—	143	143	150	158	168	217	—	—	2.5	2.5	9.44
N 326	—	—	—	N	NF	146	—	—	—	—	—	264	247.5	3	3	17.7
NU326EM	NU	NJ	NUP	—	—	146	146	163	169	184	264	—	—	3	3	18.7
NU2326EM	NU	NJ	NUP	—	—	146	146	163	169	184	264	—	—	3	3	30
NU 426	NU	NJ	—	NF	—	150	150	180	187	208	320	320	291	4	4	39.6
NU1028	NU	NJ	NUP	N	—	149	146.5	156	161	—	201	203.5	194	2	1	3.87
N 228	—	—	—	N	NF	153	—	—	—	—	—	237	225	2.5	2.5	8.08
NU228EM	NU	NJ	NUP	—	—	153	153	165	171	182	237	—	—	2.5	2.5	9.38
NU2228EM	NU	NJ	NUP	—	—	153	153	165	171	182	237	—	—	2.5	2.5	15.2
N 328	—	—	—	N	NF	156	—	—	—	—	—	284	266	3	3	21.7
NU328EM	NU	NJ	NUP	—	—	156	156	176	182	198	284	—	—	3	3	22.8
NU2328EM	NU	NJ	NUP	—	—	156	156	176	182	198	284	—	—	3	3	37.7
NU 428	NU	NJ	—	N	—	160	160	193	200	222	340	340	308	4	4	46.4
NU1030	NU	NJ	—	N	NF	161	158	167	173	—	214	217	208	2	1.5	4.77
N 230	—	—	—	N	NF	163	—	—	—	—	—	257	242	2.5	2.5	10.4
NU230EM	NU	NJ	NUP	—	—	163	163	177	184	196	257	—	—	2.5	2.5	11.9
NU2230EM	NU	NJ	NUP	—	—	163	163	177	184	196	257	—	—	2.5	2.5	19.3
N 330	—	—	—	N	NF	166	—	—	—	—	—	304	283	3	3	25.8
NU330EM	NU	NJ	NUP	—	—	166	166	188	195	213	304	—	—	3	3	27.1
NU2330EM	NU	NJ	NUP	—	—	166	166	188	195	213	304	—	—	3	3	45.1
NU 430	NU	NJ	—	—	—	170	170	208	216	237	360	—	—	4	4	55.8
NU1032	NU	NJ	—	N	NF	171	168	178	184	—	229	232	222	2	1.5	5.81
N 232	—	—	—	N	NF	173	—	—	—	—	—	277	261	2.5	2.5	14.1
NU232EM	NU	NJ	NUP	—	—	173	173	190	197	210	277	—	—	2.5	2.5	14.7
NU2232EM	NU	NJ	NUP	—	—	173	173	188	197	210	277	—	—	2.5	2.5	24.5
N 332	—	—	—	N	—	176	—	—	—	—	—	324	298	3	3	30.8
NU332EM	NU	NJ	NUP	—	—	176	176	199	211	228	324	—	—	3	3	32.1
NU2332EM	NU	NJ	NUP	—	—	176	176	199	211	228	324	—	—	3	3	53.9

Notes ⁽¹⁾ The limiting speeds listed above apply to bearings with machined cages (No suffix). For bearings with pressed cages, reduce the limiting speed by 20%. (Not applicable to bearing numbers with an EM, EW, or ET suffix.)
⁽²⁾ The bearings with suffix ET have polyamide cage. The maximum operating temperature should be less than 120 °C.

Notes ⁽³⁾ When L-shaped thrust collars (See section for L-Shaped Thrust Collars starting on page B104) are used, the bearings become the NH type.
⁽⁴⁾ If axial loads are applied, increase d_a and reduce D_a from the values listed above.
⁽⁵⁾ d_b (max.) are values for adjusting rings for NU, NJ Types.

Bore Diameter 170 – 220 mm

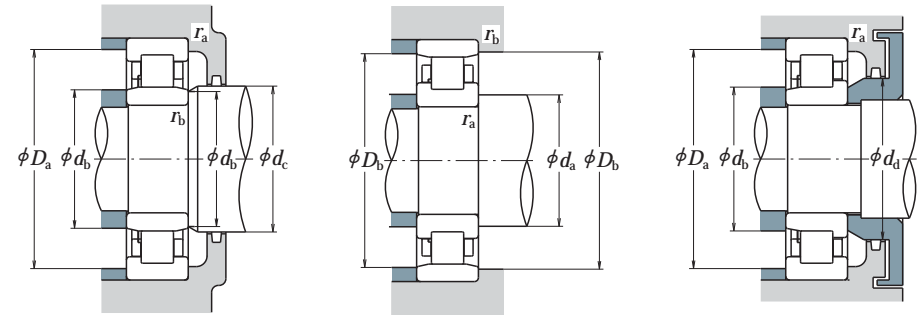
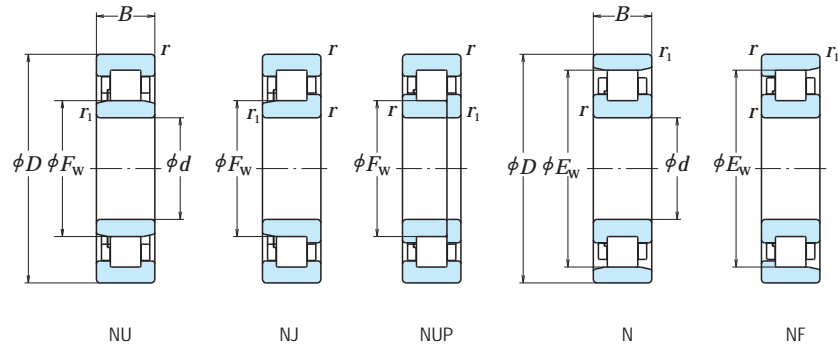

d	Boundary Dimensions (mm)						Basic Load Ratings (N)		Limiting Speeds (min ⁻¹)	
	D	B	r min.	r ₁ min.	F _w	E _w	C _r	C _{0r}	Grease	Oil
170	260	42	2.1	2.1	193	237	287 000	415 000	2 400	2 800
	310	52	4	4	—	272	475 000	635 000	2 000	2 400
	310	52	4	4	207	—	605 000	800 000	2 000	2 400
	310	86	4	4	205	—	925 000	1 330 000	1 800	2 200
	360	72	4	4	—	310	795 000	1 010 000	1 600	2 000
	360	72	4	4	218	—	930 000	1 150 000	1 600	2 000
180	360	120	4	4	216	—	1 490 000	2 070 000	1 400	1 800
	280	46	2.1	2.1	205	255	355 000	510 000	2 200	2 600
	320	52	4	4	—	282	495 000	675 000	1 900	2 200
	320	52	4	4	217	—	625 000	850 000	1 900	2 200
	320	86	4	4	215	—	1 010 000	1 510 000	1 700	2 000
	380	75	4	4	—	328	905 000	1 150 000	1 500	1 800
190	380	75	4	4	231	—	985 000	1 230 000	1 500	1 800
	380	126	4	4	227	—	1 560 000	2 220 000	1 300	1 700
	290	46	2.1	2.1	215	265	365 000	535 000	2 000	2 600
	340	55	4	4	—	299	555 000	770 000	1 800	2 200
	340	55	4	4	230	—	695 000	955 000	1 800	2 200
	340	92	4	4	228	—	1 100 000	1 670 000	1 600	2 000
200	400	78	5	5	—	345	975 000	1 260 000	1 400	1 700
	400	78	5	5	245	—	1 060 000	1 340 000	1 400	1 700
	400	132	5	5	240	—	1 770 000	2 520 000	1 300	1 600
	310	51	2.1	2.1	229	281	390 000	580 000	2 000	2 400
	360	58	4	4	—	316	620 000	865 000	1 700	2 000
	360	58	4	4	243	—	765 000	1 060 000	1 700	2 000
220	360	98	4	4	241	—	1 220 000	1 870 000	1 500	1 800
	420	80	5	5	—	360	975 000	1 270 000	1 300	1 600
	420	80	5	5	258	—	1 140 000	1 450 000	1 300	1 600
	420	138	5	5	253	—	1 910 000	2 760 000	1 200	1 500
	340	56	3	3	250	310	500 000	750 000	1 800	2 200
	400	65	4	4	—	350	760 000	1 080 000	1 500	1 800
220	400	65	4	4	270	—	760 000	1 080 000	1 500	1 800
	400	108	4	4	270	—	1 140 000	1 810 000	1 300	1 600
	460	88	5	5	—	396	1 190 000	1 570 000	1 200	1 500
	460	88	5	5	284	—	1 190 000	1 570 000	1 200	1 500

Bearing Numbers	Abutment and Fillet Dimensions (mm)										Mass (kg)					
	NU	NJ	NUP	N	NF	d _a ⁽²⁾ min.	d _b min.	d _b ⁽³⁾ max.	d _c	d _d min.		D _a ⁽²⁾ max.	D _b max.	D _b min.	r _a max.	r _b
NU1034	NU	NJ	—	N	—	181	181	190	197	—	249	249	239	2	2	7.91
N 234	—	—	—	N	NF	186	—	—	—	—	—	294	278	3	3	17.4
NU234EM	NU	NJ	NUP	—	—	186	186	202	211	223	294	—	—	3	3	18.3
NU2234EM	NU	NJ	NUP	—	—	186	186	200	211	223	294	—	—	3	3	29.9
N 334	—	—	—	N	—	186	—	—	—	—	—	344	316	3	3	36.6
NU334EM	NU	NJ	NUP	—	—	186	186	213	223	241	344	—	—	3	3	37.9
NU2334EM	NU	NJ	NUP	—	—	186	186	210	223	241	344	—	—	3	3	63.4
NU1036	NU	NJ	—	N	NF	191	191	202	209	—	269	269	258	2	2	10.2
N 236	—	—	—	N	NF	196	—	—	—	—	—	304	288	3	3	18.1
NU236EM	NU	NJ	NUP	—	—	196	196	212	221	233	304	—	—	3	3	19
NU2236EM	NU	NJ	NUP	—	—	196	196	210	221	233	304	—	—	3	3	31.4
N 336	—	—	—	N	NF	196	—	—	—	—	—	364	335	3	3	42.6
NU336EM	NU	NJ	NUP	—	—	196	196	226	235	255	364	—	—	3	3	44
NU2336EM	NU	NJ	NUP	—	—	196	196	222	235	255	364	—	—	3	3	74.6
NU1038	NU	NJ	—	N	—	201	201	212	219	—	279	279	268	2	2	10.7
N 238	—	—	—	N	NF	206	—	—	—	—	—	324	305	3	3	22
NU238EM	NU	NJ	NUP	—	—	206	206	225	234	247	324	—	—	3	3	23
NU2238EM	NU	NJ	NUP	—	—	206	206	223	234	247	324	—	—	3	3	38.3
N 338	—	—	—	N	—	210	—	—	—	—	—	380	352	4	4	48.7
NU338EM	NU	NJ	NUP	—	—	210	210	240	248	268	380	—	—	4	4	50.6
NU2338EM	NU	NJ	NUP	—	—	210	210	235	248	268	380	—	—	4	4	86.2
NU1040	NU	NJ	—	N	NF	211	211	226	233	—	299	299	284	2	2	14
N 240	—	—	—	N	NF	216	—	—	—	—	—	344	323	3	3	26.2
NU240EM	NU	NJ	NUP	—	—	216	216	238	247	261	344	—	—	3	3	27.4
NU2240EM	NU	NJ	NUP	—	—	216	216	235	247	261	344	—	—	3	3	46.1
N 340	—	—	—	N	NF	220	—	—	—	—	—	400	367	4	4	55.3
NU340EM	NU	NJ	NUP	—	—	220	220	252	263	283	400	—	—	4	4	57.1
NU2340EM	NU	NJ	NUP	—	—	220	220	247	263	283	400	—	—	4	4	99.3
NU1044	NU	NJ	—	N	—	233	233	247	254	—	327	327	313	2.5	2.5	18.2
N 244	—	—	—	N	NF	236	—	—	—	—	—	384	357	3	3	37
NU244	NU	NJ	NUP	—	—	236	236	264	273	289	384	—	—	3	3	37.3
NU2244	NU	—	—	—	—	—	236	264	273	289	384	—	—	3	3	61.8
N 344	—	—	—	N	—	240	—	—	—	—	—	440	403	4	4	72.8
NU344	NU	NJ	—	—	—	240	240	278	287	307	440	—	—	4	4	74.6

Notes (1) When L-shaped thrust collars (Refer to page B105) are used, the bearings become the NH Type.
 (2) If axial loads are applied, increase d_a and reduce D_a from the values listed above.
 (3) d_b (max.) are values for adjusting rings for NU, NJ Types.

Bore Diameter 240 – 500 mm

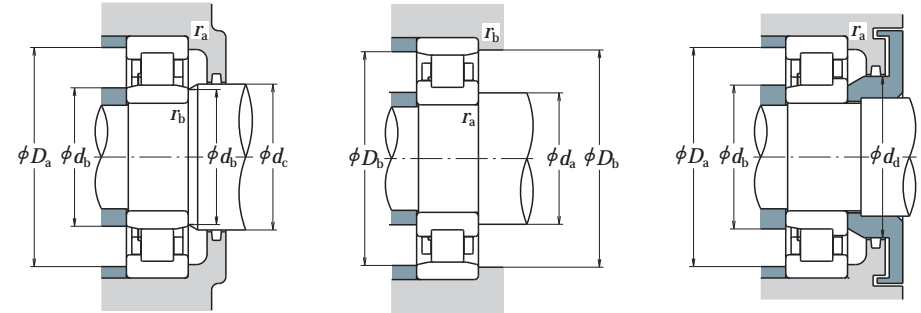
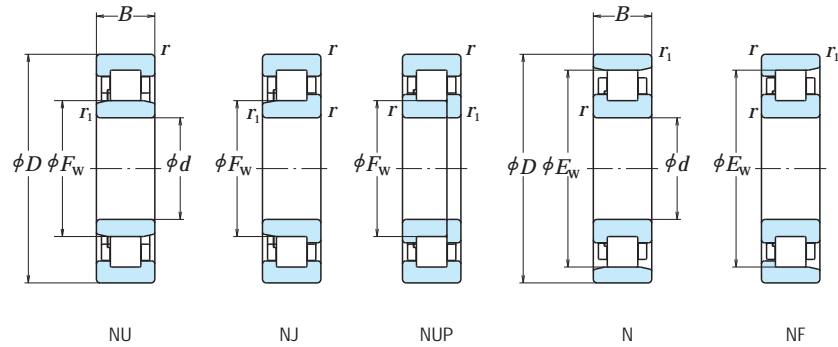

d	Boundary Dimensions (mm)						Basic Load Ratings (N)		Limiting Speeds (min ⁻¹)	
	D	B	r _{min.}	r _{1 min.}	F _w	E _w	C _r	C _{0r}	Grease	Oil
240	360	56	3	3	270	330	530 000	820 000	1 600	2 000
	440	72	4	4	—	385	935 000	1 340 000	1 300	1 600
	440	72	4	4	295	—	935 000	1 340 000	1 300	1 600
	440	120	4	4	295	—	1 440 000	2 320 000	1 200	1 500
	500	95	5	5	—	430	1 360 000	1 820 000	1 100	1 300
260	400	65	4	4	296	364	645 000	1 000 000	1 500	1 800
	480	80	5	5	—	420	1 100 000	1 580 000	1 200	1 500
	480	80	5	5	320	—	1 100 000	1 580 000	1 200	1 500
	480	130	5	5	320	—	1 710 000	2 770 000	1 100	1 300
	540	102	6	6	336	—	1 540 000	2 090 000	1 000	1 200
280	420	65	4	4	316	384	660 000	1 050 000	1 400	1 700
	500	80	5	5	—	440	1 140 000	1 680 000	1 100	1 400
	500	80	5	5	340	—	1 140 000	1 680 000	1 100	1 400
300	460	74	4	4	340	420	885 000	1 400 000	1 300	1 500
	540	85	5	5	364	—	1 400 000	2 070 000	1 100	1 300
320	480	74	4	4	360	440	905 000	1 470 000	1 200	1 400
	580	92	5	5	—	510	1 540 000	2 270 000	950	1 200
	580	92	5	5	390	—	1 540 000	2 270 000	950	1 200
340	520	82	5	5	385	475	1 080 000	1 740 000	1 100	1 300
360	540	82	5	5	405	495	1 110 000	1 830 000	1 000	1 300
380	560	82	5	5	425	—	1 140 000	1 910 000	1 000	1 200
400	600	90	5	5	450	550	1 360 000	2 280 000	900	1 100
420	620	90	5	5	470	570	1 390 000	2 380 000	850	1 100
440	650	94	6	6	493	—	1 470 000	2 530 000	800	1 000
460	680	100	6	6	516	624	1 580 000	2 740 000	750	950
480	700	100	6	6	536	644	1 620 000	2 860 000	750	900
500	720	100	6	6	556	664	1 660 000	2 970 000	710	850

Bearing Numbers	Abutment and Fillet Dimensions (mm)										Mass (kg)					
	(1)					d _a (2) min.	d _b min.	d _b (3) max.	d _c min.	d _d min.		D _a (2) max.	D _b max.	D _b min.	r _a max.	r _b max.
NU	NJ	NUP	N	NF												
NU1048	NU	NJ	—	N	—	253	253	266	275	—	347	347	333	2.5	2.5	19.5
N 248	—	—	—	N	NF	256	—	—	—	—	—	424	392	3	3	49.6
NU 248	NU	NJ	NUP	—	—	256	256	289	298	316	424	—	—	3	3	50.4
NU2248	NU	—	—	—	—	—	256	289	298	316	424	—	—	3	3	84.9
N 348	—	—	—	N	—	260	—	—	—	—	—	480	438	4	4	92.3
NU 348	NU	NJ	—	—	—	260	260	304	313	333	480	—	—	4	4	94.6
NU1052	NU	NJ	—	N	NF	276	276	292	300	—	384	384	367	3	3	29.1
N 252	—	—	—	N	—	280	—	—	—	—	—	460	428	4	4	66.2
NU 252	NU	NJ	—	—	—	280	280	314	323	343	460	—	—	4	4	67.1
NU2252	NU	—	NUP	—	—	280	280	314	323	343	460	—	—	4	4	111
NU 352	NU	NJ	—	—	—	286	286	330	339	359	514	—	—	5	5	118
NU1056	NU	NJ	NUP	N	NF	296	296	312	320	—	404	404	387	3	3	30.8
N 256	—	—	—	N	NF	300	—	—	—	—	—	480	448	4	4	69.6
NU 256	NU	NJ	—	—	—	300	300	334	344	364	480	—	—	4	4	70.7
NU1060	NU	NJ	—	N	NF	316	316	336	344	—	444	444	424	3	3	43.7
NU 260	NU	NJ	—	—	—	320	320	358	368	391	520	—	—	4	4	89.2
NU1064	NU	—	—	N	NF	336	336	356	365	—	464	464	444	3	3	46.1
N 264	—	—	—	N	—	340	—	—	—	—	—	560	519	4	4	110
NU 264	NU	NJ	—	—	—	340	340	384	394	420	560	—	—	4	4	112
NU1068	NU	NJ	—	N	NF	360	360	381	390	—	500	500	479	4	4	61.8
NU1072	NU	—	—	N	NF	380	380	400	410	—	520	520	499	4	4	64.6
NU1076	NU	—	—	—	—	—	400	420	430	—	540	—	—	4	4	67.5
NU1080	NU	—	NUP	N	—	420	420	445	455	—	580	580	554.5	4	4	88.2
NU1084	NU	—	—	N	—	440	440	465	475	—	600	600	574.5	4	4	91.7
NU1088	NU	—	—	—	—	—	466	488	498	—	624	—	—	5	5	105
NU1092	NU	—	NUP	N	—	486	486	511	521	—	654	654	628.5	5	5	123
NU1096	NU	NJ	—	N	—	506	506	531	541	—	674	674	654	5	5	127
NU10/500	NU	—	—	N	—	526	526	551	558	—	694	694	674	5	5	131

Notes (1) When L-shaped thrust collars (Refer to page B105) are used, the bearings become the NH Type.
 (2) If axial loads are applied, increase d_a and reduce D_a from the values listed above.
 (3) d_b (max.) are values for adjusting rings for NU, NJ Types.

L-Shaped Thrust Collars
Bore Diameter 20 – 85 mm

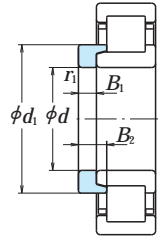

L-Shaped Thrust Collar

Bore Diameter 90 – 320 mm

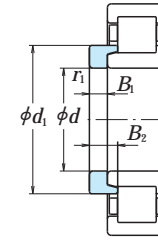

L-Shaped Thrust Collar

d	Boundary Dimensions (mm)				Bearing Numbers	Mass (kg) approx.	
	d ₁	B ₁	B ₂	r ₁ min.			
20	30	3	6.75	0.6	HJ 204	0.012	
	29.8	3	5.5	0.6	HJ 204 E	0.011	
	30	3	7.5	0.6	HJ 2204	0.012	
25	29.8	3	6.5	0.6	HJ 2204 E	0.012	
	31.7	4	7.5	0.6	HJ 304	0.017	
	31.4	4	6.5	0.6	HJ 304 E	0.017	
	31.8	4	8.5	0.6	HJ 2304	0.017	
	31.4	4	7.5	0.6	HJ 2304 E	0.018	
30	34.8	3	6	0.6	HJ 205 E	0.014	
	34.8	3	6.5	0.6	HJ 2205 E	0.014	
	38.2	4	7	1.1	HJ 305 E	0.025	
	38.2	4	8	1.1	HJ 2305 E	0.026	
35	43.6	6	10.5	1.5	HJ 405	0.057	
	41.3	4	7	0.6	HJ 206 E	0.025	
	41.4	4	7.5	0.6	HJ 2206 E	0.025	
40	45.1	5	8.5	1.1	HJ 306 E	0.042	
	45.1	5	9.5	1.1	HJ 2306 E	0.043	
	50.5	7	11.5	1.5	HJ 406	0.080	
	48.2	4	7	0.6	HJ 207 E	0.033	
	48.2	4	8.5	0.6	HJ 2207 E	0.035	
45	51.1	6	9.5	1.1	HJ 307 E	0.060	
	51.1	6	11	1.1	HJ 2307 E	0.062	
	59	8	13	1.5	HJ 407	0.12	
	54.1	5	8.5	1.1	HJ 208 E	0.049	
50	54.1	5	9	1.1	HJ 2208 E	0.050	
	57.6	7	11	1.5	HJ 308 E	0.088	
	57.7	7	12.5	1.5	HJ 2308 E	0.091	
	64.8	8	13	2	HJ 408	0.14	
	59.1	5	8.5	1.1	HJ 209 E	0.055	
55	59.1	5	9	1.1	HJ 2209 E	0.055	
	64.5	7	11.5	1.5	HJ 309 E	0.11	
	64.5	7	13	1.5	HJ 2309 E	0.113	
	71.7	8	13.5	2	HJ 409	0.175	
	64.1	5	9	1.1	HJ 210 E	0.061	
60	64.1	5	9	1.1	HJ 2210 E	0.061	
	71.4	8	13	2	HJ 310 E	0.151	
	71.4	8	14.5	2	HJ 2310 E	0.155	
	78.8	9	14.5	2.1	HJ 410	0.23	
	70.9	6	9.5	1.1	HJ 211 E	0.087	
65	70.9	6	10	1.1	HJ 2211 E	0.088	
	77.6	9	14	2	HJ 311 E	0.195	
	77.6	9	15.5	2	HJ 2311 E	0.20	
	85.2	10	16.5	2.1	HJ 411	0.29	
	77.7	6	10	1.5	HJ 212 E	0.108	
70	77.7	6	10	1.5	HJ 2212 E	0.108	
	84.5	9	14.5	2.1	HJ 312 E	0.231	
	84.5	9	16	2.1	HJ 2312 E	0.237	
	91.8	10	16.5	2.1	HJ 412	0.34	
	84.5	6	10	1.5	HJ 213 E	0.129	
75	84.5	6	10.5	1.5	HJ 2213 E	0.131	
	90.6	10	15.5	2.1	HJ 313 E	0.288	
	90.6	10	18	2.1	HJ 2313 E	0.298	
	98.5	11	18	2.1	HJ 413	0.42	
	89.5	7	11	1.5	HJ 214 E	0.157	
80	89.5	7	11.5	1.5	HJ 2214 E	0.158	
	97.5	10	15.5	2.1	HJ 314 E	0.33	
	97.5	10	18.5	2.1	HJ 2314 E	0.345	
	110.5	12	20	3	HJ 414	0.605	
	94.5	7	11	1.5	HJ 215 E	0.166	
85	94.5	7	11.5	1.5	HJ 2215 E	0.167	
	104.2	11	16.5	2.1	HJ 315 E	0.41	
	104.2	11	19.5	2.1	HJ 2315 E	0.43	
	116	13	21.5	3	HJ 415	0.71	
	101.6	8	12.5	2	HJ 216 E	0.222	
90	101.6	8	12.5	2	HJ 2216 E	0.222	
	110.6	11	17	2.1	HJ 316 E	0.46	
	110.6	11	20	2.1	HJ 2316 E	0.48	
	122	13	22	3	HJ 416	0.78	
	107.6	8	12.5	2	HJ 217 E	0.25	
95	107.6	8	13	2	HJ 2217 E	0.252	
	117.9	12	18.5	3	HJ 317 E	0.575	
	117.9	12	22	3	HJ 2317 E	0.595	
	126	14	24	4	HJ 417	0.88	
	114.3	9	14	2	HJ 218 E	0.32	
100	114.3	9	15	2	HJ 2218 E	0.325	
	124.2	12	18.5	3	HJ 318 E	0.63	
	124.2	12	22	3	HJ 2318 E	0.66	
	137	14	24	4	HJ 418	1.05	
	120.6	9	14	2.1	HJ 219 E	0.355	
105	120.6	9	15.5	2.1	HJ 2219 E	0.365	
	132.2	13	20.5	3	HJ 319 E	0.785	
	132.2	13	24.5	3	HJ 2319 E	0.815	
	147	15	25.5	4	HJ 419	1.3	
	127.5	10	15	2.1	HJ 220 E	0.44	
110	127.5	10	16	2.1	HJ 2220 E	0.45	
	139.6	13	20.5	3	HJ 320 E	0.89	
	139.6	13	23.5	3	HJ 2320 E	0.92	
	153.5	16	27	4	HJ 420	1.5	
	145	13	20.5	3	HJ 321 E	0.97	
115	145	13	20.5	3	HJ 2321 E	0.97	
	159.5	16	27	4	HJ 421	1.65	
	141.7	11	17	2.1	HJ 222 E	0.62	
	141.7	11	19.5	2.1	HJ 2222 E	0.645	
	155.8	14	22	3	HJ 322 E	1.21	
120	155.8	14	26.5	3	HJ 2322 E	1.27	
	171	17	29.5	4	HJ 422	2.1	
	153.4	11	17	2.1	HJ 224 E	0.71	
	153.4	11	20	2.1	HJ 2224 E	0.745	
	168.6	14	22.5	3	HJ 324 E	1.41	
125	168.6	14	26	3	HJ 2324 E	1.46	
	188	17	30.5	5	HJ 424	2.6	
	164.2	11	17	3	HJ 226 E	0.79	
	164.2	11	21	3	HJ 2226 E	0.84	
	182.3	14	23	4	HJ 326 E	1.65	
130	182.3	14	28	4	HJ 2326 E	1.73	
	205	18	32	5	HJ 426	3.3	
	180	11	18	3	HJ 228 E	0.99	
	180	11	23	3	HJ 2228 E	1.07	
	196	15	25	4	HJ 328 E	2.04	
135	196	15	31	4	HJ 2328 E	2.14	
	219	18	33	5	HJ 428	3.75	
	193.7	12	19.5	3	HJ 230 E	1.26	
	140	193.7	12	24.5	3	HJ 2230 E	1.35
		210	15	25	4	HJ 330 E	2.35
210		15	31.5	4	HJ 2330 E	2.48	
234		20	36.5	5	HJ 430	4.7	
207.3		12	20	3	HJ 232 E	1.48	
145	207.3	12	24.5	3	HJ 2232 E	1.55	
	222	15	25	4	HJ 332 E	2.59	
	222.1	15	32	4	HJ 2332 E	2.76	
	220.8	12	20	4	HJ 234 E	1.7	
	219.5	12	24	4	HJ 2234 E	1.79	
150	238	16	33.5	4	HJ 2334 E	3.25	
	230.8	12	20	4	HJ 236 E	1.79	
	229.5	12	24	4	HJ 2236 E	1.88	
	252	17	35	4	HJ 336 E	3.85	
	244.5	13	21.5	4	HJ 238 E	2.19	
155	244.5	13	26.5	4	HJ 2238 E	2.31	
	260.6	18	36.5	5	HJ 2338 E	4.45	
	258.2	14	23	4	HJ 240 E	2.65	
	258	14	34	4	HJ 2240	2.6	
	256.9	14	28	4	HJ 2240 E	2.78	
160	280	18	30	5	HJ 340 E	5.0	
	286	15	27.5	4	HJ 244	3.55	
	286	15	36.5	4	HJ 2244	3.55	
	307	20	36	5	HJ 344	7.05	
	313	16	29.5	4	HJ 248	4.65	
165	313	16	38.5	4	HJ 2248	4.65	
	334	22	39.5	5	HJ 348	8.2	
	340	18	33	5	HJ 252	6.2	
	340	18	40.5	5	HJ 2252	6.2	
	362	24	43	6	HJ 352	11.4	
170	360	18	33	5	HJ 256	7.4	
	387	20	34.5	5	HJ 260	9.15	
	415	21	37	5	HJ 264	11.3	

d	Boundary Dimensions (mm)				Bearing Numbers	Mass (kg) approx.
	d ₁	B ₁	B ₂	r ₁ min.		
20	30	3	6.75	0.6	HJ 204	0.012
	29.8	3	5.5	0.6	HJ 204 E	0.011
	30	3	7.5	0.6	HJ 2204	0.012
25	29.8	3	6.5	0.6	HJ 2204 E	0.012
	31.7	4	7.5	0.6	HJ 304	0.017
	31.4	4	6.5	0.6	HJ 304 E	0.017
	31.8	4	8.5	0.6	HJ 2304	0.017
	31.4	4	7.5	0.6	HJ 2304 E	0.018
30	34.8	3	6	0.6	HJ 205 E	0.014
	34.8	3	6.5	0.6	HJ 2205 E	0.014
	38.2	4	7	1.1	HJ 305 E	0.025
	38.2	4	8	1.1	HJ 2305 E	0.026
35	43.6	6	10.5	1.5	HJ 405	0.057
	41.3	4	7	0.6	HJ 206 E	0.025
	41.4	4	7.5	0.6	HJ 2206 E	0.025
40	45.1	5	8.5	1.1	HJ 306 E	0.042
	45.1	5	9.5	1.1	HJ 2306 E	0.043
	50.5	7	11.5	1.5	HJ 406	0.080
	48.2	4	7	0.6	HJ 207 E	0.033
	48.2	4	8.5	0.6	HJ 2207 E	0.035
45	51.1	6	9.5	1.1	HJ 307 E	0.060
	51.1	6	11	1.1	HJ 2307 E	0.062
	59	8	13	1.5	HJ 407	0.12
	54.1	5	8.5	1.1	HJ 208 E	0.049
50	54.1	5	9	1.1	HJ 2208 E	0.050
	57.6	7	11	1.5	HJ 308 E	0.088
	57.7	7	12.5	1.5	HJ 2308 E	0.091
	64.8	8	13	2	HJ 408	0.14
	59.1	5	8.5	1.1	HJ 209 E	0.055
55	59.1	5	9	1.1	HJ 2209 E	0.055
	64.5	7	11.5	1.5	HJ 309 E	0.11
	64.5	7	13	1.5	HJ 2309 E	0.113
	71.7	8	13.5	2	HJ 409	0.175
	64.1	5	9	1.1	HJ 210 E	0.061
60	64.1	5	9	1.1	HJ 2210 E	0.061
	71.4	8	13	2	HJ 310 E	0.151
	71.4	8	14.5	2	HJ 2310 E	0.155
	78.8	9	14.5	2.1	HJ 410	0.23
	70.9	6	9.5	1.1	HJ 211 E	0.087
65	70.9	6	10	1.1	HJ 2211 E	0.088
	77.6	9	14	2	HJ 311 E	0.195
	77.6	9	15.5	2	HJ 2311 E	0.20
	85.2	10	16.5	2.1	HJ 411	0.29
	77.7	6	10	1.5	HJ 212 E	0.108
70	77.7	6	10	1.5	HJ 2212 E	0.108
	84.5	9	14.5	2.1	HJ 312 E	0.231
	84.5	9	16	2.1	HJ 2312 E	0.237
	91.8	10	16.5	2.1	HJ 412	0.34
	84.5	6	10	1.5	HJ 213 E	0.129
75	84.5	6	10.5	1.5	HJ 2213 E	0.131
	90.6	10	15.5	2.1	HJ 313 E	0.288
	90.6	10	18	2.1	HJ 2313 E	0.298
	98.5	11	18	2.1	HJ 413	0.42
	89.5	7	11	1.5	HJ	

Bore Diameter 25 – 140 mm

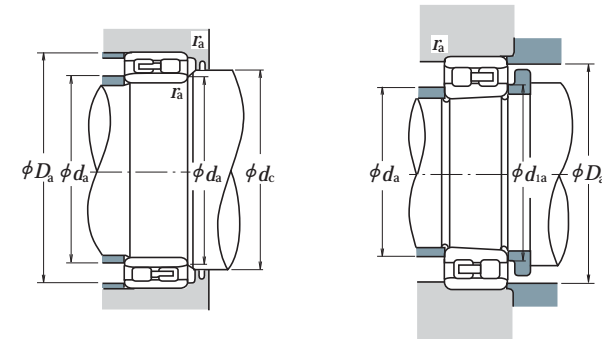
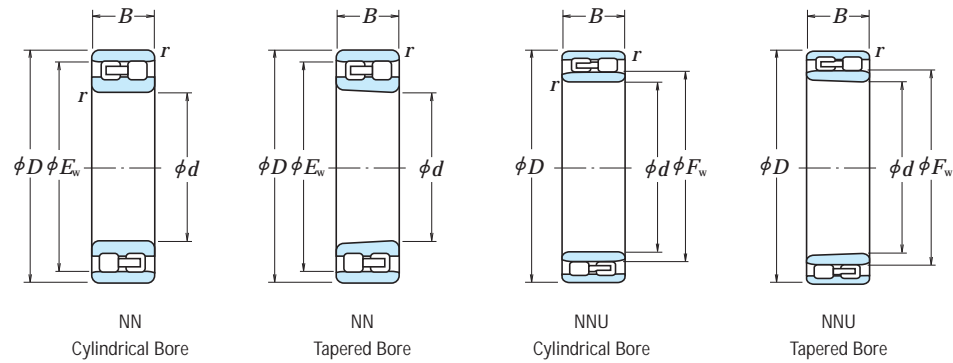

Boundary Dimensions (mm)						Basic Load Ratings (N)		Limiting Speeds (min ⁻¹)	
<i>d</i>	<i>D</i>	<i>B</i>	<i>r</i> _{min.}	<i>F_w</i>	<i>E_w</i>	<i>C_r</i>	<i>C_{0r}</i>	Grease	Oil
25	47	16	0.6	—	41.3	25 800	30 000	14 000	17 000
30	55	19	1	—	48.5	31 000	37 000	12 000	14 000
35	62	20	1	—	55	39 500	50 000	10 000	12 000
40	68	21	1	—	61	43 500	55 500	9 000	11 000
45	75	23	1	—	67.5	52 000	68 500	8 500	10 000
50	80	23	1	—	72.5	53 000	72 500	7 500	9 000
55	90	26	1.1	—	81	69 500	96 500	6 700	8 000
60	95	26	1.1	—	86.1	73 500	106 000	6 300	7 500
65	100	26	1.1	—	91	77 000	116 000	6 000	7 100
70	110	30	1.1	—	100	97 500	148 000	5 600	6 700
75	115	30	1.1	—	105	96 500	149 000	5 300	6 300
80	125	34	1.1	—	113	119 000	186 000	4 800	6 000
85	130	34	1.1	—	118	125 000	201 000	4 500	5 600
90	140	37	1.5	—	127	143 000	228 000	4 300	5 000
95	145	37	1.5	—	132	150 000	246 000	4 000	5 000
100	140	40	1.1	112	—	155 000	295 000	4 000	5 000
	150	37	1.5	—	137	157 000	265 000	4 000	4 800
105	145	40	1.1	117	—	161 000	315 000	3 800	4 800
	160	41	2	—	146	198 000	320 000	3 800	4 500
110	150	40	1.1	122	—	167 000	335 000	3 600	4 500
	170	45	2	—	155	229 000	375 000	3 400	4 300
120	165	45	1.1	133.5	—	183 000	360 000	3 200	4 000
	180	46	2	—	165	239 000	405 000	3 200	3 800
130	180	50	1.5	144	—	274 000	545 000	3 000	3 800
	200	52	2	—	182	284 000	475 000	3 000	3 600
140	190	50	1.5	154	—	283 000	585 000	2 800	3 600
	210	53	2	—	192	298 000	515 000	2 800	3 400

Note (1) The suffix K represents bearings with tapered bores (taper 1 : 12).

Remarks Production of double-row cylindrical roller bearings is generally in the high precision classes (Class 5 or better).

Bearing Numbers		Abutment and Fillet Dimensions (mm)						Mass (kg)
Cylindrical Bore	Tapered Bore ⁽¹⁾	<i>d_a</i> ⁽²⁾		<i>d_{1a}</i>		<i>D_a</i>		approx.
		min.	max.	min.	max.	min.	max.	
NN 3005	NN 3005 K	29	—	29	—	43	42	0.127
NN 3006	NN 3006 K	35	—	36	—	50	50	0.198
NN 3007	NN 3007 K	40	—	41	—	57	56	0.258
NN 3008	NN 3008 K	45	—	46	—	63	62	0.309
NN 3009	NN 3009 K	50	—	51	—	70	69	0.407
NN 3010	NN 3010 K	55	—	56	—	75	74	0.436
NN 3011	NN 3011 K	61.5	—	62	—	83.5	83	0.647
NN 3012	NN 3012 K	66.5	—	67	—	88.5	88	0.693
NN 3013	NN 3013 K	71.5	—	72	—	93.5	93	0.741
NN 3014	NN 3014 K	76.5	—	77	—	103.5	102	1.06
NN 3015	NN 3015 K	81.5	—	82	—	108.5	107	1.11
NN 3016	NN 3016 K	86.5	—	87	—	118.5	115	1.54
NN 3017	NN 3017 K	91.5	—	92	—	123.5	120	1.63
NN 3018	NN 3018 K	98	—	99	—	132	129	2.09
NN 3019	NN 3019 K	103	—	104	—	137	134	2.19
NNU 4920	NNU 4920 K	106.5	111	108	115	133.5	—	1.9
NN 3020	NN 3020 K	108	—	109	—	142	139	2.28
NNU 4921	NNU 4921 K	111.5	116	113	120	138.5	—	1.99
NN 3021	NN 3021 K	114	—	115	—	151	148	2.88
NNU 4922	NNU 4922 K	116.5	121	118	125	143.5	—	2.07
NN 3022	NN 3022 K	119	—	121	—	161	157	3.71
NNU 4924	NNU 4924 K	126.5	133	128	137	158.5	—	2.85
NN 3024	NN 3024 K	129	—	131	—	171	167	4.04
NNU 4926	NNU 4926 K	138	143	140	148	172	—	1.5
NN 3026	NN 3026 K	139	—	141	—	191	185	5.88
NNU 4928	NNU 4928 K	148	153	150	158	182	—	1.5
NN 3028	NN 3028 K	149	—	151	—	201	195	6.34

Note (2) *d_a* (max.) are values for adjusting rings for the NNU Type.

Bore Diameter 150 – 360 mm

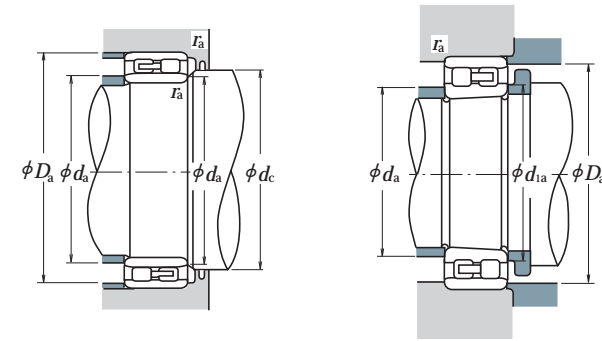
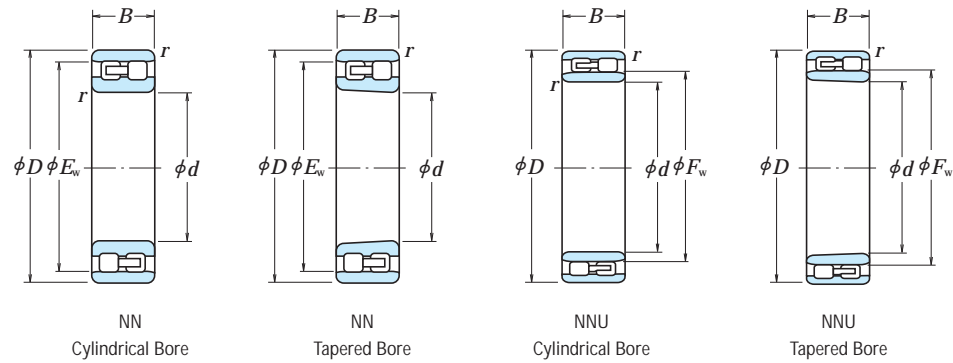

d	Boundary Dimensions (mm)					Basic Load Ratings (N)		Limiting Speeds (min ⁻¹)	
	D	B	r _{min.}	F _W	E _W	C _r	C _{0r}	Grease	Oil
150	210	60	2	167	—	350 000	715 000	2 600	3 200
	225	56	2.1	—	206	335 000	585 000	2 600	3 000
160	220	60	2	177	—	365 000	760 000	2 400	3 000
	240	60	2.1	—	219	375 000	660 000	2 400	2 800
170	230	60	2	187	—	375 000	805 000	2 400	2 800
	260	67	2.1	—	236	450 000	805 000	2 200	2 600
180	250	69	2	200	—	480 000	1 020 000	2 200	2 600
	280	74	2.1	—	255	565 000	995 000	2 000	2 400
190	260	69	2	211.5	—	485 000	1 060 000	2 000	2 600
	290	75	2.1	—	265	595 000	1 080 000	2 000	2 400
200	280	80	2.1	223	—	570 000	1 220 000	1 900	2 400
	310	82	2.1	—	282	655 000	1 170 000	1 800	2 200
220	300	80	2.1	243	—	600 000	1 330 000	1 700	2 200
	340	90	3	—	310	815 000	1 480 000	1 700	2 000
240	320	80	2.1	263	—	625 000	1 450 000	1 600	2 000
	360	92	3	—	330	855 000	1 600 000	1 500	1 800
260	360	100	2.1	289	—	935 000	2 100 000	1 400	1 800
	400	104	4	—	364	1 030 000	1 920 000	1 400	1 700
280	380	100	2.1	309	—	960 000	2 230 000	1 300	1 700
	420	106	4	—	384	1 080 000	2 080 000	1 300	1 500
300	420	118	3	336	—	1 230 000	2 870 000	1 200	1 500
	460	118	4	—	418	1 290 000	2 460 000	1 200	1 400
320	440	118	3	356	—	1 260 000	3 050 000	1 100	1 400
	480	121	4	—	438	1 350 000	2 670 000	1 100	1 300
340	520	133	5	—	473	1 670 000	3 300 000	1 000	1 200
360	540	134	5	—	493	1 700 000	3 450 000	950	1 200

Bearing Numbers		Abutment and Fillet Dimensions (mm)						Mass (kg)	
Cylindrical Bore	Tapered Bore ⁽¹⁾	d _a ⁽²⁾		d _{1a}	d _c	D _a		approx.	
		min.	max.	min.	min.	max.	r _a min. max.		
NNU 4930 NN 3030	NNU 4930 K NN 3030 K	159	166	162	171	201	—	2	6.39
		161	—	162	—	214	209	2	7.77
NNU 4932 NN 3032	NNU 4932 K NN 3032 K	169	176	172	182	211	—	2	6.76
		171	—	172	—	229	222	2	9.41
NNU 4934 NN 3034	NNU 4934 K NN 3034 K	179	186	182	192	221	—	2	7.12
		181	—	183	—	249	239	2	12.8
NNU 4936 NN 3036	NNU 4936 K NN 3036 K	189	199	193	205	241	—	2	10.4
		191	—	193	—	269	258	2	16.8
NNU 4938 NN 3038	NNU 4938 K NN 3038 K	199	211	203	217	251	—	2	10.9
		201	—	203	—	279	268	2	17.8
NNU 4940 NN 3040	NNU 4940 K NN 3040 K	211	222	214	228	269	—	2	15.3
		211	—	214	—	299	285	2	22.7
NNU 4944 NN 3044	NNU 4944 K NN 3044 K	231	242	234	248	289	—	2	16.6
		233	—	236	—	327	313	2.5	29.6
NNU 4948 NN 3048	NNU 4948 K NN 3048 K	251	262	254	269	309	—	2	18
		253	—	256	—	347	334	2.5	32.7
NNU 4952 NN 3052	NNU 4952 K NN 3052 K	271	288	275	295	349	—	2	31.1
		276	—	278	—	384	368	3	47.7
NNU 4956 NN 3056	NNU 4956 K NN 3056 K	291	308	295	315	369	—	2	33
		296	—	298	—	404	388	3	51.1
NNU 4960 NN 3060	NNU 4960 K NN 3060 K	313	335	318	343	407	—	2.5	51.9
		316	—	319	—	444	422	3	70.7
NNU 4964 NN 3064	NNU 4964 K NN 3064 K	333	355	338	363	427	—	2.5	54.9
		336	—	340	—	464	442	3	76.6
NNU 3068	NN 3068 K	360	—	365	—	500	477	4	102
NN 3072	NN 3072 K	380	—	385	—	520	497	4	106

Note ⁽¹⁾ The suffix K represents bearings with tapered bores (taper 1 : 12).

Remarks Production of double-row cylindrical roller bearings is generally in the high precision classes (Class 5 or better).

Note ⁽²⁾ d_a (max.) are values for adjusting rings for the NNU Type.

TAPERED ROLLER BEARINGS

METRIC DESIGN TAPERED ROLLER BEARINGS

Bore Diameter 15 – 100mm	B120
Bore Diameter 105 – 240mm	B128
Bore Diameter 260 – 440mm	B134

INCH DESIGN TAPERED ROLLER BEARINGS

Bore Diameter 12.000 – 47.625mm	B136
Bore Diameter 48.412 – 69.850mm	B150
Bore Diameter 70.000 – 206.375mm	B158

The index for inch design tapered roller bearings is in Appendix 14 (Page C26).

DOUBLE-ROW TAPERED ROLLER BEARINGS

Bore Diameter 40 – 260mm	B172
--------------------------	------

Four-Row Tapered Roller Bearings are described on pages B334 to B339.



DESIGN, TYPES, AND FEATURES

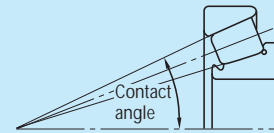

Tapered roller bearings are designed so the apices of the cones formed by the raceways of the cone and cup and the conical rollers all coincide at one point on the axis of the bearing. When a radial load is imposed, an axial force component occurs; therefore, it is necessary to use two bearings in opposition or some other multiple arrangement.

For metric-design medium-angle and steep-angle tapered roller bearings, the respective contact angle symbol C or D is added after the bore number. For normal-angle tapered roller bearings, no contact angle symbol is used. Medium-angle tapered roller bearings are primarily used for the pinion shafts of differential gears of automobiles.

Among those with high load capacity (HR series), some bearings have the basic number suffixed by J to conform to the specifications of ISO for the cup back face raceway diameter, cup width, and contact angle. Therefore, the cone assembly and cup of bearings with the same basic number suffixed by J are internationally interchangeable.

Among metric-design tapered roller bearings specified by ISO 355, there are those having new dimensions that are different than the dimension series 3XX used in the past. Part of them are listed in the bearing tables. They conform to the specifications of ISO for the smaller end diameter of the cup and contact angle. The cone and cup assemblies are internationally interchangeable. The bearing number formulation, which is different than that for past metric design, is as follows:

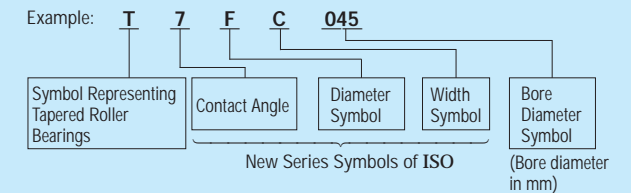

Besides metric design tapered roller bearings, there are also inch design bearings. For the cone assemblies and cups of inch design bearings, except four-row tapered roller bearings, the bearing numbers are approximately formulated as follows:

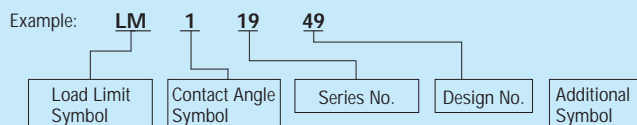

For tapered roller bearings, besides single-row bearings, there are also various combinations of bearings. The cages of tapered roller bearings are usually pressed steel.

Table 1 Design and Featured of Combinations of Tapered Roller Bearings

Figure	Arrangement	Examples of Bearing No.	Features
	Back-to-back	HR30210JDB+KLR10	Two standard bearings are combined. The bearing clearances are adjusted by cone spacers or cup spacers. The cones and cups and spacers are marked with serial numbers and mating marks. Components with the same serial number can be assembled referring to the matching symbols.
	Face-to-face	HR30210JDF+KR	
	KBE Type	100KBE31+L	The KBE type is a back-to-back arrangement of bearings with the cup and spacer integrated, and the KH type is a face-to-face arrangement in which the cones are integrated. Since the bearing clearance is adjusted using spacers, it is necessary for components to have the same serial number for assembly with reference to matching symbols.
	KH Type	110KH31+K	

TOLERANCES AND RUNNING ACCURACY

- METRIC DESIGN TAPERED ROLLER BEARINGS Table 8.3 (Pages A64 to A67)
- INCH DESIGN TAPERED ROLLER BEARINGS Table 8.4 (Pages A68 and A69)

Among inch design tapered roller bearings, there are those to which the following precision classes apply. For more details, please consult with NSK.

(1) J line bearings(in the bearing tables, bearings preceded by ▲)

Table 2 Tolerances for Cones(CLASS K)

Units : μm

Nominal Bore Diameter d (mm)		Δd_{mp}		V_{dp}	V_{dmp}	K_{ja}
over	incl.	high	low	max.	max.	max.
10	18	0	-12	12	9	15
18	30	0	-12	12	9	18
30	50	0	-12	12	9	20
50	80	0	-15	15	11	25
80	120	0	-20	20	15	30
120	180	0	-25	25	19	35
180	250	0	-30	30	23	50
250	315	0	-35	35	26	60
315	400	0	-40	40	30	70

Table 3 Tolerances for Cups(CALSS K)

Units : μm

Nominal Outside Diameter D (mm)		ΔD_{mp}		V_{Dp}	V_{Dmp}	K_{ea}
over	incl.	high	low	max.	max.	max.
18	30	0	-12	12	9	18
30	50	0	-14	14	11	20
50	80	0	-16	16	12	25
80	120	0	-18	18	14	35
120	150	0	-20	20	15	40
150	180	0	-25	25	19	45
180	250	0	-30	30	23	50
250	315	0	-35	35	26	60
315	400	0	-40	40	30	70
400	500	0	-45	45	34	80

Table 4 Tolerances for Effective Widths of Cone Assemblies and Cups, and Overall Width (CLASS K)

Units : μm

Nominal Bore Diameter d (mm)		Effective Width Deviation of Cone Assembly ΔT_{1s}		Effective Width Deviation of Cup ΔT_{2s}		Overall Width Deviation ΔT_s	
over	incl.	high	low	high	low	high	low
10	80	+100	0	+100	0	+200	0
80	120	+100	-100	+100	-100	+200	-200
120	315	+150	-150	+200	-100	+350	-250
315	400	+200	-200	+200	-200	+400	-400

(2) Bearings for Front Axles of Automobiles
(In the bearing tables, those preceded by t)

Table 5 Tolerances for Bore Diameter and Overall Width

Units : μm

Nominal Bore Diameter d				Bore Diameter Deviation Δd_s		Overall Width Deviation ΔT_s	
over	incl.		high	low	high	low	
(mm)	1/25.4	(mm)	1/25.4				
—		76.200	3.0000	+20	0	+356	0

The tolerances for outside diameter and those for radial runout of the cones and cups conform to Table 8.4.2 (Pages A68 and A69).

(3) Special Chamfer Dimensions

For bearings marked "spec." in the column of r in the bearing tables, the chamfer dimension of the cone back-face side is as shown on the following figure.

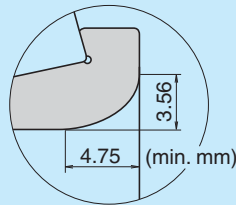

RECOMMENDED FITS

METRIC DESIGN TAPERED ROLLER BEARINGS	Table 9.2 (Page A84) Table 9.4 (Page A85)
INCH DESIGN TAPERED ROLLER BEARINGS	Table 9.6 (Page A86) Table 9.7 (Page A87)

INTERNAL CLEARANCE

METRIC DESIGN TAPERED ROLLER BEARINGS (Matched and Double-Row)	Table 9.16 (Page A93)
INCH DESIGN TAPERED ROLLER BEARINGS (Matched and Double-Row)	Table 9.16 (Page A93)

DIMENSIONS RELATED TO MOUNTING

The dimensions related to mounting tapered roller bearings are listed in the bearing tables. Since the cages protrude from the ring faces of tapered roller bearings, please use care when designing shafts and housings.

When heavy axial loads are imposed, the shaft shoulder dimensions and strength must be sufficient to support the cone rib.

PERMISSIBLE MISALIGNMENT

The permissible misalignment angle for tapered roller bearings is approximately 0.0009 radian (3').

LIMITING SPEEDS

The limiting speeds listed in the bearing tables should be adjusted depending on the bearing load conditions. Also, higher speeds are attainable by making changes in the lubrication method, cage design, etc. Refer to Page A37 for detailed information.

PRECAUTIONS FOR USE OF TAPERED ROLLER BEARINGS

1. If the load on tapered roller bearings becomes too small, or if the ratio of the axial and radial loads for matched bearings exceeds 'e' (e is listed in the bearing tables) during operation, slippage between the rollers and raceways occurs, which may result in smearing. Especially with large bearings since the weight of the rollers and cage is high. If such load conditions are expected, please contact NSK for selection of the bearings.
2. Confirm the dimension of "Abutment and Fillet Dimensions" of D_a , D_b , S_a , S_b at the time of the HR series adoption.

Bore Diameter 15 – 28 mm

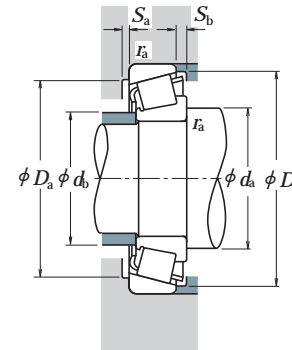
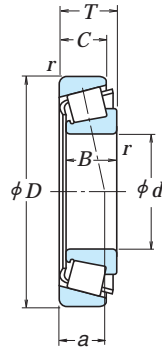

Dynamic Equivalent Load

$$P = X F_r + Y F_a$$

$F_a / F_r \leq e$		$F_a / F_r > e$	
X	Y	X	Y
1	0	0.4	Y_1

Static Equivalent Load

$$P_0 = 0.5 F_r + Y_0 F_a$$

When $F_r > 0.5 F_r + Y_0 F_a$, use $P_0 = F_r$

The values of e , Y_1 , and Y_0 are given in the table below.

Boundary Dimensions (mm)							Basic Load Ratings (N) (kgf)				Limiting Speeds (min ⁻¹)	
d	D	T	B	C	Cone r min.	Cup r min.	C _r	C _{0r}	C _r	C _{0r}	Grease	Oil
15	35	11.75	11	10	0.6	0.6	14 800	13 200	1 510	1 350	11 000	15 000
	42	14.25	13	11	1	1	23 600	21 100	2 400	2 160	9 500	13 000
17	40	13.25	12	11	1	1	20 100	19 900	2 050	2 030	9 500	13 000
	40	17.25	16	14	1	1	27 100	28 000	2 770	2 860	9 500	13 000
	47	15.25	14	12	1	1	29 200	26 700	2 980	2 720	8 500	12 000
	47	15.25	14	10.5	1	1	22 000	20 300	2 240	2 070	8 000	11 000
20	47	20.25	19	16	1	1	37 500	36 500	3 800	3 750	8 500	11 000
	42	15	15	12	0.6	0.6	24 600	27 400	2 510	2 800	9 000	12 000
22	47	15.25	14	12	1	1	27 900	28 500	2 850	2 900	8 000	11 000
	47	15.25	14	12	0.3	1	23 900	24 000	2 430	2 450	8 000	11 000
	47	19.25	18	15	1	1	35 500	37 500	3 650	3 850	8 500	11 000
	47	19.25	18	15	1	1	31 500	33 500	3 200	3 400	8 000	11 000
	52	16.25	15	13	1.5	1.5	35 000	33 500	3 550	3 400	7 500	10 000
	52	16.25	15	12	1.5	1.5	25 300	24 500	2 580	2 490	7 100	10 000
	52	22.25	21	18	1.5	1.5	45 500	47 500	4 650	4 850	8 000	11 000
	50	15.25	14	12	1	1	25 600	29 400	2 610	3 000	8 500	11 000
	50	15.25	14	12	1	1	29 200	30 500	2 980	3 150	7 500	10 000
	50	15.25	14	12	1	1	27 200	29 500	2 780	3 000	7 500	10 000
25	50	19.25	18	15	1	1	36 500	40 500	3 750	4 100	7 500	11 000
	50	19.25	18	15	1	1	33 500	39 500	3 400	4 000	7 500	10 000
	56	17.25	16	14	1.5	1.5	37 000	36 500	3 750	3 750	7 100	9 500
	56	17.25	16	13	1.5	1.5	34 500	34 000	3 500	3 500	6 700	9 500
	47	15	15	11.5	0.6	0.6	27 400	33 000	2 800	3 400	8 000	11 000
	47	17	17	14	0.6	0.6	31 000	38 000	3 150	3 900	8 000	11 000
	52	16.25	15	13	1	1	32 000	35 000	3 300	3 550	7 100	10 000
	52	16.25	15	12	1	1	28 100	31 500	2 860	3 200	9 700	9 500
	52	19.25	18	16	1	1	40 000	45 000	4 050	4 600	7 100	10 000
	52	19.25	18	15	1	1	35 000	42 000	3 550	4 250	7 100	9 500
28	52	22	22	18	1	1	47 500	56 500	4 850	5 750	7 500	10 000
	62	18.25	17	15	1.5	1.5	47 500	46 000	4 850	4 700	6 300	8 500
	62	18.25	17	14	1.5	1.5	42 000	45 000	4 300	4 550	6 000	8 500
	62	18.25	17	13	1.5	1.5	38 000	40 500	3 900	4 100	5 600	8 000
	62	18.25	17	13	1.5	1.5	38 000	40 500	3 900	4 100	5 600	8 000
	62	25.25	24	20	1.5	1.5	62 500	66 000	6 400	6 750	6 300	8 500
	52	16	16	12	1	1	32 000	39 000	3 300	3 950	7 100	9 500
	58	17.25	16	14	1	1	39 500	41 500	4 050	4 200	6 300	9 000
	58	17.25	16	12	1	1	34 000	38 500	3 450	3 900	6 300	8 500
	58	20.25	19	16	1	1	47 500	54 000	4 850	5 500	6 300	9 000
58	20.25	19	16	1	1	42 000	49 500	4 300	5 050	6 300	9 000	
68	19.75	18	15	1.5	1.5	55 000	55 500	5 650	5 650	6 000	8 000	
68	19.75	18	14	1.5	1.5	49 500	50 500	5 000	5 150	5 600	7 500	

Bearing Numbers	ISO355 Dimension Series approx.	Abutment and Fillet Dimensions (mm)								Eff. Load Centers (mm) a	Constant e	Axial Load Factors		Mass (kg) approx.	
		d _a min.	d _b max.	D _a max.	D _b min.	S _a min.	S _b min.	Cone r _a max.	Cup r _a max.			Y ₁	Y ₀		
30202	—	23	19	30	30	33	2	1.5	0.6	0.6	8.2	0.32	1.9	1.0	0.053
HR 30302 J	2FB	24	22	36	36	38.5	2	3	1	1	9.5	0.29	2.1	1.2	0.098
HR 30203 J	2DB	26	23	34	34	37.5	2	2	1	1	9.7	0.35	1.7	0.96	0.079
HR 32203 J	2DD	26	22	34	34	37	2	3	1	1	11.2	0.31	1.9	1.1	0.103
HR 30303 J	2FB	26	24	41	40	43	2	3	1	1	10.4	0.29	2.1	1.2	0.134
30303 D	—	29	23	41	34	44	2	4.5	1	1	15.4	0.81	0.74	0.41	0.129
HR 32303 J	2FD	28	23	41	39	43	2	4	1	1	12.5	0.29	2.1	1.2	0.178
HR 32004 XJ	3CC	28	24	37	35	40	3	3	0.6	0.6	10.6	0.37	1.6	0.88	0.097
HR 30204 J	2DB	29	27	41	40	44	2	3	1	1	11.0	0.35	1.7	0.96	0.127
HR 30204 C-A-	—	29	26	41	37	44	2	3	0.3	1	13.0	0.55	1.1	0.60	0.126
HR 32204 J	2DD	29	25	41	38	44.5	3	4	1	1	12.6	0.33	1.8	1.0	0.161
HR 32204 CJ	5DD	29	25	41	36	44	2	4	1	1	14.5	0.52	1.2	0.64	0.166
HR 30304 J	2FB	31	27	44	44	47.5	2	3	1.5	1.5	11.6	0.30	2.0	1.1	0.172
30304 D	—	34	26	43	37	49	2	4	1.5	1.5	16.7	0.81	0.74	0.41	0.168
HR 32304 J	2FD	33	26	43	42	48	3	4	1.5	1.5	13.9	0.30	2.0	1.1	0.241
HR 320/22 XJ	3CC	30	27	39	37	42	3	3.5	0.6	0.6	11.1	0.40	1.5	0.83	0.103
HR 302/22	—	31	29	44	42	47	2	3	1	1	11.6	0.37	1.6	0.90	0.139
HR 302/22 C	—	31	29	44	40	47	2	3	1	1	13.0	0.49	1.2	0.67	0.144
HR 322/22	—	31	28	44	41	47	2	4	1	1	13.5	0.37	1.6	0.89	0.18
HR 322/22 C	—	31	29	44	39	48	2	4	1	1	15.2	0.51	1.2	0.65	0.185
HR 303/22	—	33	30	47	46	50	2	3	1.5	1.5	12.4	0.32	1.9	1.0	0.208
HR 303/22 C	—	33	30	47	44	52.5	3	4	1.5	1.5	15.9	0.59	1.0	0.56	0.207
HR 32005 XJ	4CC	33	30	42	40	45	3	3.5	0.6	0.6	11.8	0.43	1.4	0.77	0.116
HR 33005 J	2CE	33	29	42	41	44	3	3	0.6	0.6	11.0	0.29	2.1	1.1	0.131
HR 30205 J	3CC	34	31	46	44	48.5	2	3	1	1	12.7	0.37	1.6	0.88	0.157
HR 30205 C	—	34	32	46	43	49.5	2	4	1	1	14.4	0.53	1.1	0.62	0.155
HR 32205 J	2CD	34	30	46	44	50	2	3	1	1	13.5	0.36	1.7	0.92	0.189
HR 32205 C	—	34	30	46	40	50	2	4	1	1	15.8	0.53	1.1	0.62	0.19
HR 33205 J	2DE	34	29	46	43	49.5	4	4	1	1	14.1	0.35	1.7	0.94	0.221
HR 30305 J	2FB	36	34	54	54	57	2	3	1.5	1.5	13.2	0.30	2.0	1.1	0.27
HR 30305 C	—	36	35	53	49	58.5	3	4	1.5	1.5	16.4	0.55	1.1	0.60	0.276
HR 30305 DJ	(7FB)	39	34	53	47	59	2	5	1.5	1.5	19.9	0.83	0.73	0.40	0.265
HR 31305 J	7FB	39	33	53	47	59	3	5	1.5	1.5	19.9	0.83	0.73	0.40	0.265
HR 32305 J	2FD	38	32	53	51	57	3	5	1.5	1.5	15.6	0.30	2.0	1.1	0.376
HR 320/28 XJ	4CC	37	33	46	44	50	3	4	1	1	12.8	0.43	1.4	0.77	0.146
HR 302/28	—	37	34	52	50	55	2	3	1	1	13.2	0.35	1.7	0.93	0.203
HR 302/28 C	—	37	34	52	48	54	2	5	1	1	16.9	0.64	0.94	0.52	0.198
HR 322/28	—	37	34	52	49	55	2	4	1	1	14.6	0.37	1.6	0.89	0.243
HR 322/28 CJ	5DD	37	33	52	45	55	2	4	1	1	16.8	0.56	1.1	0.59	0.251
HR 3															

Bore Diameter 30 – 35 mm

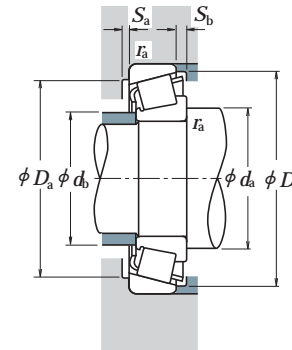
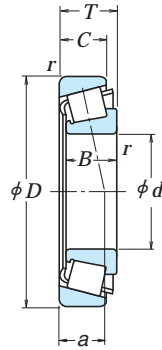

Dynamic Equivalent Load

$$P = XF_r + YF_a$$

$F_a/F_r \leq e$		$F_a/F_r > e$	
X	Y	X	Y
1	0	0.4	Y_1

Static Equivalent Load

$$P_0 = 0.5F_r + Y_0F_a$$

When $F_r > 0.5F_r + Y_0F_a$, use $P_0 = F_r$

The values of e , Y_1 , and Y_0 are given in the table below.

Boundary Dimensions (mm)							Basic Load Ratings				Limiting Speeds		
d	D	T	B	C	Cone r	Cup r	(N)		(kgf)		(min ⁻¹)		
					min.		C_r	C_{0r}	C_r	C_{0r}	Grease	Oil	
30	47	12	12	9	0.3	0.3	17 600	24 400	1 800	2 490	7 500	10 000	
	55	17	17	13	1	1	36 000	44 500	3 700	4 550	6 700	9 000	
	55	20	20	16	1	1	42 000	54 000	4 250	5 500	6 700	9 000	
	62	17.25	16	14	1	1	43 000	47 500	4 400	4 850	6 000	8 000	
	62	17.25	16	12	1	1	35 500	37 000	3 650	3 800	5 600	7 500	
	62	21.25	20	17	1	1	52 000	60 000	5 300	6 150	6 000	8 500	
	62	21.25	20	16	1	1	48 000	56 000	4 900	5 750	6 000	8 000	
	62	25	25	19.5	1	1	66 500	79 500	6 800	8 100	6 000	8 000	
	72	20.75	19	16	1.5	1.5	59 500	60 000	6 050	6 100	5 300	7 500	
	72	20.75	19	14	1.5	1.5	56 500	55 500	5 800	5 650	5 300	7 100	
	72	20.75	19	14	1.5	1.5	49 000	52 500	5 000	5 350	4 800	6 700	
	72	20.75	19	14	1.5	1.5	49 000	52 500	5 000	5 350	4 800	6 800	
72	28.75	27	23	1.5	1.5	80 000	88 500	8 150	9 000	5 600	7 500		
72	28.75	27	23	1.5	1.5	76 000	86 500	7 750	8 800	5 600	7 500		
32	58	17	17	13	1	1	37 500	47 000	3 800	4 800	6 300	8 500	
	58	21	20	16	1	1	41 000	50 000	4 150	5 100	6 300	8 500	
	65	18.25	17	15	1	1	48 500	54 000	4 950	5 500	5 600	8 000	
	65	18.25	17	14	1	1	45 500	52 500	4 650	5 350	5 600	7 500	
	65	22.25	21	18	1	1	56 000	65 000	5 700	6 650	6 000	8 000	
	65	22.25	21	17	1	1	49 500	60 000	5 050	6 100	5 600	7 500	
	65	26	26	20.5	1	1	70 000	86 500	7 150	8 850	5 600	8 000	
	75	21.75	20	17	1.5	1.5	56 000	56 000	5 700	5 700	5 300	7 100	
	35	55	14	14	11.5	0.6	0.6	27 400	39 000	2 790	3 950	6 300	8 500
		62	18	18	14	1	1	43 500	55 500	4 400	5 650	5 600	8 000
		62	21	21	17	1	1	49 000	65 000	4 950	6 650	5 600	8 000
		72	18.25	17	15	1.5	1.5	54 000	59 500	5 500	6 050	5 300	7 100
72		18.25	17	13	1.5	1.5	47 000	54 500	4 750	5 550	5 000	6 700	
72		24.25	23	19	1.5	1.5	70 500	83 500	7 150	8 550	5 300	7 100	
72		24.25	23	18	1.5	1.5	60 500	71 500	6 200	7 300	5 000	7 100	
72		28	28	22	1.5	1.5	86 500	108 000	8 850	11 100	5 300	7 100	
80		22.75	21	18	2	1.5	76 000	79 000	7 750	8 050	4 800	6 700	
80		22.75	21	16	2	1.5	68 000	70 500	6 900	7 200	4 800	6 300	
80		22.75	21	15	2	1.5	62 000	68 000	6 350	6 950	4 300	6 000	
80		22.75	21	15	2	1.5	62 000	68 000	6 350	6 950	4 300	6 000	
80	32.75	31	25	2	1.5	99 000	111 000	10 100	11 300	5 000	6 700		

Remarks The suffix C represents medium-angle tapered roller bearings. Since they are designed for specific applications, please consult NSK when using bearings with suffix C.

Bearing Numbers	ISO355 Dimension Series approx.	Abutment and Fillet Dimensions (mm)								Eff. Load Centers (mm) a	Constant e	Axial Load Factors		Mass (kg) approx.	
		d_a min.	d_b max.	D_a max.	D_b min.	S_a min.	S_b min.	Cone r_a max.	Cup r_a max.			Y_1	Y_0		
HR 32906 J HR 32006 XJ HR 33006 J	2BD	34	34	44	42	44	3	3	0.3	0.3	9.2	0.32	1.9	1.0	0.074
	4CC	39	35	49	47	53	3	4	1	1	13.5	0.43	2.4	0.77	0.172
	2CE	39	35	49	48	52	3	4	1	1	13.1	0.29	2.1	1.1	0.208
HR 30206 J HR 30206 C HR 32206 J	3DB	39	37	56	52	58	2	3	1	1	13.9	0.37	1.6	0.88	0.238
	—	39	36	56	49	59	2	5	1	1	17.8	0.68	0.88	0.49	0.221
	3DC	39	36	56	51	58.5	2	4	1	1	15.4	0.37	1.6	0.88	0.297
HR 32206 C HR 33206 J HR 30306 J HR 30306 C	—	39	35	56	48	59	2	5	1	1	17.8	0.55	1.1	0.60	0.293
	2DE	39	35	56	52	59.5	5	5.5	1	1	16.1	0.34	1.8	0.97	0.355
	2FB	41	40	63	62	66	3	4.5	1.5	1.5	15.1	0.32	1.9	1.1	0.403
HR 30306 DJ HR 32306 J HR 32306 CJ	—	41	38	63	59	67	3	6.5	1.5	1.5	18.5	0.55	1.1	0.60	0.383
	(7FB)	44	40	63	55	68	3	6.5	1.5	1.5	23.1	0.83	0.73	0.40	0.393
	2FD	44	40	63	55	68	3	6.5	1.5	1.5	23.1	0.83	0.73	0.40	0.393
HR 32306 J HR 32306 CJ	2FD	43	38	63	59	66	3	5.5	1.5	1.5	18.0	0.32	1.9	1.1	0.57
	5FD	43	36	63	54	68	3	5.5	1.5	1.5	22.0	0.55	1.1	0.60	0.583
	—	43	36	63	54	68	3	5.5	1.5	1.5	22.0	0.55	1.1	0.60	0.583
HR 320/32 XJ HR 330/32 J HR 302/32 HR 302/32 C	4CC	41	37	52	49	55	3	4	1	1	14.2	0.45	1.3	0.73	0.191
	—	41	37	52	50	55	2	4	1	1	13.8	0.31	1.9	1.1	0.225
	—	41	39	59	56	61	3	3	1	1	14.7	0.37	1.6	0.88	0.277
HR 322/32 HR 322/32 C HR 332/32 J HR 303/32	—	41	39	59	54	62	3	4	1	1	16.9	0.55	1.1	0.60	0.273
	—	41	38	59	54	61	3	4	1	1	15.9	0.37	1.6	0.88	0.336
	—	41	39	59	51	62	3	5	1	1	20.2	0.59	1.0	0.56	0.335
HR 332/32 J HR 303/32	2DE	41	38	59	55	62	5	5.5	1	1	17.0	0.35	1.7	0.95	0.40
	—	44	42	66	64	68	3	4.5	1.5	1.5	15.9	0.33	1.8	1.0	0.435
	—	44	42	66	64	68	3	4.5	1.5	1.5	15.9	0.33	1.8	1.0	0.435
HR 32907 J HR 32007 XJ HR 33007 J	2BD	43	40	50	50	52.5	3	2.5	0.6	0.6	10.7	0.29	2.1	1.1	0.123
	4CC	44	40	56	54	60	4	4	1	1	15.0	0.45	1.3	0.73	0.229
	2CE	44	40	56	55	59	4	4	1	1	14.1	0.31	2.0	1.1	0.267
HR 30207 J HR 30207 C HR 32207 J	3DB	46	43	63	62	67	3	3	1.5	1.5	15.0	0.37	1.6	0.88	0.34
	—	46	44	63	59	68	3	5	1.5	1.5	19.6	0.66	0.91	0.50	0.331
	3DC	46	42	63	61	67.5	3	5	1.5	1.5	17.9	0.37	1.6	0.88	0.456
HR 32207 C HR 33207 J HR 30307 J	—	46	42	63	58	68.5	3	6	1.5	1.5	20.6	0.55	1.1	0.60	0.442
	2DE	46	41	63	61	68	5	6	1.5	1.5	18.3	0.35	1.7	0.93	0.54
	2FB	47	45	71	69	74	3	4.5	2	1.5	16.7	0.32	1.9	1.1	0.538
HR 30307 C HR 30307 DJ HR 31307 J HR 32307 J	—	47	44	71	65	74	3	6.5	2	1.5	20.3	0.55	1.1	0.60	0.518
	7FB	51	44	71	62	77	3	7.5	2	1.5	25.2	0.83	0.73	0.40	0.519
	7FB	51	44	71	62	77	3	7.5	2	1.5	25.2	0.83	0.73	0.40	0.52
	2FE	49	43	71	66	74	3	7.5	2	1.5	20.7	0.32	1.9	1.1	0.765

Bore Diameter 40 – 50 mm

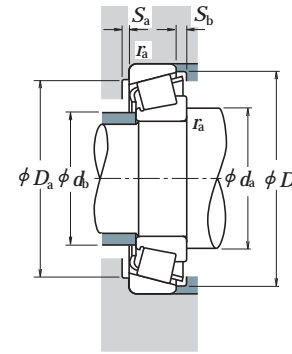
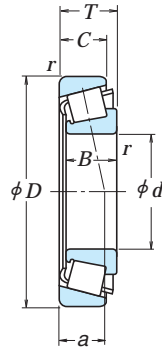

Dynamic Equivalent Load

$$P = X F_r + Y F_a$$

$F_a / F_r \leq e$		$F_a / F_r > e$	
X	Y	X	Y
1	0	0.4	Y_1

Static Equivalent Load

$$P_0 = 0.5 F_r + Y_0 F_a$$

When $F_r > 0.5 F_r + Y_0 F_a$, use $P_0 = F_r$

The values of e , Y_1 , and Y_0 are given in the table below.

Boundary Dimensions (mm)							Basic Load Ratings				Limiting Speeds		
d	D	T	B	C	Cone r min.	Cup r min.	(N)		(kgf)		Grease	Oil	
							C_r	C_{0r}	C_r	C_{0r}			
40	62	15	15	12	0.6	0.6	34 000	47 000	3 450	4 800	5 600	7 500	
	68	19	19	14.5	1	1	53 000	71 000	5 400	7 250	5 300	7 100	
	68	22	22	18	1	1	59 000	81 500	6 000	8 300	5 300	7 100	
	75	26	26	20.5	1.5	1.5	78 500	101 000	8 000	10 300	4 800	6 700	
	80	19.75	18	16	1.5	1.5	63 500	70 000	6 450	7 150	4 800	6 300	
	80	24.75	23	19	1.5	1.5	77 000	90 500	7 900	9 200	4 800	6 300	
	80	24.75	23	19	1.5	1.5	74 000	90 500	7 550	9 200	4 500	6 300	
	80	32	32	25	1.5	1.5	107 000	137 000	10 900	14 000	4 800	6 300	
	90	25.25	23	20	2	1.5	90 500	101 000	9 250	10 300	4 300	5 600	
	90	25.25	23	18	2	1.5	84 500	93 500	8 600	9 500	4 300	5 600	
	90	25.25	23	17	2	1.5	80 000	89 500	8 150	9 150	3 800	5 300	
	90	25.25	23	17	2	1.5	80 000	89 500	8 150	9 150	3 800	5 300	
	90	35.25	33	27	2	1.5	120 000	145 000	12 200	14 800	4 300	6 000	
	45	68	15	15	12	0.6	0.6	34 500	50 500	3 550	5 150	5 000	6 700
		75	20	20	15.5	1	1	60 000	83 000	6 150	8 450	4 500	6 300
		75	24	24	19	1	1	69 000	99 000	7 050	10 100	4 800	6 300
80		26	26	20.5	1.5	1.5	84 000	113 000	8 550	11 600	4 500	6 000	
85		20.75	19	16	1.5	1.5	68 500	79 500	6 950	8 100	4 300	6 000	
85		24.75	23	19	1.5	1.5	83 000	102 000	8 500	10 400	4 300	6 000	
85		24.75	23	19	1.5	1.5	75 500	95 500	7 700	9 750	4 300	5 600	
85		32	32	25	1.5	1.5	111 000	147 000	11 300	15 000	4 300	6 000	
95		29	26.5	20	2.5	2.5	88 500	109 000	9 050	11 100	3 600	5 000	
95		36	35	30	2.5	2.5	139 000	174 000	14 200	17 800	4 000	5 300	
100		27.25	25	22	2	1.5	112 000	127 000	11 400	12 900	3 800	5 300	
100		27.25	25	18	2	1.5	95 500	109 000	9 750	11 100	3 400	4 800	
100		27.25	25	18	2	1.5	95 500	109 000	9 750	11 100	3 400	4 800	
100		38.25	36	30	2	1.5	144 000	177 000	14 700	18 000	3 800	5 300	
50		100	36	35	30	2.5	2.5	144 000	185 000	14 600	18 800	3 800	5 000
		72	15	15	12	0.6	0.6	36 000	54 000	3 650	5 500	4 500	6 300
	80	20	20	15.5	1	1	61 000	87 000	6 250	8 900	4 300	6 000	
	80	24	24	19	1	1	70 500	104 000	7 150	10 600	4 300	6 000	
	85	26	26	20	1.5	1.5	89 000	126 000	9 100	12 800	4 300	5 600	
	90	21.75	20	17	1.5	1.5	76 000	91 500	7 750	9 300	4 000	5 300	
	90	24.75	23	19	1.5	1.5	87 500	109 000	8 900	11 100	4 000	5 300	
	90	24.75	23	18	1.5	1.5	77 500	102 000	7 900	10 400	3 800	5 300	
	90	32	32	24.5	1.5	1.5	118 000	165 000	12 100	16 800	4 000	5 300	
	105	32	29	22	3	3	109 000	133 000	11 100	13 600	3 200	4 500	
	110	29.25	27	23	2.5	2	130 000	148 000	13 300	15 100	3 400	4 800	
	110	29.25	27	19	2.5	2	114 000	132 000	11 700	13 400	3 200	4 300	
	110	29.25	27	19	2.5	2	114 000	132 000	11 700	13 400	3 200	4 300	
	110	42.25	40	33	2.5	2	176 000	220 000	17 900	22 400	3 600	4 800	
	110	42.25	40	33	2.5	2	164 000	218 000	16 800	22 200	3 400	4 800	

Remarks The suffix C represents medium-angle tapered roller bearings. Since they are designed for specific applications, please consult NSK when using bearings with suffix C.

Bearing Numbers	ISO355 Dimension Series approx.	Abutment and Fillet Dimensions (mm)						Cone r max.	Cup r max.	Eff. Load Centers (mm) a	Constant e	Axial Load Factors		Mass (kg) approx.	
		d_a min.	d_b max.	D_a max.	D_b min.	S_a min.	S_b min.					Y_1	Y_0		
HR 32908 J	2BC	48	44	57	57	59	3	3	0.6	0.6	11.5	0.29	2.1	1.1	0.161
HR 32008 XJ	3CD	49	45	62	60	65.5	4	4.5	1	1	15.0	0.38	1.6	0.87	0.28
HR 33008 J	2BE	49	45	62	61	65	4	4	1	1	14.6	0.28	2.1	1.2	0.322
HR 33108 J	2CE	51	46	66	65	71	4	5.5	1.5	1.5	18.0	0.36	1.7	0.93	0.503
HR 30208 J	3DB	51	48	71	69	75	3	3.5	1.5	1.5	16.6	0.37	1.6	0.88	0.437
HR 32208 J	3DC	51	48	71	68	75	3	5.5	1.5	1.5	18.9	0.37	1.6	0.88	0.548
HR 32208 CJ	5DC	51	47	71	65	76	3	5.5	1.5	1.5	21.9	0.55	1.1	0.60	0.558
HR 33208 J	2DE	51	46	71	67	76	5	7	1.5	1.5	20.8	0.36	1.7	0.92	0.744
HR 30308 J	2FB	52	52	81	76	82	3	5	2	1.5	19.5	0.35	1.7	0.96	0.758
HR 30308 C	—	52	50	81	72	84	3	7	2	1.5	22.8	0.53	1.1	0.62	0.735
HR 30308 DJ	7FB	56	50	81	70	87	3	8	2	1.5	28.7	0.83	0.73	0.40	0.728
HR 31308 J	7FB	56	50	81	70	87	3	8	2	1.5	28.7	0.83	0.73	0.40	0.728
HR 32308 J	2FD	54	50	81	73	82	3	8	2	1.5	23.4	0.35	1.7	0.96	1.05
HR 32909 J	2BC	53	50	63	62	64	3	3	0.6	0.6	12.3	0.32	1.9	1.0	0.187
HR 32009 XJ	3CC	54	51	69	67	72	4	4.5	1	1	16.6	0.39	1.5	0.84	0.354
HR 33009 J	2CE	54	51	69	67	71	4	5	1	1	16.3	0.29	2.0	1.1	0.414
HR 33109 J	3CE	56	51	71	69	77	4	5.5	1.5	1.5	19.1	0.38	1.6	0.86	0.552
HR 30209 J	3DB	56	53	76	74	80	3	4.5	1.5	1.5	18.3	0.41	1.5	0.81	0.488
HR 32209 J	3DC	56	53	76	73	81	3	5.5	1.5	1.5	20.1	0.41	1.5	0.81	0.602
HR 32209 CJ	5DC	56	52	76	70	82	3	5.5	1.5	1.5	23.6	0.59	1.0	0.56	0.603
HR 33209 J	3DE	56	51	76	72	81	5	7	1.5	1.5	22.0	0.39	1.6	0.86	0.817
T 7 FC045	7FC	60	53	83	71	91	3	9	2	2	32.1	0.87	0.69	0.38	0.918
T 2 ED045	2ED	60	54	83	79	89	5	6	2	2	23.5	0.32	1.9	1.02	1.22
HR 30309 J	2FB	57	58	91	86	93	3	5	2	1.5	21.1	0.35	1.7	0.96	1.01
HR 30309 DJ	7FB	61	57	91	79	96	3	9	2	1.5	31.5	0.83	0.73	0.40	0.957
HR 31309 J	7FB	61	57	91	79	96	3	9	2	1.5	31.5	0.83	0.73	0.40	0.947
HR 32309 J	2FD	59	56	91	82	93	3	8	2	1.5	25.0	0.35	1.7	0.96	1.42
T 2 ED050	2ED	65	59	88	83	94	6	6	2	2	24.2	0.34	1.8	0.96	1.3
HR 32910 J	2BC	58	54	67	66	69	3	3	0.6	0.6	13.5	0.34	1.8	0.97	0.193
HR 32010 XJ	3CC	59	56	74	71	77	4	4.5	1	1	17.9	0.42	1.4	0.78	0.38
HR 33010 J	2CE	59	55	74	71	76	4	5	1	1	17.4	0.32	1.9	1.0	0.452
HR 33110 J	3CE	61	56	76	74	82	4	6	1.5	1.5	20.3	0.41	1.5	0.8	0.597
HR 30210 J	3DB	61	58	81	79	85	3	4.5	1.5	1.5	19.6	0.42	1.4	0.79	0.557
HR 32210 J	3DC	61	57	81	78	86	3	5.5	1.5	1.5	21.0	0.42	1.4	0.79	0.642
HR 32210 CJ	5DC	61	58	81	76	87	3	6.5	1.5	1.5	24.6	0.59	1.0	0.56	0.655
HR 33210 J	3DE	61	56	81	76	87	5	7.5	1.5	1.5	23.2	0.41	1.5	0.80	0.867
T 7 FC050	7FC	74	59	91	78	100	5	10	2.5	2.5	36.4	0.87	0.69	0.38	1.22
HR 30310 J	2FB	65	65	100	95	102	3	6	2	2	23.1	0.35	1.7	0.96	1.28
HR 30310 DJ	7FB	70	62	100	87	105	3	10	2	2	34.3	0.83	0.73	0.40	1.26
HR 31310 J	7FB	70	62	100	87	105	3	10	2	2	34.3	0.83	0.73	0.40	1.26
HR 32310 J	2FD	68	62	100	91	102	3	9	2	2	28.0	0.35	1.7	0.96	1.88
HR 32310 CJ	5FD	68	59	100	82	103	3	9	2	2	32.8	0.55	1.1	0.60	1.93

Bore Diameter 55 – 65 mm

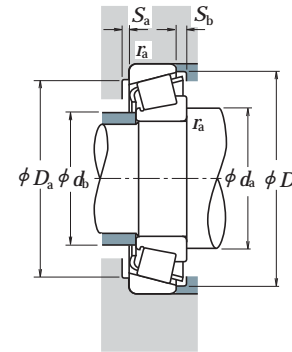
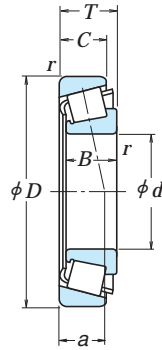

Dynamic Equivalent Load

$$P = XF_r + YF_a$$

$F_a / F_r \leq e$		$F_a / F_r > e$	
X	Y	X	Y
1	0	0.4	Y_1

Static Equivalent Load

$$P_0 = 0.5F_r + Y_0F_a$$

When $F_r > 0.5F_r + Y_0F_a$, use $P_0 = F_r$

The values of e , Y_1 , and Y_0 are given in the table below.

Boundary Dimensions (mm)							Basic Load Ratings				Limiting Speeds	
d	D	T	B	C	Cone	Cup	(N)		(kgf)		(min ⁻¹)	
					r	r	C_r	C_{0r}	C_r	C_{0r}	Grease	Oil
					min.	min.						
55	80	17	17	14	1	1	45 500	74 500	4 600	7 600	4 300	5 600
	90	23	23	17.5	1.5	1.5	81 500	117 000	8 300	11 900	3 800	5 300
	90	27	27	21	1.5	1.5	91 500	138 000	9 300	14 000	3 800	5 300
	95	30	30	23	1.5	1.5	112 000	158 000	11 500	16 100	3 800	5 000
	100	22.75	21	18	2	1.5	94 500	113 000	9 650	11 500	3 600	5 000
	100	26.75	25	21	2	1.5	110 000	137 000	11 200	14 000	3 600	5 000
	100	35	35	27	2	1.5	141 000	193 000	14 400	19 700	3 600	5 000
	115	34	31	23.5	3	3	126 000	164 000	12 800	16 700	3 000	4 300
	120	31.5	29	25	2.5	2	150 000	171 000	15 200	17 500	3 200	4 300
	120	31.5	29	21	2.5	2	131 000	153 000	13 400	15 600	2 800	4 000
	120	31.5	29	21	2.5	2	131 000	153 000	13 400	15 600	2 800	4 000
	120	45.5	43	35	2.5	2	204 000	258 000	20 800	26 300	3 200	4 300
120	45.5	43	35	2.5	2	195 000	262 000	19 900	26 700	3 200	4 300	
60	85	17	17	14	1	1	49 000	84 500	5 000	8 650	3 800	5 300
	95	23	23	17.5	1.5	1.5	85 500	127 000	8 700	12 900	3 600	5 000
	95	27	27	21	1.5	1.5	96 000	150 000	9 800	15 300	3 600	5 000
	100	30	30	23	1.5	1.5	115 000	166 000	11 700	16 900	3 400	4 800
	110	23.75	22	19	2	1.5	104 000	123 000	10 600	12 500	3 400	4 500
	110	29.75	28	24	2	1.5	131 000	167 000	13 400	17 000	3 400	4 500
	110	38	38	29	2	1.5	166 000	231 000	16 900	23 600	3 400	4 500
	125	37	33.5	26	3	3	151 000	197 000	15 400	20 100	2 800	3 800
	130	33.5	31	26	3	2.5	174 000	201 000	17 700	20 500	3 000	4 000
	130	33.5	31	22	3	2.5	151 000	177 000	15 400	18 100	2 600	3 800
	130	33.5	31	22	3	2.5	151 000	177 000	15 400	18 100	2 600	3 800
	130	48.5	46	37	3	2.5	233 000	295 000	23 700	30 000	3 000	4 000
130	48.5	46	35	3	2.5	196 000	249 000	20 000	25 400	2 800	3 800	
65	90	17	17	14	1	1	49 000	86 500	5 000	8 800	3 600	5 000
	100	23	23	17.5	1.5	1.5	86 500	132 000	8 800	13 500	3 400	4 500
	100	27	27	21	1.5	1.5	97 500	156 000	9 950	15 900	3 400	4 500
	110	34	34	26.5	1.5	1.5	148 000	218 000	15 100	22 200	3 200	4 300
	120	24.75	23	20	2	1.5	122 000	151 000	12 500	15 400	3 000	4 000
	120	32.75	31	27	2	1.5	157 000	202 000	16 000	20 600	3 000	4 000
	120	41	41	32	2	1.5	202 000	282 000	20 600	28 800	3 000	4 000
	140	36	33	28	3	2.5	200 000	233 000	20 400	23 800	2 600	3 600
	140	36	33	23	3	2.5	173 000	205 000	17 700	20 900	2 400	3 400
	140	36	33	23	3	2.5	173 000	205 000	17 700	20 900	2 400	3 400
	140	51	48	39	3	2.5	267 000	340 000	27 300	35 000	2 800	3 800

Bearing Numbers	ISO355 Dimension Series approx.	Abutment and Fillet Dimensions (mm)								Eff. Load Centers (mm) a	Constant e	Axial Load Factors		Mass (kg) approx.	
		d_a min.	d_b max.	D_a max.	D_b min.	S_a min.	S_b min.	Cone r_a max.	Cup r_a max.			Y_1	Y_0		
HR 32911 J	2BC	64	60	74	73	76	4	3	1	1	14.6	0.31	1.9	1.1	0.282
HR 32011 XJ	3CC	66	62	81	80	86	4	5.5	1.5	1.5	19.7	0.41	1.5	0.81	0.568
HR 33011 J	2CE	66	62	81	80	86	5	6	1.5	1.5	19.2	0.31	1.9	1.1	0.657
HR 33111 J	3CE	66	62	86	82	91	5	7	1.5	1.5	22.4	0.37	1.6	0.88	0.877
HR 30211 J	3DB	67	64	91	89	94	4	4.5	2	1.5	20.9	0.41	1.5	0.81	0.736
HR 32211 J	3DC	67	63	91	87	95	4	5.5	2	1.5	22.7	0.41	1.5	0.81	0.859
HR 33211 J	3DE	67	62	91	86	96	6	8	2	1.5	25.2	0.40	1.5	0.83	1.18
T 7 FC055	7FC	73	66	101	86	109	4	10.5	2.5	2.5	39.0	0.87	0.69	0.38	1.58
HR 30311 J	2FB	70	71	110	104	111	4	6.5	2	2	24.6	0.35	1.7	0.96	1.63
HR 30311 DJ	7FB	75	67	110	94	114	4	10.5	2	2	37.0	0.83	0.73	0.40	1.58
HR 31311 J	7FB	75	67	110	94	114	4	10.5	2	2	37.0	0.83	0.73	0.40	1.58
HR 32311 J	2FD	73	67	110	99	111	4	10.5	2	2	29.9	0.35	1.7	0.96	2.39
HR 32311 CJ	5FD	73	65	110	91	112	4	10.5	2	2	35.8	0.55	1.1	0.60	2.47
HR 32912 J	2BC	69	65	79	78	81	4	3	1	1	15.5	0.33	1.8	1.0	0.306
HR 32012 XJ	4CC	71	66	86	85	91	4	5.5	1.5	1.5	20.9	0.43	1.4	0.77	0.608
HR 33012 J	2CE	71	66	86	85	90	5	6	1.5	1.5	20.0	0.33	1.8	1.0	0.713
HR 33112 J	3CE	71	68	91	88	96	5	7	1.5	1.5	23.6	0.40	1.5	0.83	0.91
HR 30212 J	3EB	72	69	101	96	103	4	4.5	2	1.5	22.0	0.41	1.5	0.81	0.930
HR 32212 J	3EC	72	68	101	95	104	4	5.5	2	1.5	24.1	0.41	1.5	0.81	1.18
HR 33212 J	3EE	72	68	101	94	105	6	9	2	1.5	27.6	0.40	1.5	0.82	1.56
T 7 FC060	7FC	78	72	111	94	119	4	11	2.5	2.5	41.4	0.82	0.73	0.40	2.03
HR 30312 J	2FB	78	77	118	112	120	4	7.5	2.5	2	26.0	0.35	1.7	0.96	2.03
HR 30312 DJ	7FB	84	74	118	103	125	4	11.5	2.5	2	40.3	0.83	0.73	0.40	1.98
HR 31312 J	7FB	84	74	118	103	125	4	11.5	2.5	2	40.3	0.83	0.73	0.40	1.98
HR 32312 J	2FD	81	74	118	107	120	4	11.5	2.5	2	31.4	0.35	1.7	0.96	2.96
32312 C	—	81	74	116	102	125	4	13.5	2.5	2	39.9	0.58	1.0	0.57	2.86
HR 32913 J	2BC	74	70	84	82	86	4	3	1	1	16.8	0.35	1.7	0.93	0.323
HR 32013 XJ	4CC	76	71	91	90	97	4	5.5	1.5	1.5	22.4	0.46	1.3	0.72	0.646
HR 33013 J	2CE	76	71	91	90	96	5	6	1.5	1.5	21.1	0.35	1.7	0.95	0.76
HR 33113 J	3DE	76	73	101	96	106	6	7.5	1.5	1.5	26.0	0.39	1.5	0.85	1.32
HR 30213 J	3EB	77	78	111	106	113	4	4.5	2	1.5	23.8	0.41	1.5	0.81	1.18
HR 32213 J	3EC	77	75	111	104	115	4	5.5	2	1.5	27.1	0.41	1.5	0.81	1.55
HR 33213 J	3EE	77	74	111	102	115	6	9	2	1.5	29.2	0.39	1.5	0.85	2.04
HR 30313 J	2GB	83	83	128	121	130	4	8	2.5	2	27.9	0.35	1.7	0.96	2.51
HR 30313 DJ	7GB	89	80	128	111	133	4	13	2.5	2	43.2	0.83	0.73	0.40	2.43
HR 31313 J	7GB	89	80	128	111	133	4	13	2.5	2	43.2	0.83	0.73	0.40	2.43
HR 32313 J	2GD	86	80	128	116	130	4	12	2.5	2	34.0	0.35	1.7	0.96	3.6

Remarks The suffix C represents medium-angle tapered roller bearings. Since they are designed for specific applications, please consult NSK when using bearings with suffix C.

Bore Diameter 70 – 80 mm

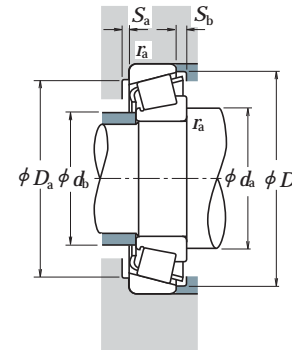
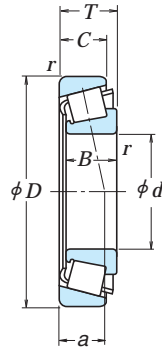

Dynamic Equivalent Load

$$P = XF_r + YF_a$$

$F_a / F_r \leq e$		$F_a / F_r > e$	
X	Y	X	Y
1	0	0.4	Y_1

Static Equivalent Load

$$P_0 = 0.5F_r + Y_0 F_a$$

When $F_r > 0.5F_r + Y_0 F_a$, use $P_0 = F_r$

The values of e , Y_1 , and Y_0 are given in the table below.

d	Boundary Dimensions (mm)				Cone r min.	Cup r min.	Basic Load Ratings (N) (kgf)				Limiting Speeds (min ⁻¹)	
	D	T	B	C			C _r	C _{0r}	C _r	C _{0r}	Grease	Oil
70	100	20	20	16	1	1	70 000	113 000	7 150	11 500	3 200	4 500
	110	25	25	19	1.5	1.5	104 000	158 000	10 600	16 100	3 200	4 300
	110	31	31	25.5	1.5	1.5	127 000	204 000	12 900	20 800	3 000	4 300
	120	37	37	29	2	1.5	177 000	262 000	18 100	26 700	3 000	4 000
	125	26.25	24	21	2	1.5	132 000	163 000	13 500	16 700	2 800	4 000
	125	33.25	31	27	2	1.5	157 000	205 000	16 100	20 900	2 800	4 000
	125	41	41	32	2	1.5	209 000	299 000	21 300	30 500	2 800	4 000
	140	39	35.5	27	3	3	177 000	229 000	18 000	23 400	2 400	3 400
	150	38	35	30	3	2.5	227 000	268 000	23 200	27 400	2 400	3 400
	150	38	35	25	3	2.5	192 000	229 000	19 600	23 300	2 200	3 200
	150	38	35	25	3	2.5	192 000	229 000	19 600	23 300	2 200	3 200
	150	54	51	42	3	2.5	300 000	390 000	30 500	39 500	2 600	3 400
150	54	51	42	3	2.5	280 000	390 000	28 600	39 500	2 400	3 400	
75	105	20	20	16	1	1	72 500	120 000	7 400	12 300	3 200	4 300
	115	25	25	19	1.5	1.5	109 000	171 000	11 100	17 400	3 000	4 000
	115	31	31	25.5	1.5	1.5	133 000	220 000	13 500	22 500	3 000	4 000
	125	37	37	29	2	2	182 000	275 000	18 600	28 100	2 800	3 800
	130	27.25	25	22	2	1.5	143 000	182 000	14 600	18 500	2 800	3 800
	130	33.25	31	27	2	1.5	165 000	219 000	16 900	22 400	2 800	3 800
	130	41	41	31	2	1.5	215 000	315 000	21 900	32 000	2 800	3 800
	160	40	37	31	3	2.5	253 000	300 000	25 800	30 500	2 400	3 200
	160	40	37	26	3	2.5	211 000	251 000	21 500	25 600	2 200	3 000
	160	40	37	26	3	2.5	211 000	251 000	21 500	25 600	2 200	3 000
	160	58	55	45	3	2.5	340 000	445 000	35 000	45 500	2 400	3 200
	160	58	55	43	3	2.5	310 000	420 000	32 000	43 000	2 200	3 200
80	110	20	20	16	1	1	75 000	128 000	7 650	13 100	3 000	4 000
	125	29	29	22	1.5	1.5	140 000	222 000	14 300	22 700	2 800	3 600
	125	36	36	29.5	1.5	1.5	172 000	282 000	17 500	28 800	2 800	3 600
	130	37	37	29	2	1.5	186 000	289 000	19 000	29 400	2 600	3 600
	140	28.25	26	22	2.5	2	157 000	195 000	16 000	19 900	2 600	3 400
	140	28.25	26	20	2.5	2	147 000	190 000	15 000	19 400	2 400	3 400
	140	35.25	33	28	2.5	2	192 000	254 000	19 600	25 900	2 600	3 400
	140	46	46	35	2.5	2	256 000	385 000	26 200	39 000	2 600	3 400
	170	42.5	39	33	3	2.5	276 000	330 000	28 200	33 500	2 200	3 000
	170	42.5	39	27	3	2.5	235 000	283 000	24 000	28 900	2 000	2 800
	170	42.5	39	27	3	2.5	235 000	283 000	24 000	28 900	2 000	2 800
	170	61.5	58	48	3	2.5	385 000	505 000	39 000	51 500	2 200	3 000
170	61.5	58	48	3	2.5	365 000	530 000	37 500	54 000	2 200	3 000	

Bearing Numbers	ISO355 Dimension Series approx.	Abutment and Fillet Dimensions (mm)						Cone r max.	Cup r max.	Eff. Load Centers (mm) a	Constant e	Axial Load Factors		Mass (kg) approx.	
		d _a min.	d _b max.	D _a max.	D _b min.	S _a min.	S _b min.					Y ₁	Y ₀		
HR 32914 J	2BC	79	76	94	93	96	4	4	1	1	17.6	0.32	1.9	1.1	0.494
HR 32014 XJ	4CC	81	77	101	98	105	5	6	1.5	1.5	23.7	0.43	1.4	0.76	0.869
HR 33014 J	2CE	81	78	101	100	105	5	5.5	1.5	1.5	22.2	0.28	2.1	1.2	1.11
HR 33114 J	3DE	82	79	111	104	115	6	8	2	1.5	27.9	0.38	1.6	0.87	1.71
HR 30214 J	3EB	82	81	116	110	118	4	5	2	1.5	25.6	0.42	1.4	0.79	1.3
HR 32214 J	3EC	82	80	116	108	119	4	6	2	1.5	28.6	0.42	1.4	0.79	1.66
HR 33214 J	3EE	82	78	116	107	120	7	9	2	1.5	30.4	0.41	1.5	0.81	2.15
T 7 FC070	7FC	88	79	126	106	133	5	12	2.5	2.5	46.4	0.87	0.69	0.38	2.55
HR 30314 J	2GB	88	89	138	132	140	4	8	2.5	2	29.7	0.35	1.7	0.96	3.03
HR 30314 DJ	7GB	94	85	138	118	142	4	13	2.5	2	45.8	0.83	0.73	0.40	2.94
HR 31314 J	7GB	94	85	138	118	142	4	13	2.5	2	45.8	0.83	0.73	0.40	2.94
HR 32314 J	2GD	91	86	138	124	140	4	12	2.5	2	36.1	0.35	1.7	0.96	4.35
HR 32314 CJ	5GD	91	84	138	115	141	4	12	2.5	2	43.3	0.55	1.1	0.60	4.47
HR 32915 J	2BC	84	81	99	98	101	4	4	1	1	18.7	0.33	1.8	0.99	0.53
HR 32015 XJ	4CC	86	82	106	103	110	5	6	1.5	1.5	25.1	0.46	1.3	0.72	0.925
HR 33015 J	2CE	86	83	106	104	110	6	5.5	1.5	1.5	23.0	0.30	2.0	1.1	1.18
HR 33115 J	3DE	87	83	115	109	120	6	8	2	2	29.2	0.40	1.5	0.83	1.8
HR 30215 J	4DB	87	85	121	115	124	4	5	2	1.5	27.0	0.44	1.4	0.76	1.43
HR 32215 J	4DC	87	84	121	113	125	4	6	2	1.5	29.8	0.44	1.4	0.76	1.72
HR 33215 J	3EE	87	83	121	111	125	7	10	2	1.5	31.6	0.43	1.4	0.77	2.25
HR 30315 J	2GB	93	95	148	141	149	4	9	2.5	2	31.8	0.35	1.7	0.96	3.63
HR 30315 DJ	7GB	99	91	148	129	152	6	14	2.5	2	48.8	0.83	0.73	0.40	3.47
HR 31315 J	7GB	99	91	148	129	152	6	14	2.5	2	48.8	0.83	0.73	0.40	3.47
HR 32315 J	2GD	96	91	148	134	149	4	13	2.5	2	38.9	0.35	1.7	0.96	5.31
32315 CA	—	96	90	148	124	153	4	15	2.5	2	47.7	0.58	1.0	0.57	5.3
HR 32916 J	2BC	89	85	104	102	106	4	4	1	1	19.8	0.35	1.7	0.94	0.56
HR 32016 XJ	3CC	91	89	116	112	120	6	7	1.5	1.5	26.9	0.42	1.4	0.78	1.32
HR 33016 J	2CE	91	88	116	112	119	6	6.5	1.5	1.5	25.5	0.28	2.2	1.2	1.66
HR 33116 J	3DE	82	88	121	113	126	6	8	2	1.5	30.4	0.42	1.4	0.79	1.88
HR 30216 J	3EB	95	91	130	124	132	4	6	2	2	28.1	0.42	1.4	0.79	1.68
30216 CA	—	95	92	130	122	133	4	8	2	2	33.8	0.58	1.0	0.57	1.66
HR 32216 J	3EC	95	90	130	122	134	4	7	2	2	30.6	0.42	1.4	0.79	2.13
HR 33216 J	3EE	95	89	130	119	135	7	11	2	2	34.8	0.43	1.4	0.78	2.93
HR 30316 J	2GB	98	102	158	150	159	4	9.5	2.5	2	34.0	0.35	1.7	0.96	4.27
HR 30316 DJ	7GB	104	97	158	136	159	6	15.5	2.5	2	51.8	0.83	0.73	0.40	4.07
HR 31316 J	7GB	104	97	158	136	159	6	15.5	2.5	2	51.8	0.83	0.73	0.40	4.07
HR 32316 J	2GD	101	98	158	143	159	4	13.5	2.5	2	41.4	0.35	1.7	0.96	6.35
HR 32316 CJ	5GD	101	95	158	132	160	4	13.5	2.5	2	49.3	0.55	1.1	0.60	6.59

Remarks The suffix CA represents medium-angle tapered roller bearings. Since they are designed for specific applications, please consult NSK when using bearings with suffix CA.

Bore Diameter 85 – 100 mm

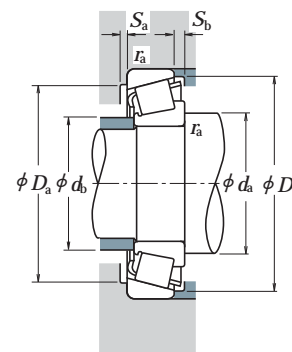
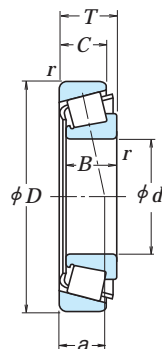

Dynamic Equivalent Load

$$P = XF_r + YF_a$$

$F_a/F_r \leq e$		$F_a/F_r > e$	
X	Y	X	Y
1	0	0.4	Y_1

Static Equivalent Load

$$P_0 = 0.5F_r + Y_0F_a$$

When $F_r > 0.5F_r + Y_0F_a$, use $P_0 = F_r$

The values of e , Y_1 , and Y_0 are given in the table below.

d	Boundary Dimensions (mm)				Cone		Basic Load Ratings				Limiting Speeds	
	D	T	B	C	r	r _{min}	(N)		(kgf)		Grease	Oil
							C _r	C _{0r}	C _r	C _{0r}		
85	120	23	23	18	1.5	1.5	93 500	157 000	9 550	16 000	2 800	3 800
	130	29	29	22	1.5	1.5	143 000	231 000	14 600	23 600	2 600	3 600
	130	36	36	29.5	1.5	1.5	180 000	305 000	18 400	31 000	2 600	3 600
	140	41	41	32	2.5	2	230 000	365 000	23 500	37 000	2 400	3 400
	150	30.5	28	24	2.5	2	184 000	233 000	18 700	23 800	2 400	3 200
	150	30.5	28	22	2.5	2	171 000	226 000	17 500	23 000	2 200	3 200
	150	38.5	36	30	2.5	2	210 000	277 000	21 400	28 200	2 200	3 200
	150	49	49	37	2.5	2	281 000	415 000	28 700	42 500	2 400	3 200
	180	44.5	41	34	4	3	310 000	375 000	31 500	38 000	2 000	2 800
	180	44.5	41	28	4	3	261 000	315 000	26 600	32 000	1 900	2 600
	180	44.5	41	28	4	3	261 000	315 000	26 600	32 000	1 900	2 600
	180	63.5	60	49	4	3	410 000	535 000	42 000	54 500	2 000	2 800
90	125	23	23	18	1.5	1.5	97 000	167 000	9 850	17 000	2 600	3 600
	140	32	32	24	2	1.5	170 000	273 000	17 300	27 800	2 400	3 200
	140	39	39	32.5	2	1.5	220 000	360 000	22 400	37 000	2 400	3 200
	150	45	45	35	2.5	2	259 000	405 000	26 500	41 500	2 400	3 200
	160	32.5	30	26	2.5	2	201 000	256 000	20 500	26 100	2 200	3 000
	160	42.5	40	34	2.5	2	256 000	350 000	26 100	35 500	2 200	3 000
	190	46.5	43	36	4	3	345 000	425 000	35 500	43 000	1 900	2 600
	190	46.5	43	30	4	3	264 000	315 000	26 900	32 000	1 800	2 400
	190	46.5	43	30	4	3	264 000	315 000	26 900	32 000	1 800	2 400
	190	67.5	64	53	4	3	450 000	590 000	46 000	60 500	2 000	2 600
95	130	23	23	18	1.5	1.5	98 000	172 000	10 000	17 500	2 400	3 400
	145	32	32	24	2	1.5	173 000	283 000	17 600	28 900	2 400	3 200
	145	39	39	32.5	2	1.5	231 000	390 000	23 500	39 500	2 400	3 200
	160	46	46	38	3	3	283 000	445 000	28 800	45 500	2 200	3 000
	170	34.5	32	27	3	2.5	223 000	286 000	22 800	29 200	2 200	2 800
	170	45.5	43	37	3	2.5	289 000	400 000	29 800	40 500	2 200	2 800
	200	49.5	45	38	4	3	370 000	455 000	38 000	46 500	1 900	2 600
	200	49.5	45	36	4	3	350 000	435 000	35 500	44 000	1 800	2 400
	200	49.5	45	32	4	3	310 000	375 000	31 500	38 500	1 700	2 400
	200	49.5	45	32	4	3	310 000	375 000	31 500	38 500	1 700	2 400
	200	71.5	67	55	4	3	525 000	710 000	53 500	72 500	1 900	2 600
100	140	25	25	20	1.5	1.5	117 000	205 000	12 000	20 900	2 200	3 200
	145	24	22.5	17.5	3	3	113 000	163 000	11 500	16 600	2 200	3 000
	150	32	32	24	2	1.5	176 000	294 000	17 900	30 000	2 200	3 000
	150	39	39	32.5	2	1.5	235 000	405 000	24 000	41 500	2 200	3 000
	165	52	52	40	2.5	2	315 000	515 000	32 500	52 500	2 000	2 800
	180	37	34	29	3	2.5	255 000	330 000	26 000	34 000	2 000	2 600
	180	49	46	39	3	2.5	325 000	450 000	33 000	46 000	2 000	2 600
	180	63	63	48	3	2.5	410 000	635 000	42 000	65 000	2 000	2 600
	215	51.5	47	39	4	3	425 000	525 000	43 000	53 500	1 700	2 400
	215	56.5	51	35	4	3	385 000	505 000	39 000	51 500	1 500	2 200
	215	77.5	73	60	4	3	565 000	755 000	57 500	77 000	1 700	2 400

Bearing Numbers	ISO355 Dimension Series approx.	Abutment and Fillet Dimensions (mm)						Cone		Eff. Load Centers (mm) a	Constant e	Axial Load Factors		Mass (kg) approx.	
		d _a min.	d _b max.	D _a max.	D _b min.	S _a min.	S _b min.	r _a min.	r _a max.			Y ₁	Y ₀		
HR 32917 J	2BC	96	92	111	111	115	5	5	1.5	1.5	20.9	0.33	1.8	1.0	0.8
HR 32017 XJ	4CC	96	94	121	116	125	6	7	1.5	1.5	28.2	0.44	1.4	0.75	1.38
HR 33017 J	2CE	96	94	121	117	125	6	6.5	1.5	1.5	26.5	0.29	2.1	1.1	1.75
HR 33117 J	3DE	100	94	130	122	135	7	9	2	2	32.7	0.41	1.5	0.81	2.51
HR 30217 J	3EB	100	97	140	133	141	5	6.5	2	2	30.3	0.42	1.4	0.79	2.12
30217 CA	—	100	98	140	131	142	5	8.5	2	2	36.2	0.58	1.0	0.57	2.07
HR 32217 J	3EC	100	96	140	131	142	5	8.5	2	2	33.9	0.42	1.4	0.79	2.64
HR 33217 J	3EE	100	95	140	129	144	7	12	2	2	37.3	0.42	1.4	0.79	3.57
HR 30317 J	2GB	106	108	166	157	167	5	10.5	3	2.5	35.8	0.35	1.7	0.96	5.08
HR 30317 DJ	7GB	113	103	166	144	169	6	16.5	3	2.5	55.4	0.83	0.73	0.40	4.88
HR 31317 J	7GB	113	103	166	144	169	6	16.5	3	2.5	55.4	0.83	0.73	0.40	4.88
HR 32317 J	2GD	110	104	166	151	167	5	14.5	3	2.5	43.6	0.35	1.7	0.96	7.31
HR 32918 J	2BC	101	97	116	116	120	5	5	1.5	1.5	22.0	0.34	1.8	0.96	0.838
HR 32018 XJ	3CC	102	99	131	124	134	6	8	2	1.5	29.7	0.42	1.4	0.78	1.78
HR 33018 J	2CE	102	99	131	129	135	7	6.5	2	1.5	27.9	0.27	2.2	1.2	2.21
HR 33118 J	3DE	105	100	140	132	144	7	10	2	2	35.2	0.40	1.5	0.83	3.14
HR 30218 J	3FB	105	103	150	141	150	5	6.5	2	2	31.7	0.42	1.4	0.79	2.6
HR 32218 J	3FC	105	102	150	139	152	5	8.5	2	2	36.2	0.42	1.4	0.79	3.41
HR 30318 J	2GB	111	114	176	176	176	5	10.5	3	2.5	37.3	0.35	1.7	0.96	5.91
HR 30318 DJ	7GB	118	110	176	152	179	6	16.5	3	2.5	58.7	0.83	0.73	0.40	5.52
HR 31318 J	7GB	118	110	176	152	179	6	16.5	3	2.5	58.7	0.83	0.73	0.40	5.52
HR 32318 J	2GD	115	109	176	158	177	5	14.5	3	2.5	46.5	0.35	1.7	0.96	8.6
HR 32919 J	2BC	106	102	121	121	125	5	5	1.5	1.5	23.2	0.36	1.7	0.92	0.877
HR 32019 XJ	4CC	107	104	136	131	140	6	8	2	1.5	31.2	0.44	1.4	0.75	1.88
HR 33019 J	2CE	107	103	136	133	139	7	6.5	2	1.5	28.6	0.28	2.2	1.2	2.3
T 2 ED095	2ED	113	108	146	141	152	6	8	2.5	2.5	34.5	0.34	1.8	0.97	3.74
HR 30219 J	3FB	113	110	158	150	159	5	7.5	2.5	2	33.7	0.42	1.4	0.79	3.13
HR 32219 J	3FC	113	108	158	147	161	5	8.5	2.5	2	39.3	0.42	1.4	0.79	4.22
HR 30319 J	2GB	116	119	186	172	184	5	11.5	3	2.5	38.6	0.35	1.7	0.96	6.92
30319 CA	—	116	119	186	168	188	5	13.5	3	2.5	48.6	0.54	1.1	0.61	6.71
HR 30319 DJ	7GB	123	115	186	158	187	6	17.5	3	2.5	61.9	0.83	0.73	0.40	6.64
HR 31319 J	7GB	123	115	186	158	187	6	17.5	3	2.5	61.9	0.83	0.73	0.40	6.64
HR 32319 J	2GD	120	115	186	167	186	5	16.5	3	2.5	48.6	0.35	1.7	0.96	10.4
HR 32920 J	2CC	111	109	132	132	134	5	5	1.5	1.5	24.2	0.33	1.8	1.0	1.18
T 4 CB100	4CB	118	108	135	135	142	6	6.5	2.5	2.5	30.1	0.47	1.3	0.70	1.18
HR 32020 XJ	4CC	112	109	141	136	144	6	8	2	1.5	32.5	0.46	1.3	0.72	1.95
HR 33020 J	2CE	112	107	141	137	143	7	6.5	2	1.5	29.3	0.29	2.1	1.2	2.38
HR 33120 J	3EE	115	110	155	144	159	8	12	2	2	40.5	0.41	1.5	0.81	4.32
HR 30220 J	3FB	118	116	168	158	168	5	8	2.5	2	36.1	0.42	1.4	0.79	3.78
HR 32220 J	3FC	118	115	168	155	171	5	10	2.5	2	41.5	0.42	1.4	0.79	5.05
HR 33220 J	3FE	118	113	168	152	172	10	15	2.5	2	46.0	0.40	1.5	0.82	6.76
HR 30320 J	2GB	121	128	201	185	197	5	12.5	3	2.5	41.4	0.35	1.7	0.96	

Bore Diameter 105 – 130 mm

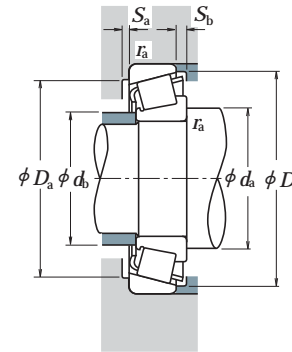
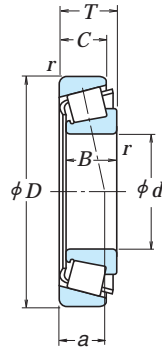

Dynamic Equivalent Load

$$P = XF_r + YF_a$$

F_a/F_r	e	F_a/F_r	e
X	Y	X	Y
1	0	0.4	Y_1

Static Equivalent Load

$$P_0 = 0.5F_r + Y_0F_a$$

When $F_r < 0.5F_r + Y_0F_a$, use $P_0 = F_r$

The values of e , Y_1 , and Y_0 are given in the table below.

Boundary Dimensions (mm)							Basic Load Ratings				Limiting Speeds	
d	D	T	B	C	Cone	Cup	(N)		(kgf)		(min ⁻¹)	
					r	r	C_r	C_{0r}	C_r	C_{0r}	Grease	Oil
					min.	min.						
105	145	25	25	20	1.5	1.5	119 000	212 000	12 100	21 600	2 200	3 000
	160	35	35	26	2.5	2	204 000	340 000	20 800	34 500	2 000	2 800
	160	43	43	34	2.5	2	256 000	435 000	26 100	44 000	2 000	2 800
	190	39	36	30	3	2.5	280 000	365 000	28 500	37 500	1 900	2 600
	190	53	50	43	3	2.5	360 000	510 000	37 000	52 000	1 900	2 600
	225	53.5	49	41	4	3	455 000	565 000	46 500	57 500	1 600	2 200
	225	58	53	36	4	3	415 000	540 000	42 000	55 000	1 500	2 000
	225	81.5	77	63	4	3	670 000	925 000	68 000	94 500	1 700	2 200
110	150	25	25	20	1.5	1.5	123 000	224 000	12 500	22 800	2 200	2 800
	170	38	38	29	2.5	2	236 000	390 000	24 000	40 000	2 000	2 600
	170	47	47	37	2.5	2	294 000	515 000	30 000	52 500	2 000	2 600
	180	56	56	43	2.5	2	365 000	610 000	37 500	62 000	1 900	2 600
	200	41	38	32	3	2.5	315 000	420 000	31 500	43 000	1 800	2 400
	200	56	53	46	3	2.5	400 000	565 000	40 500	57 500	1 800	2 400
	240	54.5	50	42	4	3	485 000	595 000	49 500	60 500	1 500	2 000
	240	63	57	38	4	3	470 000	605 000	48 000	62 000	1 400	1 900
120	165	29	29	23	1.5	1.5	161 000	291 000	16 400	29 700	1 900	2 600
	170	27	25	19.5	3	3	153 000	243 000	15 600	24 800	1 800	2 600
	180	38	38	29	2.5	2	242 000	405 000	24 600	41 000	1 800	2 400
	180	48	48	38	2.5	2	300 000	540 000	30 500	55 000	1 800	2 600
	200	62	62	48	2.5	2	460 000	755 000	46 500	77 000	1 700	2 400
	215	43.5	40	34	3	2.5	335 000	450 000	34 000	46 000	1 600	2 200
	215	61.5	58	50	3	2.5	440 000	635 000	44 500	65 000	1 600	2 200
	260	59.5	55	46	4	3	535 000	655 000	54 500	67 000	1 400	1 900
130	180	32	30	26	2	1.5	167 000	281 000	17 000	28 600	1 800	2 400
	180	32	32	25	2	1.5	200 000	365 000	20 400	37 500	1 800	2 400
	185	29	27	21	3	3	183 000	296 000	18 600	30 000	1 700	2 400
	200	45	45	34	2.5	2	320 000	535 000	32 500	54 500	1 600	2 200
	200	55	55	43	2.5	2	395 000	715 000	40 500	73 000	1 700	2 200
	230	43.75	40	34	4	3	375 000	505 000	38 000	51 500	1 500	2 000
	230	67.75	64	54	4	3	530 000	790 000	54 000	80 500	1 500	2 000
	280	63.75	58	49	5	4	545 000	675 000	56 000	68 500	1 300	1 800
130	280	63.75	58	49	5	4	650 000	820 000	66 000	83 500	1 300	1 800
	280	72	66	44	5	4	625 000	820 000	63 500	83 500	1 200	1 700
	280	98.75	93	78	5	4	830 000	1 150 000	84 500	117 000	1 300	1 800

Bearing Numbers	ISO355 Dimension Series approx.	Abutment and Fillet Dimensions (mm)								Eff. Load Centers (mm) a	Constant e	Axial Load Factors		Mass (kg) approx.	
		d_a min.	d_b max.	D_a max.	D_b min.	S_a min.	S_b min.	Cone r_a max.	Cup r_a min.			Y_1	Y_0		
HR 32921 J	2CC	116	114	137	137	140	5	5	1.5	1.5	25.3	0.34	1.8	0.96	1.23
HR 32021 XJ	4DC	120	115	150	144	154	6	9	2	2	34.3	0.44	1.4	0.74	2.48
HR 33021 J	2DE	120	115	150	146	153	7	9	2	2	30.9	0.28	2.1	1.2	3.03
HR 30221 J	3FB	123	123	178	166	177	6	9	2.5	2	38.1	0.42	1.4	0.79	4.51
HR 32221 J	3FC	123	120	178	162	180	5	10	2.5	2	44.8	0.42	1.4	0.79	6.25
HR 30321 J	2GB	126	133	211	195	206	6	12.5	3	2.5	43.3	0.35	1.7	0.96	9.52
HR 31321 J	7GB	141	130	211	177	211	7	22	3	2.5	70.2	0.83	0.73	0.40	10
HR 32321 J	2GD	130	129	211	186	209	6	18.5	3	2.5	55.2	0.35	1.7	0.96	14.9
HR 32922 J	2CC	121	119	142	142	145	5	5	1.5	1.5	26.5	0.36	1.7	0.93	1.29
HR 32022 XJ	4DC	125	121	160	153	163	7	9	2	2	35.9	0.43	1.4	0.77	3.09
HR 33022 J	2DE	125	121	160	153	161	7	10	2	2	33.7	0.29	2.1	1.2	3.84
HR 33122 J	3EE	125	121	170	156	174	9	13	2	2	44.1	0.42	1.4	0.79	5.54
HR 32222 J	3FB	128	129	188	175	187	6	9	2.5	2	40.2	0.42	1.4	0.79	5.28
HR 32222 J	3FC	128	127	188	171	190	5	10	2.5	2	47.2	0.42	1.4	0.79	7.35
HR 30322 J	2GB	131	143	226	208	220	6	12.5	3	2.5	45.1	0.35	1.7	0.96	11
HR 31322 J	7GB	146	136	226	191	224	7	25	3	2.5	74.8	0.83	0.73	0.40	12.3
HR 32322 J	2GD	135	139	226	201	222	6	19.5	3	2.5	58.6	0.35	1.7	0.96	17.1
HR 32924 J	2CC	131	129	156	155	160	6	6	1.5	1.5	29.2	0.35	1.7	0.95	1.8
T 4 CB120	4CB	138	129	158	158	164	7	7.5	2.5	2.5	35.0	0.47	1.3	0.70	1.78
HR 32024 XJ	4DC	135	131	170	162	173	7	9	2	2	39.7	0.46	1.3	0.72	3.27
HR 33024 J	2DE	135	130	168	161	171	6	10	2	2	36.0	0.31	2.0	1.1	4.2
HR 33124 J	3FE	135	133	190	173	192	9	14	2	2	47.9	0.40	1.5	0.83	7.67
HR 30224 J	4FB	138	141	203	190	201	6	9.5	2.5	2	44.4	0.44	1.4	0.76	6.28
HR 32224 J	4FD	138	137	203	181	204	6	11.5	2.5	2	52.1	0.44	1.4	0.76	9.0
HR 30324 J	2GB	141	154	246	223	237	6	13.5	3	2.5	50.0	0.35	1.7	0.96	13.9
HR 31324 J	7GB	156	148	246	206	244	9	26	3	2.5	81.7	0.83	0.73	0.40	15.6
HR 32324 J	2GD	145	149	246	216	239	6	21.5	3	2.5	62.5	0.35	1.7	0.96	21.8
32926	—	142	141	171	168	175	6	6	2	1.5	34.7	0.36	1.7	0.92	2.25
HR 32926 J	2CC	142	140	170	168	173	6	7	2	1.5	31.4	0.34	1.8	0.97	2.46
T 4 CB130	4CB	148	141	171	171	179	8	8	2.5	2.5	37.5	0.47	1.3	0.70	2.32
HR 32026 XJ	4EC	145	144	190	179	192	8	11	2	2	43.9	0.43	1.4	0.76	5.06
HR 33026 J	2EE	145	144	188	179	192	8	12	2	2	42.4	0.34	1.8	0.97	6.25
HR 30226 J	4FB	151	151	216	205	217	7	9.5	3	2.5	45.9	0.44	1.4	0.76	7.25
HR 32226 J	4FD	151	147	216	196	219	7	13.5	3	2.5	57.0	0.44	1.4	0.76	11.3
30326	—	157	168	262	239	255	8	14.5	4	3	53.9	0.36	1.7	0.92	16.6
HR 30326 J	2GB	157	166	262	241	255	8	14.5	4	3	52.8	0.35	1.7	0.96	17.2
HR 31326 J	7GB	174	159	262	220	261	9	28	4	3	87.1	0.83	0.73	0.40	18.8
32326	—	162	165	262	233	263	8	20.5	4	3	69.2	0.36	1.7	0.92	26.6

Bore Diameter 140 – 170 mm

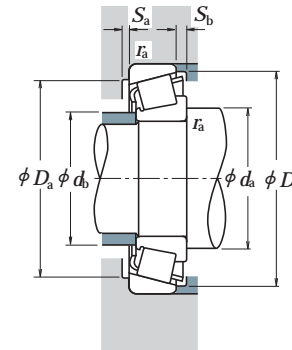
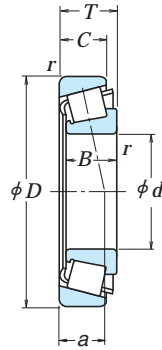

Dynamic Equivalent Load

$$P = X F_r + Y F_a$$

$F_a / F_r \leq e$		$F_a / F_r > e$	
X	Y	X	Y
1	0	0.4	Y_1

Static Equivalent Load

$$P_0 = 0.5 F_r + Y_0 F_a$$

When $F_r > 0.5 F_r + Y_0 F_a$, use $P_0 = F_r$

The values of e , Y_1 , and Y_0 are given in the table below.

d	Boundary Dimensions (mm)				Cone		Basic Load Ratings				Limiting Speeds		
	D	T	B	C	r	Cup min.	C_r	C_{0r}	C_r	C_{0r}	Grease	Oil	
140	190	32	32	25	2	1.5	206 000	390 000	21 000	39 500	1 700	2 200	
	210	45	45	34	2.5	2	325 000	555 000	33 000	57 000	1 600	2 200	
	210	56	56	44	2.5	2	410 000	770 000	42 000	78 500	1 600	2 200	
	250	45.75	42	36	4	3	390 000	515 000	40 000	52 500	1 400	1 900	
	250	71.75	68	58	4	3	610 000	915 000	62 000	93 500	1 400	1 900	
	300	67.75	62	53	5	4	740 000	945 000	75 500	96 500	1 200	1 700	
	300	77	70	47	5	4	695 000	955 000	71 000	97 500	1 100	1 500	
	300	107.75	102	85	5	4	985 000	1 440 000	101 000	147 000	1 200	1 600	
	150	210	38	36	31	2.5	2	247 000	440 000	25 200	45 000	1 500	2 000
		210	38	38	30	2.5	2	281 000	520 000	28 600	53 000	1 500	2 000
		225	48	48	36	3	2.5	375 000	650 000	38 000	66 500	1 400	2 000
		225	59	59	46	3	2.5	435 000	805 000	44 000	82 000	1 400	2 000
270		49	45	38	4	3	485 000	665 000	49 000	67 500	1 300	1 800	
270		77	73	60	4	3	705 000	1 080 000	71 500	110 000	1 300	1 800	
320		72	65	55	5	4	690 000	860 000	70 000	87 500	1 100	1 500	
320		72	65	55	5	4	825 000	1 060 000	84 500	108 000	1 100	1 600	
320		82	75	50	5	4	790 000	1 100 000	80 500	112 000	1 000	1 400	
320		114	108	90	5	4	1 120 000	1 700 000	114 000	174 000	1 100	1 500	
160		220	38	38	30	2.5	2	296 000	570 000	30 000	58 000	1 400	1 900
		240	51	51	38	3	2.5	425 000	750 000	43 500	76 500	1 300	1 800
	290	52	48	40	4	3	530 000	730 000	54 000	74 500	1 200	1 600	
	290	84	80	67	4	3	795 000	1 220 000	81 000	125 000	1 200	1 600	
	340	75	68	58	5	4	765 000	960 000	78 000	98 000	1 000	1 400	
	340	75	68	58	5	4	870 000	1 110 000	89 000	113 000	1 100	1 400	
	340	75	68	48	5	4	675 000	875 000	69 000	89 000	950	1 300	
	340	121	114	95	5	4	1 210 000	1 770 000	123 000	181 000	1 000	1 400	
	170	230	38	36	31	2.5	2.5	258 000	485 000	26 300	49 500	1 300	1 800
		230	38	38	30	2.5	2	294 000	560 000	30 000	57 000	1 400	1 800
		260	57	57	43	3	2.5	505 000	890 000	51 500	90 500	1 200	1 700
		310	57	52	43	5	4	630 000	885 000	64 000	90 000	1 100	1 500
310		91	86	71	5	4	930 000	1 450 000	94 500	148 000	1 100	1 500	
360		80	72	62	5	4	845 000	1 080 000	86 000	110 000	950	1 300	
360		80	72	62	5	4	960 000	1 230 000	98 000	125 000	1 000	1 300	
360		80	72	50	5	4	760 000	1 040 000	77 500	106 000	900	1 200	
360		127	120	100	5	4	1 370 000	2 050 000	140 000	209 000	1 000	1 300	

Bearing Numbers	ISO355 Dimension Series approx.	Abutment and Fillet Dimensions (mm)								Cone Cup r_a max.	Eff. Load Centers (mm) a	Constant e	Axial Load Factors		Mass (kg) approx.
		d_a min.	d_b max.	D_a max.	D_b min.	S_a min.	S_b min.	Y_1	Y_0						
HR 32928 J HR 32028 XJ HR 33028 J	2CC	152	150	180	178	184	6	7	2	1.5	33.6	0.36	1.7	0.92	2.64
	4DC	155	152	200	189	202	8	11	2	2	46.6	0.46	1.3	0.72	5.32
	2DE	155	153	198	189	202	7	12	2	2	45.5	0.36	1.7	0.92	6.74
HR 30228 J HR 32228 J HR 30328 J	4FB	161	164	236	221	234	7	9.5	3	2.5	48.9	0.44	1.4	0.76	8.74
	4FD	161	159	236	213	238	9	13.5	3	2.5	60.5	0.44	1.4	0.76	14.3
	2GB	167	177	282	256	273	9	14.5	4	3	55.7	0.35	1.7	0.96	21.1
HR 31328 J 32328	7GB	184	174	282	236	280	9	30	4	3	92.9	0.83	0.73	0.40	28.5
	—	172	177	282	246	281	9	22.5	4	3	76.4	0.37	1.6	0.88	33.9
32930 HR 32930 J HR 32030 XJ	—	165	162	200	195	201	7	7	2	2	36.7	0.33	1.8	1.0	3.8
	2DC	165	163	198	196	202	7	8	2	2	36.5	0.33	1.8	1.0	4.05
	4EC	168	164	213	202	216	8	12	2.5	2	49.8	0.46	1.3	0.72	6.6
HR 33030 J HR 30230 J HR 32230 J	2EE	168	165	213	203	217	8	13	2.5	2	48.7	0.36	1.7	0.90	8.07
	2GB	171	175	256	236	250	7	11	3	2.5	51.3	0.44	1.4	0.76	11.2
	4GD	171	171	256	228	254	8	17	3	2.5	64.7	0.44	1.4	0.76	17.8
30330 HR 30330 J HR 31330 J 32330	—	177	193	302	275	292	8	17	4	3	61.4	0.36	1.7	0.92	24.2
	2GB	177	190	302	276	292	8	17	4	3	60.0	0.35	1.7	0.96	25
	7GB	194	187	302	253	300	9	32	4	3	99.3	0.83	0.73	0.40	28.5
32330	—	182	191	302	262	297	8	24	4	3	81.5	0.37	1.6	0.88	41.4
HR 32932 J HR 32032 XJ HR 30232 J	2DC	175	173	208	206	212	7	8	2	2	38.7	0.35	1.7	0.95	4.32
	4EC	178	175	228	216	231	8	13	2.5	2	53.0	0.46	1.3	0.72	7.93
	4GB	181	189	276	253	269	8	12	3	2.5	55.0	0.44	1.4	0.76	13.7
HR 32232 J 30332 HR 30332 J	4GD	181	184	276	243	274	10	17	3	2.5	70.5	0.44	1.4	0.76	22.7
	—	187	205	322	293	311	10	17	4	3	64.6	0.36	1.7	0.92	28.4
	2GB	187	201	322	293	310	10	17	4	3	62.9	0.35	1.7	0.96	29.2
30332 D 32332	—	196	198	322	270	313	9	27	4	3	99.4	0.81	0.74	0.41	27.5
	—	192	202	322	281	319	10	26	4	3	87.1	0.37	1.6	0.88	48.3
32934 HR 32934 J HR 32034 XJ	—	185	183	220	216	223	7	7	2	2	41.6	0.36	1.7	0.90	4.3
	3DC	185	180	218	215	222	7	8	2	2	41.7	0.38	1.6	0.86	4.44
	4EC	188	187	248	232	249	10	14	2.5	2	56.6	0.44	1.4	0.74	10.6
HR 30234 J HR 32234 J 30334	4GB	197	202	292	273	288	8	14	4	3	59.4	0.44	1.4	0.76	17.1
	4GD	197	197	292	262	294	10	20	4	3	76.4	0.44	1.4	0.76	28
	—	197	221	342	312	332	10	18	4	3	70.1	0.37	1.6	0.90	33.5
HR 30334 J 30334 D 32334	2GB	197	214	342	310	329	10	18	4	3	67.3	0.35	1.7	0.96	34.5
	—	206	215	342	288	332	10	30	4	3	107.3	0.81	0.74	0.41	33.4
	—	202	213	342	297	337	10	27	4	3	91.3	0.37	1.6	0.88	57

Bore Diameter 180 – 240 mm

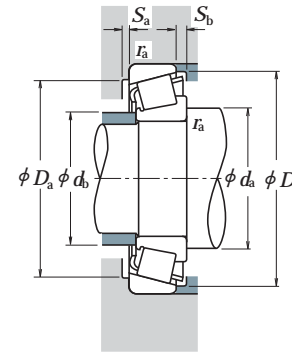
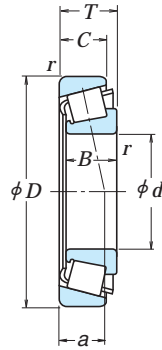

Dynamic Equivalent Load

$$P = XF_r + YF_a$$

$F_a/F_r \leq e$		$F_a/F_r > e$	
X	Y	X	Y
1	0	0.4	Y_1

Static Equivalent Load

$$P_0 = 0.5F_r + Y_0F_a$$

When $F_r > 0.5F_r + Y_0F_a$, use $P_0 = F_r$

The values of e , Y_1 , and Y_0 are given in the table below.

Boundary Dimensions (mm)							Basic Load Ratings				Limiting Speeds		
d	D	T	B	C	Cone r	Cup r	(N)		(kgf)		(min ⁻¹)		
							C_r	C_{Or}	C_r	C_{Or}	Grease	Oil	
180	250	45	45	34	2.5	2	350 000	685 000	36 000	69 500	1 300	1 700	
	280	64	64	48	3	2.5	640 000	1 130 000	65 000	115 000	1 200	1 600	
	320	57	52	43	5	4	650 000	930 000	66 000	95 000	1 100	1 400	
	320	91	86	71	5	4	960 000	1 540 000	98 000	157 000	1 100	1 400	
	380	83	75	64	5	4	935 000	1 230 000	95 500	126 000	900	1 300	
	380	83	75	53	5	4	820 000	1 120 000	83 500	114 000	850	1 200	
	380	134	126	106	5	4	1 520 000	2 290 000	155 000	234 000	950	1 300	
	190	260	45	45	34	2.5	2	365 000	715 000	37 000	73 000	1 200	1 600
	290	64	64	48	3	2.5	650 000	1 170 000	66 000	119 000	1 100	1 500	
	340	60	55	46	5	4	715 000	1 020 000	73 000	104 000	1 000	1 300	
200	340	97	92	75	5	4	1 110 000	1 770 000	113 000	181 000	1 000	1 400	
	400	86	78	65	6	5	1 010 000	1 340 000	103 000	136 000	850	1 200	
	400	140	132	109	6	5	1 660 000	2 580 000	169 000	263 000	850	1 200	
	280	51	48	41	3	2.5	410 000	780 000	42 000	80 000	1 100	1 500	
	280	51	51	39	3	2.5	480 000	935 000	48 500	95 000	1 100	1 500	
	310	70	70	53	3	2.5	760 000	1 370 000	77 500	139 000	1 000	1 400	
	360	64	58	48	5	4	795 000	1 120 000	81 000	114 000	950	1 300	
	360	104	98	82	5	4	1 210 000	1 920 000	123 000	196 000	950	1 300	
	420	89	80	67	6	5	1 030 000	1 390 000	105 000	142 000	850	1 200	
	420	146	138	115	6	5	1 820 000	2 870 000	185 000	292 000	800	1 100	
220	300	51	51	39	3	2.5	490 000	990 000	50 000	101 000	1 000	1 400	
	340	76	76	57	4	3	885 000	1 610 000	90 500	164 000	950	1 300	
	400	72	65	54	5	4	810 000	1 150 000	82 500	117 000	850	1 100	
	400	114	108	90	5	4	1 340 000	2 210 000	137 000	225 000	850	1 100	
	460	97	88	73	6	5	1 430 000	1 990 000	146 000	203 000	750	1 000	
	460	154	145	122	6	5	2 020 000	3 200 000	206 000	325 000	750	1 000	
	240	320	51	51	39	3	2.5	500 000	1 040 000	51 000	107 000	950	1 300
	360	76	76	57	4	3	920 000	1 730 000	94 000	177 000	850	1 200	
	440	79	72	60	5	4	990 000	1 400 000	101 000	142 000	750	1 000	
	440	127	120	100	5	4	1 630 000	2 730 000	166 000	278 000	750	1 000	
500	105	95	80	6	5	1 660 000	2 340 000	169 000	238 000	670	950		
500	165	155	132	6	5	2 520 000	4 100 000	257 000	415 000	670	900		

Bearing Numbers	ISO355 Dimension Series approx.	Abutment and Fillet Dimensions (mm)								Eff. Load Centers (mm) a	Constant e	Axial Load Factors		Mass (kg) approx.		
		d_a min.	d_b max.	D_a max.	D_b min.	S_a min.	S_b min.	Cone r_a max.	Cup r_a min.			Y_1	Y_0			
HR 32936 J HR 32036 XJ HR 30236 J	4DC	195	192	240	227	241	8	11	2	2	53.9	0.48	1.3	0.69	6.56	
	3FD	198	199	268	248	267	10	16	2.5	2	60.4	0.42	1.4	0.78	14.3	
	4GB	207	210	302	281	297	9	14	4	3	61.8	0.45	1.3	0.73	17.8	
HR 32236 J 30336 30336 D 32336	4GD	207	205	302	270	303	10	20	4	3	78.9	0.45	1.3	0.73	29.8	
	—	207	233	362	324	345	10	19	4	3	72.5	0.36	1.7	0.92	39.3	
	—	216	229	362	304	352	10	30	4	3	113.1	0.81	0.74	0.41	38.5	
	—	212	225	362	310	353	10	28	4	3	96.6	0.37	1.6	0.88	66.8	
HR 32938 J HR 32038 XJ HR 30238 J	4DC	205	201	250	237	251	8	11	2	2	55.3	0.48	1.3	0.69	6.83	
	4FD	208	209	278	258	279	10	16	2.5	2	63.4	0.44	1.4	0.75	14.9	
	4GB	217	223	322	302	318	9	14	4	3	65.6	0.44	1.4	0.76	21.4	
HR 32238 J 30338 32338	4GD	217	216	322	290	323	10	22	4	3	80.5	0.44	1.4	0.76	35.2	
	—	223	248	378	346	366	11	21	5	4	76.1	0.36	1.7	0.92	46	
	—	229	243	378	332	375	11	31	5	4	102.7	0.37	1.6	0.88	78.9	
32940 HR 32940 J HR 32040 XJ	—	218	217	268	256	269	9	10	2.5	2	53.4	0.37	1.6	0.88	9.26	
	3EC	218	216	268	258	271	9	12	2.5	2	54.2	0.39	1.5	0.84	9.65	
	4FD	218	221	298	277	297	11	17	2.5	2	67.4	0.43	1.4	0.77	18.9	
HR 30240 J HR 32240 J 30340	4GB	227	236	342	318	336	10	16	4	3	69.1	0.44	1.4	0.76	25.5	
	3GD	227	230	342	305	340	11	22	4	3	85.1	0.41	1.5	0.81	42.6	
	—	233	253	398	346	368	11	22	5	4	81.4	0.37	1.6	0.88	52.3	
30340 D 32340	—	244	253	398	336	385	11	33	5	4	122.9	0.81	0.74	0.41	49.6	
	—	239	253	398	346	392	11	31	5	4	106.7	0.37	1.6	0.88	90.9	
	HR 32944 J HR 32044 XJ 30244	3EC	238	235	288	278	293	9	12	2.5	2	59.2	0.43	1.4	0.78	10.3
32244 30344 32344	4FD	241	244	326	303	326	12	19	3	2.5	73.6	0.43	1.4	0.77	24.4	
	—	247	267	382	350	367	11	18	4	3	74.7	0.40	1.5	0.82	33.6	
	—	247	260	382	340	377	12	24	4	3	93.0	0.40	1.5	0.82	57.4	
	—	253	283	438	390	414	12	24	5	4	85.4	0.36	1.7	0.92	72.4	
32344	—	259	274	438	372	421	12	32	5	4	114.9	0.37	1.6	0.88	114	
	HR 32948 J HR 32048 XJ 30248	4EC	258	255	308	297	314	9	12	2.5	2	65.1	0.46	1.3	0.72	11.1
	4FD	261	262	346	321	346	12	19	3	2.5	79.1	0.46	1.3	0.72	26.2	
32248 30348 32348	—	267	288	422	384	408	11	19	4	3	85.1	0.44	1.4	0.74	45.2	
	—	267	285	422	374	416	12	27	4	3	102.5	0.40	1.5	0.82	78	
	—	273	308	478	422	447	12	25	5	4	92.8	0.36	1.7	0.92	92.6	
	—	279	301	478	410	464	12	33	5	4	123.2	0.37	1.6	0.88	145	

Bore Diameter 260 – 440 mm

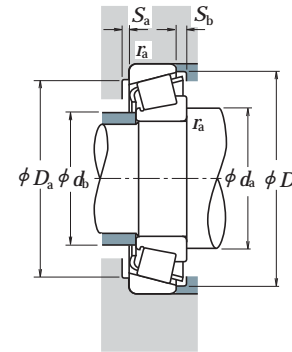
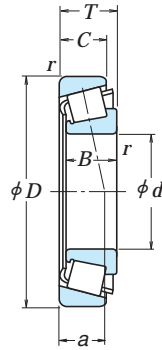

Dynamic Equivalent Load

$$P = X F_r + Y F_a$$

$F_a / F_r \leq e$		$F_a / F_r > e$	
X	Y	X	Y
1	0	0.4	Y_1

Static Equivalent Load

$$P_0 = 0.5 F_r + Y_0 F_a$$

When $F_r > 0.5 F_r + Y_0 F_a$, use $P_0 = F_r$

The values of e , Y_1 , and Y_0 are given in the table below.

d	Boundary Dimensions (mm)				Cone r min.	Cup r	Basic Load Ratings (N) (kgf)				Limiting Speeds (min ⁻¹)	
	D	T	B	C			C _r	C _{0r}	C _r	C _{0r}	Grease	Oil
260	360	63.5	63.5	48	3	2.5	730 000	1 450 000	74 500	148 000	850	1 100
	400	87	87	65	5	4	1 160 000	2 160 000	118 000	220 000	800	1 100
	480	89	80	67	6	5	1 190 000	1 700 000	121 000	174 000	670	900
	480	137	130	106	6	5	1 900 000	3 300 000	194 000	335 000	670	950
280	540	113	102	85	6	6	1 870 000	2 640 000	190 000	269 000	630	850
	540	176	165	136	6	6	2 910 000	4 800 000	297 000	490 000	630	850
	380	63.5	63.5	48	3	2.5	765 000	1 580 000	78 000	162 000	800	1 100
	420	87	87	65	5	4	1 180 000	2 240 000	120 000	228 000	710	1 000
300	500	89	80	67	6	5	1 240 000	1 900 000	127 000	194 000	630	850
	500	137	130	106	6	5	1 950 000	3 450 000	199 000	355 000	630	850
	580	187	175	145	6	6	3 300 000	5 400 000	335 000	550 000	560	800
	420	76	72	62	4	3	895 000	1 820 000	91 000	186 000	710	950
320	420	76	76	57	4	3	1 010 000	2 100 000	103 000	214 000	710	950
	460	100	100	74	5	4	1 440 000	2 700 000	147 000	275 000	670	900
	540	96	85	71	6	5	1 440 000	2 100 000	147 000	214 000	600	800
	540	149	140	115	6	5	2 220 000	3 700 000	226 000	380 000	600	800
340	440	76	72	63	4	3	900 000	1 880 000	92 000	192 000	970	900
	440	76	76	57	4	3	1 040 000	2 220 000	106 000	227 000	670	900
	480	100	100	74	5	4	1 510 000	2 910 000	153 000	297 000	630	850
	580	104	92	75	6	5	1 640 000	2 420 000	168 000	247 000	530	750
360	580	159	150	125	6	5	2 860 000	5 050 000	292 000	515 000	530	750
	670	210	200	170	7.5	7.5	4 200 000	7 100 000	430 000	725 000	480	670
	460	76	72	63	4	3	910 000	1 940 000	93 000	197 000	630	850
	460	76	76	57	4	3	1 050 000	2 220 000	107 000	226 000	630	850
380	520	112	106	92	6	5	1 650 000	3 400 000	168 000	345 000	560	750
	480	76	72	62	4	3	945 000	2 100 000	96 500	214 000	600	800
	480	76	76	57	4	3	1 080 000	2 340 000	110 000	239 000	560	800
	540	112	106	92	6	5	1 680 000	3 500 000	171 000	355 000	530	750
400	520	87	82	71	5	4	1 210 000	2 550 000	124 000	260 000	560	750
	540	87	82	71	5	4	1 250 000	2 700 000	128 000	276 000	530	710
420	600	125	118	100	6	5	1 960 000	4 050 000	200 000	415 000	480	670
	560	87	82	72	5	4	1 300 000	2 810 000	132 000	287 000	500	670
440	620	125	118	100	6	5	2 000 000	4 200 000	204 000	430 000	450	630
	650	130	122	104	6	6	2 230 000	4 600 000	227 000	470 000	430	600

Bearing Numbers	ISO355 Dimension Series approx.	Abutment and Fillet Dimensions (mm)								Cone r max.	Cup r max.	Eff. Load Centers (mm) a	Constant e	Axial Load Factors		Mass (kg) approx.
		d _a min.	d _b max.	D _a max.	D _b min.	S _a min.	S _b min.	Y ₁	Y ₀							
HR 32952 J HR 32052 XJ 30252	3EC	278	278	348	333	347	11	15.5	2.5	2	69.8	0.41	1.5	0.81	18.6	
	4FC	287	287	382	357	383	14	22	4	3	86.3	0.43	1.4	0.76	38.5	
	—	293	316	458	421	447	12	22	5	4	94.6	0.44	1.4	0.74	60.7	
32252 30352 32352	—	293	305	458	394	446	14	31	5	4	116.0	0.45	1.3	0.73	103	
	—	293	336	512	460	487	16	28	5	5	101.6	0.36	1.7	0.92	114	
	—	293	328	512	441	495	13	40	5	5	130.5	0.37	1.6	0.88	188	
HR 32956 J HR 32056 XJ 30256	4EC	298	297	368	352	368	12	15.5	2.5	2	75.3	0.43	1.4	0.76	20	
	4FC	307	305	402	374	402	14	22	4	3	91.6	0.46	1.3	0.72	40.6	
	—	313	339	478	436	462	12	22	5	4	98.5	0.44	1.4	0.74	66.3	
32256 32356	—	313	325	478	412	467	14	31	5	4	123.1	0.47	1.3	0.70	109	
	—	319	353	552	475	532	14	42	5	5	139.6	0.37	1.6	0.89	224	
	—	321	326	406	386	405	13	14	3	2.5	79.3	0.37	1.6	0.88	30.5	
HR 32960 J HR 32060 XJ	3FD	321	324	406	387	405	13	19	3	2.5	79.9	0.39	1.5	0.84	31.4	
	4GD	327	330	442	408	439	15	26	4	3	98.4	0.43	1.4	0.76	56.6	
	—	333	355	518	470	499	14	25	5	4	105.1	0.44	1.4	0.74	80.6	
30260 32260	—	333	352	518	458	514	15	34	5	4	131.7	0.46	1.3	0.72	132	
	—	341	345	426	404	425	13	13	3	2.5	84.3	0.39	1.5	0.84	32	
	—	341	344	426	406	426	13	19	3	2.5	85.0	0.42	1.4	0.79	33.3	
HR 32964 J HR 32064 XJ	3FD	341	344	426	406	426	13	19	3	2.5	85.0	0.42	1.4	0.79	33.3	
	4GD	347	350	462	430	461	15	26	4	3	104.5	0.46	1.3	0.72	60	
	—	353	381	558	503	533	14	29	5	4	113.7	0.44	1.4	0.74	99.3	
30264 32264 32364	—	353	383	558	487	550	15	34	5	4	141.7	0.46	1.3	0.72	175	
	—	383	412	634	547	616	14	42	6	6	157.5	0.37	1.6	0.88	343	
	—	361	364	446	426	446	13	13	3	2.5	89.2	0.41	1.5	0.80	33.6	
HR 32968 J 32068	4FD	361	362	446	427	446	13	19	3	2.5	91.0	0.44	1.4	0.75	34.3	
	—	373	386	498	464	496	3.5	22	5	4	104.5	0.37	1.6	0.89	83.7	
	—	381	386	466	445	465	14	14	3	2.5	91.4	0.40	1.5	0.82	35.8	
HR 32972 J 32072	4FD	381	381	466	445	466	13	19	3	2.5	96.8	0.46	1.3	0.72	36.1	
	—	393	402	518	480	514	5.5	22	5	4	108.6	0.38	1.6	0.86	86.5	
	—	407	406	502	478	501	16	16	4	3	95.2	0.39	1.6	0.86	49.5	
32976 32980 32080	—	427	428	522	499	524	16	16	4	3	100.8	0.40	1.5	0.82	52.7	
	—	433	443	578	533	565	5	25	5	4	115.3	0.36	1.7	0.92	116	
	—	447	448	542	521	544	3.5	15	4	3	106.1	0.41	1.5	0.81	54.8	
32084 32088	—	453	463	598	552	586	6.5	25	5	4	120.0	0.37	1.6	0.88	121	
	—	473	487	622	582	616	5	26	5	5	126.3	0.36	1.7	0.92	136	

SINGLE-ROW TAPERED ROLLER BEARINGS (INCH DESIGN)

Bore Diameter 12.000 – 22.225 mm

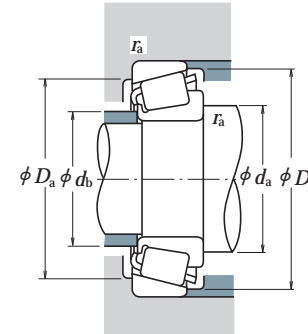
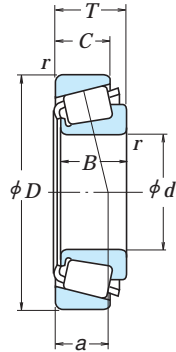

Dynamic Equivalent Load

$$P = XF_r + YF_a$$

$F_a / F_r \leq e$		$F_a / F_r > e$	
X	Y	X	Y
1	0	0.4	Y_1

Static Equivalent Load

$$P_0 = 0.5F_r + Y_0F_a$$

When $F_r > 0.5F_r + Y_0F_a$, use $P_0 = F_r$

The values of e , Y_1 , and Y_0 are given in the table below.

Boundary Dimensions (mm)					Basic Load Ratings (N)				Limiting Speeds (min ⁻¹)	
<i>d</i>	<i>D</i>	<i>T</i>	<i>B</i>	<i>C</i>	<i>C_r</i>	<i>C_{0r}</i>	<i>C_r</i>	<i>C_{0r}</i>	Grease	Oil
12.000	31.991	10.008	10.785	7.938	10 300	8 900	1 050	905	13 000	18 000
12.700	34.988	10.998	10.988	8.730	11 700	10 900	1 200	1 110	12 000	16 000
15.000	34.988	10.998	10.988	8.730	11 700	10 900	1 200	1 110	12 000	16 000
15.875	34.988	10.998	10.998	8.712	13 800	13 400	1 410	1 360	11 000	15 000
	39.992	12.014	11.153	9.525	14 900	15 700	1 520	1 600	9 500	13 000
	41.275	14.288	14.681	11.112	21 300	19 900	2 170	2 030	10 000	13 000
	42.862	14.288	14.288	9.525	17 300	17 200	1 770	1 750	8 500	12 000
	42.862	16.670	16.670	13.495	26 900	26 300	2 750	2 680	9 500	13 000
	44.450	15.494	14.381	11.430	23 800	23 900	2 430	2 440	8 500	11 000
	49.225	19.845	21.539	14.288	37 500	37 000	3 800	3 800	8 500	11 000
16.000	47.000	21.000	21.000	16.000	35 000	36 500	3 600	3 750	9 000	12 000
16.993	39.992	12.014	11.153	9.525	14 900	15 700	1 520	1 600	9 500	13 000
17.455	36.525	11.112	11.112	7.938	11 600	11 000	1 190	1 120	10 000	14 000
17.462	39.878	13.843	14.605	10.668	22 500	22 500	2 290	2 290	10 000	13 000
	47.000	14.381	14.381	11.112	23 800	23 900	2 430	2 440	8 500	11 000
19.050	39.992	12.014	11.153	9.525	14 900	15 700	1 520	1 600	9 500	13 000
	45.237	15.494	16.637	12.065	28 500	28 900	2 910	2 950	9 000	12 000
	47.000	14.381	14.381	11.112	23 800	23 900	2 430	2 440	8 500	11 000
	49.225	18.034	19.050	14.288	37 500	37 000	3 800	3 800	8 500	11 000
	49.225	19.845	21.539	14.288	37 500	37 000	3 800	3 800	8 500	11 000
	49.225	21.209	19.050	17.462	37 500	37 000	3 800	3 800	8 500	11 000
	49.225	23.020	21.539	17.462	37 500	37 000	3 800	3 800	8 500	11 000
	53.975	22.225	21.839	15.875	40 500	39 500	4 150	4 000	7 500	10 000
19.990	47.000	14.381	14.381	11.112	23 800	23 900	2 430	2 440	8 500	11 000
20.000	51.994	15.011	14.260	12.700	26 000	27 900	2 650	2 840	7 500	10 000
20.625	49.225	23.020	21.539	17.462	37 500	37 000	3 800	3 800	8 500	11 000
20.638	49.225	19.845	19.845	15.875	36 000	37 000	3 650	3 750	8 000	11 000
21.430	50.005	17.526	18.288	13.970	38 500	40 000	3 950	4 100	8 000	11 000
22.000	45.237	15.494	16.637	12.065	29 200	33 500	2 980	3 400	8 500	11 000
	45.975	15.494	16.637	12.065	29 200	33 500	2 980	3 400	8 500	11 000
22.225	50.005	13.495	14.260	9.525	26 000	27 900	2 650	2 840	7 500	10 000
	50.005	17.526	18.288	13.970	38 500	40 000	3 950	4 100	8 000	11 000
	52.388	19.368	20.168	14.288	40 500	43 000	4 100	4 400	7 500	10 000
	53.975	19.368	20.168	14.288	40 500	43 000	4 100	4 400	7 500	10 000
	56.896	19.368	19.837	15.875	38 000	40 500	3 900	4 150	7 100	9 500
	57.150	22.225	22.225	17.462	48 000	50 000	4 850	5 100	7 100	9 500

Bearing Numbers		Abutment and Fillet Dimensions (mm)				Eff. Load Centers (mm)	Constant	Axial Load Factors		Mass (kg)	
CONE	CUP	<i>d_a</i>	<i>d_b</i>	<i>D_a</i>	<i>D_b</i>	<i>a</i>	<i>e</i>	<i>Y₁</i>	<i>Y₀</i>	approx. CONE	CUP
*A 2047	A 2126	16.5	15.5	26	29	0.8	1.3	6.8	0.41	1.5	0.81
A 4050	A 4138	18.5	17	29	32	1.3	1.3	8.2	0.45	1.3	0.73
*A 4059	A 4138	19.5	19	29	32	0.8	1.3	8.2	0.45	1.3	0.73
L 21549	L 21511	21.5	19.5	29	32.5	1.3	1.3	7.7	0.32	1.9	1.0
A 6062	A 6157	22	20.5	34	37	1.3	1.3	10.3	0.53	1.1	0.63
03062	03162	21.5	20	34	37.5	1.3	2	9.1	0.31	1.9	1.1
11590	11520	24.5	22.5	34.5	39.5	1.5	1.5	13.0	0.70	0.85	0.47
17580	17520	23	21	36.5	39	1.5	1.5	10.6	0.33	1.8	1.0
05062	05175	23.5	21	38	42	1.5	1.5	11.2	0.36	1.7	0.93
09062	09195	22	21.5	42	44.5	0.8	1.3	10.7	0.27	2.3	1.2
*HM 81649	**HM 81610	27.5	23	37.5	43	1	2	14.9	0.55	1.1	0.60
A 6067	A 6157	22	21	34	37	0.8	1.3	10.3	0.53	1.1	0.63
A 5069	A 5144	23.5	21.5	30	33.5	1.5	1.5	8.9	0.49	1.2	0.68
† LM 11749	† LM 11710	23	21.5	34	37	1.3	1.3	8.7	0.29	2.1	1.2
05068	05185	23	22.5	40.5	42.5	0.8	1.3	10.1	0.36	1.7	0.93
A 6075	A 6157	24	23	34	37	1	1.3	10.3	0.53	1.1	0.63
† LM 11949	† LM 11910	25	23.5	39.5	41.5	1.3	1.3	9.5	0.30	2.0	1.1
05075	05185	25	23.5	40.5	42.5	1.3	1.3	10.1	0.36	1.7	0.93
09067	09195	25.5	24	42	44.5	1.3	1.3	10.7	0.27	2.3	1.2
09078	09195	25.5	24	42	44.5	1.2	1.3	10.7	0.27	2.3	1.2
09067	09196	25.5	24	41.5	44.5	1.3	1.5	13.8	0.27	2.3	1.2
09074	09194	26	24	39	44.5	1.5	3.5	13.8	0.27	2.3	1.2
21075	21212	31.5	26	43	50	1.5	2.3	16.3	0.59	1.0	0.56
05079	05185	26.5	24	40.5	42.5	1.5	1.3	10.1	0.36	1.7	0.93
07079	07204	27.5	27	45	48	1.5	1.3	12.1	0.40	1.5	0.82
09081	09196	27.5	25.5	41.5	44.5	1.5	1.5	13.8	0.27	2.3	1.2
12580	12520	28.5	26	42.5	45.5	1.5	1.5	12.9	0.32	1.9	1.0
† M 12649	† M 12610	27.5	25.5	44	46	1.3	1.3	10.9	0.28	2.2	1.2
*† LM 12749	† LM 12710	27.5	26	39.5	42.5	1.3	1.3	10.0	0.31	2.0	1.1
*† LM 12749	† LM 12711	27.5	26	40	42.5	1.3	1.3	10.0	0.31	2.0	1.1
07087	07196	28.5	27	44.5	47	1.3	1	10.6	0.40	1.5	0.82
† M 12648	† M 12610	28.5	26.5	44	46	1.3	1.3	10.9	0.28	2.2	1.2
1380	1328	29.5	27	45	48.5	1.5	1.5	11.3	0.29	2.1	1.1
1380	1329	29.5	27	46	49	1.5	1.5	11.3	0.29	2.1	1.1
1755	1729	29	27.5	49	51	1.3	1.3	12.2	0.31	2.0	1.1
1280	1220	29.5	29	49	52	0.8	1.5	15.1	0.35	1.7	0.95

- Notes
- * The maximum bore diameter is listed and its tolerance is negative (See Table 8.4.1 on Page A68).
 - ** The maximum outside diameter is listed and its tolerance is negative (See Table 8.4.2 on Pages A68 and A69).
 - † The tolerances for the bore diameter and overall bearing width differ from the standard (See Table 5 on Page B114).
 - * † The tolerance for the bore diameter is 0 to -20 μm, and for overall bearing width is +356 to 0 μm.

Bore Diameter 22.606 – 28.575 mm

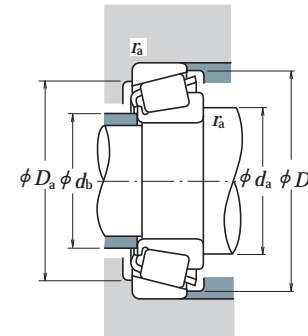
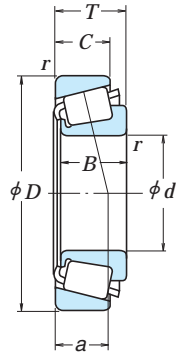

Dynamic Equivalent Load

$$P = XF_r + YF_a$$

$F_a / F_r \leq e$		$F_a / F_r > e$	
X	Y	X	Y
1	0	0.4	Y_1

Static Equivalent Load

$$P_0 = 0.5F_r + Y_0F_a$$

When $F_r > 0.5F_r + Y_0F_a$, use $P_0 = F_r$

The values of e , Y_1 , and Y_0 are given in the table below.

Boundary Dimensions (mm)					Basic Load Ratings (N)				Limiting Speeds (min ⁻¹)	
d	D	T	B	C	C_r	C_{0r}	C_r	C_{0r}	Grease	Oil
22.606	47.000	15.500	15.500	12.000	26 300	30 000	2 680	3 100	8 000	11 000
23.812	50.292	14.224	14.732	10.668	27 600	32 000	2 820	3 250	7 100	10 000
	56.896	19.368	19.837	15.875	38 000	40 500	3 900	4 150	7 100	9 500
24.000	55.000	25.000	25.000	21.000	49 500	55 000	5 050	5 650	7 100	9 500
24.981	51.994	15.011	14.260	12.700	26 000	27 900	2 650	2 840	7 500	10 000
	52.001	15.011	14.260	12.700	26 000	27 900	2 650	2 840	7 500	10 000
	62.000	16.002	16.566	14.288	37 000	39 500	3 750	4 000	6 300	8 500
25.000	50.005	13.495	14.260	9.525	26 000	27 900	2 650	2 840	7 500	10 000
	51.994	15.011	14.260	12.700	26 000	27 900	2 650	2 840	7 500	10 000
25.400	50.005	13.495	14.260	9.525	26 000	27 900	2 650	2 840	7 500	10 000
	50.005	13.495	14.260	9.525	26 000	27 900	2 650	2 840	7 500	10 000
	50.292	14.224	14.732	10.668	27 600	32 000	2 820	3 250	7 100	10 000
	57.150	17.462	17.462	13.495	39 500	45 500	4 050	4 650	6 700	9 000
	57.150	19.431	19.431	14.732	42 500	49 000	4 300	5 000	6 700	9 000
	59.530	23.368	23.114	18.288	50 000	58 000	5 100	5 900	6 300	9 000
	62.000	19.050	20.638	14.288	46 000	53 000	4 700	5 400	6 000	8 000
	63.500	20.638	20.638	15.875	46 000	53 000	4 700	5 400	6 000	8 000
	64.292	21.433	21.433	16.670	51 000	64 500	5 200	6 600	5 600	8 000
	65.088	22.225	21.463	15.875	45 000	47 500	4 600	4 850	5 600	8 000
	68.262	22.225	22.225	17.462	55 000	64 000	5 600	6 550	5 600	7 500
	72.233	25.400	25.400	19.842	63 500	83 500	6 500	8 500	5 000	7 100
	72.626	24.608	24.257	17.462	60 000	58 000	6 100	5 900	5 600	7 500
26.988	50.292	14.224	14.732	10.668	27 600	32 000	2 820	3 250	7 100	10 000
	57.150	19.845	19.355	15.875	40 000	44 500	4 100	4 500	6 700	9 000
	60.325	19.842	17.462	15.875	39 500	45 500	4 050	4 650	6 700	9 000
	62.000	19.050	20.638	14.288	46 000	53 000	4 700	5 400	6 000	8 000
28.575	57.150	19.845	19.355	15.875	40 000	44 500	4 100	4 500	6 700	9 000
	59.131	15.875	16.764	11.811	34 500	41 500	3 550	4 200	6 300	8 500
	62.000	19.050	20.638	14.288	46 000	53 000	4 700	5 400	6 000	8 000
	62.000	19.050	20.638	14.288	46 000	53 000	4 700	5 400	6 000	8 000
	64.292	21.433	21.433	16.670	51 000	64 500	5 200	6 600	5 600	8 000
	68.262	22.225	22.225	17.462	55 000	64 000	5 600	6 550	5 600	7 500
	72.626	24.608	24.257	17.462	60 000	58 000	6 100	5 900	5 600	7 500
	72.626	24.608	24.257	17.462	60 000	58 000	6 100	5 900	5 600	7 500
	73.025	22.225	22.225	17.462	54 500	64 500	5 550	6 600	5 300	7 100

Bearing Numbers		Abutment and Fillet Dimensions (mm)				Eff. Load Centers (mm)	Constant	Axial Load Factors		Mass (kg)			
CONE	CUP	d_a	d_b	D_a	D_b	a	e	Y_1	Y_0	approx. CONE	CUP		
LM 72849	LM 72810	29	27	40.5	44.5	1.5	1	12.2	0.47	1.3	0.70	0.086	0.046
† L 44640	† L 44610	30.5	28.5	44.5	47	1.5	1.3	10.9	0.37	1.6	0.88	0.097	0.039
1779	1729	29.5	28.5	49	51	0.8	1.3	12.2	0.31	2.0	1.1	0.143	0.102
▲ JHM 33449	▲ JHM 33410	35	30	47	52	2	2	15.8	0.35	1.7	0.93	0.181	0.107
07098	07204	31	29	45	48	1.5	1.3	12.1	0.40	1.5	0.82	0.085	0.061
07098	07205	31	29	44.5	48	1.5	2	12.1	0.40	1.5	0.82	0.085	0.061
17098	17244	33	30.5	54	57	1.5	1.5	12.8	0.38	1.6	0.86	0.165	0.091
07097	07196	31	29	44.5	47	1.5	1	10.6	0.40	1.5	0.82	0.085	0.035
07097	07204	31	29	45	48	1.5	1.3	12.1	0.40	1.5	0.82	0.085	0.061
07100 SA	07196	35	29.5	44.5	47	3.3	1	10.6	0.40	1.5	0.82	0.082	0.035
07100	07196	30.5	29.5	44.5	47	1	1	10.6	0.40	1.5	0.82	0.084	0.035
† L 44643	† L 44610	31.5	29.5	44.5	47	1.3	1.3	10.9	0.37	1.6	0.88	0.090	0.039
15578	15520	32.5	30.5	51	53	1.3	1.5	12.4	0.35	1.7	0.95	0.151	0.070
M 84548	M 84510	36	33	48.5	54	1.5	1.5	16.1	0.55	1.1	0.60	0.156	0.089
M 84249	M 84210	36	32.5	49.5	56	0.8	1.5	18.3	0.55	1.1	0.60	0.194	0.13
15101	15245	32.5	31.5	55	58	0.8	1.3	13.3	0.35	1.7	0.94	0.222	0.081
15100	15250 X	38	31.5	55	59	3.5	1.5	14.9	0.35	1.7	0.94	0.22	0.113
M 86643	M 86610	38	36.5	54	61	1.5	1.5	17.7	0.55	1.1	0.60	0.246	0.128
23100	23256	39	34.5	53	61	1.5	1.5	20.0	0.73	0.82	0.45	0.214	0.142
02473	02420	34.5	33.5	59	63	0.8	1.5	16.9	0.42	1.4	0.79	0.28	0.152
HM 88630	HM 88610	39.5	39.5	60	69	0.8	2.3	20.7	0.55	1.1	0.60	0.398	0.188
41100	41286	41	36.5	61	68	2.3	1.5	20.7	0.60	1.0	0.55	0.32	0.177
† L 44649	† L 44610	37.5	31	44.5	47	3.5	1.3	10.9	0.37	1.6	0.88	0.081	0.039
1997 X	1922	37.5	31.5	51	53.5	3.3	1.5	13.9	0.33	1.8	1.0	0.152	0.077
15580	15523	38.5	32	51	54	3.5	1.5	14.7	0.35	1.7	0.95	0.141	0.123
15106	15245	33.5	33	55	58	0.8	1.3	13.3	0.35	1.7	0.94	0.211	0.081
1988	1922	39.5	33.5	51	53.5	3.5	1.5	13.9	0.33	1.8	1.0	0.141	0.077
† LM 67043	† LM 67010	40	33.5	52	56	3.5	1.3	12.6	0.41	1.5	0.80	0.147	0.062
15112	15245	40	34	55	58	3.5	1.3	13.3	0.35	1.7	0.94	0.199	0.081
15113	15245	34.5	34	55	58	0.8	1.3	13.3	0.35	1.7	0.94	0.20	0.081
M 86647	M 86610	40	38	54	61	1.5	1.5	17.7	0.55	1.1	0.60	0.223	0.128
02474	02420	36.5	36	59	63	0.8	1.5	16.9	0.42	1.4	0.79	0.257	0.152
41125	41286	48	36.5	61	68	4.8	1.5	20.7	0.60	1.0	0.55	0.292	0.177
41126	41286	41.5	36.5	61	68	1.5	1.5	20.7	0.60	1.0	0.55	0.295	0.177
02872	02820	37.5	37	62	68	0.8	3.3	18.3	0.45	1.3	0.73	0.321	0.16

Notes † The tolerances for the bore diameter and overall bearing width differ from the standard (See Table 5 on Page B114).
▲ The tolerances are listed in Tables 2, 3 and 4 on Pages B113 and B114.

SINGLE-ROW TAPERED ROLLER BEARINGS (INCH DESIGN)

Bore Diameter 29.000 – 32.000 mm

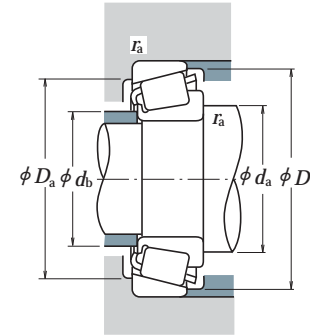
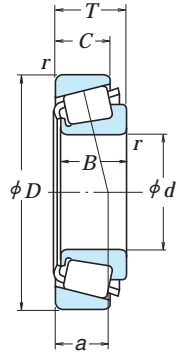

Dynamic Equivalent Load

$$P = XF_r + YF_a$$

$F_a / F_r \leq e$		$F_a / F_r > e$	
X	Y	X	Y
1	0	0.4	Y_1

Static Equivalent Load

$P_0 = 0.5F_r + Y_0F_a$
 When $F_r > 0.5F_r + Y_0F_a$, use $P_0 = F_r$
 The values of e , Y_1 , and Y_0 are given in the table below.

Boundary Dimensions (mm)					Basic Load Ratings (N)				Limiting Speeds (min ⁻¹)			
<i>d</i>	<i>D</i>	<i>T</i>	<i>B</i>	<i>C</i>	Cone <i>r</i> min.	Cup <i>r</i> min.	<i>C_r</i>	<i>C_{0r}</i>	<i>C_r</i>	<i>C_{0r}</i>	Grease	Oil
29.000	50.292	14.224	14.732	10.668	3.5	1.3	26 800	34 000	2 730	3 500	7 100	9 500
29.367	66.421	23.812	25.433	19.050	3.5	1.3	65 000	73 000	6 600	7 450	6 000	8 000
30.000	62.000	16.002	16.566	14.288	1.5	1.5	37 000	39 500	3 750	4 000	6 300	8 500
	62.000	19.050	20.638	14.288	1.3	1.3	46 000	53 000	4 700	5 400	6 000	8 000
	63.500	20.638	20.638	15.875	1.3	1.3	46 000	53 000	4 700	5 400	6 000	8 000
	72.000	19.000	18.923	15.875	1.5	1.5	52 000	56 000	5 300	5 700	5 600	7 500
30.112	62.000	19.050	20.638	14.288	0.8	1.3	46 000	53 000	4 700	5 400	6 000	8 000
30.162	58.738	14.684	15.080	10.716	3.5	1.0	28 800	33 500	2 940	3 450	6 000	8 000
	64.292	21.433	21.433	16.670	1.5	1.5	51 000	64 500	5 200	6 600	5 600	8 000
	68.262	22.225	22.225	17.462	2.3	1.5	55 500	70 500	5 650	7 200	5 300	7 500
	69.850	23.812	25.357	19.050	2.3	1.3	71 000	84 000	7 200	8 550	5 600	7 500
	69.850	23.812	25.357	19.050	0.8	1.3	71 000	84 000	7 200	8 550	5 600	7 500
	76.200	24.608	24.074	16.670	1.5	C3.3	67 500	69 500	6 850	7 100	5 000	6 700
30.213	62.000	19.050	20.638	14.288	3.5	1.3	46 000	53 000	4 700	5 400	6 000	8 000
	62.000	19.050	20.638	14.288	0.8	1.3	46 000	53 000	4 700	5 400	6 000	8 000
	62.000	19.050	20.638	14.288	1.5	1.3	46 000	53 000	4 700	5 400	6 000	8 000
30.955	64.292	21.433	21.433	16.670	1.5	1.5	51 000	64 500	5 200	6 600	5 600	8 000
31.750	58.738	14.684	15.080	10.716	1.0	1.0	28 800	33 500	2 940	3 450	6 000	8 000
	59.131	15.875	16.764	11.811	spec.	1.3	34 500	41 500	3 550	4 200	6 300	8 500
	62.000	18.161	19.050	14.288	spec.	1.3	46 000	53 000	4 700	5 400	6 000	8 000
	62.000	19.050	20.638	14.288	0.8	1.3	46 000	53 000	4 700	5 400	6 000	8 000
	62.000	19.050	20.638	14.288	3.5	1.3	46 000	53 000	4 700	5 400	6 000	8 000
	63.500	20.638	20.638	15.875	0.8	1.3	46 000	53 000	4 700	5 400	6 000	8 000
	68.262	22.225	22.225	17.462	3.5	1.5	55 000	64 000	5 600	6 550	5 600	7 500
	68.262	22.225	22.225	17.462	1.5	1.5	55 500	70 500	5 650	7 200	5 300	7 500
	69.012	19.845	19.583	15.875	3.5	1.3	47 000	56 000	4 800	5 700	5 600	7 500
	69.012	26.982	26.721	15.875	4.3	3.3	47 000	56 000	4 800	5 700	5 600	7 500
	69.850	23.812	25.357	19.050	0.8	1.3	71 000	84 000	7 200	8 550	5 600	7 500
	69.850	23.812	25.357	19.050	3.5	1.3	71 000	84 000	7 200	8 550	5 600	7 500
	72.626	30.162	29.997	23.812	0.8	3.3	79 500	90 000	8 100	9 200	5 300	7 500
	73.025	29.370	27.783	23.020	1.3	3.3	74 000	100 000	7 550	10 200	5 000	7 100
	80.000	21.000	22.403	17.826	0.8	1.3	68 500	75 500	6 950	7 700	4 500	6 300
32.000	72.233	25.400	25.400	19.842	3.3	2.3	63 500	83 500	6 500	8 500	5 000	7 100

Bearing Numbers		Abutment and Fillet Dimensions (mm)				Eff. Load Centers (mm)		Constant	Axial Load Factors		Mass (kg)		
CONE	CUP	<i>d_a</i>	<i>d_b</i>	<i>D_a</i>	<i>D_b</i>	Cone <i>r_a</i> max.	Cup <i>r_a</i> max.	<i>e</i>	<i>Y₁</i>	<i>Y₀</i>	approx. CONE	CUP	
† L 45449	† L 45410	39.5	33	44.5	48	3.5	1.3	10.8	0.37	1.6	0.89	0.079	0.036
2690	2631	41	35	58	60	3.5	1.3	14.3	0.25	2.4	1.3	0.242	0.165
* 17118	17244	37	34.5	54	57	1.5	1.5	12.8	0.38	1.6	0.86	0.136	0.091
* 15117	15245	36.5	35	55	58	1.3	1.3	13.3	0.35	1.7	0.94	0.189	0.081
* 15117	15250	36.5	35	56	59	1.3	1.3	14.9	0.35	1.7	0.94	0.189	0.113
* 26118	26283	38	36	62	65	1.5	1.5	14.8	0.36	1.7	0.92	0.225	0.163
15116	15245	36	35.5	55	58	0.8	1.3	13.3	0.35	1.7	0.94	0.189	0.081
08118	08231	41.5	35	52	55	3.5	1	13.3	0.47	1.3	0.70	0.12	0.057
M 86649	M 86610	41	38	54	61	1.5	1.5	17.7	0.55	1.1	0.60	0.211	0.128
M 88043	M 88010	43.5	39.5	58	65	2.3	1.5	19.1	0.55	1.1	0.60	0.263	0.146
2558	2523	40	36.5	61	64	2.3	1.3	14.5	0.27	2.2	1.2	0.297	0.169
2559	2523	37	36.5	61	64	0.8	1.3	14.5	0.27	2.2	1.2	0.298	0.169
43118	43300	45	42	64	73	1.5	3.3	22.9	0.67	0.90	0.49	0.383	0.146
15118	15245	41.5	35.5	55	58	3.5	1.3	13.3	0.35	1.7	0.94	0.186	0.081
15120	15245	36	35.5	55	58	0.8	1.3	13.3	0.35	1.7	0.94	0.188	0.081
15119	15245	37.5	35.5	55	58	1.5	1.3	13.3	0.35	1.7	0.94	0.188	0.081
M 86648 A	M 86610	42	38	54	61	1.5	1.5	17.7	0.55	1.1	0.60	0.205	0.128
08125	08231	37.5	36	52	55	1	1	13.3	0.47	1.3	0.70	0.113	0.057
† LM 67048	† LM 67010	42.5	36	52	56	3.5	1.3	12.6	0.41	1.5	0.80	0.127	0.062
15123	15245	42.5	36.5	55	58	3.5	1.3	13.3	0.35	1.7	0.94	0.165	0.081
15126	15245	37	36.5	55	58	0.8	1.3	13.3	0.35	1.7	0.94	0.176	0.081
15125	15245	42.5	36.5	55	58	3.5	1.3	13.3	0.35	1.7	0.94	0.174	0.081
15126	15250	37	36.5	56	59	0.8	1.3	14.9	0.35	1.7	0.94	0.176	0.113
02475	02420	44.5	38.5	59	63	3.5	1.5	16.9	0.42	1.4	0.79	0.229	0.152
M 88046	M 88010	43	40.5	58	65	1.5	1.5	19.1	0.55	1.1	0.60	0.25	0.146
14125 A	14276	44	37.5	60	63	3.5	1.3	15.3	0.38	1.6	0.86	0.219	0.135
14123 A	14274	41.5	37.5	59	63	4.3	3.3	15.1	0.38	1.6	0.87	0.289	0.132
2580	2523	38.5	37.5	61	64	0.8	1.3	14.5	0.27	2.2	1.2	0.282	0.169
2582	2523	44	37.5	61	64	3.5	1.3	14.5	0.27	2.2	1.2	0.28	0.169
3188	3120	39.5	39.5	61	67	0.8	3.3	19.6	0.33	1.8	0.99	0.368	0.225
HM 88542	HM 88510	45.5	42.5	59	70	1.3	3.3	23.5	0.55	1.1	0.60	0.379	0.242
346	332	40	39.5	73	75	0.8	1.3	14.6	0.27	2.2	1.2	0.419	0.146
*HM 88638	HM 88610	48.5	42.5	60	69	3.3	2.3	20.7	0.55	1.1	0.60	0.337	0.188

Notes * The maximum bore diameter is listed and its tolerance is negative (See Table 8.4.1 on Page A68).
 † The tolerances for the bore diameter and overall bearing width differ from the standard (See Table 5 on Page B114).

Bore Diameter 33.338 – 35.000 mm

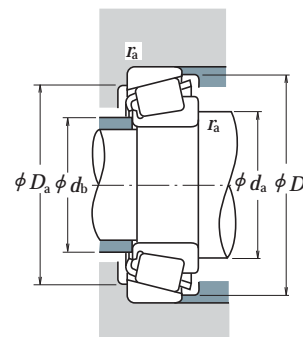
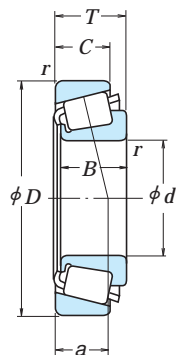

Dynamic Equivalent Load

$$P = XF_r + YF_a$$

$F_a/F_r \leq e$		$F_a/F_r > e$	
X	Y	X	Y
1	0	0.4	Y_1

Static Equivalent Load

$$P_0 = 0.5F_r + Y_0F_a$$

When $F_r > 0.5F_r + Y_0F_a$, use $P_0 = F_r$

The values of e , Y_1 , and Y_0 are given in the table below.

d	Boundary Dimensions (mm)				Cone r min.	Cup r	Basic Load Ratings (N)				Limiting Speeds (min ⁻¹)	
	D	T	B	C			C _r	C _{0r}	C _r	C _{0r}	Grease	Oil
33.338	66.675	20.638	20.638	15.875	3.5	1.5	46 000	53 500	4 650	5 450	5 600	7 500
	68.262	22.225	22.225	17.462	0.8	1.5	55 500	70 500	5 650	7 200	5 300	7 500
	69.012	19.845	19.583	15.875	3.5	3.3	47 000	56 000	4 800	5 700	5 600	7 500
	69.012	19.845	19.583	15.875	0.8	1.3	47 000	56 000	4 800	5 700	5 600	7 500
	69.850	23.812	25.357	19.050	3.5	1.3	71 000	84 000	7 200	8 550	5 600	7 500
	72.000	19.000	18.923	15.875	3.5	1.5	52 000	56 000	5 300	5 700	5 600	7 500
	72.626	30.162	29.997	23.812	0.8	3.3	79 500	90 000	8 100	9 200	5 300	7 500
	73.025	29.370	27.783	23.020	0.8	3.3	74 000	100 000	7 550	10 200	5 000	7 100
	76.200	29.370	28.575	23.020	3.8	0.8	78 500	106 000	8 000	10 800	4 800	6 700
	76.200	29.370	28.575	23.020	0.8	3.3	78 500	106 000	8 000	10 800	4 800	6 700
79.375	25.400	24.074	17.462	3.5	1.5	67 500	69 500	6 850	7 100	5 000	6 700	
34.925	65.088	18.034	18.288	13.970	spec.	1.3	47 500	57 500	4 850	5 900	5 600	7 500
	65.088	20.320	18.288	16.256	spec.	1.3	47 500	57 500	4 850	5 900	5 600	7 500
	66.675	20.638	20.638	16.670	3.5	2.3	53 000	62 500	5 400	6 400	5 600	7 500
	69.012	19.845	19.583	15.875	3.5	1.3	47 000	56 000	4 800	5 700	5 600	7 500
	69.012	19.845	19.583	15.875	1.5	1.3	47 000	56 000	4 800	5 700	5 600	7 500
	72.233	25.400	25.400	19.842	2.3	2.3	63 500	83 500	6 500	8 500	5 000	7 100
	73.025	22.225	22.225	17.462	0.8	3.3	54 500	64 500	5 550	6 600	5 300	7 100
	73.025	22.225	23.812	17.462	3.5	3.3	63 500	77 000	6 500	7 850	5 300	7 100
	73.025	23.812	24.608	19.050	1.5	0.8	71 000	86 000	7 250	8 750	5 300	7 100
	73.025	23.812	24.608	19.050	3.5	2.3	71 000	86 000	7 250	8 750	5 300	7 100
76.200	29.370	28.575	23.020	0.8	0.8	78 500	106 000	8 000	10 800	4 800	6 700	
76.200	29.370	28.575	23.020	3.5	0.8	78 500	106 000	8 000	10 800	4 800	6 700	
76.200	29.370	28.575	23.020	0.8	0.8	78 500	106 000	8 000	10 800	4 800	6 700	
76.200	29.370	28.575	23.020	3.5	3.3	78 500	106 000	8 000	10 800	4 800	6 700	
76.200	29.370	28.575	23.812	1.5	3.3	80 500	96 500	8 200	9 850	5 000	6 700	
79.375	29.370	29.771	23.812	3.5	3.3	88 000	106 000	8 950	10 800	4 800	6 700	
34.976	68.262	15.875	16.520	11.908	1.5	1.5	45 000	53 500	4 600	5 450	5 300	7 100
	72.085	22.385	19.583	18.415	1.3	2.3	47 000	56 000	4 800	5 700	5 600	7 500
	80.000	21.006	20.940	15.875	1.5	1.5	56 500	64 500	5 750	6 600	5 000	6 700
35.000	59.131	15.875	16.764	11.938	spec.	1.3	35 000	47 000	3 550	4 750	6 000	8 000
	59.975	15.875	16.764	11.938	spec.	1.3	35 000	47 000	3 550	4 750	6 000	8 000
	62.000	16.700	17.000	13.600	spec.	1.0	38 000	50 000	3 900	5 100	5 600	8 000
	62.000	16.700	17.000	13.600	spec.	1.5	38 000	50 000	3 900	5 100	5 600	8 000
	65.987	20.638	20.638	16.670	3.5	2.3	53 000	62 500	5 400	6 400	5 600	7 500
	73.025	26.988	26.975	22.225	3.5	0.8	75 500	88 500	7 650	9 050	5 300	7 500

Bearing Numbers		Abutment and Fillet Dimensions (mm)				Cone r _a max.	Cup r _b max.	Eff. Load Centers (mm) a	Constant e	Axial Load Factors		Mass (kg)	
CONE	CUP	d _a	d _b	D _a	D _b					Y ₁	Y ₀		approx. CONE
1680	1620	44.5	38.5	58	61	3.5	1.5	15.2	0.37	1.6	0.89	0.196	0.121
M 88048	M 88010	42.5	41	58	65	0.8	1.5	19.0	0.55	1.1	0.60	0.236	0.146
14130	14274	45	38.5	59	63	3.5	3.3	15.3	0.38	1.6	0.86	0.207	0.132
14131	14276	39.5	38.5	60	63	0.8	1.3	15.3	0.38	1.6	0.86	0.209	0.135
2585	2523	45	39	61	64	3.5	1.3	14.5	0.27	2.2	1.2	0.263	0.169
26131	26283	44.5	38.5	62	65	3.5	1.5	14.7	0.36	1.7	0.92	0.20	0.163
3197	3120	41.5	40.5	61	67	0.8	3.3	19.6	0.33	1.8	0.99	0.348	0.225
HM 88547	HM 88510	45.5	42.5	59	70	0.8	3.3	23.5	0.55	1.1	0.60	0.362	0.242
HM 89444	HM 89411	53	44.5	65	73	3.8	0.8	23.6	0.55	1.1	0.60	0.419	0.261
HM 89443	HM 89410	46.5	44.5	62	73	0.8	3.3	23.6	0.55	1.1	0.60	0.421	0.257
43131	43312	51	42	67	74	3.5	1.5	23.7	0.67	0.90	0.49	0.348	0.22
† LM 48548	† LM 48510	46	40	58	61	3.5	1.3	14.1	0.38	1.6	0.88	0.172	0.087
† LM 48548	† LM 48511	46	40	58	61	3.5	1.3	16.4	0.38	1.6	0.88	0.172	0.108
M 38549	M 38510	46.5	40	58	62	3.5	2.3	15.2	0.35	1.7	0.94	0.194	0.112
14138 A	14276	46	40	60	63	3.5	1.3	15.3	0.38	1.6	0.86	0.194	0.135
14137 A	14276	42	40	60	63	1.5	1.3	15.1	0.38	1.6	0.86	0.196	0.135
HM 88649	HM 88610	48.5	42.5	60	69	2.3	2.3	20.7	0.55	1.1	0.60	0.307	0.188
02878	02820	42.5	42	62	68	0.8	3.3	18.3	0.45	1.3	0.73	0.266	0.16
2877	2820	47	41.5	63	68	3.5	3.3	16.1	0.37	1.6	0.90	0.291	0.15
25877	25821	43	40.5	65	68	1.5	0.8	15.7	0.29	2.1	1.1	0.306	0.167
25878	25820	47	40.5	64	68	3.5	2.3	15.7	0.29	2.1	1.1	0.304	0.165
HM 89446 A	HM 89411	47.5	44.5	65	73	0.8	0.8	23.6	0.55	1.1	0.60	0.403	0.261
HM 89446	HM 89411	53	44.5	65	73	3.5	0.8	23.6	0.55	1.1	0.60	0.40	0.261
HM 89446	HM 89410	53	44.5	62	73	3.5	3.3	23.6	0.55	1.1	0.60	0.40	0.257
31594	31520	46	43.5	64	72	1.5	3.3	21.6	0.40	1.5	0.82	0.404	0.235
3478	3420	50	43.5	67	74	3.5	3.3	20.0	0.37	1.6	0.90	0.448	0.259
19138	19268	42.5	40.5	61	65	1.5	1.5	14.5	0.44	1.4	0.74	0.196	0.073
14139	14283	41.5	40	60	65	1.3	2.3	17.7	0.38	1.6	0.87	0.198	0.21
28138	28315	43.5	41	69	73	1.5	1.5	16.0	0.40	1.5	0.82	0.308	0.199
*† L 68149	† L 68110	45.5	39	52	56	3.5	1.3	13.2	0.42	1.4	0.79	0.117	0.056
*† L 68149	† L 68111	45.5	39	53	56	3.5	1.3	13.2	0.42	1.4	0.79	0.117	0.064
* LM 78349	** LM 78310	46	40	55	59	3.5	1	14.4	0.44	1.4	0.74	0.137	0.074
* LM 78349	** LM 78310 A	46	40	54	59	3.5	1.5	14.4	0.44	1.4	0.74	0.138	0.073
M 38547	M 38511	46	39.5	59	61	3.5	2.3	15.2	0.35	1.7	0.94	0.193	0.103
23691	23621	49	42	63	68	3.5	0.8	18.1	0.37	1.6	0.89	0.309	0.212

- Notes
- * The maximum bore diameter is listed and its tolerance is negative (See Table 8.4.1 on Page A68).
 - ** The maximum outside diameter is listed and its tolerance is negative (See Table 8.4.2 on Pages A68 and A69).
 - † The tolerances for the bore diameter and overall bearing width differ from the standard (See Table 5 on Page B114).
 - * † The tolerance for the bore diameter is 0 to -20 μm, and for overall bearing width is +35 to 0 μm.

SINGLE-ROW TAPERED ROLLER BEARINGS (INCH DESIGN)

Bore Diameter 35.717 – 41.275 mm

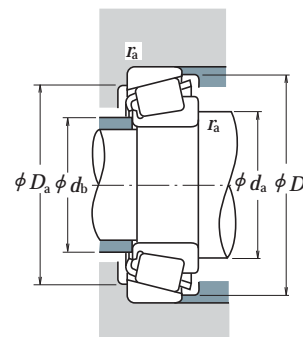
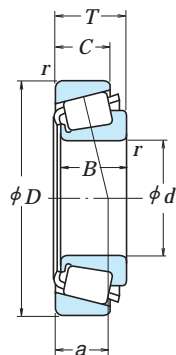

Dynamic Equivalent Load

$$P = XF_r + YF_a$$

$F_a / F_r \leq e$		$F_a / F_r > e$	
X	Y	X	Y
1	0	0.4	Y_1

Static Equivalent Load

$$P_0 = 0.5F_r + Y_0F_a$$

When $F_r > 0.5F_r + Y_0F_a$, use $P_0 = F_r$

The values of e , Y_1 , and Y_0 are given in the table below.

Boundary Dimensions (mm)					Cone		Basic Load Ratings (N)				Limiting Speeds (min ⁻¹)	
<i>d</i>	<i>D</i>	<i>T</i>	<i>B</i>	<i>C</i>	<i>r</i> _{min.}	Cup	<i>C_r</i>	<i>C_{0r}</i>	<i>C_r</i>	<i>C_{0r}</i>	Grease	Oil
35.717	72.233	25.400	25.400	19.842	3.5	2.3	63 500	83 500	6 500	8 500	5 000	7 100
36.487	73.025	23.812	24.608	19.050	1.5	0.8	71 000	86 000	7 250	8 750	5 300	7 100
36.512	76.200	29.370	28.575	23.020	3.5	3.3	78 500	106 000	8 000	10 800	4 800	6 700
	79.375	29.370	29.771	23.812	0.8	3.3	88 000	106 000	8 950	10 800	4 800	6 700
	88.501	25.400	23.698	17.462	2.3	1.5	73 000	81 000	7 450	8 250	4 000	5 600
	93.662	31.750	31.750	26.195	1.5	3.3	110 000	142 000	11 200	14 400	4 000	5 600
38.000	63.000	17.000	17.000	13.500	spec.	1.3	38 500	52 000	3 900	5 300	5 600	7 500
38.100	63.500	12.700	11.908	9.525	1.5	0.8	24 100	30 500	2 460	3 100	5 300	7 100
	65.088	18.034	18.288	13.970	2.3	1.3	42 500	55 000	4 300	5 650	5 300	7 500
	65.088	18.034	18.288	13.970	spec.	1.3	42 500	55 000	4 300	5 650	5 300	7 500
	65.088	19.812	18.288	15.748	2.3	1.3	42 500	55 000	4 300	5 650	5 300	7 500
	68.262	15.875	16.520	11.908	1.5	1.5	45 000	53 500	4 600	5 450	5 300	7 100
	69.012	19.050	19.050	15.083	2.0	2.3	49 000	61 000	4 950	6 250	5 300	7 100
	69.012	19.050	19.050	15.083	3.5	0.8	49 000	61 000	4 950	6 250	5 300	7 100
	72.238	20.638	20.638	15.875	3.5	1.3	48 500	59 500	4 950	6 050	5 300	7 100
	73.025	23.812	25.654	19.050	3.5	0.8	73 500	91 000	7 500	9 300	5 000	6 700
	76.200	23.812	25.654	19.050	3.5	0.8	73 500	91 000	7 500	9 300	5 000	6 700
	79.375	29.370	29.771	23.812	3.5	3.3	88 000	106 000	8 950	10 800	4 800	6 700
	80.035	24.608	23.698	18.512	0.8	1.5	69 000	84 500	7 000	8 600	4 500	6 300
	82.550	29.370	28.575	23.020	0.8	3.3	87 000	117 000	8 850	11 900	4 500	6 000
	88.501	25.400	23.698	17.462	2.3	1.5	73 000	81 000	7 450	8 250	4 000	5 600
	88.501	26.988	29.083	22.225	3.5	1.5	96 500	109 000	9 800	11 100	4 500	6 000
	95.250	30.958	28.301	20.638	1.5	0.8	87 500	97 000	8 950	9 850	3 600	5 300
39.688	73.025	25.654	22.098	21.336	0.8	2.3	62 500	80 000	6 400	8 150	5 000	6 700
	76.200	23.812	25.654	19.050	3.5	3.3	73 500	91 000	7 500	9 300	5 000	6 700
	80.167	29.370	30.391	23.812	0.8	3.3	92 500	108 000	9 450	11 000	4 800	6 300
40.000	80.000	21.000	22.403	17.826	3.5	1.3	68 500	75 500	6 950	7 700	4 500	6 300
	80.000	21.000	22.403	17.826	0.8	1.3	68 500	75 500	6 950	7 700	4 500	6 300
	88.501	25.400	23.698	17.462	2.3	1.5	73 000	81 000	7 450	8 250	4 000	5 600
41.000	68.000	17.500	18.000	13.500	spec.	1.5	43 500	58 000	4 450	5 950	5 300	7 100
41.275	73.025	16.667	17.462	12.700	3.5	1.5	44 500	54 000	4 550	5 500	4 800	6 700
	73.431	19.558	19.812	14.732	3.5	0.8	54 500	67 000	5 550	6 850	4 800	6 700
	73.431	21.430	19.812	16.604	3.5	0.8	54 500	67 000	5 550	6 850	4 800	6 700

Bearing Numbers		Abutment and Fillet Dimensions (mm)				Eff. Load Centers (mm)		Constant	Axial Load Factors		Mass (kg)		
CONE	CUP	<i>d_a</i>	<i>d_b</i>	<i>D_a</i>	<i>D_b</i>	Cone <i>r_a</i>	Cup <i>r_a</i>	<i>e</i>	<i>Y₁</i>	<i>Y₀</i>	approx. CONE	CUP	
HM 88648	HM 88610	52	43	60	69	3.5	2.3	20.7	0.55	1.1	0.60	0.298	0.188
25880	25821	44	42	65	68	1.5	0.8	15.7	0.29	2.1	1.1	0.291	0.167
HM 89449	HM 89410	54	44.5	62	73	3.5	3.3	23.6	0.55	1.1	0.60	0.38	0.257
3479	3420	45.5	44.5	67	74	0.8	3.3	20.0	0.37	1.6	0.90	0.429	0.259
44143	44348	54	50	75	84	2.3	1.5	27.9	0.78	0.77	0.42	0.502	0.245
46143	46368	48.5	46.5	79	87	1.5	3.3	24.0	0.40	1.5	0.82	0.765	0.405
▲ JL 69349	▲ JL 69310	49	42.5	56	60	3.5	1.3	14.6	0.42	1.4	0.79	0.132	0.071
13889	13830	45	42.5	59	60	1.5	0.8	11.9	0.35	1.7	0.95	0.109	0.046
LM 29749	LM 29710	46	42.5	59	62	2.3	1.3	13.7	0.33	1.8	0.99	0.16	0.079
LM 29748	LM 29710	49	42.5	59	62	3.5	1.3	13.7	0.33	1.8	0.99	0.158	0.079
LM 29749	LM 29711	46	42.5	58	62	2.3	1.3	15.5	0.33	1.8	0.99	0.16	0.094
19150	19268	45	43	61	65	1.5	1.5	14.5	0.44	1.4	0.74	0.173	0.073
13687	13621	46.5	43	61	65	2	2.3	15.8	0.40	1.5	0.82	0.193	0.104
13685	13620	49.5	43	62	65	3.5	0.8	15.8	0.40	1.5	0.82	0.191	0.105
16150	16284	49.5	43	63	67	3.5	1.3	16.0	0.40	1.5	0.82	0.212	0.146
2788	2735 X	50	43.5	66	69	3.5	0.8	15.9	0.30	2.0	1.1	0.312	0.135
2788	2720	50	43.5	66	70	3.5	3.3	15.9	0.30	2.0	1.1	0.312	0.187
2788	2729	50	43.5	68	70	3.5	0.8	15.9	0.30	2.0	1.1	0.312	0.191
3490	3420	52	45.5	67	74	3.5	3.3	20.0	0.37	1.6	0.90	0.404	0.259
27880	27820	48	47	68	75	0.8	1.5	21.5	0.56	1.1	0.59	0.362	0.209
HM 801346	HM 801310	51	49	68	78	0.8	3.3	24.2	0.55	1.1	0.60	0.483	0.282
44150	44348	55	51	75	84	2.3	1.5	27.9	0.78	0.77	0.42	0.484	0.245
418	414	51	44.5	77	80	3.5	1.5	17.1	0.26	2.3	1.3	0.50	0.329
53150	53375	55	53	81	89	1.5	0.8	30.7	0.74	0.81	0.45	0.665	0.365
M 201047	M 201011	45.5	48	64	69	0.8	2.3	19.7	0.33	1.8	0.99	0.266	0.169
2789	2720	52	45	66	70	3.5	3.3	15.9	0.30	2.0	1.1	0.292	0.187
3386	3320	46.5	45.5	70	75	0.8	3.3	18.4	0.27	2.2	1.2	0.442	0.217
344	332	52	45.5	73	75	3.5	1.3	14.5	0.27	2.2	1.2	0.338	0.146
344 A	332	46	45.5	73	75	0.8	1.3	14.5	0.27	2.2	1.2	0.339	0.146
44157	44348	56	51	75	84	2.3	1.5	27.9	0.78	0.77	0.42	0.463	0.245
* LM 300849	** LM 300811	52	45	61	65	3.5	1.5	13.9	0.35	1.7	0.95	0.16	0.082
18590	18520	53	46	66	69	3.5	1.5	14.0	0.35	1.7	0.94	0.199	0.086
LM 501349	LM 501310	53	46.5	67	70	3.5	0.8	16.3	0.40	1.5	0.83	0.226	0.108
LM 501349	LM 501314	53	46.5	66	70	3.5	0.8	18.2	0.40	1.5	0.83	0.226	0.129

- Notes
- * The maximum bore diameter is listed and its tolerance is negative (See Table 8.4.1 on Page A68).
 - ** The maximum outside diameter is listed and its tolerance is negative (See Table 8.4.2 on Pages A68 and A69).
 - ▲ The tolerances are listed in Tables 2, 3 and 4 on Pages B113 and B114.

SINGLE-ROW TAPERED ROLLER BEARINGS (INCH DESIGN)

Bore Diameter 41.275 – 44.450 mm

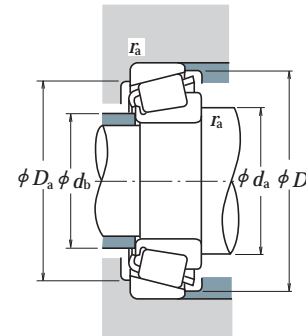
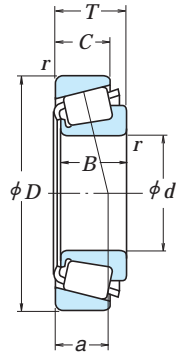

Dynamic Equivalent Load

$$P = XF_r + YF_a$$

$F_a / F_r \leq e$		$F_a / F_r > e$	
X	Y	X	Y
1	0	0.4	Y_1

Static Equivalent Load

$$P_0 = 0.5F_r + Y_0F_a$$

When $F_r > 0.5F_r + Y_0F_a$, use $P_0 = F_r$

The values of e , Y_1 , and Y_0 are given in the table below.

Boundary Dimensions (mm)					Basic Load Ratings (kgf)				Limiting Speeds (min ⁻¹)			
d	D	T	B	C	Cone r min.	Cup r min.	C_r	C_{0r}	C_r	C_{0r}	Grease	Oil
41.275	76.200	18.009	17.384	14.288	1.5	1.5	42 500	51 000	4 350	5 200	4 500	6 300
	76.200	22.225	23.020	17.462	3.5	0.8	66 000	82 000	6 700	8 400	4 800	6 700
	76.200	25.400	23.020	20.638	3.5	2.3	66 000	82 000	6 700	8 400	4 800	6 700
	79.375	23.812	25.400	19.050	3.5	0.8	77 000	98 500	7 850	10 000	4 800	6 300
	80.000	21.000	22.403	17.826	0.8	1.3	68 500	75 500	6 950	7 700	4 500	6 300
	80.000	21.000	22.403	17.826	3.5	1.3	68 500	75 500	6 950	7 700	4 500	6 300
	80.167	25.400	25.400	20.638	3.5	3.3	77 000	98 500	7 850	10 000	4 800	6 300
	82.550	26.543	25.654	20.193	3.5	3.3	78 500	102 000	8 000	10 400	4 300	6 000
	85.725	30.162	30.162	23.812	3.5	3.3	91 000	115 000	9 300	11 700	4 300	6 000
	87.312	30.162	30.886	23.812	0.8	3.3	96 000	120 000	9 800	12 200	4 300	6 000
42.862	88.501	25.400	23.698	17.462	2.3	1.5	73 000	81 000	7 450	8 250	4 000	5 600
	88.900	30.162	29.370	23.020	3.5	3.3	96 500	129 000	9 800	13 200	4 000	5 600
	88.900	30.162	29.370	23.020	0.8	3.3	96 500	129 000	9 800	13 200	4 000	5 600
	90.488	39.688	40.386	33.338	3.5	3.3	139 000	180 000	14 200	18 400	4 300	5 600
	93.662	31.750	31.750	26.195	0.8	3.3	110 000	142 000	11 200	14 400	4 000	5 600
	95.250	30.162	29.370	23.020	3.5	3.3	106 000	143 000	10 800	14 500	3 800	5 300
	98.425	30.958	28.301	20.638	1.5	0.8	87 500	97 000	8 950	9 850	3 600	5 300
	76.992	17.462	17.145	11.908	1.5	1.5	44 000	54 000	4 450	5 500	4 500	6 000
	82.550	19.842	19.837	15.080	2.3	1.5	58 500	69 000	5 950	7 050	4 500	6 300
	82.931	23.812	25.400	19.050	2.3	0.8	76 500	99 000	7 800	10 100	4 500	6 000
42.875	82.931	26.988	25.400	22.225	2.3	2.3	76 500	99 000	7 800	10 100	4 500	6 000
	83.058	23.812	25.400	19.050	3.5	3.3	76 500	99 000	7 800	10 100	4 500	6 000
	76.200	25.400	25.400	20.638	3.5	1.5	77 000	98 500	7 850	10 000	4 800	6 300
	80.000	21.000	22.403	17.826	3.5	1.3	68 500	75 500	6 950	7 700	4 500	6 300
43.000	82.931	26.988	25.400	22.225	3.5	2.3	76 500	99 000	7 800	10 100	4 500	6 000
	83.058	23.812	25.400	19.050	3.5	3.3	76 500	99 000	7 800	10 100	4 500	6 000
	74.988	19.368	19.837	14.288	1.5	1.3	52 500	68 000	5 350	6 900	4 800	6 300
44.450	80.962	19.050	17.462	14.288	0.3	1.5	45 000	57 000	4 600	5 800	4 300	6 000
	82.931	23.812	25.400	19.050	3.5	0.8	76 500	99 000	7 800	10 100	4 500	6 000
	83.058	23.812	25.400	19.050	3.5	3.3	76 500	99 000	7 800	10 100	4 500	6 000
	87.312	30.162	30.886	23.812	3.5	3.3	96 000	120 000	9 800	12 200	4 300	6 000
	88.900	30.162	29.370	23.020	3.5	3.3	96 500	129 000	9 800	13 200	4 000	5 600
	93.264	30.162	30.302	23.812	3.5	3.2	103 000	136 000	10 500	13 900	3 800	5 300
	93.662	31.750	31.750	25.400	0.8	3.3	120 000	147 000	12 200	15 000	4 000	5 600
	93.662	31.750	31.750	25.400	3.5	3.3	120 000	147 000	12 200	15 000	4 000	5 600
	93.662	31.750	31.750	26.195	3.5	3.3	110 000	142 000	11 200	14 400	4 000	5 600
	95.250	27.783	29.901	22.225	3.5	2.3	106 000	126 000	10 800	12 900	4 300	5 600

Bearing Numbers		Abutment and Fillet Dimensions (mm)				Eff. Load Centers (mm)		Constant	Axial Load Factors		Mass (kg)	
CONE	CUP	d_a	d_b	D_a	D_b	Cone r_a max.	Cup r_a max.	a	e	Y_1	Y_0	approx. CONE CUP
11162	11300	49	46.5	67	71	1.5	1.5	17.4	0.49	1.2	0.68	0.212 0.129
		53	47.5	68	72	3.5	0.8	17.0	0.39	1.5	0.84	0.279 0.15
		54	47	66	72	3.5	2.3	20.2	0.39	1.5	0.84	0.279 0.189
		54	47	71	74	3.5	0.8	16.4	0.32	1.9	1.0	0.349 0.186
		47	46	73	75	0.8	1.3	14.5	0.27	2.2	1.2	0.325 0.146
		53	46	73	75	3.5	1.3	14.5	0.27	2.2	1.2	0.323 0.146
		54	47	69	74	3.5	3.3	18.0	0.32	1.9	1.0	0.349 0.219
		57	51	70	79	3.5	3.3	22.9	0.55	1.1	0.60	0.406 0.23
		57	50	73	81	3.5	3.3	21.8	0.40	1.5	0.82	0.506 0.285
		49	48	75	81	0.8	3.3	19.5	0.31	2.0	1.1	0.532 0.304
HM 803146	HM 803110	57	51	75	84	2.3	1.5	28.0	0.78	0.77	0.42	0.447 0.245
		60	53	74	85	3.5	3.3	25.6	0.55	1.1	0.60	0.579 0.322
		54	53	74	85	0.8	3.3	25.6	0.55	1.1	0.60	0.582 0.322
		57	51	77	85	3.5	3.3	24.6	0.28	2.1	1.2	0.789 0.459
		52	51	79	87	0.8	3.3	24.0	0.40	1.5	0.82	0.695 0.405
		61	54	81	91	3.5	3.3	26.1	0.55	1.1	0.60	0.726 0.354
		57	53	82	91	1.5	0.8	30.7	0.74	0.81	0.45	0.618 0.442
		51	48.5	68	73	1.5	1.5	17.7	0.51	1.2	0.65	0.228 0.098
		52	48.5	73	76	2.3	1.5	17.6	0.43	1.4	0.77	0.283 0.176
		53	49.5	74	77	2.3	0.8	17.6	0.33	1.8	0.99	0.383 0.203
HM 804840	HM 804810	53	49.5	72	77	2.3	2.3	20.8	0.33	1.8	0.99	0.383 0.248
		55	48.5	69	73	3.5	1.5	18.0	0.32	1.9	1.0	0.337 0.136
		54	47.5	73	75	3.5	1.3	14.5	0.27	2.2	1.2	0.305 0.146
		55	49	72	77	3.5	2.3	20.8	0.33	1.8	0.99	0.381 0.248
		55	49	72	77	3.5	3.3	17.6	0.33	1.8	0.99	0.381 0.201
		51	48.5	67	71	1.5	1.3	17.2	0.44	1.4	0.74	0.24 0.106
		50	50	72	76	0.3	1.5	20.1	0.53	1.1	0.63	0.252 0.144
		57	50	74	77	3.5	0.8	17.6	0.33	1.8	0.99	0.359 0.203
		56	51	72	78	3.5	3.3	17.6	0.33	1.8	0.99	0.359 0.201
		57	51	75	81	3.5	3.3	19.5	0.31	2.0	1.1	0.477 0.304
HM 803149	HM 803110	62	53	74	85	3.5	3.3	25.6	0.55	1.1	0.60	0.528 0.322
		58	52	82	88	3.5	3.2	22.4	0.34	1.8	0.97	0.678 0.292
		54	53	82	87	0.8	3.3	21.6	0.36	1.7	0.92	0.648 0.371
		59	53	82	87	3.5	3.3	21.6	0.36	1.7	0.92	0.645 0.371
		60	54	79	87	3.5	3.3	24.0	0.40	1.5	0.82	0.635 0.405
		57	51	83	87	3.5	2.3	18.6	0.28	2.1	1.2	0.555 0.384

Note * The maximum bore diameter is listed and its tolerance is negative (See Table 8.4.1 on Page A68).

SINGLE-ROW TAPERED ROLLER BEARINGS (INCH DESIGN)

Bore Diameter 44.450 – 47.625 mm

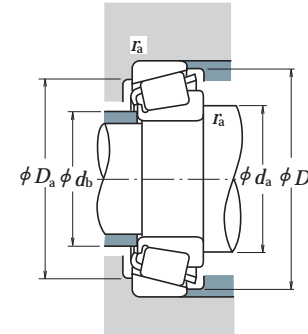
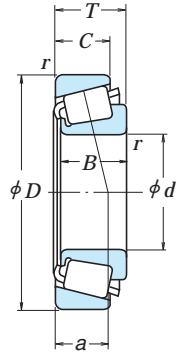

Dynamic Equivalent Load

$$P = XF_r + YF_a$$

$F_a / F_r \leq e$		$F_a / F_r > e$	
X	Y	X	Y
1	0	0.4	Y_1

Static Equivalent Load

$$P_0 = 0.5F_r + Y_0F_a$$

When $F_r > 0.5F_r + Y_0F_a$, use $P_0 = F_r$

The values of e , Y_1 , and Y_0 are given in the table below.

Boundary Dimensions (mm)					Cone		Basic Load Ratings (kgf)				Limiting Speeds (min ⁻¹)	
d	D	T	B	C	r	Cup min.	C _r	C _{0r}	C _r	C _{0r}	Grease	Oil
44.450	95.250	30.162	29.370	23.020	3.5	3.3	106 000	143 000	10 800	14 500	3 800	5 300
	95.250	30.958	28.301	20.638	3.5	0.8	87 500	97 000	8 950	9 850	3 600	5 300
	95.250	30.958	28.301	20.638	1.3	0.8	87 500	97 000	8 950	9 850	3 600	5 300
	95.250	30.958	28.301	20.638	2.0	0.8	87 500	97 000	8 950	9 850	3 600	5 300
	95.250	30.958	28.301	22.225	1.3	0.8	100 000	122 000	10 200	12 500	3 600	5 000
	95.250	30.958	28.575	22.225	3.5	0.8	100 000	122 000	10 200	12 500	3 600	5 000
	98.425	30.958	28.301	20.638	3.5	0.8	87 500	97 000	8 950	9 850	3 600	5 300
	103.188	43.658	44.475	36.512	1.3	3.3	178 000	238 000	18 100	24 300	3 800	5 000
	104.775	36.512	36.512	28.575	3.5	3.3	139 000	192 000	14 200	19 600	3 400	4 800
	107.950	27.783	29.317	22.225	3.5	0.8	116 000	149 000	11 800	15 200	3 400	4 800
44.983	111.125	30.162	26.909	20.638	3.5	3.3	92 500	110 000	9 450	11 200	3 200	4 300
	114.300	44.450	44.450	34.925	3.5	3.3	172 000	205 000	17 500	20 900	3 600	4 800
45.000	82.931	23.812	25.400	19.050	1.5	0.8	76 500	99 000	7 800	10 100	4 500	6 000
	93.264	20.638	22.225	15.082	0.8	1.3	77 000	93 000	7 900	9 500	3 800	5 300
45.230	79.985	19.842	20.638	15.080	2.0	1.3	62 000	78 500	6 300	8 000	4 500	6 000
	73.431	19.558	19.812	15.748	3.5	0.8	53 500	75 000	5 450	7 650	4 800	6 300
45.242	77.788	19.842	19.842	15.080	3.5	0.8	56 000	71 000	5 700	7 250	4 500	6 300
	77.788	21.430	19.842	16.667	3.5	0.8	56 000	71 000	5 700	7 250	4 500	6 300
45.618	82.931	23.812	25.400	19.050	3.5	0.8	76 500	99 000	7 800	10 100	4 500	6 000
	82.931	26.988	25.400	22.225	3.5	2.3	76 500	99 000	7 800	10 100	4 500	6 000
46.000	75.000	18.000	18.000	14.000	2.3	1.5	51 000	71 500	5 200	7 300	4 500	6 300
	79.375	17.462	17.462	13.495	2.8	1.5	46 000	57 000	4 700	5 800	4 500	6 000
46.038	80.962	19.050	17.462	14.288	0.8	1.5	45 000	57 000	4 600	5 800	4 300	6 000
	85.000	20.638	21.692	17.462	2.3	1.3	71 500	81 500	7 300	8 300	4 300	6 000
	85.000	25.400	25.608	20.638	3.5	1.3	79 500	105 000	8 100	10 700	4 300	6 000
	95.250	27.783	29.901	22.225	3.5	0.8	106 000	126 000	10 800	12 900	4 300	5 600
	88.900	20.638	22.225	16.513	3.5	1.3	73 000	85 000	7 450	8 650	4 000	5 600
47.625	88.900	25.400	25.400	19.050	3.5	3.3	86 000	107 000	8 750	10 900	4 000	5 600
	95.250	30.162	29.370	23.020	3.5	3.3	106 000	143 000	10 800	14 500	3 800	5 300
	101.600	34.925	36.068	26.988	3.5	3.3	137 000	169 000	14 000	17 200	3 800	5 000
	111.125	30.162	26.909	20.638	3.5	3.3	92 500	110 000	9 450	11 200	3 200	4 300
	112.712	30.162	26.909	20.638	3.5	3.3	92 500	110 000	9 450	11 200	3 200	4 300
	117.475	33.338	31.750	23.812	3.5	3.3	137 000	156 000	13 900	15 900	3 200	4 300
	123.825	36.512	32.791	25.400	3.5	3.3	143 000	160 000	14 600	16 400	3 000	4 000

Bearing Numbers		Abutment and Fillet Dimensions (mm)				Cone		Cup		Eff. Load Centers (mm)	Constant	Axial Load Factors		Mass (kg)	
CONE	CUP	d _a	d _b	D _a	D _b	r _a	r _{max}	a	e	Y ₁	Y ₀	approx.			
												CONE	CUP		
HM 804843	HM 804810	63	57	81	91	3.5	3.3	26.1	0.55	1.1	0.60	0.677	0.354		
	53177	53375	63	53	81	89	3.5	0.8	30.7	0.74	0.81	0.45	0.572	0.365	
	53176	53375	59	53	81	89	1.3	0.8	30.7	0.74	0.81	0.45	0.574	0.365	
	53178	53375	60	53	81	89	2	0.8	30.7	0.74	0.81	0.45	0.574	0.365	
	HM 903247	HM 903210	61	54	81	91	1.3	0.8	31.5	0.74	0.81	0.45	0.651	0.389	
	HM 903249	HM 903210	65	54	81	91	3.5	0.8	31.5	0.74	0.81	0.45	0.635	0.389	
	53177	53387	63	53	82	91	3.5	0.8	30.7	0.74	0.81	0.45	0.568	0.442	
	5356	5335	58	56	89	97	1.3	3.3	27.0	0.30	2.0	1.1	1.23	0.637	
	HM 807040	HM 807010	66	59	89	100	3.5	3.3	29.7	0.49	1.2	0.68	1.14	0.502	
	460	453 A	60	54	97	100	3.5	0.8	20.7	0.34	1.8	0.98	0.93	0.42	
55175	55437	67	60	92	105	3.5	3.3	37.3	0.88	0.68	0.37	0.867	0.514		
65385	65320	65	59	97	107	3.5	3.3	32.2	0.43	1.4	0.77	1.39	0.894		
25584	25520	53	51	74	77	1.5	0.8	17.6	0.33	1.8	0.99	0.354	0.203		
376	374	54	54	85	88	0.8	1.3	17.1	0.34	1.8	0.97	0.492	0.174		
17887	17831	57	52	68	74	2	1.3	15.9	0.37	1.6	0.90	0.274	0.136		
LM 102949	LM 102910	56	50	68	70	3.5	0.8	14.6	0.31	2.0	1.1	0.213	0.102		
LM 603049	LM 603011	57	50	71	74	3.5	0.8	17.2	0.43	1.4	0.77	0.249	0.119		
LM 603049	LM 603012	57	50	70	74	3.5	0.8	18.8	0.43	1.4	0.77	0.249	0.137		
25590	25520	58	51	74	77	3.5	0.8	17.6	0.33	1.8	0.99	0.343	0.203		
25590	25523	58	51	72	77	3.5	2.3	20.8	0.33	1.8	0.99	0.343	0.248		
* LM 503349	** LM 503310	55	51	67	71	2.3	1.5	15.9	0.40	1.5	0.82	0.209	0.096		
18690	18620	56	51	71	74	2.8	1.5	15.5	0.37	1.6	0.88	0.211	0.126		
13181	13318	52	52	72	76	0.8	1.5	20.1	0.53	1.1	0.63	0.236	0.144		
359 S	354 A	55	51	77	80	2.3	1.3	15.4	0.31	2.0	1.1	0.343	0.162		
2984	2924	58	52	76	80	3.5	1.3	19.0	0.35	1.7	0.95	0.397	0.223		
436	432 A	59	52	84	87	3.5	0.8	18.6	0.28	2.1	1.2	0.536	0.381		
369 A	362 A	60	53	81	84	3.5	1.3	16.6	0.32	1.9	1.0	0.381	0.166		
M 804049	M 804010	63	56	77	85	3.5	3.3	23.8	0.55	1.1	0.60	0.455	0.218		
HM 804846	HM 804810	66	57	81	91	3.5	3.3	26.1	0.55	1.1	0.60	0.626	0.354		
528	522	62	55	89	95	3.5	3.3	22.1	0.29	2.1	1.2	0.894	0.416		
55187	55437	69	62	92	105	3.5	3.3	37.3	0.88	0.68	0.37	0.817	0.514		
55187	55443	69	62	92	106	3.5	3.3	37.3	0.88	0.68	0.37	0.816	0.554		
66187	66462	66	62	100	111	3.5	3.3	32.1	0.63	0.96	0.53	1.19	0.552		
72187	72487	72	66	102	116	3.5	3.3	37.0	0.74	0.81	0.45	1.29	0.79		

Notes * The maximum bore diameter is listed and its tolerance is negative (See Table 8.4.1 on Page A68).
 ** The maximum outside diameter is listed and its tolerance is negative (See Table 8.4.2 on Pages A68 and A69).

SINGLE-ROW TAPERED ROLLER BEARINGS (INCH DESIGN)

Bore Diameter 48.412 – 52.388 mm

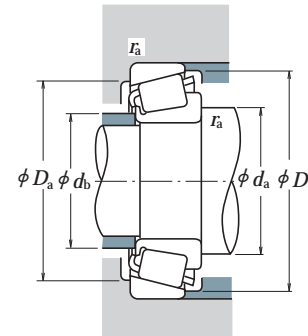
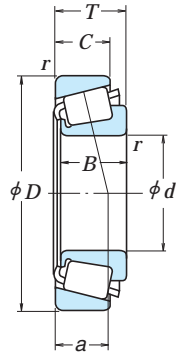

Dynamic Equivalent Load

$$P = XF_r + YF_a$$

$F_a / F_r \leq e$		$F_a / F_r > e$	
X	Y	X	Y
1	0	0.4	Y_1

Static Equivalent Load

$$P_0 = 0.5F_r + Y_0F_a$$

When $F_r > 0.5F_r + Y_0F_a$, use $P_0 = F_r$

The values of e , Y_1 , and Y_0 are given in the table below.

Boundary Dimensions (mm)					Cone		Basic Load Ratings (N)				Limiting Speeds (min ⁻¹)	
d	D	T	B	C	r	Cup min.	C_r	C_{0r}	C_r	C_{0r}	Grease	Oil
48.412	95.250	30.162	29.370	23.020	3.5	3.3	106 000	143 000	10 800	14 500	3 800	5 300
	95.250	30.162	29.370	23.020	2.3	3.3	106 000	143 000	10 800	14 500	3 800	5 300
49.212	104.775	36.512	36.512	28.575	3.5	0.8	139 000	192 000	14 200	19 600	3 400	4 800
	114.300	44.450	44.450	36.068	3.5	3.3	196 000	243 000	20 000	24 800	3 400	4 800
50.000	82.000	21.500	21.500	17.000	3.0	0.5	71 000	96 000	7 250	9 800	4 300	5 600
	82.550	21.590	22.225	16.510	0.5	1.3	71 000	96 000	7 250	9 800	4 300	5 600
	88.900	20.638	22.225	16.513	2.3	1.3	73 000	85 000	7 450	8 650	4 000	5 600
50.800	90.000	28.000	28.000	23.000	3.0	2.5	104 000	136 000	10 600	13 900	4 000	5 600
	105.000	37.000	36.000	29.000	3.0	2.5	139 000	192 000	14 200	19 600	3 400	4 800
52.388	92.075	24.608	25.400	19.845	3.5	0.8	84 500	117 000	8 600	11 900	4 000	5 300
	104.775	36.512	36.512	28.575	3.5	0.8	139 000	192 000	14 200	19 600	3 400	4 800

Bearing Numbers		Abutment and Fillet Dimensions (mm)				Eff. Load Centers (mm)		Constant	Axial Load Factors		Mass (kg)		
CONE	CUP	d_a	d_b	D_a	D_b	r_a	a	e	Y_1	Y_0	approx. CONE	CUP	
HM 804849	HM 804810	66	57	81	91	3.5	3.3	26.1	0.55	1.1	0.60	0.61	0.354
HM 804848	HM 804810	63	57	81	91	2.3	3.3	26.1	0.55	1.1	0.60	0.614	0.354
HM 807044	HM 807011	69	63	91	100	3.5	0.8	29.7	0.49	1.2	0.68	1.03	0.508
HH 506348	HH 506310	71	61	97	107	3.5	3.3	30.8	0.40	1.5	0.82	1.43	0.837
▲ JLM 104948	▲ JLM 104910	60	55	76	78	3	0.5	16.1	0.31	2.0	1.1	0.306	0.129
* LM 104947 A	LM 104911	55	55	75	78	0.5	1.3	15.7	0.31	2.0	1.1	0.316	0.133
366	362 A	59	55	81	84	2.3	1.3	16.6	0.32	1.9	1.0	0.351	0.166
▲ JM 205149	▲ JM 205110	62	57	80	85	3	2.5	19.9	0.33	1.8	1.0	0.507	0.246
▲ JHM 807045	▲ JHM 807012	69	63	90	100	3	2.5	29.7	0.49	1.2	0.68	1.01	0.523
L 305649	L 305610	58	56	73	77	1.5	1.5	15.7	0.36	1.7	0.93	0.239	0.119
LM 104949	LM 104911 A	62	55	75	78	3.5	0.8	17.8	0.31	2.0	1.1	0.303	0.156
LM 104949	LM 104912	62	55	75	78	3.5	1.3	15.7	0.31	2.0	1.1	0.301	0.14
18790	18720	62	56	77	80	3.5	1.5	16.7	0.41	1.5	0.81	0.239	0.136
18200	18337	59	56	76	81	1.5	1.5	21.0	0.57	1.1	0.58	0.268	0.136
368 A	362 A	62	56	81	84	3.5	1.3	16.6	0.32	1.9	1.0	0.338	0.166
368	362 A	58	56	81	84	1.5	1.3	16.6	0.32	1.9	1.0	0.341	0.166
28580	28521	63	57	83	87	3.5	0.8	20.0	0.38	1.6	0.87	0.46	0.247
3775	3730	58	58	84	88	0.8	0.8	22.4	0.34	1.8	0.97	0.568	0.297
3780	3730	64	58	84	88	3.5	0.8	22.4	0.34	1.8	0.97	0.564	0.297
33889	33821	64	58	85	90	3.5	2.3	19.8	0.33	1.8	1.0	0.601	0.267
49585	49520	66	59	88	96	3.5	3.3	23.4	0.40	1.5	0.82	0.744	0.389
529	522	59	58	89	95	0.8	3.3	22.1	0.29	2.1	1.2	0.822	0.416
529 X	522	65	58	89	95	3.5	3.3	22.1	0.29	2.1	1.2	0.819	0.416
HM 807046	HM 807011	70	63	91	100	3.5	0.8	29.7	0.49	1.2	0.68	0.992	0.508
HM 807046	HM 807010	70	63	89	100	3.5	3.3	29.7	0.49	1.2	0.68	0.993	0.502
59200	59429	68	61	93	101	3.5	3.3	25.4	0.40	1.5	0.82	0.943	0.594
55200 C	55437	71	65	92	105	3.5	3.3	37.6	0.88	0.68	0.37	0.845	0.514
55200	55437	71	64	92	105	3.5	3.3	37.3	0.88	0.68	0.37	0.767	0.514
72200 C	72487	77	67	102	116	3.5	3.3	38.0	0.74	0.81	0.45	1.33	0.79
72200	72487	74	66	102	116	3.5	3.3	37.0	0.74	0.81	0.45	1.22	0.79
65200	65500	75	69	107	119	3.5	3.3	35.0	0.49	1.2	0.68	1.86	1.03
6279	6220	71	65	108	117	3.5	3.3	30.7	0.30	2.0	1.1	2.08	1.22
28584	28521	65	58	83	87	3.5	0.8	20.0	0.38	1.6	0.87	0.435	0.247
377	372	62	58	86	90	2.3	2	21.4	0.34	1.8	0.97	0.392	0.435
55206	55437	72	64	92	105	3.5	3.3	37.3	0.88	0.68	0.37	0.737	0.514

Notes * The maximum bore diameter is listed and its tolerance is negative (See Table 8.4.1 on Page A68).

▲ The tolerances are listed in Tables 2, 3 and 4 on Pages B113 and B114.

SINGLE-ROW TAPERED ROLLER BEARINGS (INCH DESIGN)

Bore Diameter 53.975 – 58.738 mm

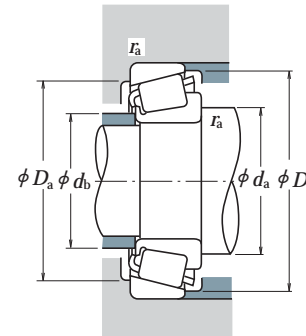
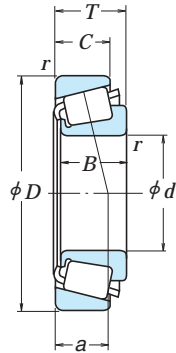

Dynamic Equivalent Load

$$P = XF_r + YF_a$$

$F_a/F_r \leq e$		$F_a/F_r > e$	
X	Y	X	Y
1	0	0.4	Y_1

Static Equivalent Load

$$P_0 = 0.5F_r + Y_0F_a$$

When $F_r > 0.5F_r + Y_0F_a$, use $P_0 = F_r$

The values of e , Y_1 , and Y_0 are given in the table below.

Boundary Dimensions (mm)					Cone		Basic Load Ratings (kgf)				Limiting Speeds (min ⁻¹)	
d	D	T	B	C	r	Cup min.	C_r	C_{0r}	C_r	C_{0r}	Grease	Oil
53.975	104.775	39.688	40.157	33.338	3.5	3.3	148 000	207 000	15 100	21 100	3 600	4 800
	107.950	36.512	36.957	28.575	3.5	3.3	144 000	182 000	14 700	18 500	3 600	4 800
	122.238	33.338	31.750	23.812	3.5	3.3	135 000	156 000	13 800	15 900	3 000	4 000
	123.825	36.512	32.791	25.400	3.5	3.3	143 000	160 000	14 600	16 400	3 000	4 000
	123.825	36.512	32.791	25.400	3.5	3.3	162 000	199 000	16 500	20 300	2 800	4 000
	123.825	38.100	36.678	30.162	3.5	3.3	161 000	221 000	16 400	22 500	3 000	4 000
	127.000	44.450	44.450	34.925	3.5	3.3	199 000	258 000	20 200	26 300	3 000	4 000
	127.000	50.800	52.388	41.275	3.5	3.3	236 000	300 000	24 000	31 000	3 200	4 300
	130.175	36.512	33.338	23.812	3.5	3.3	133 000	154 000	13 600	15 700	2 600	3 600
	55.000	90.000	23.000	23.000	18.500	1.5	0.5	79 000	111 000	8 050	11 300	3 800
95.000		29.000	29.000	23.500	1.5	2.5	111 000	152 000	11 300	15 500	3 800	5 000
96.838		21.000	21.946	15.875	2.3	0.8	80 500	100 000	8 200	10 200	3 600	5 000
110.000	39.000	39.000	32.000	3.0	2.5	177 000	225 000	18 000	23 000	3 400	4 500	
	115.000	41.021	41.275	31.496	3.0	3.0	172 000	214 000	17 500	21 800	3 200	4 500
55.562	97.630	24.608	24.608	19.446	3.5	0.8	89 000	129 000	9 100	13 100	3 600	5 000
	122.238	43.658	43.764	36.512	1.3	3.3	198 000	292 000	20 200	29 700	3 000	4 000
	123.825	36.512	32.791	25.400	3.5	3.3	143 000	160 000	14 600	16 400	3 000	4 000
	123.825	36.512	32.791	25.400	3.5	3.3	162 000	199 000	16 500	20 300	2 800	4 000
57.150	96.838	21.000	21.946	15.875	3.5	0.8	80 500	100 000	8 200	10 200	3 600	5 000
	96.838	21.000	21.946	15.875	2.3	0.8	80 500	100 000	8 200	10 200	3 600	5 000
	96.838	25.400	21.946	20.275	3.5	2.3	80 500	100 000	8 200	10 200	3 600	5 000
	98.425	21.000	21.946	17.826	3.5	0.8	80 500	100 000	8 200	10 200	3 600	5 000
	104.775	30.162	29.317	24.605	3.5	3.3	116 000	149 000	11 800	15 200	3 400	4 800
	104.775	30.162	29.317	24.605	2.3	3.3	116 000	149 000	11 800	15 200	3 400	4 800
	104.775	30.162	30.958	23.812	0.8	3.3	130 000	170 000	13 300	17 400	3 400	4 800
	104.775	30.162	30.958	23.812	0.8	0.8	130 000	170 000	13 300	17 400	3 400	4 800
	122.238	33.338	31.750	23.812	3.5	3.3	135 000	156 000	13 800	15 900	3 000	4 000
	123.825	36.512	32.791	25.400	3.5	3.3	162 000	199 000	16 500	20 300	2 800	4 000
123.825	38.100	36.678	30.162	3.5	3.3	161 000	221 000	16 400	22 500	3 000	4 000	
140.030	36.512	33.236	23.520	3.5	2.3	152 000	183 000	15 500	18 700	2 600	3 600	
144.983	36.000	33.236	23.007	3.5	3.5	152 000	183 000	15 500	18 700	2 600	3 600	
149.225	53.975	54.229	44.450	3.5	3.3	287 000	410 000	29 300	41 500	2 600	3 400	
57.531	96.838	21.000	21.946	15.875	3.5	0.8	80 500	100 000	8 200	10 200	3 600	5 000
	58.738	112.712	33.338	30.048	26.988	3.5	3.3	120 000	173 000	12 200	17 700	3 200

Bearing Numbers		Abutment and Fillet Dimensions (mm)				Cone Cup		Eff. Load Centers (mm)	Constant	Axial Load Factors		Mass (kg)		
CONE	CUP	d_a	d_b	D_a	D_b	r_a	Cup max.	a	e	Y_1	Y_0	approx. CONE CUP		
4595	4535	70	63	90	99	3.5	3.3	27.4	0.34	1.79	0.98	0.989	0.589	
	539	532 X	68	61	94	100	3.5	3.3	24.3	0.30	2.0	1.1	0.88	0.57
	66584	66520	75	68	105	116	3.5	3.3	34.3	0.67	0.90	0.50	1.2	0.558
	72212	72487	77	66	102	116	3.5	3.3	37.0	0.74	0.81	0.45	1.16	0.79
	72212 C	72487	79	67	102	116	3.5	3.3	38.0	0.74	0.81	0.45	1.27	0.79
	557 S	552 A	71	65	109	116	3.5	3.3	28.8	0.35	1.7	0.95	1.49	0.764
	65212	65500	77	71	107	119	3.5	3.3	35.0	0.49	1.2	0.68	1.76	1.03
	6280	6220	74	67	108	117	3.5	3.3	30.7	0.30	2.0	1.1	1.97	1.22
	HM911242	HM911210	79	74	109	124	3.5	3.3	42.2	0.82	0.73	0.40	1.45	0.725
	▲ JLM506849	▲ JLM506810	63	61	82	86	1.5	0.5	19.7	0.40	1.5	0.82	0.378	0.186
▲ JM207049	▲ JM207010	64	62	85	91	1.5	2.5	21.3	0.33	1.8	0.99	0.59	0.26	
385	382 A	65	61	89	92	2.3	0.8	17.6	0.35	1.7	0.93	0.455	0.179	
▲ JH307749	▲ JH307710	71	64	97	104	3	2.5	27.2	0.35	1.7	0.95	1.13	0.567	
622 X	614 X	70	64	101	108	3	3	26.6	0.31	1.9	1.1	1.3	0.597	
28680	28622	68	62	88	92	3.5	0.8	21.3	0.40	1.5	0.82	0.499	0.27	
5566	5535	70	68	106	116	1.3	3.3	29.9	0.36	1.7	0.92	1.76	0.815	
72218	72487	78	66	102	116	3.5	3.3	37.0	0.74	0.81	0.45	1.12	0.79	
72218 C	72487	80	67	102	116	3.5	3.3	38.0	0.74	0.81	0.45	1.23	0.79	
387 A	382 A	69	62	89	92	3.5	0.8	17.6	0.35	1.7	0.93	0.42	0.179	
387	382 A	66	62	89	92	2.3	0.8	17.6	0.35	1.7	0.93	0.423	0.179	
387 A	382 S	69	62	87	91	3.5	2.3	22.0	0.35	1.7	0.93	0.42	0.249	
387 A	382	69	62	90	92	3.5	0.8	17.6	0.35	1.7	0.93	0.42	0.226	
469	453 X	70	63	92	98	3.5	3.3	23.1	0.34	1.8	0.98	0.692	0.376	
462	453 X	67	63	92	98	2.3	3.3	23.1	0.34	1.8	0.98	0.694	0.376	
45289	45220	65	65	93	99	0.8	3.3	21.9	0.33	1.8	0.99	0.752	0.347	
45289	45221	65	65	95	99	0.8	0.8	21.9	0.33	1.8	0.99	0.76	0.35	
66587	66520	77	71	105	116	3.5	3.3	34.3	0.67	0.90	0.50	1.14	0.558	
72225 C	72487	81	67	102	116	3.5	3.3	38.0	0.74	0.81	0.45	1.19	0.79	
555 S	552 A	83	68	109	116	3.5	3.3	28.8	0.35	1.7	0.95	1.41	0.764	
78225	78551	83	77	117	132	3.5	2.3	44.2	0.87	0.69	0.38	1.67	0.926	
78225	78571	83	77	118	132	3.5	3.5	43.6	0.87	0.69	0.38	1.68	1.08	
6455	6420	81	75	129	140	3.5	3.3	39.0	0.36	1.7	0.91	3.49	1.63	
388 A	382 A	69	63	89	92	3.5	0.8	17.6	0.35	1.7	0.93	0.416	0.179	
3981	3926	73	67	98	106	3.5	3.3	28.7	0.40	1.5	0.82	0.899	0.541	

Note ▲ The tolerances are listed in Tables 2, 3 and 4 on Pages B113 and B114.

SINGLE-ROW TAPERED ROLLER BEARINGS (INCH DESIGN)

Bore Diameter 60.000 – 64.963 mm

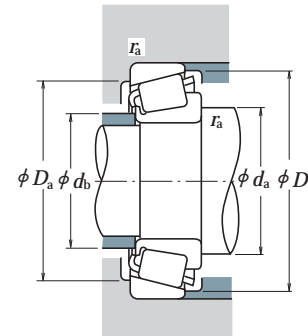
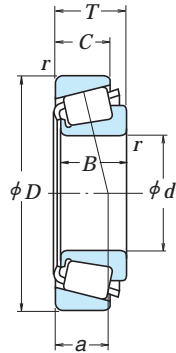

Dynamic Equivalent Load

$$P = XF_r + YF_a$$

$F_a / F_r \leq e$		$F_a / F_r > e$	
X	Y	X	Y
1	0	0.4	Y_1

Static Equivalent Load

$P_0 = 0.5F_r + Y_0F_a$
 When $F_r > 0.5F_r + Y_0F_a$, use $P_0 = F_r$
 The values of e , Y_1 , and Y_0 are given in the table below.

Boundary Dimensions (mm)						Basic Load Ratings (kgf)				Limiting Speeds (min ⁻¹)	
d	D	T	B	C	Cone Cup r min.	C _r	C _{0r}	C _r	C _{0r}	Grease	Oil
60.000	95.000	24.000	24.000	19.000	5.0 2.5	86 500	125 000	8 800	12 800	3 600	5 000
	104.775	21.433	22.000	15.875	2.3 2.0	83 500	107 000	8 500	10 900	3 400	4 500
	110.000	22.000	21.996	18.824	0.8 1.3	85 500	113 000	8 750	11 500	3 200	4 300
	122.238	33.338	31.750	23.812	3.5 3.3	135 000	156 000	13 800	15 900	3 000	4 000
60.325	100.000	25.400	25.400	19.845	3.5 3.3	91 000	135 000	9 250	13 700	3 400	4 800
	101.600	25.400	25.400	19.845	3.5 3.3	91 000	135 000	9 250	13 700	3 400	4 800
	122.238	38.100	36.678	30.162	2.3 3.3	161 000	221 000	16 400	22 500	3 000	4 000
	122.238	38.100	38.354	29.718	8.0 1.5	188 000	245 000	19 200	25 000	3 000	4 000
61.912	101.600	25.400	25.400	19.845	3.5 3.3	91 000	135 000	9 250	13 700	3 400	4 800
	122.238	43.658	43.764	36.512	0.8 3.3	198 000	292 000	20 200	29 700	3 000	4 000
	127.000	44.450	44.450	34.925	3.5 3.3	199 000	258 000	20 200	26 300	3 000	4 000
	130.175	41.275	41.275	31.750	3.5 3.3	195 000	263 000	19 800	26 800	2 800	3 800
63.500	104.775	21.433	22.000	15.875	2.0 2.0	83 500	107 000	8 500	10 900	3 400	4 500
	107.950	25.400	25.400	19.050	1.5 3.3	90 000	138 000	9 150	14 100	3 200	4 300
	110.000	22.000	21.996	18.824	3.5 1.3	85 500	113 000	8 750	11 500	3 200	4 300
	110.000	22.000	21.996	18.824	1.5 1.3	85 500	113 000	8 750	11 500	3 200	4 300
64.963	127.000	36.512	36.170	28.575	3.5 3.3	166 000	234 000	16 900	23 900	2 800	3 800

Bearing Numbers		Abutment and Fillet Dimensions (mm)				Eff. Load Centers (mm)		Constant	Axial Load Factors		Mass (kg)		
CONE	CUP	d _a	d _b	D _a	D _b	a	e	Y ₁	Y ₀	approx.			
				Cone Cup r _a max.						CONE	CUP		
▲ JLM 508748 * 39236 397 66585	▲ JLM 508710 39412 394 A 66520	75	66	85	91	5	2.5	21.6	0.40	1.5	0.82	0.43	0.20
		71	67	96	100	2.3	2	20.0	0.39	1.5	0.85	0.559	0.186
		69	68	101	104	0.8	1.3	20.9	0.40	1.5	0.82	0.642	0.263
		79	73	105	116	3.5	3.3	34.3	0.67	0.90	0.50	1.07	0.558
28985 28985 558	28921 28920 553 X	73	67	89	96	3.5	3.3	22.9	0.43	1.4	0.78	0.538	0.232
		73	67	90	97	3.5	3.3	22.9	0.43	1.4	0.78	0.538	0.272
		73	69	108	115	2.3	3.3	28.8	0.35	1.7	0.95	1.33	0.692
		85	70	110	116	8	1.5	27.0	0.34	1.8	0.98	1.43	0.604
HM 212044 5582 65237	HM 212010 5535 65500	73	72	106	116	0.8	3.3	29.9	0.36	1.7	0.92	1.61	0.815
		82	71	107	119	3.5	3.3	35.0	0.49	1.2	0.68	1.56	1.03
		78	72	116	124	3.5	3.3	29.9	0.36	1.7	0.91	1.87	0.712
		81	74	117	126	3.5	3.3	35.0	0.32	1.8	1.0	2.45	1.39
H 715334 H 913842 9180	H 715311 H 913810 9121	84	78	119	132	3.5	3.3	37.1	0.47	1.3	0.70	2.51	0.961
		90	82	124	138	3.5	3.3	44.4	0.78	0.77	0.42	2.2	0.898
		90	81	130	145	3.5	3.3	44.3	0.66	0.92	0.50	2.77	1.21
		71	69	86	91	1.5	1.5	19.6	0.42	1.4	0.78	0.306	0.154
L 610549 39250 29586	L 610510 39412 29520	73	69	96	100	2	2	20.0	0.39	1.5	0.85	0.501	0.186
		73	71	96	103	1.5	3.3	24.0	0.46	1.3	0.72	0.661	0.281
		77	70	101	104	3.5	1.3	20.9	0.40	1.5	0.82	0.58	0.263
		73	70	101	104	1.5	1.3	20.9	0.40	1.5	0.82	0.583	0.263
395 390 A 3982	394 A 394 A 3920	77	71	99	106	3.5	3.2	25.5	0.40	1.5	0.82	0.789	0.454
		77	71	101	107	3.5	3.3	23.5	0.34	1.8	0.97	0.899	0.359
		78	71	98	106	3.5	3.3	28.7	0.40	1.5	0.82	0.789	0.541
		87	73	108	116	7	3.3	26.9	0.34	1.8	0.98	1.34	0.598
HM 212047 HM 212046 5584	HM 212010 HM 212010 5535	87	73	110	116	7	1.5	26.9	0.34	1.8	0.98	1.34	0.604
		80	73	110	116	3.5	1.5	26.9	0.34	1.8	0.98	1.35	0.604
		81	75	106	116	3.5	3.3	29.9	0.36	1.7	0.92	1.5	0.815
		78	73	109	116	3.5	3.3	28.8	0.35	1.7	0.95	1.23	0.764
559 565 639	522 A 563 633	80	73	112	120	3.5	3.3	28.3	0.36	1.6	0.91	1.46	0.655
		81	74	116	124	3.5	3.3	29.9	0.36	1.7	0.91	1.77	0.712
		85	79	115	130	2.3	3.3	44.2	0.87	0.69	0.38	1.51	0.782
		79	76	119	125	3.5	3.3	29.9	0.36	1.7	0.91	1.77	1.04
78250 639 78250	78537 632 78551	85	79	117	132	2.3	2.3	44.2	0.87	0.69	0.38	1.51	0.926
		81	74	112	120	3.5	3.3	28.3	0.36	1.6	0.91	1.41	0.655

Notes * The maximum bore diameter is listed and its tolerance is negative (See Table 8.4.1 on Page A68).

▲ The tolerances are listed in Tables 2, 3 and 4 on Pages B113 and B114.

SINGLE-ROW TAPERED ROLLER BEARINGS (INCH DESIGN)

Bore Diameter 65.000 – 69.850 mm

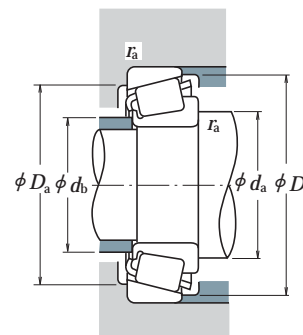
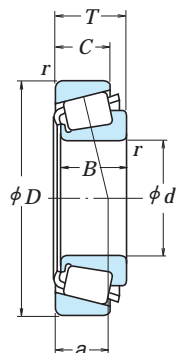

Dynamic Equivalent Load

$$P = X F_r + Y F_a$$

$F_a / F_r \leq e$		$F_a / F_r > e$	
X	Y	X	Y
1	0	0.4	Y_1

Static Equivalent Load

$$P_0 = 0.5 F_r + Y_0 F_a$$

When $F_r > 0.5 F_r + Y_0 F_a$, use $P_0 = F_r$

The values of e , Y_1 , and Y_0 are given in the table below.

Boundary Dimensions (mm)					Basic Load Ratings (N) (kgf)				Limiting Speeds (min ⁻¹)			
d	D	T	B	C	Cone r	Cup r	C _r	C _{0r}	C _r	C _{0r}	Grease	Oil
65.000	105.000	24.000	23.000	18.500	3.0	1.0	93 000	126 000	9 500	12 900	3 400	4 500
	110.000	28.000	28.000	22.500	3.0	2.5	120 000	173 000	12 200	17 700	3 200	4 300
	120.000	29.002	29.007	23.444	2.3	3.3	123 000	169 000	12 500	17 200	3 000	4 000
	120.000	39.000	38.500	32.000	3.0	2.5	185 000	249 000	18 800	25 400	3 000	4 000
65.088	135.755	53.975	56.007	44.450	3.5	3.3	264 000	355 000	27 000	36 000	2 800	3 800
	136.525	46.038	46.038	36.512	3.5	3.3	233 000	370 000	23 800	37 500	2 600	3 400
66.675	110.000	22.000	21.996	18.824	0.8	1.3	85 500	113 000	8 750	11 500	3 200	4 300
	110.000	22.000	21.996	18.824	3.5	1.3	85 500	113 000	8 750	11 500	3 200	4 300
	112.712	30.162	30.048	23.812	3.5	3.2	120 000	173 000	12 200	17 700	3 200	4 300
	112.712	30.162	30.162	23.812	5.5	3.2	120 000	173 000	12 200	17 700	3 200	4 300
	112.712	30.162	30.162	23.812	3.5	0.8	142 000	202 000	14 500	20 600	3 200	4 300
	112.712	30.162	30.162	23.812	3.5	3.3	142 000	202 000	14 500	20 600	3 200	4 300
	117.475	30.162	30.162	23.812	3.5	3.3	119 000	179 000	12 200	18 300	3 000	4 000
	122.238	38.100	36.678	30.162	3.5	3.3	161 000	221 000	16 400	22 500	3 000	4 000
	122.238	38.100	38.354	29.718	3.5	1.5	188 000	245 000	19 200	25 000	3 000	4 000
	122.238	38.100	38.354	29.718	3.5	3.3	188 000	245 000	19 200	25 000	3 000	4 000
	123.825	38.100	36.678	30.162	3.5	3.3	161 000	221 000	16 400	22 500	3 000	4 000
	136.525	46.038	46.038	36.512	3.5	3.3	233 000	370 000	23 800	37 500	2 600	3 400
68.262	110.000	22.000	21.996	18.824	2.3	1.3	85 500	113 000	8 750	11 500	3 200	4 300
	120.000	29.795	29.007	24.237	3.5	2.0	123 000	169 000	12 500	17 200	3 000	4 000
	122.238	38.100	36.678	30.162	3.5	3.3	161 000	221 000	16 400	22 500	3 000	4 000
	127.000	36.512	36.170	28.575	3.5	3.3	166 000	234 000	16 900	23 900	2 800	3 800
	136.525	41.275	41.275	31.750	3.5	3.3	229 000	297 000	23 300	30 500	2 600	3 600
	136.525	46.038	46.038	36.512	3.5	3.3	233 000	370 000	23 800	37 500	2 600	3 400
	152.400	47.625	46.038	31.750	3.5	3.3	237 000	267 000	24 200	27 300	2 400	3 400
	152.400	47.625	46.038	31.750	3.5	3.3	237 000	267 000	24 200	27 300	2 400	3 400
69.850	112.712	22.225	21.996	15.875	1.5	0.8	85 000	113 000	8 650	11 500	3 000	4 000
	112.712	25.400	25.400	19.050	1.5	3.3	96 000	152 000	9 800	15 500	2 800	4 000
	117.475	30.162	30.162	23.812	3.5	3.3	119 000	179 000	12 200	18 300	3 000	4 000
	120.000	32.545	32.545	26.195	3.5	3.3	152 000	225 000	15 500	22 900	3 000	4 000
	120.650	25.400	25.400	19.050	1.5	3.3	96 000	152 000	9 800	15 500	2 800	4 000
	127.000	36.512	36.170	28.575	3.5	0.8	166 000	234 000	16 900	23 900	2 800	3 800
	130.175	41.275	41.275	31.750	3.5	3.3	195 000	263 000	19 800	26 800	2 800	3 800
	146.050	41.275	39.688	25.400	3.5	3.3	193 000	225 000	19 700	22 900	2 400	3 400
	146.050	41.275	41.275	31.750	3.5	3.3	207 000	296 000	21 100	30 000	2 400	3 200
	149.225	53.975	54.229	44.450	5.0	3.3	287 000	410 000	29 300	41 500	2 600	3 400
	150.089	44.450	46.672	36.512	3.5	3.3	265 000	370 000	27 000	37 500	2 400	3 200

Bearing Numbers		Abutment and Fillet Dimensions (mm)				Eff. Load Centers (mm)		Constant	Axial Load Factors		Mass (kg)	
CONE	CUP	d _a	d _b	D _a	D _b	Cone r _a	Cup r _b	e	Y ₁	Y ₀	approx. CONE	CUP
▲ JLM 710949	▲ JLM 710910	77	71	96	101	3	1	23.7	0.45	1.3	0.526	0.237
▲ JM 511946	▲ JM 511910	78	72	99	105	3	2.5	24.5	0.40	1.5	0.72	0.342
478	472 A	77	73	106	114	2.3	3.3	24.3	0.38	1.6	0.86	0.942
▲ JH 211749	▲ JH 211710	80	74	107	114	3	2.5	27.9	0.34	1.8	0.98	1.25
6379	6320	84	77	117	126	3.5	3.3	35.0	0.32	1.8	1.0	2.25
H 715340	H 715311	88	82	118	132	3.5	3.3	37.1	0.47	1.3	0.70	2.4
395 A	394 A	73	73	101	104	0.8	1.3	20.9	0.40	1.5	0.82	0.528
395 S	394 A	79	73	101	104	3.5	1.3	20.9	0.40	1.5	0.82	0.524
3984	3920	80	74	99	106	3.5	3.2	25.5	0.40	1.5	0.82	0.712
3994	3920	84	74	99	106	5.5	3.2	25.5	0.40	1.5	0.82	0.706
39590	39521	80	74	103	107	3.5	0.8	23.5	0.34	1.8	0.97	0.822
39590	39520	80	74	101	107	3.5	3.3	23.5	0.34	1.8	0.97	0.822
33262	33462	81	75	104	112	3.5	3.3	26.8	0.44	1.4	0.76	0.911
560	553 X	81	75	108	115	3.5	3.3	28.8	0.35	1.7	0.95	1.14
HM 212049	HM 212010	82	75	110	116	3.5	1.5	26.9	0.34	1.8	0.98	1.25
HM 212049	HM 212011	81	74	108	116	3.5	3.3	26.9	0.34	1.8	0.98	1.25
560	552 A	81	75	109	116	3.5	3.3	28.8	0.35	1.7	0.95	1.14
H 715341	H 715311	89	83	118	132	3.5	3.3	37.1	0.47	1.3	0.70	2.34
399 A	394 A	78	74	101	104	2.3	1.3	20.9	0.40	1.5	0.82	0.497
480	472	83	76	106	113	3.5	2	25.1	0.38	1.6	0.86	0.862
560 S	553 X	83	76	108	115	3.5	3.3	28.8	0.35	1.7	0.95	1.09
570	563	83	77	112	120	3.5	3.3	28.3	0.36	1.6	0.91	1.32
H 414245	H 414210	86	82	121	129	3.5	3.3	30.6	0.36	1.7	0.92	1.95
H 715343	H 715311	90	84	118	132	3.5	3.3	37.1	0.47	1.3	0.70	2.28
9185	9121	94	81	130	145	3.5	3.3	44.3	0.66	0.92	0.50	2.53
LM 613449	LM 613410	78	76	104	107	1.5	0.8	22.1	0.42	1.4	0.79	0.562
29675	29620	80	77	101	109	1.5	3.3	26.3	0.49	1.2	0.68	0.695
33275	33462	84	77	104	112	3.5	3.3	26.8	0.44	1.4	0.76	0.83
47487	47420	84	78	107	114	3.5	3.3	26.0	0.36	1.7	0.92	1.02
29675	29630	79	78	105	113	1.5	3.3	26.3	0.49	1.2	0.68	0.695
566	563 X	85	78	114	120	3.5	0.8	28.3	0.36	1.6	0.91	1.27
643	633	86	80	116	124	3.5	3.3	29.9	0.36	1.7	0.91	1.56
H 913849	H 913810	95	82	124	138	3.5	3.3	44.4	0.78	0.77	0.42	1.95
655	653	88	82	131	139	3.5	3.3	33.2	0.41	1.5	0.81	2.35
6454	6420	94	85	129	140	5	3.3	39.0	0.36	1.7	0.91	2.95
745 A	742	88	82	134	142	3.5	3.3	32.5	0.33	1.8	1.0	2.82

Note ▲ The tolerances are listed in Tables 2, 3 and 4 on Pages B113 and B114.

SINGLE-ROW TAPERED ROLLER BEARINGS (INCH DESIGN)

Bore Diameter 70.000 – 76.200 mm

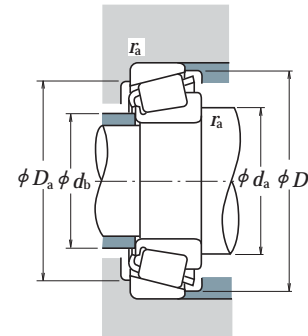
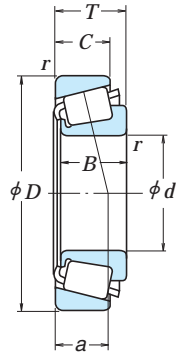

Dynamic Equivalent Load

$$P = XF_r + YF_a$$

$F_a / F_r \leq e$		$F_a / F_r > e$	
X	Y	X	Y
1	0	0.4	Y_1

Static Equivalent Load

$P_0 = 0.5F_r + Y_0F_a$
 When $F_r > 0.5F_r + Y_0F_a$, use $P_0 = F_r$
 The values of e , Y_1 , and Y_0 are given in the table below.

d	Boundary Dimensions (mm)					Cone Cup r min.	Basic Load Ratings (kgf)				Limiting Speeds (min ⁻¹)	
	D	T	B	C	C _r		C _{0r}	C _r	C _{0r}	Grease	Oil	
70.000	110.000	26.000	25.000	20.500	1.0	2.5	98 500	152 000	10 000	15 500	3 000	4 000
	115.000	29.000	29.000	23.000	3.0	2.5	126 000	177 000	12 900	18 100	3 000	4 000
	120.000	29.795	29.007	24.237	2.0	2.0	123 000	169 000	12 500	17 200	3 000	4 000
71.438	117.475	30.162	30.162	23.812	3.5	3.3	119 000	179 000	12 200	18 300	3 000	4 000
	120.000	32.545	32.545	26.195	3.5	3.3	152 000	225 000	15 500	22 900	3 000	4 000
	127.000	36.512	36.170	28.575	6.4	3.3	166 000	234 000	16 900	23 900	2 800	3 800
	127.000	36.512	36.170	28.575	3.5	3.3	166 000	234 000	16 900	23 900	2 800	3 800
	130.175	41.275	41.275	31.750	6.4	3.3	195 000	263 000	19 800	26 800	2 800	3 800
	136.525	41.275	41.275	31.750	3.5	3.3	195 000	263 000	19 800	26 800	2 800	3 800
	136.525	41.275	41.275	31.750	3.5	3.3	229 000	297 000	23 300	30 500	2 600	3 600
	136.525	46.038	46.038	36.512	3.5	3.3	233 000	370 000	23 800	37 500	2 600	3 400
73.025	112.712	25.400	25.400	19.050	3.5	3.3	96 000	152 000	9 800	15 500	2 800	4 000
	117.475	30.162	30.162	23.812	3.5	3.3	119 000	179 000	12 200	18 300	3 000	4 000
	127.000	36.512	36.170	28.575	3.5	3.3	166 000	234 000	16 900	23 900	2 800	3 800
	146.050	41.275	41.275	31.750	3.5	3.3	207 000	296 000	21 100	30 000	2 400	3 200
149.225	53.975	54.229	44.450	3.5	3.3	287 000	410 000	29 300	41 500	2 600	3 400	
73.817	127.000	36.512	36.170	28.575	0.8	3.3	166 000	234 000	16 900	23 900	2 800	3 800
74.612	150.000	41.275	41.275	31.750	3.5	3.0	207 000	296 000	21 100	30 000	2 400	3 200
75.000	115.000	25.000	25.000	19.000	3.0	2.5	101 000	150 000	10 300	15 300	3 000	4 000
	120.000	31.000	29.500	25.000	3.0	2.5	129 000	198 000	13 100	20 200	2 800	3 800
	145.000	51.000	51.000	42.000	3.0	2.5	283 000	410 000	28 900	41 500	2 600	3 400
76.200	121.442	24.608	23.012	17.462	2.0	2.0	89 000	124 000	9 100	12 600	2 800	3 800
	127.000	30.162	31.000	22.225	3.5	3.3	134 000	195 000	13 700	19 900	2 800	3 800
	127.000	30.162	31.001	22.225	6.4	3.3	134 000	195 000	13 700	19 900	2 800	3 800
	133.350	33.338	33.338	26.195	0.8	3.3	154 000	237 000	15 700	24 200	2 600	3 600
	135.733	44.450	46.101	34.925	3.5	3.3	216 000	340 000	22 000	35 000	2 600	3 600
	136.525	30.162	29.769	22.225	3.5	3.3	130 000	192 000	13 300	19 600	2 600	3 400
	136.525	30.162	29.769	22.225	6.4	3.3	130 000	192 000	13 300	19 600	2 600	3 400
	139.992	36.512	36.098	28.575	3.5	3.3	175 000	260 000	17 800	26 500	2 600	3 400
	149.225	53.975	54.229	44.450	3.5	3.3	287 000	410 000	29 300	41 500	2 600	3 400
	152.400	39.688	36.322	30.162	3.5	3.2	183 000	285 000	18 700	29 100	2 200	3 200
	152.400	41.275	41.275	31.750	3.5	3.3	207 000	296 000	21 100	30 000	2 400	3 200
	161.925	49.212	46.038	31.750	3.5	3.3	248 000	290 000	25 300	29 600	2 200	3 000
	161.925	53.975	55.100	42.862	3.5	3.3	325 000	480 000	33 000	49 000	2 200	3 000
	161.925	53.975	55.100	42.862	6.4	3.3	325 000	480 000	33 000	49 000	2 200	3 000
	161.925	53.975	55.100	42.862	6.4	0.8	325 000	480 000	33 000	49 000	2 200	3 000

Bearing Numbers		Abutment and Fillet Dimensions (mm)					Eff. Load Centers (mm) a	Constant e	Axial Load Factors		Mass (kg)		
CONE	CUP	d _a	d _b	D _a	D _b	Cone Cup r _a max.			Y ₁	Y ₀			
▲ JLM 813049	▲ JLM 813010	78	77	98	105	1	2.5	26.2	0.49	1.2	0.68	0.604	0.304
▲ JM 612949	▲ JM 612910	83	77	103	110	3	2.5	26.4	0.43	1.4	0.77	0.800	0.362
484	472	80	78	106	113	2	2	25.1	0.38	1.6	0.86	0.822	0.493
33281	33462	85	79	104	112	3.5	3.3	26.8	0.44	1.4	0.76	0.789	0.442
47490	47420	86	79	107	114	3.5	3.3	26.0	0.36	1.7	0.92	0.983	0.477
567 S	563	92	80	112	120	6.4	3.3	28.3	0.36	1.6	0.91	1.21	0.655
567 A	563	86	80	112	120	3.5	3.3	28.3	0.36	1.6	0.91	1.23	0.655
645	633	93	81	116	124	6.4	3.3	29.9	0.36	1.7	0.91	1.49	0.712
644	632	87	81	118	125	3.5	3.3	29.9	0.36	1.7	0.91	1.5	1.04
H 414249	H 414210	89	83	121	129	3.5	3.3	30.6	0.36	1.7	0.92	1.83	0.796
H 715345	H 715311	92	84	119	132	3.5	3.3	37.1	0.47	1.3	0.70	2.15	0.961
29685	29620	86	80	101	109	3.5	3.3	26.3	0.49	1.2	0.68	0.62	0.273
33287	33462	87	80	104	112	3.5	3.3	26.8	0.44	1.4	0.76	0.746	0.442
567	563	88	81	112	120	3.5	3.3	28.3	0.36	1.6	0.91	1.17	0.655
657	653	91	85	131	139	3.5	3.3	33.2	0.41	1.5	0.81	2.24	0.891
6460	6420	93	87	129	140	3.5	3.3	39.0	0.36	1.7	0.91	2.8	1.63
568	563	83	82	112	120	0.8	3.3	28.3	0.36	1.6	0.91	1.15	0.655
658	653 X	92	86	133	141	3.5	3	33.2	0.41	1.5	0.81	2.37	0.932
▲ JLM 714149	▲ JLM 714110	87	81	104	110	3	2.5	25.3	0.46	1.3	0.72	0.638	0.272
▲ JM 714249	▲ JM 714210	88	83	108	115	3	2.5	28.8	0.44	1.4	0.74	0.863	0.436
▲ JH 415647	▲ JH 415610	94	89	129	139	3	2.5	36.7	0.36	1.7	0.91	2.64	1.19
34300	34478	86	84	111	116	2	2	26.3	0.45	1.3	0.73	0.65	0.316
42687	42620	90	84	114	121	3.5	3.3	27.3	0.42	1.4	0.79	1.03	0.438
42688	42620	94	84	114	121	6.4	3.3	27.3	0.42	1.4	0.79	1.01	0.438
47680	47620	86	85	119	128	0.8	3.3	29.0	0.40	1.5	0.82	1.39	0.577
5760	5735	94	88	119	130	3.5	3.3	32.9	0.41	1.5	0.81	1.86	0.887
495 A	493	92	86	122	130	3.5	3.3	28.7	0.44	1.4	0.74	1.27	0.55
495 AX	493	98	86	122	130	6.4	3.3	28.7	0.44	1.4	0.74	1.26	0.55
575	572	92	86	125	133	3.5	3.3	31.1	0.40	1.5	0.82	1.61	0.788
6461	6420	96	89	129	140	3.5	3.3	39.0	0.36	1.7	0.91	2.64	1.63
590 A	592 A	95	89	135	145	3.5	3.2	37.1	0.44	1.4	0.75	2.2	1.06
659	652	93	87	134	141	3.5	3.3	33.2	0.41	1.5	0.81	2.11	1.26
9285	9220	103	90	138	153	3.5	3.3	49.8	0.71	0.85	0.47	2.82	1.4
6576	6535	99	92	141	154	3.5	3.3	40.7	0.40	1.5	0.82	3.74	1.67
6575	6535	104	92	141	154	6.4	3.3	40.7	0.40	1.5	0.82	3.73	1.67
6575	6536	104	92	144	154	6.4	0.8	40.7	0.40	1.5	0.82	3.73	1.68

Note ▲ The tolerances are listed in Tables 2, 3 and 4 on Pages B113 and B114.

SINGLE-ROW TAPERED ROLLER BEARINGS (INCH DESIGN)

Bore Diameter 76.200 – 83.345 mm

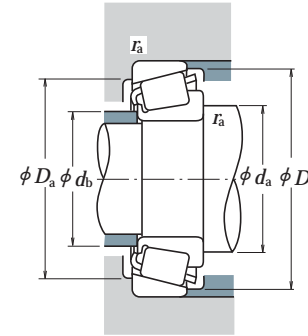
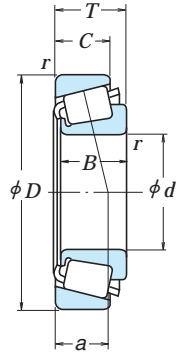

Dynamic Equivalent Load

$$P = XF_r + YF_a$$

$F_a/F_r \leq e$		$F_a/F_r > e$	
X	Y	X	Y
1	0	0.4	Y_1

Static Equivalent Load

$$P_0 = 0.5F_r + Y_0F_a$$

When $F_r > 0.5F_r + Y_0F_a$, use $P_0 = F_r$

The values of e , Y_1 , and Y_0 are given in the table below.

d	Boundary Dimensions (mm)					Cone r min.	Cup r	Basic Load Ratings (kgf)				Limiting Speeds (min ⁻¹)	
	D	T	B	C	C _r			C _{0r}	C _r	C _{0r}	Grease	Oil	
76.200	168.275	53.975	56.363	41.275	6.4	3.3	345 000	470 000	35 000	48 000	2 200	3 000	
	168.275	53.975	56.363	41.275	0.8	3.3	345 000	470 000	35 000	48 000	2 200	3 000	
	171.450	49.212	46.038	31.750	3.5	3.3	257 000	310 000	26 200	32 000	2 000	2 800	
	177.800	55.562	50.800	34.925	3.5	3.3	257 000	310 000	26 200	32 000	2 000	2 800	
77.788	121.442	24.608	23.012	17.462	3.5	2.0	89 000	124 000	9 100	12 600	2 800	3 800	
	127.000	30.162	31.000	22.225	3.5	3.3	134 000	195 000	13 700	19 900	2 800	3 800	
	135.733	44.450	46.101	34.925	3.5	3.3	216 000	340 000	22 000	35 000	2 600	3 600	
	139.992	44.450	46.672	36.512	3.5	3.3	207 000	296 000	21 100	30 000	2 400	3 200	
79.375	146.050	41.275	41.275	31.750	3.5	3.3	207 000	296 000	21 100	30 000	2 400	3 200	
	150.089	44.450	46.672	36.512	3.5	3.3	265 000	370 000	27 000	37 500	2 400	3 200	
80.000	130.000	35.000	34.000	28.500	3.0	2.5	166 000	251 000	17 000	25 600	2 600	3 600	
80.962	136.525	30.162	29.769	22.225	3.5	3.3	130 000	192 000	13 300	19 600	2 600	3 400	
	139.700	36.512	36.098	28.575	3.5	3.3	175 000	260 000	17 800	26 500	2 600	3 400	
	139.992	36.512	36.098	28.575	3.5	3.3	175 000	260 000	17 800	26 500	2 600	3 400	
82.550	125.412	25.400	25.400	19.845	3.5	1.5	102 000	164 000	10 400	16 700	2 600	3 600	
	133.350	30.162	29.769	22.225	3.5	3.3	130 000	192 000	13 300	19 600	2 600	3 400	
	133.350	33.338	33.338	26.195	3.5	3.3	154 000	237 000	15 700	24 200	2 600	3 600	
	133.350	33.338	33.338	26.195	0.8	3.3	154 000	237 000	15 700	24 200	2 600	3 600	
	133.350	33.338	33.338	26.195	6.8	3.3	154 000	237 000	15 700	24 200	2 600	3 600	
	133.350	39.688	39.688	32.545	6.8	3.3	179 000	310 000	18 300	31 500	2 600	3 600	
	136.525	30.162	29.769	22.225	3.5	3.3	130 000	192 000	13 300	19 600	2 600	3 400	
	139.700	36.512	36.098	28.575	3.5	3.3	175 000	260 000	17 800	26 500	2 600	3 400	
	139.992	36.512	36.098	28.575	3.5	3.3	175 000	260 000	17 800	26 500	2 600	3 400	
	139.992	36.512	36.098	28.575	6.8	3.3	175 000	260 000	17 800	26 500	2 600	3 400	
	146.050	41.275	41.275	31.750	3.5	3.3	207 000	296 000	21 100	30 000	2 400	3 200	
	150.000	44.455	46.672	35.000	3.5	3.3	265 000	370 000	27 000	37 500	2 400	3 200	
83.345	150.089	44.450	46.672	36.512	3.5	3.3	265 000	370 000	27 000	37 500	2 400	3 200	
	152.400	41.275	41.275	31.750	3.5	3.3	207 000	296 000	21 100	30 000	2 400	3 200	
	161.925	47.625	48.260	38.100	3.5	3.3	274 000	390 000	28 000	40 000	2 200	3 000	
	161.925	53.975	55.100	42.862	3.5	3.3	325 000	480 000	33 000	49 000	2 200	3 000	
	168.275	47.625	48.260	38.100	3.5	3.3	274 000	390 000	28 000	40 000	2 200	3 000	
	168.275	53.975	56.363	41.275	3.5	3.3	345 000	470 000	35 000	48 000	2 200	3 000	

Bearing Numbers		Abutment and Fillet Dimensions (mm)					Eff. Load Centers (mm) a	Constant e	Axial Load Factors		Mass (kg)	
CONE	CUP	da	db	Da	Db	Cone r max.			Cup r max.	Y ₁	Y ₀	approx. CONE
843	832	101	89	149	155	6.4	3.3	0.30	2.0	1.1	4.11	1.74
837	832	90	89	149	155	0.8	3.3	0.30	2.0	1.1	4.13	1.74
9380	9321	105	98	147	164	3.5	3.3	0.76	0.79	0.43	3.47	1.51
9378	9320	105	98	148	164	3.5	3.3	0.76	0.79	0.43	3.71	2.24
34306	34478	90	84	110	116	3.5	2	0.45	1.3	0.73	0.612	0.316
42690	42620	91	85	114	121	3.5	3.3	0.42	1.4	0.79	0.976	0.438
5795	5735	96	89	119	130	3.5	3.3	0.41	1.5	0.81	1.79	0.887
661	653	96	90	131	139	3.5	3.3	0.41	1.5	0.81	1.99	0.891
750	742	96	90	134	142	3.5	3.3	0.33	1.8	1.0	2.42	1.07
▲ JM 515649	▲ JM 515610	94	88	117	125	3	2.5	0.39	1.5	0.85	1.18	0.583
496	493	95	89	122	130	3.5	3.3	0.44	1.4	0.74	1.13	0.55
581	572 X	96	90	125	133	3.5	3.3	0.40	1.5	0.82	1.44	0.774
581	572	96	90	125	133	3.5	3.3	0.40	1.5	0.82	1.44	0.788
27687	27620	96	89	115	120	3.5	1.5	0.42	1.4	0.79	0.747	0.348
495	492 A	97	90	120	128	3.5	3.3	0.44	1.4	0.74	1.08	0.434
47686	47620	97	90	119	128	3.5	3.3	0.40	1.5	0.82	1.18	0.577
47685	47620	90	90	119	128	0.8	3.3	0.40	1.5	0.82	1.18	0.577
47687	47620	103	90	119	128	6.8	3.3	0.40	1.5	0.82	1.16	0.577
HM 516448	HM 516410	105	92	118	128	6.8	3.3	0.40	1.5	0.82	1.35	0.767
495	493	97	90	122	130	3.5	3.3	0.44	1.4	0.74	1.08	0.55
580	572 X	98	91	125	133	3.5	3.3	0.40	1.5	0.82	1.39	0.774
580	572	98	91	125	133	3.5	3.3	0.40	1.5	0.82	1.39	0.788
582	572	104	91	125	133	6.8	3.3	0.40	1.5	0.82	1.37	0.788
663	653	99	92	131	139	3.5	3.3	0.41	1.5	0.81	1.85	0.891
749 A	743	99	93	134	142	3.5	3.3	0.33	1.8	1.0	2.26	1.04
749 A	742	98	93	135	143	3.5	3.3	0.33	1.8	1.0	2.26	1.07
663	652	99	92	134	141	3.5	3.3	0.41	1.5	0.81	1.85	1.26
757	752	100	94	144	150	3.5	3.3	0.34	1.8	0.97	2.79	1.61
6559	6535	104	98	141	154	3.5	3.3	0.40	1.5	0.82	3.4	1.67
757	753	100	94	147	150	3.5	3.3	0.34	1.8	0.97	2.79	2.1
842	832	101	94	149	155	3.5	3.3	0.30	2.0	1.1	3.76	1.74
27690	27620	96	90	115	120	3.5	1.5	0.42	1.4	0.79	0.727	0.348
27689	27620	90	90	115	120	0.8	1.5	0.42	1.4	0.79	0.732	0.348

Note ▲ The tolerances are listed in Tables 2, 3 and 4 on Pages B113 and B114.

SINGLE-ROW TAPERED ROLLER BEARINGS (INCH DESIGN)

Bore Diameter 84.138 – 90.488 mm

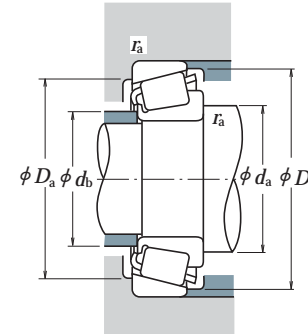
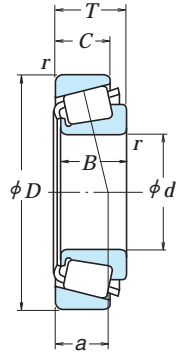

Dynamic Equivalent Load

$$P = XF_r + YF_a$$

$F_a/F_r \leq e$		$F_a/F_r > e$	
X	Y	X	Y
1	0	0.4	Y_1

Static Equivalent Load

$$P_0 = 0.5F_r + Y_0F_a$$

When $F_r > 0.5F_r + Y_0F_a$, use $P_0 = F_r$

The values of e , Y_1 , and Y_0 are given in the table below.

Boundary Dimensions (mm)						Basic Load Ratings (kgf)				Limiting Speeds (min ⁻¹)	
d	D	T	B	C	Cone Cup r min.	C_r	C_{0r}	C_r	C_{0r}	Grease	Oil
84.138	136.525	30.162	29.769	22.225	3.5 3.3	130 000	192 000	13 300	19 600	2 600	3 400
	146.050	41.275	41.275	31.750	3.5 3.3	207 000	296 000	21 100	30 000	2 400	3 200
	171.450	49.212	46.038	31.750	3.5 3.3	257 000	310 000	26 200	32 000	2 000	2 800
85.000	130.000	30.000	29.000	24.000	6.0 2.5	138 000	222 000	14 100	22 700	2 600	3 600
	130.000	30.000	29.000	24.000	3.0 2.5	138 000	222 000	14 100	22 700	2 600	3 600
	140.000	39.000	38.000	31.500	3.0 2.5	202 000	305 000	20 600	31 000	2 400	3 400
	150.000	46.000	46.000	38.000	3.0 2.5	275 000	390 000	28 000	40 000	2 400	3 200
85.026	150.089	44.450	46.672	36.512	3.5 3.3	265 000	370 000	27 000	37 500	2 400	3 200
	150.089	44.450	46.672	36.512	5.0 3.3	265 000	370 000	27 000	37 500	2 400	3 200
85.725	133.350	30.162	29.769	22.225	3.5 3.3	130 000	192 000	13 300	19 600	2 600	3 400
	136.525	30.162	29.769	22.225	3.5 3.3	130 000	192 000	13 300	19 600	2 600	3 400
	142.138	42.862	42.862	34.133	4.8 3.3	221 000	360 000	22 500	36 500	2 400	3 400
85.026	146.050	41.275	41.275	31.750	6.4 3.3	207 000	296 000	21 100	30 000	2 400	3 200
	146.050	41.275	41.275	31.750	3.5 3.3	207 000	296 000	21 100	30 000	2 400	3 200
	152.400	39.688	36.322	30.162	3.5 3.2	183 000	285 000	18 700	29 100	2 200	3 200
	161.925	47.625	48.260	38.100	3.5 3.3	274 000	390 000	28 000	40 000	2 200	3 000
85.026	168.275	41.275	41.275	30.162	3.5 3.3	223 000	345 000	22 700	35 000	2 000	2 800
	168.275	41.275	41.275	30.162	3.5 3.3	223 000	345 000	22 700	35 000	2 000	2 800
87.312	190.500	57.150	57.531	46.038	8.0 3.3	390 000	520 000	39 500	53 500	1 900	2 600
88.900	149.225	31.750	28.971	24.608	3.0 3.3	140 000	218 000	14 300	22 300	2 200	3 000
	152.400	39.688	36.322	30.162	3.5 3.2	183 000	285 000	18 700	29 100	2 200	3 200
	152.400	39.688	39.688	30.162	6.4 3.3	253 000	365 000	25 800	37 500	2 200	3 200
88.900	161.925	47.625	48.260	38.100	3.5 3.3	274 000	390 000	28 000	40 000	2 200	3 000
	161.925	47.625	48.260	38.100	7.0 3.3	274 000	390 000	28 000	40 000	2 200	3 000
	161.925	53.975	55.100	42.862	3.5 3.3	325 000	480 000	33 000	49 000	2 200	3 000
	168.275	47.625	48.260	38.100	3.5 3.3	274 000	390 000	28 000	40 000	2 200	3 000
88.900	168.275	53.975	56.363	41.275	3.5 3.3	345 000	470 000	35 000	48 000	2 200	3 000
	168.275	53.975	56.363	41.275	3.5 3.3	345 000	470 000	35 000	48 000	2 200	3 000
88.900	190.500	57.150	57.531	44.450	8.0 3.3	355 000	500 000	36 000	51 000	1 900	2 600
	190.500	57.150	57.531	46.038	8.0 3.3	390 000	520 000	39 500	53 500	1 900	2 600
90.000	145.000	35.000	34.000	27.000	3.0 2.5	190 000	285 000	19 400	29 000	2 400	3 200
	147.000	40.000	40.000	32.500	7.0 3.5	229 000	345 000	23 400	35 000	2 400	3 200
	155.000	44.000	44.000	35.500	3.0 2.5	274 000	395 000	28 000	40 000	2 200	3 000
90.488	161.925	47.625	48.260	38.100	3.5 3.3	274 000	390 000	28 000	40 000	2 200	3 000

Bearing Numbers		Abutment and Fillet Dimensions (mm)					Eff. Load Centers (mm)	Constant	Axial Load Factors		Mass (kg)
CONE	CUP	d_a	d_b	D_a	D_b	Cone Cup r_a max.	a	e	Y_1	Y_0	approx. CONE CUP
498	493	98	91	122	130	3.5 3.3	28.7	0.44	1.4	0.74	1.04 0.55
664	653	99	93	131	139	3.5 3.3	33.2	0.41	1.5	0.81	1.79 0.891
9385	9321	111	98	147	164	3.5 3.3	54.1	0.76	0.79	0.43	3.11 1.51
▲ JM 716648	▲ JM 716610	104	92	117	125	6 2.5	29.5	0.44	1.4	0.74	0.931 0.461
▲ JM 716649	▲ JM 716610	98	92	117	125	3 2.5	29.5	0.44	1.4	0.74	0.943 0.461
▲ JHM 516849	▲ JHM 516810	100	94	125	134	3 2.5	33.3	0.41	1.5	0.81	1.55 0.768
▲ JH 217249	▲ JH 217210	101	95	134	142	3 2.5	33.9	0.33	1.8	0.99	2.29 1.09
749	742	101	95	134	142	3.5 3.3	32.5	0.33	1.8	1.0	2.14 1.07
749 S	742	104	95	134	142	5 3.3	32.5	0.33	1.8	1.0	2.14 1.07
497	492 A	99	93	120	128	3.5 3.3	28.7	0.44	1.4	0.74	0.987 0.434
497	493	99	93	122	130	3.5 3.3	28.7	0.44	1.4	0.74	0.987 0.55
HM 617049	HM 617010	106	95	125	137	4.8 3.3	35.4	0.43	1.4	0.76	1.77 0.911
665 A	653	107	95	131	139	6.4 3.3	33.2	0.41	1.5	0.81	1.71 0.891
665	653	102	95	131	139	3.5 3.3	33.2	0.41	1.5	0.81	1.72 0.891
596	592 A	102	96	135	144	3.5 3.2	37.1	0.44	1.4	0.75	1.85 1.06
758	752	103	97	144	150	3.5 3.3	35.6	0.34	1.8	0.97	2.63 1.61
677	672	105	99	149	160	3.5 3.3	38.3	0.47	1.3	0.70	2.91 1.24
HH 221432	HH 221410	118	103	171	179	8 3.3	42.3	0.33	1.8	0.99	5.51 2.24
42350	42587	104	98	134	143	3 3.3	34.9	0.49	1.2	0.67	1.39 0.711
593	592 A	104	98	135	144	3.5 3.2	37.1	0.44	1.4	0.75	1.73 1.06
HM 518445	HM 518410	107	96	137	148	6.4 3.3	33.1	0.40	1.5	0.82	2.11 1.076
759	752	106	99	144	150	3.5 3.3	35.6	0.34	1.8	0.97	2.47 1.61
766	752	113	99	144	150	7 3.3	35.6	0.34	1.8	0.97	2.45 1.61
6580	6535	109	102	141	154	3.5 3.3	40.7	0.40	1.5	0.82	3.03 1.67
759	753	106	99	147	150	3.5 3.3	35.6	0.34	1.8	0.97	2.47 2.1
850	832	106	100	149	155	3.5 3.3	35.2	0.30	2.0	1.1	3.39 1.74
855	854	118	103	170	174	8 3.3	41.8	0.33	1.8	0.99	4.99 2.55
HH 221434	HH 221410	120	105	171	179	8 3.3	42.3	0.33	1.8	0.99	5.41 2.24
▲ JM 718149	▲ JM 718110	105	99	131	139	3 2.5	33.0	0.44	1.4	0.74	1.49 0.66
*HM 218248	**HM 218210	111	98	133	141	7 3.5	30.8	0.33	1.8	0.99	1.77 0.796
▲ JHM 318448	▲ JHM 318410	106	100	140	148	3 2.5	34.1	0.34	1.7	0.96	2.32 1.01
760	752	107	101	144	150	3.5 3.3	35.6	0.34	1.8	0.97	2.38 1.61

- Notes
- * The maximum bore diameter is listed and its tolerance is negative (See Table 8.4.1 on Page A68).
 - ** The maximum outside diameter is listed and its tolerance is negative (See Table 8.4.2 on Pages A68 and A69).
 - ▲ The tolerances are listed in Tables 2, 3 and 4 on Pages B113 and B114.

SINGLE-ROW TAPERED ROLLER BEARINGS (INCH DESIGN)

Bore Diameter 92.075 – 100.012 mm

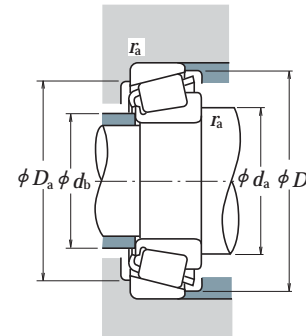
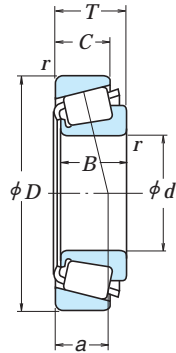

Dynamic Equivalent Load

$$P = XF_r + YF_a$$

$F_a / F_r \leq e$		$F_a / F_r > e$	
X	Y	X	Y
1	0	0.4	Y_1

Static Equivalent Load

$$P_0 = 0.5F_r + Y_0F_a$$

When $F_r > 0.5F_r + Y_0F_a$, use $P_0 = F_r$

The values of e , Y_1 , and Y_0 are given in the table below.

d	Boundary Dimensions (mm)					Cone r min.	Cup r	Basic Load Ratings (N) (kgf)				Limiting Speeds (min ⁻¹)	
	D	T	B	C	C _r			C _{0r}	C _r	C _{0r}	Grease	Oil	
92.075	146.050	33.338	34.925	26.195	3.5	3.3	169 000	280 000	17 300	28 500	2 400	3 200	
	148.430	28.575	28.971	21.433	3.5	3.0	140 000	218 000	14 300	22 300	2 200	3 000	
	152.400	39.688	36.322	30.162	3.5	3.2	183 000	285 000	18 700	29 100	2 200	3 200	
93.662	152.400	39.688	36.322	30.162	6.4	3.2	183 000	285 000	18 700	29 100	2 200	3 200	
	168.275	41.275	41.275	30.162	3.5	3.3	223 000	345 000	22 700	35 000	2 000	2 800	
	190.500	57.150	57.531	44.450	8.0	3.3	355 000	500 000	36 000	51 000	1 900	2 600	
95.000	148.430	28.575	28.971	21.433	3.0	3.0	140 000	218 000	14 300	22 300	2 200	3 000	
	149.225	31.750	28.971	24.608	3.0	3.3	140 000	218 000	14 300	22 300	2 200	3 000	
	152.400	39.688	36.322	30.162	3.5	3.2	183 000	285 000	18 700	29 100	2 200	3 200	
95.250	150.000	35.000	34.000	27.000	3.0	2.5	183 000	285 000	18 700	29 100	2 200	3 200	
	146.050	33.338	34.925	26.195	3.5	3.3	169 000	280 000	17 300	28 500	2 400	3 200	
	148.430	28.575	28.971	21.433	3.0	3.0	140 000	218 000	14 300	22 300	2 200	3 000	
96.838	149.225	31.750	28.971	24.608	3.5	3.3	140 000	218 000	14 300	22 300	2 200	3 000	
	152.400	39.688	36.322	30.162	3.5	3.2	183 000	285 000	18 700	29 100	2 200	3 200	
	152.400	39.688	36.322	33.338	3.5	3.3	183 000	285 000	18 700	29 100	2 200	3 200	
98.425	168.275	41.275	41.275	30.162	3.5	3.3	223 000	345 000	22 700	35 000	2 000	2 800	
	171.450	47.625	48.260	38.100	3.5	3.3	282 000	415 000	28 800	42 500	2 000	2 800	
	180.975	47.625	48.006	38.100	3.5	3.3	258 000	375 000	26 300	38 500	2 000	2 600	
99.982	190.500	57.150	57.531	44.450	8.0	3.3	355 000	500 000	36 000	51 000	1 900	2 600	
	190.500	57.150	57.531	46.038	8.0	3.3	390 000	520 000	39 500	53 500	1 900	2 600	
	190.500	57.150	57.531	46.038	3.5	3.3	355 000	500 000	36 000	51 000	1 900	2 600	
100.012	150.000	32.000	30.000	26.000	2.3	2.3	146 000	235 000	14 900	24 000	2 200	3 000	
	155.000	36.000	35.000	28.000	3.0	2.5	191 000	325 000	19 500	33 000	2 000	2 800	
	160.000	41.000	40.000	32.000	3.0	2.5	239 000	380 000	24 400	38 500	2 000	2 800	

Bearing Numbers		Abutment and Fillet Dimensions (mm)					Eff. Load Centers (mm) a	Constant e	Axial Load Factors		Mass (kg)	
CONE	CUP	d _a	d _b	D _a	D _b	Cone r _a max.			Y ₁	Y ₀	approx. CONE	CUP
47890	47820	107	101	131	140	3.5	3.3	0.45	1.3	0.74	1.46	0.664
42362	42584	107	101	134	142	3.5	3	0.49	1.2	0.67	1.29	0.553
598	592 A	107	101	135	144	3.5	3.2	0.44	1.4	0.75	1.6	1.06
598 A	592 A	113	101	135	144	6.4	3.2	0.44	1.4	0.75	1.59	1.06
681	672	110	104	149	160	3.5	3.3	0.47	1.3	0.70	2.62	1.24
857	854	121	106	170	174	8	3.3	0.33	1.8	0.99	4.78	2.55
42368	42584	107	102	134	142	3	3	0.49	1.2	0.67	1.24	0.553
42368	42587	107	102	134	143	3	3.3	0.49	1.2	0.67	1.24	0.711
597	592 A	109	102	135	144	3.5	3.2	0.44	1.4	0.75	1.54	1.06
▲ JM 719149	▲ JM 719113	109	104	135	143	3	2.5	0.44	1.4	0.75	1.46	0.765
47896	47820	110	103	131	140	3.5	3.3	0.45	1.3	0.74	1.33	0.664
42375	42584	108	103	134	142	3	3	0.49	1.2	0.67	1.18	0.553
42376	42587	109	103	134	143	3.5	3.3	0.49	1.2	0.67	1.18	0.711
594	592 A	110	104	135	144	3.5	3.2	0.44	1.4	0.75	1.47	1.06
594	592	109	103	135	145	3.5	3.3	0.44	1.4	0.75	1.47	1.12
683	672	113	106	149	160	3.5	3.3	0.47	1.3	0.70	2.47	1.24
77375	77675	117	105	152	159	3.5	3.3	0.37	1.6	0.90	2.91	1.67
776	772	114	107	161	168	3.5	3.3	0.39	1.6	0.86	3.25	1.99
864	854	123	108	170	174	8	3.3	0.33	1.8	0.99	4.57	2.55
HH 221440	HH 221410	125	110	171	179	8	3.3	0.33	1.8	0.99	5.0	2.24
42381	42584	110	104	134	142	3.5	3	0.49	1.2	0.67	1.13	0.553
42381	42587	111	105	135	143	3.5	3.3	0.49	1.2	0.67	1.13	0.711
52387	52637	114	108	144	154	3.5	3.3	0.47	1.3	0.69	1.89	0.942
685	672	116	109	149	160	3.5	3.3	0.47	1.3	0.70	2.32	1.24
779	772	116	110	161	168	3.5	3.3	0.39	1.6	0.86	3.06	1.99
866	854	118	111	170	174	3.5	3.3	0.33	1.8	0.99	4.38	2.55
HH 221442	HH 221410	119	113	171	179	3.5	3.3	0.33	1.8	0.99	4.81	2.24
HH 221447	HH 221410	126	114	171	179	6.4	3.3	0.33	1.8	0.99	4.68	2.24
▲ JLM 820048	▲ JLM 820012	111	107	135	144	2.3	2.3	0.50	1.2	0.66	1.27	0.616
▲ JM 720249	▲ JM 720210	115	109	140	149	3	2.5	0.47	1.3	0.70	1.68	0.772
▲ JHM 720249	▲ JHM 720210	117	109	143	154	3	2.5	0.47	1.3	0.70	2.09	0.974
52393	52618	116	109	142	152	3.5	3.3	0.47	1.3	0.69	1.81	0.702

Note ▲ The tolerances are listed in Tables 2, 3 and 4 on Pages B113 and B114.

Bore Diameter 101.600 – 117.475 mm

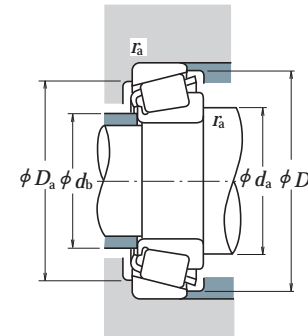
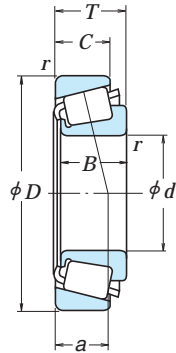

Dynamic Equivalent Load

$$P = XF_r + YF_a$$

$F_a / F_r \leq e$		$F_a / F_r > e$	
X	Y	X	Y
1	0	0.4	Y_1

Static Equivalent Load

$$P_0 = 0.5F_r + Y_0F_a$$

When $F_r > 0.5F_r + Y_0F_a$, use $P_0 = F_r$

The values of e , Y_1 , and Y_0 are given in the table below.

d	Boundary Dimensions (mm)					Cone r min.	Cup r	Basic Load Ratings (N) (kgf)				Limiting Speeds (min ⁻¹)	
	D	T	B	C	C _r			C _{0r}	C _r	C _{0r}	Grease	Oil	
101.600	157.162	36.512	36.116	26.195	3.5	3.3	191 000	310 000	19 500	31 500	2 000	2 800	
	161.925	36.512	36.116	26.195	3.5	3.3	191 000	310 000	19 500	31 500	2 000	2 800	
	168.275	41.275	41.275	30.162	3.5	3.3	223 000	345 000	22 700	35 000	2 000	2 800	
180.975	47.625	48.006	38.100	3.5	3.3	258 000	375 000	26 300	38 500	2 000	2 600		
	190.500	57.150	57.531	44.450	8.0	3.3	355 000	500 000	36 000	51 000	1 900	2 600	
	190.500	57.150	57.531	46.038	8.0	3.3	390 000	520 000	39 500	53 500	1 900	2 600	
	212.725	66.675	66.675	53.975	7.0	3.3	570 000	810 000	58 000	82 500	1 700	2 200	
104.775	180.975	47.625	48.006	38.100	7.0	3.3	258 000	375 000	26 300	38 500	2 000	2 600	
	180.975	47.625	48.006	38.100	3.5	3.3	258 000	375 000	26 300	38 500	2 000	2 600	
	190.500	47.625	49.212	34.925	3.5	3.3	296 000	465 000	30 000	47 000	1 800	2 400	
106.362	165.100	36.512	36.512	26.988	3.5	3.3	195 000	320 000	19 800	33 000	2 000	2 600	
107.950	158.750	23.020	21.438	15.875	3.5	3.3	102 000	165 000	10 400	16 800	2 000	2 800	
	159.987	34.925	34.925	26.988	3.5	3.3	164 000	315 000	16 700	32 000	2 000	2 800	
	161.925	34.925	34.925	26.988	3.5	3.3	164 000	280 000	16 800	28 600	2 000	2 800	
	165.100	36.512	36.512	26.988	3.5	3.3	195 000	320 000	19 800	33 000	2 000	2 600	
109.987	190.500	47.625	49.212	34.925	3.5	3.3	296 000	465 000	30 000	47 000	1 800	2 400	
	212.725	66.675	66.675	53.975	8.0	3.3	570 000	810 000	58 000	82 500	1 700	2 200	
	159.987	34.925	34.925	26.988	3.5	3.3	164 000	315 000	16 700	32 000	2 000	2 800	
109.992	159.987	34.925	34.925	26.988	8.0	3.3	164 000	315 000	16 700	32 000	2 000	2 800	
	177.800	41.275	41.275	30.162	3.5	3.3	232 000	375 000	23 700	38 000	1 800	2 600	
110.000	165.000	35.000	35.000	26.500	3.0	2.5	195 000	320 000	19 800	33 000	2 000	2 600	
	180.000	47.000	46.000	38.000	3.0	2.5	310 000	490 000	31 500	50 000	1 900	2 600	
111.125	190.500	47.625	49.212	34.925	3.5	3.3	296 000	465 000	30 000	47 000	1 800	2 400	
114.300	152.400	21.433	21.433	16.670	1.5	1.5	89 500	178 000	9 100	18 100	2 000	2 800	
	177.800	41.275	41.275	30.162	3.5	3.3	232 000	375 000	23 700	38 000	1 800	2 600	
	180.000	34.925	31.750	25.400	3.5	0.8	174 000	254 000	17 800	25 900	1 800	2 400	
	190.500	47.625	49.212	34.925	3.5	3.3	296 000	465 000	30 000	47 000	1 800	2 400	
	212.725	66.675	66.675	53.975	7.0	3.3	475 000	700 000	48 500	71 500	1 700	2 400	
	212.725	66.675	66.675	53.975	7.0	3.3	570 000	810 000	58 000	82 500	1 700	2 200	
115.087	190.500	47.625	49.212	34.925	3.5	3.3	296 000	465 000	30 000	47 000	1 800	2 400	
117.475	180.975	34.925	31.750	25.400	3.5	3.3	174 000	254 000	17 800	25 900	1 800	2 400	

Bearing Numbers		Abutment and Fillet Dimensions (mm)					Cone r _a max.	Cup r _a max.	Eff. Load Centers (mm) a	Constant e	Axial Load Factors		Mass (kg)	
CONE	CUP	d _a	d _b	D _a	D _b	Y ₁					Y ₀	approx. CONE	CUP	
52400	52618	117	111	142	152	3.5	3.3	36.1	0.47	1.3	0.69	1.75	0.702	
52400	52637	117	111	144	154	3.5	3.3	36.1	0.47	1.3	0.69	1.75	0.942	
687	672	118	112	149	160	3.5	3.3	38.3	0.47	1.3	0.70	2.15	1.24	
780	772	119	113	161	168	3.5	3.3	39.1	0.39	1.6	0.86	2.88	1.99	
861	854	129	114	170	174	8	3.3	41.8	0.33	1.8	0.99	4.13	2.55	
HH 221449	HH 221410	131	116	171	179	8	3.3	42.3	0.33	1.8	0.99	4.55	2.24	
HH 224335	HH 224310	132	121	192	202	7	3.3	47.3	0.33	1.8	1.0	8.14	3.06	
787	772	129	116	161	168	7	3.3	39.1	0.39	1.6	0.86	2.66	1.99	
782	772	122	116	161	168	3.5	3.3	39.1	0.39	1.6	0.86	2.68	1.99	
71412	71750	124	118	171	181	3.5	3.3	40.1	0.42	1.4	0.79	4.0	1.71	
56418	56650	122	116	149	159	3.5	3.3	38.6	0.50	1.2	0.66	1.87	0.861	
37425	37625	122	115	143	152	3.5	3.3	37.0	0.61	0.99	0.54	0.886	0.488	
LM 522546	LM 522510	122	116	146	154	3.5	3.3	33.7	0.40	1.5	0.82	1.65	0.784	
48190	48120	122	116	146	156	3.5	3.3	38.7	0.51	1.2	0.65	1.59	0.83	
56425	56650	123	117	149	159	3.5	3.3	38.6	0.50	1.2	0.66	1.8	0.861	
71425	71750	126	120	171	181	3.5	3.3	40.1	0.42	1.4	0.79	3.79	1.71	
HH 224340	HH 224310	139	126	192	202	8	3.3	47.3	0.33	1.8	1.0	7.58	3.06	
LM 522549	LM 522510	124	118	146	154	3.5	3.3	33.7	0.40	1.5	0.82	1.55	0.784	
LM 522548	LM 522510	133	118	146	154	8	3.3	33.7	0.40	1.5	0.82	1.53	0.784	
64433	64700	128	121	160	172	3.5	3.3	42.4	0.52	1.2	0.64	2.64	1.11	
▲ JM 822049	▲ JM 822010	124	119	149	159	3	2.5	38.3	0.50	1.2	0.66	1.64	0.842	
▲ JHM 522649	▲ JHM 522610	127	122	162	172	3	2.5	40.9	0.41	1.5	0.81	3.12	1.51	
71437	71750	129	123	171	181	3.5	3.3	40.1	0.42	1.4	0.79	3.58	1.71	
L 623149	L 623110	123	121	143	148	1.5	1.5	27.4	0.41	1.5	0.80	0.725	0.344	
64450	64700	131	125	160	172	3.5	3.3	42.4	0.52	1.2	0.64	2.39	1.11	
68450	** 68709	130	123	165	172	3.5	0.8	40.0	0.50	1.2	0.66	1.95	1.0	
71450	71750	132	125	171	181	3.5	3.3	40.1	0.42	1.4	0.79	3.37	1.71	
938	932	141	128	187	193	7	3.3	46.9	0.33	1.8	1.0	6.01	4.11	
HH 224346	HH 224310	143	131	192	202	7	3.3	47.3	0.33	1.8	1.0	7.01	3.06	
71453	71750	133	126	171	181	3.5	3.3	40.1	0.42	1.4	0.79	3.31	1.71	
68462	68712	132	125	163	172	3.5	3.3	40.0	0.50	1.2	0.66	1.73	1.05	

Notes ** The maximum outside diameter is listed and its tolerance is negative (See Table 8.4.2 on Pages A68 and A69).

▲ The tolerances are listed in Tables 2, 3 and 4 on Pages B113 and B114.

Bore Diameter 120.000 – 165.100 mm

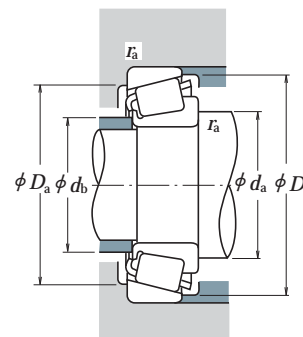
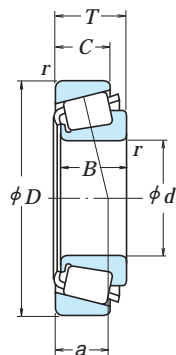

Dynamic Equivalent Load

$$P = XF_r + YF_a$$

$F_a / F_r \leq e$		$F_a / F_r > e$	
X	Y	X	Y
1	0	0.4	Y_1

Static Equivalent Load

$$P_0 = 0.5F_r + Y_0F_a$$

When $F_r > 0.5F_r + Y_0F_a$, use $P_0 = F_r$

The values of e , Y_1 , and Y_0 are given in the table below.

Boundary Dimensions (mm)					Cone		Basic Load Ratings (N)				Limiting Speeds (min ⁻¹)	
d	D	T	B	C	r_{min}	Cup	C_r	C_{0r}	C_r	C_{0r}	Grease	Oil
120.000	170.000	25.400	25.400	19.050	3.3	3.3	130 000	219 000	13 200	22 300	1 900	2 600
	174.625	35.720	36.512	27.783	3.5	1.5	212 000	385 000	21 600	39 000	1 900	2 600
120.650	182.562	39.688	38.100	33.338	3.5	3.3	228 000	445 000	23 200	45 000	1 800	2 400
	206.375	47.625	47.625	34.925	3.3	3.3	320 000	530 000	32 500	54 000	1 600	2 200
123.825	182.562	39.688	38.100	33.338	3.5	3.3	228 000	445 000	23 200	45 000	1 800	2 400
	125.000	175.000	25.400	25.400	18.288	3.3	3.3	134 000	232 000	13 700	23 600	1 800
127.000	165.895	18.258	17.462	13.495	1.5	1.5	84 500	149 000	8 650	15 200	1 900	2 600
	182.562	39.688	38.100	33.338	3.5	3.3	228 000	445 000	23 200	45 000	1 800	2 400
	196.850	46.038	46.038	38.100	3.5	3.3	315 000	560 000	32 000	57 500	1 700	2 200
	215.900	47.625	47.625	34.925	3.5	3.3	287 000	495 000	29 300	50 000	1 500	2 000
128.588	206.375	47.625	47.625	34.925	3.3	3.3	320 000	530 000	32 500	54 000	1 600	2 200
	130.000	206.375	47.625	47.625	3.5	3.3	320 000	530 000	32 500	54 000	1 600	2 200
130.175	203.200	46.038	46.038	38.100	3.5	3.3	315 000	560 000	32 000	57 500	1 700	2 200
	206.375	47.625	47.625	34.925	3.5	3.3	320 000	530 000	32 500	54 000	1 600	2 200
133.350	177.008	25.400	26.195	20.638	1.5	1.5	124 000	258 000	12 700	26 300	1 800	2 400
	190.500	39.688	39.688	33.338	3.5	3.3	240 000	485 000	24 500	49 500	1 700	2 200
	196.850	46.038	46.038	38.100	3.5	3.3	315 000	560 000	32 000	57 500	1 700	2 200
	215.900	47.625	47.625	34.925	3.5	3.3	287 000	495 000	29 300	50 000	1 500	2 000
136.525	190.500	39.688	39.688	33.338	3.5	3.3	216 000	440 000	22 000	45 000	1 700	2 200
	217.488	47.625	47.625	34.925	3.5	3.3	287 000	495 000	29 300	50 000	1 500	2 000
139.700	187.325	28.575	29.370	23.020	1.5	1.5	153 000	305 000	15 600	31 500	1 700	2 200
	215.900	47.625	47.625	34.925	3.5	3.3	287 000	495 000	29 300	50 000	1 500	2 000
	254.000	66.675	66.675	47.625	7.0	3.3	515 000	830 000	52 500	84 500	1 300	1 800
142.875	200.025	41.275	39.688	34.130	3.5	3.3	227 000	460 000	23 100	46 500	1 600	2 200
146.050	193.675	28.575	28.575	23.020	1.5	1.5	170 000	355 000	17 300	36 500	1 600	2 200
	236.538	57.150	56.642	44.450	3.5	3.3	455 000	720 000	46 000	73 500	1 400	1 900
	254.000	66.675	66.675	47.625	7.0	3.3	515 000	830 000	52 500	84 500	1 300	1 800
149.225	254.000	66.675	66.675	47.625	7.0	3.3	515 000	830 000	52 500	84 500	1 300	1 800
	152.400	254.000	66.675	66.675	47.625	7.0	3.3	515 000	830 000	52 500	84 500	1 300
158.750	225.425	41.275	39.688	33.338	3.5	3.3	240 000	540 000	24 400	55 000	1 400	1 900
	165.100	247.650	47.625	47.625	38.100	3.5	3.3	345 000	705 000	35 500	71 500	1 300

Bearing Numbers		Abutment and Fillet Dimensions (mm)					Eff. Load Centers (mm)	Constant	Axial Load Factors		Mass (kg)	
CONE	CUP	d_a	d_b	D_a	D_b	Cone r_a max.	a	e	Y_1	Y_0	approx. CONE	CUP
▲ JL 724348	▲ JL 724314	132	127	156	163	3.3	32.9	0.46	1.3	0.72	1.08	0.591
	* M 224748	135	129	163	168	3.5	32.2	0.33	1.8	0.99	1.9	0.866
48282	48220	136	133	168	176	3.5	34.2	0.31	2.0	1.1	2.56	1.14
	795	139	134	186	198	3.3	45.7	0.46	1.3	0.72	4.44	1.9
48286	48220	139	133	168	176	3.5	34.2	0.31	2.0	1.1	2.37	1.14
	▲ JL 725346	138	133	161	168	3.3	34.3	0.48	1.3	0.69	1.19	0.573
LL 225749	LL 225710	135	132	158	160	1.5	24.2	0.33	1.8	0.99	0.647	0.288
	48290	141	135	168	176	3.5	34.2	0.31	2.0	1.1	2.19	1.14
	67388	144	138	180	189	3.5	39.7	0.34	1.7	0.96	3.74	1.46
	74500	148	141	196	208	3.5	48.4	0.49	1.2	0.68	4.92	1.99
799	792	146	140	186	198	3.3	45.7	0.46	1.3	0.72	3.86	1.9
	797	148	141	186	198	3.5	45.7	0.46	1.3	0.72	3.76	1.9
67389	67320	146	141	183	191	3.5	39.7	0.34	1.7	0.96	3.51	2.06
	799 A	148	142	186	198	3.5	45.7	0.46	1.3	0.72	3.74	1.9
L 327249	L 327210	143	141	167	171	1.5	29.5	0.35	1.7	0.95	1.18	0.55
	48385	148	142	177	184	3.5	35.9	0.32	1.9	1.0	2.58	1.16
	67390	149	143	180	189	3.5	39.7	0.34	1.7	0.96	3.27	1.46
	74525	152	146	196	208	3.5	48.4	0.49	1.2	0.68	4.44	1.99
48393	48320	151	144	177	184	3.5	35.9	0.32	1.9	1.0	2.31	1.16
	74537	155	148	197	210	3.5	48.4	0.49	1.2	0.68	4.19	2.13
LM 328448	LM 328410	149	147	176	182	1.5	31.7	0.36	1.7	0.93	1.59	0.67
	74550	158	151	196	208	3.5	48.4	0.49	1.2	0.68	3.93	1.99
	99550	170	156	227	238	7	55.3	0.41	1.5	0.81	9.99	3.83
48685	48620	158	151	185	193	3.5	37.6	0.34	1.8	0.98	2.63	1.19
	36690	155	154	182	188	1.5	33.5	0.37	1.6	0.90	1.64	0.725
HM 231140	HM 231110	164	160	217	224	3.5	45.9	0.32	1.9	1.0	6.07	2.93
	99575	175	162	227	238	7	55.3	0.41	1.5	0.81	9.24	3.83
99587	99100	178	165	227	238	7	55.3	0.41	1.5	0.81	8.86	3.83
	99600	181	167	227	238	7	55.3	0.41	1.5	0.81	8.46	3.83
46780	46720	176	169	209	218	3.5	44.3	0.38	1.6	0.86	3.69	1.66
	67780	185	179	229	240	3.5	52.4	0.44	1.4	0.75	5.83	2.33

Notes * The maximum bore diameter is listed and its tolerance is negative (See Table 8.4.1 on Page A68).

▲ The tolerances are listed in Tables 2, 3 and 4 on Pages B113 and B114.

SINGLE-ROW TAPERED ROLLER BEARINGS (INCH DESIGN)

Bore Diameter 170.000 – 206.375 mm

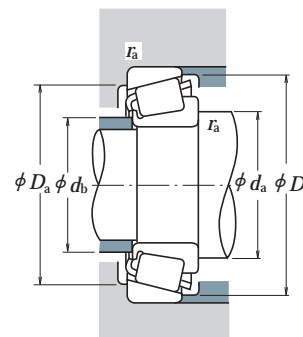
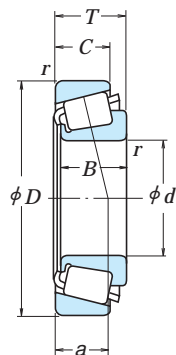

Dynamic Equivalent Load

$$P = XF_r + YF_a$$

$F_a/F_r \leq e$		$F_a/F_r > e$	
X	Y	X	Y
1	0	0.4	Y_1

Static Equivalent Load

$$P_0 = 0.5F_r + Y_0F_a$$

When $F_r > 0.5F_r + Y_0F_a$, use $P_0 = F_r$

The values of e , Y_1 , and Y_0 are given in the table below.

	Boundary Dimensions (mm)					Cone $r_{min.}$	Cup $r_{max.}$	Basic Load Ratings (N)				Limiting Speeds (min^{-1})	
	d	D	T	B	C			C_r	C_{0r}	C_r	C_{0r}	Grease	Oil
170.000	230.000	39.000	38.000	31.000	3.0	2.5	278 000	520 000	28 300	53 000	1 300	1 800	
	240.000	46.000	44.500	37.000	3.0	2.5	380 000	720 000	39 000	73 000	1 300	1 800	
174.625	247.650	47.625	47.625	38.100	3.5	3.3	345 000	705 000	35 500	71 500	1 300	1 700	
177.800	227.012	30.162	30.162	23.020	1.5	1.5	181 000	415 000	18 500	42 000	1 300	1 800	
	247.650	47.625	47.625	38.100	3.5	3.3	345 000	705 000	35 500	71 500	1 300	1 700	
	260.350	53.975	53.975	41.275	3.5	3.3	455 000	835 000	46 500	85 000	1 200	1 700	
190.000	260.000	46.000	44.000	36.500	3.0	2.5	370 000	730 000	38 000	74 500	1 100	1 600	
	266.700	47.625	46.833	38.100	3.5	3.3	345 000	720 000	35 000	73 000	1 100	1 500	
200.000	300.000	65.000	62.000	51.000	3.5	2.5	615 000	1 130 000	62 500	116 000	1 000	1 400	
203.200	282.575	46.038	46.038	36.512	3.5	3.3	365 000	800 000	37 500	81 500	1 000	1 400	
206.375	282.575	46.038	46.038	36.512	3.5	3.3	365 000	800 000	37 500	81 500	1 000	1 400	

Bearing Numbers		Abutment and Fillet Dimensions (mm)					Eff. Load Centers (mm) a	Constant e	Axial Load Factors		Mass (kg)		
CONE	CUP	d_a	d_b	D_a	D_b	Cone $r_{a,max.}$			Cup $r_{a,max.}$	Y_1	Y_0	approx. CONE	CUP
▲ JHM 534149	▲ JHM 534110	184	178	217	224	3	2.5	43.2	0.38	1.6	0.86	3.1	1.3
▲ JM 734449	▲ JM 734410	185	180	222	232	3	2.5	50.5	0.44	1.4	0.75	4.42	2.02
67787	67720	192	185	229	240	3.5	3.3	52.4	0.44	1.4	0.75	4.88	2.33
36990	36920	189	186	214	221	1.5	1.5	42.9	0.44	1.4	0.75	2.1	0.907
67790	67720	194	188	229	240	3.5	3.3	52.4	0.44	1.4	0.75	4.56	2.33
M 236849	M 236810	195	192	241	249	3.5	3.3	47.5	0.33	1.8	0.99	6.49	2.86
▲ JM 738249	▲ JM 738210	206	200	242	252	3	2.5	56.4	0.48	1.3	0.69	4.73	2.2
67885	67820	209	203	246	259	3.5	3.3	57.9	0.48	1.3	0.69	5.4	2.64
▲ JHM 840449	▲ JHM 840410	223	215	273	289	3.5	2.5	73.1	0.52	1.2	0.63	10.3	5.19
67983	67920	222	216	260	275	3.5	3.3	61.9	0.51	1.2	0.65	6.03	2.82
67985	67920	224	219	260	275	3.5	3.3	61.9	0.51	1.2	0.65	5.66	2.82

Note ▲ The tolerances are listed in Tables 2, 3 and 4 on Pages B113 and B114.

Bore Diameter 40 – 90 mm

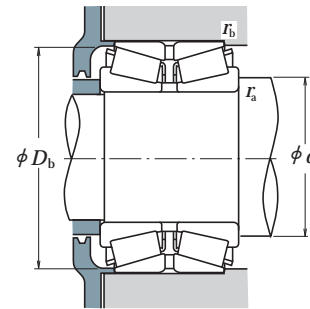
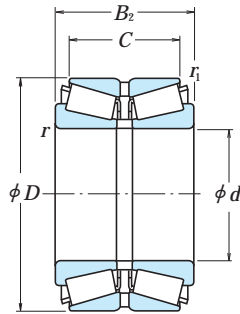

Dynamic Equivalent Load

$$P = XF_r + YF_a$$

$F_a/F_r \leq e$		$F_a/F_r > e$	
X	Y	X	Y
1	Y_3	0.67	Y_2

Static Equivalent Load

$$P_0 = F_r + Y_0 F_a$$

The values of e , Y_2 , Y_3 , and Y_0 are given in the table below.

d	Boundary Dimensions (mm)					Basic Load Ratings (N)		Limiting Speeds (min ⁻¹)	
	D	B ₂	C	r min.	r ₁ min.	C _r	C _{0r}	Grease	Oil
40	80	45	37.5	1.5	0.6	109 000	140 000	3 700	5 100
	85	55	43.5	1.5	0.6	117 000	159 000	3 400	4 700
50	90	48	38.5	1.5	0.6	131 000	183 000	3 200	4 400
	90	49	39.5	1.5	0.6	131 000	183 000	3 200	4 400
	90	55	43.5	1.5	0.6	150 000	218 000	3 200	4 400
	110	64	51.5	2.5	0.6	224 000	297 000	2 700	3 700
55	100	51	41.5	2	0.6	162 000	226 000	2 900	3 900
	100	52	42.5	2	0.6	162 000	226 000	2 900	3 900
	100	60	48.5	2	0.6	188 000	274 000	2 900	3 900
	120	70	57	2.5	0.6	256 000	342 000	2 500	3 400
60	110	53	43.5	2	0.6	178 000	246 000	2 700	3 600
	110	66	54.5	2	0.6	225 000	335 000	2 700	3 600
	130	74	59	3	1	298 000	405 000	2 300	3 200
65	120	56	46.5	2	0.6	210 000	300 000	2 400	3 200
	120	57	47.5	2	0.6	210 000	300 000	2 400	3 200
	120	73	61.5	2	0.6	269 000	405 000	2 400	3 300
	140	79	63	3	1	340 000	465 000	2 100	2 900
70	125	57	46.5	2	0.6	227 000	325 000	2 300	3 100
	125	59	48.5	2	0.6	227 000	325 000	2 300	3 100
	125	74	61.5	2	0.6	270 000	410 000	2 300	3 100
	150	83	67	3	1	390 000	535 000	2 000	2 700
75	130	62	51.5	2	0.6	245 000	365 000	2 200	3 000
	130	74	61.5	2	0.6	283 000	440 000	2 200	3 000
	160	87	69	3	1	435 000	600 000	1 900	2 500
80	140	61	49	2.5	0.6	269 000	390 000	2 000	2 800
	140	64	51.5	2.5	0.6	269 000	390 000	2 000	2 800
	140	78	63.5	2.5	0.6	330 000	505 000	2 000	2 800
	170	92	73	3	1	475 000	655 000	1 700	2 400
85	150	70	57	2.5	0.6	315 000	465 000	1 900	2 600
	150	86	69	2.5	0.6	360 000	555 000	1 900	2 600
	180	98	77	4	1	530 000	745 000	1 600	2 200
90	160	71	58	2.5	0.6	345 000	510 000	1 800	2 400
	160	74	61	2.5	0.6	345 000	510 000	1 800	2 400
	160	94	77	2.5	0.6	440 000	700 000	1 800	2 400

Bearing Numbers	Abutment and Fillet Dimensions (mm)				Constant e	Axial Load Factors			Mass (kg) approx.
	d _a min.	D _b min.	r _a max.	r _b max.		Y ₂	Y ₃	Y ₀	
HR 40 KBE 42+L	51	75	1.5	0.6	0.37	2.7	1.8	1.8	0.97
HR 45 KBE 42+L	56	81	1.5	0.6	0.40	2.5	1.7	1.6	1.08
HR 45 KBE 52X+L	56	81	1.5	0.6	0.40	2.5	1.7	1.6	1.31
HR 50 KBE 042+L	61	87	1.5	0.6	0.42	2.4	1.6	1.6	1.20
HR 50 KBE 42+L	61	87	1.5	0.6	0.42	2.4	1.6	1.6	1.22
HR 50 KBE 52X+L	61	87	1.5	0.6	0.42	2.4	1.6	1.6	1.39
HR 50 KBE 043+L	65	104	2	0.6	0.35	2.9	2.0	1.9	2.77
HR 55 KBE 042+L	67	96	2	0.6	0.40	2.5	1.7	1.6	1.59
HR 55 KBE 1003+L	67	96	2	0.6	0.40	2.5	1.7	1.6	1.63
HR 55 KBE 52X+L	67	97	2	0.6	0.40	2.5	1.7	1.6	1.88
HR 55 KBE 43+L	70	113	2	0.6	0.35	2.9	2.0	1.9	3.52
HR 60 KBE 042+L	72	105	2	0.6	0.40	2.5	1.7	1.6	2.03
HR 60 KBE 52X+L	72	106	2	0.6	0.40	2.5	1.7	1.6	2.52
HR 60 KBE 43+L	78	122	2.5	1	0.35	2.9	2.0	1.9	4.40
HR 65 KBE 42+L	77	115	2	0.6	0.40	2.5	1.7	1.6	2.58
HR 65 KBE 1202+L	77	115	2	0.6	0.40	2.5	1.7	1.6	2.61
HR 65 KBE 52X+L	77	117	2	0.6	0.40	2.5	1.7	1.6	3.35
HR 65 KBE 43+L	83	132	2.5	1	0.35	2.9	2.0	1.9	5.42
HR 70 KBE 042+L	82	120	2	0.6	0.42	2.4	1.6	1.6	2.79
HR 70 KBE 42+L	82	120	2	0.6	0.42	2.4	1.6	1.6	2.85
HR 70 KBE 52X+L	82	121	2	0.6	0.42	2.4	1.6	1.6	3.58
HR 70 KBE 43+L	88	142	2.5	1	0.35	2.9	2.0	1.9	6.45
HR 75 KBE 42+L	87	126	2	0.6	0.44	2.3	1.6	1.5	3.15
HR 75 KBE 52X+L	87	127	2	0.6	0.44	2.3	1.6	1.5	3.73
HR 75 KBE 043+L	93	151	2.5	1	0.35	2.9	2.0	1.9	7.66
HR 80 KBE 042+L	95	134	2	0.6	0.42	2.4	1.6	1.6	3.70
HR 80 KBE 42+L	95	134	2	0.6	0.42	2.4	1.6	1.6	3.70
HR 80 KBE 52X+L	95	136	2	0.6	0.42	2.4	1.6	1.6	4.59
HR 80 KBE 043+L	98	161	2.5	1	0.35	2.9	2.0	1.9	9.02
HR 85 KBE 42+L	100	143	2	0.6	0.42	2.4	1.6	1.6	4.69
HR 85 KBE 52X+L	100	144	2	0.6	0.42	2.4	1.6	1.6	5.70
HR 85 KBE 043+L	106	169	3	1	0.35	2.9	2.0	1.9	10.8
HR 90 KBE 042+L	105	152	2	0.6	0.42	2.4	1.6	1.6	5.53
HR 90 KBE 42+L	105	152	2	0.6	0.42	2.4	1.6	1.6	5.71
HR 90 KBE 52X+L	105	154	2	0.6	0.42	2.4	1.6	1.6	7.26

Remarks For other double-row tapered roller bearings not listed above, please contact NSK.

Bore Diameter 90 – 120 mm

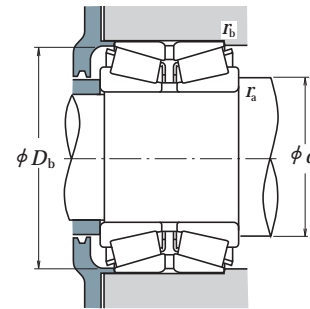
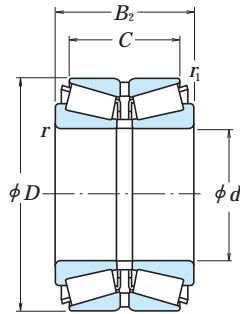

Dynamic Equivalent Load

$$P = XF_r + YF_a$$

$F_a/F_r \leq e$		$F_a/F_r > e$	
X	Y	X	Y
1	Y_3	0.67	Y_2

Static Equivalent Load

$$P_0 = F_r + Y_0 F_a$$

The values of e , Y_2 , Y_3 , and Y_0 are given in the table below.

d	Boundary Dimensions (mm)					Basic Load Ratings (N)		Limiting Speeds (min ⁻¹)		
	D	B ₂	C	r min.	r ₁ min.	C _r	C _{0r}	Grease	Oil	
90	190	102	81	4	1	595 000	845 000	1 600	2 100	
	190	144	115	4	1	770 000	1 180 000	1 600	2 200	
95	170	78	63	3	1	385 000	570 000	1 700	2 300	
	170	100	83	3	1	495 000	800 000	1 700	2 300	
	200	108	85	4	1	640 000	910 000	1 500	2 000	
100	165	52	46	2.5	0.6	222 000	340 000	1 700	2 300	
	180	81	64	3	1	435 000	665 000	1 600	2 200	
	180	81	65	3	1	435 000	665 000	1 600	2 200	
	180	82	66	3	1	435 000	665 000	1 600	2 200	
	180	83	67	3	1	435 000	665 000	1 600	2 200	
	180	105	85	3	1	555 000	905 000	1 600	2 200	
	180	107	87	3	1	555 000	905 000	1 600	2 200	
	180	110	90	3	1	555 000	905 000	1 600	2 200	
	215	112	87	4	1	725 000	1 050 000	1 400	1 900	
	105	190	88	70	3	1	480 000	735 000	1 500	2 000
190		117	96	3	1	620 000	1 020 000	1 500	2 000	
190		115	95	3	1	620 000	1 020 000	1 500	2 000	
225		116	91	4	1	780 000	1 130 000	1 300	1 800	
180		56	50	2.5	0.6	264 000	400 000	1 500	2 000	
110	180	70	56	2.5	0.6	340 000	555 000	1 500	2 000	
	180	125	100	2.5	0.6	550 000	1 060 000	1 500	2 100	
	200	90	72	3	1	540 000	840 000	1 400	1 900	
	200	92	74	3	1	540 000	840 000	1 400	1 900	
	200	120	100	3	1	685 000	1 130 000	1 400	1 900	
	200	121	101	3	1	685 000	1 130 000	1 400	1 900	
	240	118	93	4	1.5	830 000	1 190 000	1 200	1 700	
	120	180	46	41	2.5	0.6	184 000	296 000	1 500	2 000
		180	58	46	2.5	0.6	260 000	450 000	1 500	2 000
		200	62	55	2.5	0.6	310 000	500 000	1 400	1 800
200		78	62	2.5	0.6	415 000	690 000	1 400	1 900	
200		100	84	2.5	0.6	515 000	885 000	1 400	1 800	
215		97	78	3	1	575 000	900 000	1 300	1 800	
215		132	109	3	1	750 000	1 270 000	1 300	1 800	
260		128	101	4	1	915 000	1 310 000	1 100	1 500	
260		188	145	4	1	1 320 000	2 110 000	1 100	1 500	

Bearing Numbers	Abutment and Fillet Dimensions (mm)				Constant e	Axial Load Factors			Mass (kg) approx.
	d _a min.	D _b min.	r _a max.	r _b max.		Y ₂	Y ₃	Y ₀	
HR 90 KBE 043+L	111	178	3	1	0.35	2.9	2.0	1.9	12.7
HR 90 KBE 1901+L	111	179	3	1	0.35	2.9	2.0	1.9	17.9
HR 95 KBE 42+L	113	161	2.5	1	0.42	2.4	1.6	1.6	6.75
HR 95 KBE 52+L	113	163	2.5	1	0.42	2.4	1.6	1.6	8.60
HR 95 KBE 43+L	116	187	3	1	0.35	2.9	2.0	1.9	14.7
100 KBE 31+L	115	156	2	0.6	0.33	3.0	2.0	2.0	4.04
HR100 KBE 1805+L	118	170	2.5	1	0.42	2.4	1.6	1.6	8.16
HR100 KBE 042+L	118	170	2.5	1	0.42	2.4	1.6	1.6	8.13
HR100 KBE 1801+L	118	170	2.5	1	0.42	2.4	1.6	1.6	8.22
HR100 KBE 42+L	118	170	2.5	1	0.42	2.4	1.6	1.6	8.7
HR100 KBE 1802+L	118	173	2.5	1	0.42	2.4	1.6	1.6	10.6
HR100 KBE 52X+L	118	173	2.5	1	0.42	2.4	1.6	1.6	10.7
HR100 KBE 1804+L	118	173	2.5	1	0.42	2.4	1.6	1.6	11
HR100 KBE 043+L	121	200	3	1	0.35	2.9	2.0	1.9	18.1
HR105 KBE 42X+L	123	179	2.5	1	0.42	2.4	1.6	1.6	9.76
HR105 KBE 1902+L	123	182	2.5	1	0.42	2.4	1.6	1.6	13.4
HR105 KBE 52+L	123	182	2.5	1	0.42	2.4	1.6	1.6	13.1
HR105 KBE 043+L	126	209	3	1	0.35	2.9	2.0	1.9	20.4
110 KBE 31+L	125	172	2	0.6	0.39	2.6	1.7	1.7	5.11
110 KBE 031+L	125	172	2	0.6	0.39	2.6	1.7	1.7	6.33
110 KBE 1802+L	125	172	2	0.6	0.26	3.8	2.6	2.5	11.4
HR110 KBE 42+L	128	190	2.5	1	0.42	2.4	1.6	1.6	11.2
HR110 KBE 42X+L	128	190	2.5	1	0.42	2.4	1.6	1.6	11.5
HR110 KBE 2001+L	128	193	2.5	1	0.42	2.4	1.6	1.6	15.4
HR110 KBE 52X+L	128	193	2.5	1	0.42	2.4	1.6	1.6	15.2
HR110 KBE 043+L	131	223	3	1.5	0.35	2.9	2.0	1.9	23.6
120 KBE 30+L	135	172	2	0.6	0.40	2.5	1.7	1.6	3.75
120 KBE 030+L	135	172	2	0.6	0.39	2.6	1.7	1.7	4.64
120 KBE 31+L	135	190	2	0.6	0.39	2.6	1.7	1.7	7.35
120 KBE 031+L	135	190	2	0.6	0.39	2.6	1.7	1.7	8.97
120 KBE 2001+L	135	193	2	0.6	0.37	2.7	1.8	1.8	11.3
HR120 KBE 42X+L	138	204	2.5	1	0.44	2.3	1.6	1.5	13.7
HR120 KBE 52X+L	138	207	2.5	1	0.44	2.3	1.6	1.5	18.8
HR120 KBE 43+L	141	240	3	1	0.35	2.9	2.0	1.9	29.4
HR120 KBE 2601+L	141	242	3	1	0.35	2.9	2.0	1.9	44.6

Remarks For other double-row tapered roller bearings not listed above, please contact NSK.

Bore Diameter 125 – 150 mm

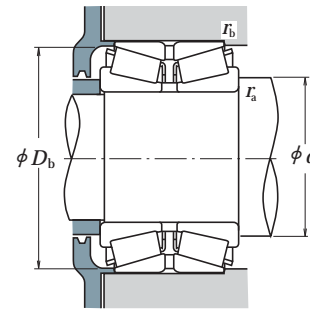
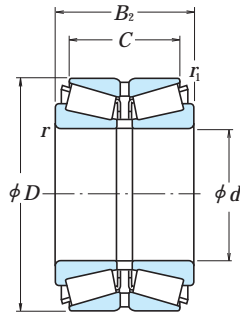

Dynamic Equivalent Load

$$P = XF_r + YF_a$$

$F_a/F_r \leq e$		$F_a/F_r > e$	
X	Y	X	Y
1	Y_3	0.67	Y_2

Static Equivalent Load

$$P_0 = F_r + Y_0 F_a$$

The values of e , Y_2 , Y_3 , and Y_0 are given in the table below.

d	Boundary Dimensions (mm)					Basic Load Ratings (N)		Limiting Speeds (min ⁻¹)	
	D	B ₂	C	r _{min.}	r _{1 min.}	C _r	C _{0r}	Grease	Oil
125	210	110	88	4	1	560 000	1 030 000	1 300	1 800
130	230	98	78.5	4	1	640 000	1 010 000	1 200	1 600
	230	100	80.5	4	1	640 000	1 010 000	1 200	1 600
	280	137	107.5	5	1.5	940 000	1 350 000	1 000	1 400
140	230	145	115	4	1	905 000	1 580 000	1 200	1 700
	230	145	117.5	4	1	905 000	1 580 000	1 200	1 700
	230	150	120	4	1	905 000	1 580 000	1 200	1 700
150	210	53	47	2.5	0.6	280 000	495 000	1 200	1 700
	210	66	53	2.5	1	305 000	530 000	1 200	1 700
	210	106	94	2.5	0.6	555 000	1 200 000	1 300	1 700
	225	68	61	3	1	400 000	630 000	1 200	1 600
	225	84	68	3	1	490 000	850 000	1 200	1 600
	225	85	68	3	1	490 000	850 000	1 200	1 600
	230	120	94	3	1	685 000	1 270 000	1 200	1 600
	230	140	110	3	1	820 000	1 550 000	1 200	1 600
	240	132	106	4	1.5	685 000	1 360 000	1 100	1 500
	250	102	82.5	4	1	670 000	1 030 000	1 100	1 500
	250	153	125.5	4	1	1 040 000	1 830 000	1 100	1 500
	300	145	115.5	5	1.5	1 030 000	1 480 000	1 000	1 300
150	225	56	50	3	1	300 000	545 000	1 200	1 600
	225	70	56	3	1	395 000	685 000	1 200	1 600
	250	80	71	3	1	510 000	810 000	1 100	1 400
	250	100	80	3	1	630 000	1 090 000	1 100	1 400
	250	115	95	3	1	745 000	1 320 000	1 100	1 500
	260	150	115	4	1	815 000	1 520 000	1 100	1 400
	270	109	87	4	1	830 000	1 330 000	1 000	1 400
	270	164	130	4	1	1 210 000	2 150 000	1 000	1 400
	270	174	140	4	1	1 210 000	2 150 000	1 000	1 400
	320	154	120	5	1.5	1 420 000	2 130 000	900	1 200

Remarks For other double-row tapered roller bearings not listed above, please contact NSK.

Bearing Numbers	Abutment and Fillet Dimensions (mm)				Constant e	Axial Load Factors			Mass (kg) approx.
	d _{a min.}	D _{b min.}	r _{a max.}	r _{b max.}		Y ₂	Y ₃	Y ₀	
125 KBE 2101+L	146	201	3	1	0.43	2.3	1.6	1.5	14.5
HR130 KBE 42+L	151	220	3	1	0.44	2.3	1.6	1.5	15.8
HR130 KBE 2301+L	151	220	3	1	0.44	2.3	1.6	1.5	15.9
130 KBE 43+L	157	258	4	1.5	0.36	2.8	1.9	1.8	35
HR130 KBE 2302+L	151	221	3	1	0.44	2.3	1.6	1.5	24.1
HR130 KBE 52+L	151	222	3	1	0.44	2.3	1.6	1.5	23.8
HR130 KBE 2303+L	151	221	3	1	0.44	2.3	1.6	1.5	24.2
140 KBE 30+L	155	202	2	0.6	0.39	2.6	1.7	1.7	6.02
140 KBE 030+L	155	202	2	1	0.40	2.5	1.7	1.6	7.02
140 KBE 2101+L	155	202	2	0.6	0.33	3.0	2.0	2.0	12.3
140 KBE 31+L	158	216	2.5	1	0.39	2.6	1.7	1.7	9.31
140 KBE 031+L	158	215	2.5	1	0.39	2.6	1.7	1.7	11.6
140 KBE 2201+L	158	215	2.5	1	0.39	2.6	1.7	1.7	11.7
140 KBE 2301+L	158	220	2.5	1	0.33	3.0	2.0	2.0	17.6
140 KBE 2302+L	158	221	2.5	1	0.35	2.9	2.0	1.9	20.7
140 KBE 2401+L	161	227	3	1.5	0.44	2.3	1.5	1.5	22.7
HR140 KBE 42+L	161	237	3	1	0.44	2.3	1.6	1.5	18.9
HR140 KBE 52X+L	161	241	3	1	0.44	2.3	1.6	1.5	29.6
140 KBE 43+L	167	275	4	1.5	0.36	2.8	1.9	1.8	42.6
150 KBE 30+L	168	213	2.5	1	0.35	2.9	2.0	1.9	7.41
150 KBE 030+L	168	215	2.5	1	0.35	2.9	2.0	1.9	8.70
150 KBE 31+L	168	240	2.5	1	0.40	2.5	1.7	1.6	14.2
150 KBE 031+L	168	238	2.5	1	0.39	2.6	1.7	1.7	17.8
150 KBE 2502+L	168	238	2.5	1	0.37	2.7	1.8	1.8	20.9
150 KBE 2601+L	171	242	3	1	0.43	2.3	1.6	1.5	30.0
HR150 KBE 42+L	171	253	3	1	0.44	2.3	1.6	1.5	24.3
HR150 KBE 52X+L	171	257	3	1	0.44	2.3	1.6	1.5	37.3
HR150 KBE 2701+L	171	257	3	1	0.44	2.3	1.6	1.5	39.7
HR150 KBE 43+L	177	295	4	1.5	0.35	2.9	2.0	1.9	53.4

Bore Diameter 160 – 200 mm

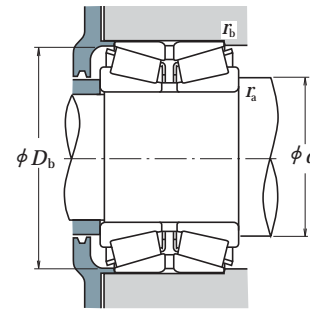
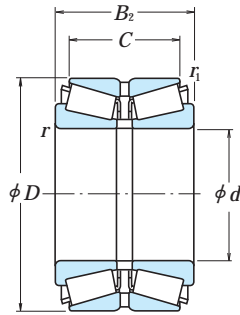

Dynamic Equivalent Load

$$P = XF_r + YF_a$$

$F_a/F_r \leq e$		$F_a/F_r > e$	
X	Y	X	Y
1	Y_3	0.67	Y_2

Static Equivalent Load

$$P_0 = F_r + Y_0 F_a$$

The values of e , Y_2 , Y_3 , and Y_0 are given in the table below.

d	Boundary Dimensions (mm)					Basic Load Ratings (N)		Limiting Speeds (min ⁻¹)		
	D	B ₂	C	r min.	r ₁ min.	C _r	C _{0r}	Grease	Oil	
160	240	60	53	3	1	355 000	580 000	1 100	1 500	
	240	75	60	3	1	395 000	710 000	1 100	1 500	
	240	110	90	3	1	650 000	1 290 000	1 100	1 500	
	270	86	76	3	1	540 000	885 000	1 000	1 300	
	270	108	86	3	1	775 000	1 380 000	1 000	1 300	
	270	140	120	3	1	990 000	1 880 000	1 000	1 300	
	280	150	125	4	1	1 100 000	2 020 000	1 000	1 300	
	290	115	91	4	1	800 000	1 220 000	900	1 300	
165	290	178	144	4	1	1 360 000	2 440 000	1 000	1 300	
	340	160	126	5	1.5	1 310 000	1 920 000	800	1 100	
	290	150	125	4	1	1 140 000	2 130 000	900	1 300	
	170	250	85	65	3	1	435 000	845 000	1 000	1 400
		260	67	60	3	1	400 000	700 000	1 000	1 300
		260	84	67	3	1	575 000	1 030 000	1 000	1 300
		280	88	78	3	1	630 000	1 040 000	900	1 300
	280	110	88	3	1	820 000	1 450 000	900	1 300	
280	150	130	3	1	1 110 000	2 160 000	1 000	1 300		
310	192	152	5	1.5	1 590 000	2 910 000	900	1 200		
180	280	74	66	3	1	455 000	810 000	900	1 300	
	280	93	74	3	1	655 000	1 220 000	900	1 200	
	300	96	85	4	1.5	725 000	1 210 000	900	1 200	
	300	120	96	4	1.5	940 000	1 690 000	900	1 200	
	320	127	99	5	1.5	895 000	1 390 000	800	1 200	
	320	192	152	5	1.5	1 640 000	3 050 000	900	1 200	
	340	180	140	5	1.5	1 410 000	2 510 000	800	1 100	
	190	290	75	67	3	1	490 000	845 000	900	1 200
290		94	75	3	1	670 000	1 230 000	900	1 200	
320		104	92	4	1.5	800 000	1 380 000	800	1 100	
320		130	104	4	1.5	1 070 000	1 960 000	800	1 100	
340		133	105	5	1.5	990 000	1 580 000	800	1 100	
340		204	160	5	1.5	1 910 000	3 550 000	800	1 100	
200	310	152	123	3	1	1 300 000	2 740 000	800	1 100	
	320	146	110	5	1.5	990 000	2 120 000	800	1 100	
	330	180	140	5	1.5	1 390 000	2 730 000	800	1 100	
	340	112	100	4	1.5	940 000	1 670 000	800	1 000	
	340	140	112	4	1.5	1 260 000	2 250 000	800	1 000	
	360	142	110	5	1.5	1 100 000	1 780 000	700	1 000	
	360	218	174	5	1.5	2 070 000	3 850 000	800	1 000	

Bearing Numbers	Abutment and Fillet Dimensions (mm)				Constant e	Axial Load Factors			Mass (kg) approx.
	d _a min.	D _b min.	r _a max.	r _b max.		Y ₂	Y ₃	Y ₀	
160 KBE 30+L	178	231	2.5	1	0.37	2.7	1.8	1.8	8.56
160 KBE 030+L	178	230	2.5	1	0.40	2.5	1.7	1.6	10.5
160 KBE 2401+L	178	232	2.5	1	0.38	2.6	1.8	1.7	16.2
160 KBE 31+L	178	255	2.5	1	0.40	2.5	1.7	1.6	18.6
160 KBE 031+L	178	256	2.5	1	0.39	2.6	1.7	1.7	23.1
160 KBE 2701+L	178	261	2.5	1	0.39	2.6	1.7	1.7	30.6
160 KBE 2801+L	181	266	3	1	0.32	3.2	2.1	2.1	35.9
160 KBE 42+L	181	275	3	1	0.43	2.3	1.6	1.5	28.2
HR160 KBE 52X+L	181	277	3	1	0.44	2.3	1.6	1.5	47.3
160 KBE 43+L	187	314	4	1.5	0.36	2.8	1.9	1.8	60.4
165 KBE 2901+L	186	272	3	1	0.33	3.1	2.1	2.0	39.5
170 KBE 2501+L	188	241	2.5	1	0.44	2.3	1.5	1.5	12.3
170 KBE 30+L	188	248	2.5	1	0.40	2.5	1.7	1.6	11.8
170 KBE 030+L	188	249	2.5	1	0.39	2.6	1.7	1.7	14.4
170 KBE 31+L	188	266	2.5	1	0.39	2.6	1.7	1.7	19.7
170 KBE 031+L	188	268	2.5	1	0.39	2.6	1.7	1.7	24.2
170 KBE 2802+L	188	269	2.5	1	0.39	2.6	1.7	1.7	34.6
HR170 KBE 52X+L	197	297	4	1.5	0.44	2.3	1.6	1.5	57.3
180 KBE 30+L	198	265	2.5	1	0.40	2.5	1.7	1.6	15.4
180 KBE 030+L	198	265	2.5	1	0.35	2.9	2.0	1.9	14.4
180 KBE 31+L	201	284	3	1.5	0.39	2.6	1.7	1.7	24.8
180 KBE 031+L	201	287	3	1.5	0.39	2.6	1.7	1.7	31.1
180 KBE 42+L	207	300	4	1.5	0.44	2.3	1.5	1.5	36.5
HR180 KBE 52X+L	207	308	4	1.5	0.45	2.2	1.5	1.5	59.2
180 KBE 3401+L	207	305	4	1.5	0.43	2.3	1.6	1.5	68.1
190 KBE 30+L	208	279	2.5	1	0.39	2.6	1.7	1.7	16.2
190 KBE 030+L	208	279	2.5	1	0.40	2.5	1.7	1.6	20.1
190 KBE 31+L	211	301	3	1.5	0.40	2.5	1.7	1.6	30.9
190 KBE 031+L	211	302	3	1.5	0.39	2.6	1.7	1.7	39.0
190 KBE 42+L	217	320	4	1.5	0.40	2.5	1.7	1.6	43.9
HR190 KBE 52X+L	217	327	4	1.5	0.44	2.3	1.6	1.5	70.8
HR200 KBE 3101+L	218	301	2.5	1	0.43	2.3	1.6	1.5	40.1
200 KBE 3201+L	227	301	4	1.5	0.52	1.9	1.3	1.3	41.6
200 KBE 3301+L	227	316	4	1.5	0.42	2.4	1.6	1.6	54.4
200 KBE 31+L	221	321	3	1.5	0.40	2.5	1.7	1.6	38.8
200 KBE 031+L	221	324	3	1.5	0.39	2.6	1.7	1.7	47.0
200 KBE 42+L	227	338	4	1.5	0.40	2.5	1.7	1.6	52.6
HR200 KBE 52+L	227	344	4	1.5	0.41	2.5	1.7	1.6	88.3

Remarks For other double-row tapered roller bearings not listed above, please contact NSK.

Bore Diameter 206 – 260 mm

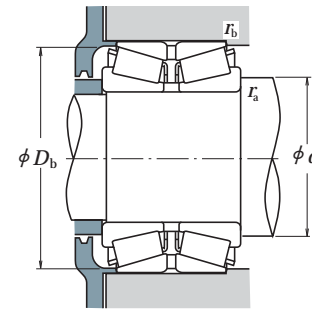
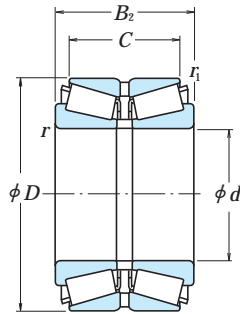

Dynamic Equivalent Load

$$P = XF_r + YF_a$$

$F_a / F_r \leq e$		$F_a / F_r > e$	
X	Y	X	Y
1	Y_3	0.67	Y_2

Static Equivalent Load

$$P_0 = F_r + Y_0 F_a$$

The values of e , Y_2 , Y_3 , and Y_0 are given in the table below.

d	Boundary Dimensions (mm)					Basic Load Ratings (N)		Limiting Speeds (min ⁻¹)	
	D	B ₂	C	r _{min.}	r _{1 min.}	C _r	C _{0r}	Grease	Oil
206	283	102	83	4	1.5	580 000	1 430 000	900	1 200
210	355	116	103	4	1.5	905 000	1 520 000	700	1 000
220	300	110	88	3	1	730 000	1 710 000	800	1 100
	340	90	80	4	1.5	695 000	1 280 000	700	1 000
	340	113	90	4	1.5	920 000	1 830 000	700	1 000
240	370	120	107	5	1.5	1 110 000	1 940 000	700	1 000
	370	150	120	5	1.5	1 460 000	2 760 000	700	1 000
	400	158	122	5	1.5	1 390 000	2 300 000	600	900
	400	92	82	4	1.5	780 000	1 490 000	700	900
250	360	115	92	4	1.5	1 020 000	2 040 000	700	900
	400	128	114	5	1.5	1 180 000	2 190 000	600	900
	400	160	128	5	1.5	1 620 000	3 050 000	600	900
260	400	209	168	5	1.5	2 220 000	4 450 000	600	900
	380	98	87	4	1	795 000	1 460 000	600	900
	400	104	92	5	1.5	895 000	1 670 000	600	800
	400	130	104	5	1.5	1 210 000	2 460 000	600	800
260	440	144	128	5	1.5	1 540 000	2 760 000	600	800
	440	172	145	5	1.5	1 870 000	3 500 000	600	800
	440	180	144	5	1.5	2 110 000	4 150 000	600	800

Remarks For other double-row tapered roller bearings not listed above, please contact NSK.

Bearing Numbers	Abutment and Fillet Dimensions (mm)				Constant e	Axial Load Factors			Mass (kg) approx.
	d _{a min.}	D _{b min.}	r _{a max.}	r _{b max.}		Y ₂	Y ₃	Y ₀	
206 KBE 2801+L	227	275	3	1.5	0.51	2.0	1.3	1.3	18.1
210 KBE 31+L	231	338	3	1.5	0.46	2.2	1.5	1.4	41.7
220 KBE 3001+L	238	292	2.5	1	0.37	2.7	1.8	1.8	21.2
220 KBE 30+L	241	324	3	1.5	0.40	2.5	1.7	1.6	27.9
220 KBE 030+L	241	327	3	1.5	0.40	2.5	1.7	1.6	34.7
220 KBE 31+L	247	345	4	1.5	0.39	2.6	1.7	1.7	48.3
220 KBE 031+L	247	349	4	1.5	0.39	2.6	1.7	1.7	60.2
220 KBE 42+L	247	371	4	1.5	0.40	2.5	1.7	1.6	74.2
240 KBE 30+L	261	344	3	1.5	0.39	2.6	1.7	1.7	30.1
240 KBE 030+L	261	344	3	1.5	0.35	2.9	2.0	1.9	37.3
240 KBE 31+L	267	380	4	1.5	0.43	2.3	1.6	1.5	60.0
240 KBE 031+L	267	378	4	1.5	0.39	2.6	1.7	1.7	73.6
240 KBE 4003+L	267	384	4	1.5	0.33	3.0	2.0	2.0	96.4
250 KBE 3801+L	271	365	3	1	0.40	2.5	1.7	1.6	35.5
260 KBE 30+L	287	379	4	1.5	0.40	2.5	1.7	1.6	43.4
260 KBE 030+L	287	382	4	1.5	0.40	2.5	1.7	1.6	54.1
260 KBE 31+L	287	416	4	1.5	0.39	2.6	1.7	1.7	82.5
260 KBE 4401+L	287	414	4	1.5	0.38	2.6	1.8	1.7	98.1
260 KBE 031+L	287	416	4	1.5	0.39	2.6	1.7	1.7	104.0

SPHERICAL ROLLER BEARINGS

SPHERICAL ROLLER BEARINGS

Cylindrical Bores, Tapered Bores	Bore Diameter	20 – 150mm	B184
	Bore Diameter	160 – 560mm	B192
	Bore Diameter	600 – 1400mm	B202

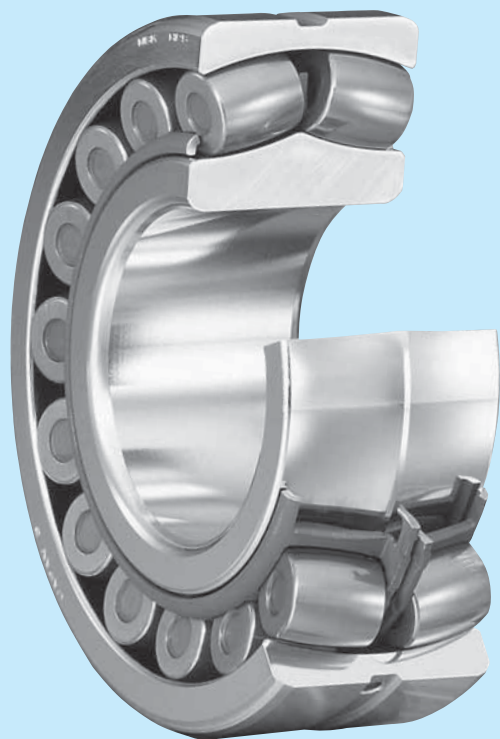

DESIGN, TYPES, AND FEATURES

Shown in the figures, types EA, C, CD, CA, which are designed for high load capacity, are available. Types EA, C and CD have pressed steel cages, and type CA has machined brass cages. The EA type bearings listed here are classified as NSKHPS bearings, which offer particularly high load-carrying capacity, high limiting speeds, and are highly functional under high-temperature operating conditions of up to 200°C.

An oil groove and holes are provided in the outer ring to supply lubricant and the bearing numbers are suffixed with E4.

To use bearings with oil grooves and holes, it is recommended to provide an oil groove in the housing bore, since the depth of the groove in the bearing is limited. The number and dimensions of the oil groove and holes are shown in Tables 1 and 2.

When bearings with a hole for a locking pin to prevent outer ring rotation are required, please inform NSK.

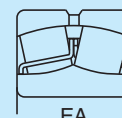

EA

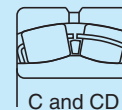

C and CD

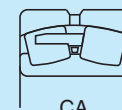

CA

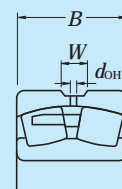

TOLERANCES AND RUNNING ACCURACY	Table 8.2 (Pages A60 to A63)
RECOMMENDED FITS	Table 9.2 (Page A84) Table 9.4 (Page A85)
INTERNAL CLEARANCE	Table 9.15 (Page A92)

PERMISSIBLE MISALIGNMENT

The permissible misalignment of spherical roller bearings varies depending on the size and load, but it is approximately 0.018 to 0.045 radian (1° to 2.5°) with normal loads.

LIMITING SPEEDS

The limiting speeds listed in the bearing tables should be adjusted depending on the bearing load conditions. Also, higher speeds are attainable by making changes in the lubrication method, cage design, etc. Refer to Page A37 for detailed information.

Table 1 Dimensions of Oil Grooves and Holes Units : mm

Nominal Width <i>B</i>	Oil Groove		Hole Diameter	
	over	incl.	Width <i>W</i>	<i>d</i> _{OH}
18	30	5	2.5	
30	40	6	3	
40	50	7	4	
50	65	8	5	
65	80	10	6	
80	100	12	8	
100	120	15	10	
120	160	20	12	
160	200	25	15	
200	250	30	20	
250	315	35	20	
315	400	40	25	
400	—	40	25	

Table 2 Number of Oil Holes

Nominal Outer Ring Dia <i>D</i> (mm)		Number of Holes
over	incl.	
—	180	4
180	250	6
250	315	6
315	400	6
400	500	6
500	630	8
630	800	8
800	1000	8
1000	1250	8
1250	1600	8
1600	2000	8

And if the load on spherical roller bearings becomes too small during operation or if the ratio of axial and radial loads is larger than the value of 'e' (listed in the bearing tables), slippage occurs between the rollers and raceways, which may result in smearing. The higher the weight of the rollers and cage, the higher this tendency becomes, especially for large spherical roller bearings.

If very small bearing loads are expected, please contact NSK for selection of an appropriate bearing.

Bore Diameter 20 – 55 mm

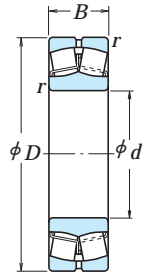

Cylindrical Bore

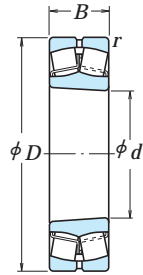

Tapered Bore



Without an Oil Groove or Holes

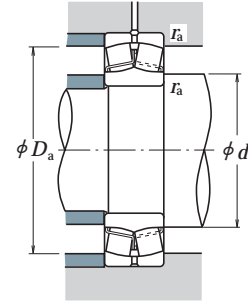

Dynamic Equivalent Load

$$P = XF_r + YF_a$$

$F_a/F_r \leq e$		$F_a/F_r > e$	
X	Y	X	Y
1	Y_3	0.67	Y_2

Static Equivalent Load

$$P_0 = F_r + Y_0 F_a$$

The values of e , Y_2 , Y_3 , and Y_0 are given in the table below.

Boundary Dimensions (mm)				Basic Load Ratings				Limiting Speeds		Bearing
d	D	B	$r_{min.}$	C_r (N)	C_{0r} (kgf)	C_r (kgf)	C_{0r} (kgf)	Grease	Oil	
20	52	15	1.1	29 300	26 900	2 980	2 740	6 300	8 200	21304CDE4
25	52	18	1	37 500	37 000	3 850	3 800	7 100	9 000	22205CE4
	62	17	1.1	43 000	40 500	4 350	4 150	5 300	6 700	21305CDE4
30	62	20	1	50 000	50 000	5 100	5 100	6 000	7 500	22206CE4
	72	19	1.1	55 000	54 000	5 600	5 500	4 500	6 000	21306CDE4
35	72	23	1.1	69 000	71 000	7 050	7 200	5 300	6 700	22207CE4
	80	21	1.5	71 500	76 000	7 250	7 750	4 000	5 300	21307CDE4
40	80	23	1.1	113 000	99 500	11 500	10 100	6 700	8 500	*22208EAE4
	90	23	1.5	118 000	111 000	12 000	11 300	6 000	7 500	*21308EAE4
	90	33	1.5	170 000	153 000	17 300	15 600	5 300	6 700	*22308EAE4
45	85	23	1.1	118 000	111 000	12 000	11 300	6 000	7 500	*22209EAE4
	100	25	1.5	149 000	144 000	15 200	14 600	5 000	6 300	*21309EAE4
	100	36	1.5	207 000	195 000	21 100	19 900	4 500	5 600	*22309EAE4
50	90	23	1.1	124 000	119 000	12 600	12 100	5 600	7 100	*22210EAE4
	110	27	2	178 000	174 000	18 100	17 800	4 500	5 600	*21310EAE4
	110	40	2	246 000	234 000	25 100	23 900	4 300	5 300	*22310EAE4
55	100	25	1.5	149 000	144 000	15 200	14 600	5 300	6 700	*22211EAE4
	120	29	2	178 000	174 000	18 100	17 800	4 500	5 600	*21311EAE4
	120	43	2	292 000	292 000	29 800	29 800	3 800	4 800	*22311EAE4

Note (1) The suffix K represents bearings with tapered bores (taper 1 : 12).

Numbers	Abutment and Fillet Dimensions (mm)					Constant	Axial Load Factors			Mass (kg)
	Tapered Bore ⁽¹⁾						e	Y_2	Y_3	
	min.	max.	max.	min.	max.					
21304CDKE4	27	28	45	42	1	0.31	3.2	2.1	2.1	0.17
22205CKE4 21305CDKE4	31	31	46	45	1	0.35	2.9	1.9	1.9	0.17
	32	34	55	51	1	0.29	3.4	2.3	2.3	0.26
22206CKE4 21306CDKE4	36	37	56	54	1	0.33	3.1	2.1	2.0	0.27
	37	40	65	59	1	0.28	3.6	2.4	2.3	0.39
22207CKE4 21307CDKE4	42	43	65	63	1	0.32	3.1	2.1	2.0	0.42
	44	47	71	67	1.5	0.28	3.6	2.4	2.4	0.53
*22208EAKE4 *21308EAKE4 *22308EAKE4	47	49	73	70	1	0.28	3.6	2.4	2.4	0.50
	49	54	81	75	1.5	0.25	3.9	2.7	2.6	0.73
	49	52	81	77	1.5	0.35	2.8	1.9	1.9	0.98
*22209EAKE4 *21309EAKE4 *22309EAKE4	52	54	78	75	1	0.25	3.9	2.7	2.6	0.55
	54	65	91	89	1.5	0.23	4.3	2.9	2.8	0.96
	54	59	91	86	1.5	0.34	2.9	2.0	1.9	1.34
*22210EAKE4 *21310EAKE4 *22310EAKE4	57	60	83	81	1	0.24	4.3	2.9	2.8	0.61
	60	72	100	98	2	0.23	4.4	3.0	2.9	1.21
	60	64	100	93	2	0.35	2.8	1.9	1.9	1.78
*22211EAKE4 *21311EAKE4 *22311EAKE4	64	65	91	89	1.5	0.23	4.3	2.9	2.8	0.81
	65	72	110	98	2	0.23	4.4	3.0	2.9	1.58
	65	73	110	103	2	0.34	2.9	2.0	1.9	2.3

Remarks 1. The bearings denoted by an asterisk (*) are NSKHPS bearings and an oil groove and holes are standard for them.
 2. When making a selection of the recommended fit (Tolerance of Shaft) on Page A84 of the NSK Rolling Bearings catalog, in case of NSKHPS bearings, the conditions are different.
 The segmentations are: Light Loads ($\leq 0.05C_r$); Normal Loads (0.05 to 0.10 C_r); and Heavy Loads (>0.10 C_r).
 3. For the dimensions of adapters and withdrawal sleeves, refer to Pages B358 – B359, and B366.

Bore Diameter 60 – 85 mm

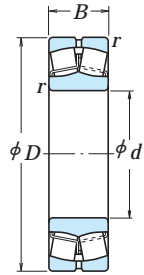

Cylindrical Bore

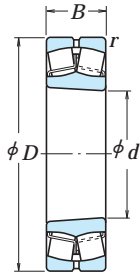

Tapered Bore

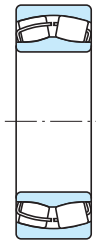

Without an Oil Groove or Holes

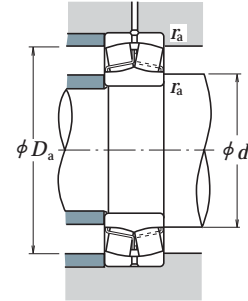

Dynamic Equivalent Load

$$P = XF_r + YF_a$$

$F_a/F_r \leq e$		$F_a/F_r > e$	
X	Y	X	Y
1	Y_3	0.67	Y_2

Static Equivalent Load

$$P_0 = F_r + Y_0 F_a$$

The values of e , Y_2 , Y_3 , and Y_0 are given in the table below.

Boundary Dimensions (mm)				Basic Load Ratings (N)				Limiting Speeds (min ⁻¹)		Bearing
d	D	B	$r_{min.}$	C_r	C_{0r}	{kgf}		Grease	Oil	
60	95	26	1.1	98 500	141 000	10 000	14 400	3 600	4 500	23012CE4
	110	28	1.5	178 000	174 000	18 100	17 800	4 800	6 000	*22212EAE4
	130	31	2.1	238 000	244 000	24 200	24 900	3 800	4 800	*21312EAE4
	130	46	2.1	340 000	340 000	34 500	35 000	3 600	4 500	*22312EAE4
65	120	31	1.5	221 000	230 000	22 500	23 500	4 300	5 300	*22213EAE4
	140	33	2.1	264 000	275 000	27 000	28 000	3 600	4 500	*21313EAE4
	140	48	2.1	375 000	380 000	38 000	38 500	3 200	4 000	*22313EAE4
70	125	31	1.5	225 000	232 000	22 900	23 600	4 000	5 300	*22214EAE4
	150	35	2.1	310 000	325 000	32 000	33 500	3 200	4 000	*21314EAE4
	150	51	2.1	425 000	435 000	43 500	44 000	3 000	3 800	*22314EAE4
75	130	31	1.5	238 000	244 000	24 200	24 900	4 000	5 000	*22215EAE4
	160	37	2.1	310 000	325 000	32 000	33 500	3 200	4 000	*21315EAE4
	160	55	2.1	485 000	505 000	49 500	51 500	2 800	3 600	*22315EAE4
80	140	33	2	264 000	275 000	27 000	28 000	3 600	4 500	*22216EAE4
	170	39	2.1	355 000	375 000	36 000	38 000	3 000	3 800	*21316EAE4
	170	58	2.1	540 000	565 000	55 000	58 000	2 600	3 400	*22316EAE4
85	150	36	2	310 000	325 000	32 000	33 500	3 400	4 300	*22217EAE4
	180	41	3	360 000	395 000	37 000	40 000	3 000	4 000	*21317EAE4
	180	60	3	600 000	630 000	61 000	64 000	2 400	3 200	*22317EAE4

Note (1) The suffix K represents bearings with tapered bores (taper 1 : 12).

Numbers	Abutment and Fillet Dimensions (mm)					Constant	Axial Load Factors			Mass (kg)
	Tapered Bore ⁽¹⁾						e	Y_2	Y_3	
23012CKE4 *22212EAKE4 *21312EAKE4 *22312EAKE4	min.	max.	max.	min.	max.					approx.
	67	68	88	85	1	0.26	3.9	2.6	2.5	0.68
	69	72	101	98	1.5	0.23	4.4	3.0	2.9	1.1
	72	87	118	117	2	0.22	4.5	3.0	3.0	1.98
*22213EAKE4 *21313EAKE4 *22313EAKE4	74	80	111	107	1.5	0.24	4.2	2.8	2.7	1.51
	77	94	128	126	2	0.22	4.6	3.1	3.0	2.45
	77	84	128	119	2	0.33	3.0	2.0	2.0	3.52
*22214EAKE4 *21314EAKE4 *22314EAKE4	79	84	116	111	1.5	0.23	4.3	2.9	2.8	1.58
	82	101	138	135	2	0.22	4.6	3.1	3.0	3.0
	82	91	138	129	2	0.33	3.0	2.0	2.0	4.28
*22215EAKE4 *21315EAKE4 *22315EAKE4	84	87	121	117	1.5	0.22	4.5	3.0	3.0	1.64
	87	101	148	134	2	0.22	4.6	3.1	3.0	3.64
	87	97	148	137	2	0.33	3.0	2.0	2.0	5.26
*22216EAKE4 *21316EAKE4 *22316EAKE4	90	94	130	126	2	0.22	4.6	3.1	3.0	2.01
	92	109	158	146	2	0.23	4.4	3.0	2.9	4.32
	92	103	158	145	2	0.33	3.0	2.0	2.0	6.23
*22217EAKE4 *21317EAKE4 *22317EAKE4	95	101	140	135	2	0.22	4.6	3.1	3.0	2.54
	99	108	166	142	2.5	0.24	4.3	2.9	2.8	5.2
	99	110	166	155	2.5	0.33	3.1	2.1	2.0	7.23

- Remarks
- The bearings denoted by an asterisk (*) are NSKHPS bearings and an oil groove and holes are standard for them.
 - When making a selection of the recommended fit (Tolerance of Shaft) on Page A84 of the NSK Rolling Bearings catalog, in case of NSKHPS bearings, the conditions are different.
The segmentations are: Light Loads ($\leq 0.05C_r$); Normal Loads (0.05 to 0.10 C_r); and Heavy Loads (>0.10 C_r).
 - For the dimensions of adapters and withdrawal sleeves, refer to Pages B359 – B361, and B366.

Bore Diameter 90 – 110 mm

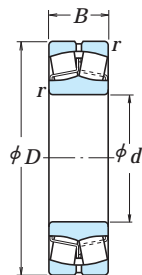

Cylindrical Bore

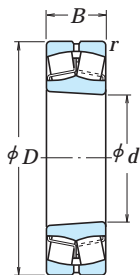

Tapered Bore

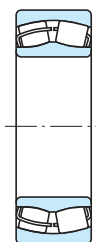

Without an Oil Groove or Holes

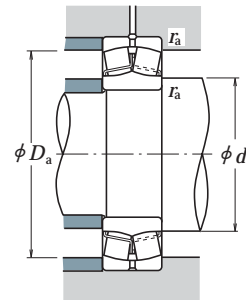

Dynamic Equivalent Load

$$P = XF_r + YF_a$$

$F_a/F_r \leq e$		$F_a/F_r > e$	
X	Y	X	Y
1	Y_3	0.67	Y_2

Static Equivalent Load

$$P_0 = F_r + Y_0 F_a$$

The values of e , Y_2 , Y_3 , and Y_0 are given in the table below.

Boundary Dimensions (mm)	Basic Load Ratings				Limiting Speeds		Bearing
	C_r	C_{0r}	C_r	C_{0r}	Grease	Oil	
d D B $r_{min.}$	(N)	(kgf)	(min ⁻¹)	Cylindrical Bore			
90	160 40 2	360 000 395 000	37 000 40 000	*22218EAE4	3 200 4 000		
	160 52.4 2	340 000 490 000	34 500 50 000	23218CE4	1 800 2 400		
	190 43 3	415 000 450 000	42 000 46 000	*21318EAE4	2 800 3 600		
	190 64 3	665 000 705 000	68 000 72 000	*22318EAE4	2 400 3 000		
95	170 43 2.1	415 000 450 000	42 000 46 000	*22219EAE4	3 000 3 800		
	170 55.6 2.1	370 000 525 000	37 500 53 500	23219CAE4	1 700 2 200		
	200 45 3	345 000 435 000	35 000 44 500	21319CE4	1 500 2 000		
	200 67 3	735 000 780 000	75 000 79 500	*22319EAE4	2 200 2 800		
100	150 37 1.5	212 000 335 000	21 600 34 500	23020CDE4	2 200 2 800		
	150 50 1.5	276 000 470 000	28 100 48 000	24020CE4	1 800 2 400		
	165 52 2	345 000 530 000	35 500 54 000	23120CE4	1 700 2 200		
	165 65 2	345 000 535 000	35 000 55 000	24120CAE4	1 700 2 200		
	180 46 2.1	455 000 490 000	46 500 50 000	*22220EAE4	2 800 3 600		
	180 60.3 2.1	420 000 605 000	42 500 61 500	23220CE4	1 600 2 200		
	215 47 3	395 000 485 000	40 500 49 500	21320CE4	1 400 1 900		
	215 73 3	860 000 930 000	88 000 94 500	*22320EAE4	2 000 2 600		
110	170 45 2	293 000 465 000	29 900 47 500	23022CDE4	2 000 2 400		
	170 60 2	380 000 645 000	38 500 66 000	24022CE4	1 600 2 200		
	180 56 2	385 000 630 000	39 500 64 000	23122CE4	1 600 2 000		
	180 69 2	460 000 750 000	47 000 76 500	24122CE4	1 600 2 000		
	200 53 2.1	605 000 645 000	61 500 66 000	*22222EAE4	2 600 3 200		
	200 69.8 2.1	515 000 760 000	52 500 77 500	23222CE4	1 500 1 900		
	240 50 3	450 000 545 000	46 000 55 500	21322CAE4	1 300 1 700		
	240 80 3	1030 000 1 120 000	105 000 115 000	*22322EAE4	1 900 2 400		

Note (1) The suffix K or K30 represents bearings with tapered bores (taper 1 : 12 or 1 : 30).

Numbers	Abutment and Fillet Dimensions (mm)					Constant	Axial Load Factors			Mass (kg)
	Tapered Bore(1)		d_a	D_a	r_a		e	Y_2	Y_3	
*22218EAKE4	100	108	150	142	2	0.24	4.3	2.9	2.8	3.3
23218CKE4	100	105	150	138	2	0.32	3.2	2.1	2.1	4.51
*21318EAKE4	104	115	176	152	2.5	0.24	4.3	2.9	2.8	6.1
*22318EAKE4	104	115	176	163	2.5	0.33	3.1	2.1	2.0	8.56
*22219EAKE4	107	115	158	152	2	0.24	4.3	2.9	2.8	4.04
23219CAKE4	107	—	158	146	2	0.32	3.1	2.1	2.0	5.33
21319CKE4	109	127	186	172	2.5	0.22	4.6	3.1	3.0	6.92
*22319EAKE4	109	121	186	172	2.5	0.33	3.1	2.1	2.0	9.91
23020CDKE4	109	112	141	136	1.5	0.22	4.6	3.1	3.0	2.31
24020CK30E4	109	110	141	132	1.5	0.30	3.4	2.3	2.2	3.08
23120CKE4	110	113	155	144	2	0.30	3.4	2.3	2.2	4.38
24120CAK30E4	110	—	155	143	2	0.35	2.9	1.9	1.9	5.42
*22220EAKE4	112	119	168	160	2	0.24	4.3	2.9	2.8	4.84
23220CKE4	112	118	168	155	2	0.32	3.2	2.1	2.1	6.6
21320CKE4	114	133	201	184	2.5	0.21	4.7	3.2	3.1	8.46
*22320EAKE4	114	130	201	184	2.5	0.33	3.0	2.0	2.0	12.7
23022CDKE4	120	124	160	153	2	0.24	4.2	2.8	2.8	3.76
24022CK30E4	120	121	160	148	2	0.32	3.1	2.1	2.1	4.96
23122CKE4	120	127	170	158	2	0.28	3.5	2.4	2.3	5.7
24122CK30E4	120	123	170	154	2	0.36	2.8	1.9	1.8	6.84
*22222EAKE4	122	129	188	178	2	0.25	4.0	2.7	2.6	6.99
23222CKE4	122	130	188	170	2	0.34	3.0	2.0	1.9	9.54
21322CAKE4	124	—	226	206	2.5	0.22	4.6	3.1	3.0	11.2
*22322EAKE4	124	145	226	206	2.5	0.33	3.1	2.1	2.0	17.6

Remarks 1. The bearings denoted by an asterisk (*) are NSKHPS bearings and an oil groove and holes are standard for them.
 2. When making a selection of the recommended fit (Tolerance of Shaft) on Page A84 of the NSK Rolling Bearings catalog, in case of NSKHPS bearings, the conditions are different.
 The segmentations are: Light Loads ($\leq 0.05C_r$); Normal Loads (0.05 to 0.10 C_r); and Heavy Loads (>0.10 C_r).
 3. For the dimensions of adapters and withdrawal sleeves, refer to Pages B360 – B361, and B366 – B367.

Bore Diameter 120 – 150 mm

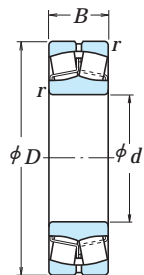

Cylindrical Bore

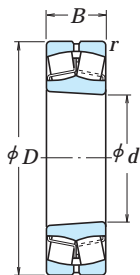

Tapered Bore

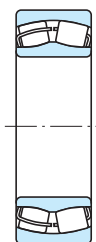

Without an Oil Groove or Holes

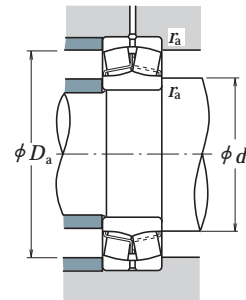

Dynamic Equivalent Load

$$P = XF_r + YF_a$$

$F_a/F_r \leq e$		$F_a/F_r > e$	
X	Y	X	Y
1	Y_3	0.67	Y_2

Static Equivalent Load

$$P_0 = F_r + Y_0 F_a$$

The values of e , Y_2 , Y_3 , and Y_0 are given in the table below.

Boundary Dimensions (mm)	Basic Load Ratings				Limiting Speeds		Bearing			
	d	D	B	$r_{min.}$	(N)	(kgf)		(min ⁻¹)		
				C_r	C_{0r}	C_r	C_{0r}	Grease	Oil	Cylindrical Bore
120	180	46	2	315 000	525 000	32 000	53 500	1 800	2 200	23024CDE4
	180	60	2	395 000	705 000	40 500	72 000	1 500	2 000	24024CE4
	200	62	2	465 000	720 000	47 500	73 500	1 400	1 800	23124CE4
	200	80	2	575 000	950 000	58 500	96 500	1 400	1 800	24124CE4
	215	58	2.1	685 000	765 000	70 000	78 000	2 400	3 000	*22224EAE4
	215	76	2.1	630 000	970 000	64 500	99 000	1 300	1 700	23224CE4
260	86	3	1190 000	1 320 000	122 000	134 000	1 700	2 200	*23224EAE4	
130	200	52	2	400 000	655 000	40 500	67 000	1 700	2 000	23026CDE4
	200	69	2	495 000	865 000	50 500	88 000	1 400	1 800	24026CE4
	210	64	2	505 000	825 000	51 500	84 500	1 300	1 700	23126CE4
	210	80	2	590 000	1 010 000	60 000	103 000	1 300	1 700	24126CE4
	230	64	3	820 000	940 000	83 500	96 000	2 200	2 600	*22226EAE4
	230	80	3	700 000	1 080 000	71 500	110 000	1 200	1 600	23226CE4
280	93	4	995 000	1 350 000	101 000	137 000	1 300	1 600	22326CE4	
140	210	53	2	420 000	715 000	43 000	73 000	1 600	1 900	23028CDE4
	210	69	2	525 000	945 000	53 500	96 500	1 300	1 700	24028CE4
	225	68	2.1	580 000	945 000	59 000	96 500	1 200	1 600	23128CE4
	225	85	2.1	670 000	1 160 000	68 500	118 000	1 200	1 600	24128CE4
	250	68	3	645 000	930 000	65 500	95 000	1 400	1 700	22228CDE4
	250	88	3	835 000	1 300 000	85 000	133 000	1 100	1 500	23228CE4
300	102	4	1 160 000	1 590 000	118 000	162 000	1 200	1 500	22328CE4	
150	225	56	2.1	470 000	815 000	48 000	83 000	1 400	1 800	23030CDE4
	225	75	2.1	590 000	1 090 000	60 500	111 000	1 200	1 500	24030CE4
	250	80	2.1	725 000	1 180 000	74 000	121 000	1 100	1 400	23130CE4
	250	100	2.1	890 000	1 530 000	91 000	156 000	1 100	1 400	24130CE4
	270	73	3	765 000	1 120 000	78 000	114 000	1 300	1 600	22230CDE4
	270	96	3	975 000	1 560 000	99 500	159 000	1 100	1 400	23230CE4
320	108	4	1 220 000	1 690 000	125 000	172 000	1 100	1 400	22330CAE4	

Note (1) The suffix K or K30 represents bearings with tapered bores (taper 1 : 12 or 1 : 30).

Numbers	Abutment and Fillet Dimensions (mm)					Constant	Axial Load Factors			Mass (kg)
	Tapered Bore(1)		d_a	D_a	r_a		e	Y_2	Y_3	
	min.	max.	max.	min.	max.					approx.
23024CDKE4 24024CK30E4 23124CKE4	130	134	170	163	2	0.22	4.5	3.0	2.9	4.11
	130	131	170	158	2	0.32	3.2	2.1	2.1	5.33
	130	138	190	175	2	0.29	3.5	2.4	2.3	7.85
24124CK30E4 *22224EAKE4 23224CKE4 *23224EAKE4	130	136	190	171	2	0.37	2.7	1.8	1.8	10
	132	142	203	190	2	0.25	3.9	2.7	2.6	8.8
	132	140	203	182	2	0.34	2.9	2.0	1.9	12.1
	134	157	246	222	2.5	0.32	3.1	2.1	2.0	22.2
23026CDKE4 24026CK30E4 23126CKE4	140	147	190	180	2	0.23	4.3	2.9	2.8	5.98
	140	143	190	175	2	0.31	3.2	2.2	2.1	7.84
	140	149	200	184	2	0.28	3.6	2.4	2.4	8.69
24126CK30E4 *22226EAKE4 23226CKE4 22326CKE4	140	146	200	180	2	0.35	2.9	1.9	1.9	10.7
	144	152	216	204	2.5	0.26	3.8	2.6	2.5	11
	144	150	216	196	2.5	0.34	2.9	2.0	1.9	14.3
	148	166	262	236	3	0.34	2.9	2.0	1.9	28.1
23028CDKE4 24028CK30E4 23128CKE4	150	157	200	190	2	0.22	4.5	3.0	2.9	6.49
	150	154	200	186	2	0.29	3.4	2.3	2.2	8.37
	152	158	213	198	2	0.28	3.6	2.4	2.3	10.5
24128CK30E4 22228CDE4 23228CKE4 22328CKE4	152	156	213	193	2	0.35	2.9	1.9	1.9	13
	154	167	236	219	2.5	0.25	4.0	2.7	2.6	14.5
	154	163	236	213	2.5	0.35	2.9	1.9	1.9	18.8
	158	177	282	253	3	0.35	2.9	1.9	1.9	35.4
23030CDKE4 24030CK30E4 23130CKE4	162	168	213	203	2	0.22	4.6	3.1	3.0	7.9
	162	165	213	198	2	0.30	3.4	2.3	2.2	10.5
	162	174	238	218	2	0.30	3.4	2.3	2.2	15.8
24130CK30E4 22230CDE4 23230CKE4 22330CAE4	162	169	238	212	2	0.38	2.6	1.8	1.7	19.8
	164	179	256	236	2.5	0.26	3.9	2.6	2.5	18.4
	164	176	256	230	2.5	0.35	2.9	1.9	1.9	24.2
	168	—	302	270	3	0.35	2.9	1.9	1.9	41.5

Remarks 1. The bearings denoted by an asterisk (*) are NSKHPS bearings and an oil groove and holes are standard for them.
 2. When making a selection of the recommended fit (Tolerance of Shaft) on Page A84 of the NSK Rolling Bearings catalog, in case of NSKHPS bearings, the conditions are different.
 The segmentations are: Light Loads ($\leq 0.05C_r$); Normal Loads (0.05 to 0.10 C_r); and Heavy Loads (>0.10 C_r).
 3. For the dimensions of adapters and withdrawal sleeves, refer to Pages B361 – B362, and B367 – B368.

Bore Diameter 160 – 190 mm

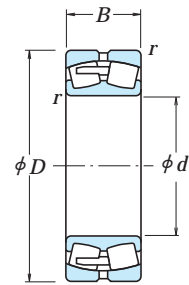

Cylindrical Bore

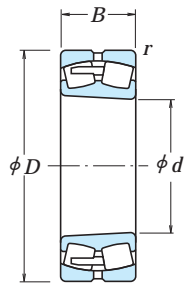

Tapered Bore



Without an Oil Groove and Holes

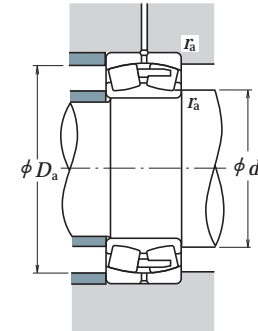

Dynamic Equivalent Load

$$P = X F_r + Y F_a$$

$F_a / F_r \leq e$		$F_a / F_r > e$	
X	Y	X	Y
1	Y_3	0.67	Y_2

Static Equivalent Load

$$P_0 = F_r + Y_0 F_a$$

The values of e , Y_2 , Y_3 , and Y_0 are given in the table below.

Boundary Dimensions (mm)	Basic Load Ratings				Limiting Speeds		Bearing
	C_r	C_{0r}	C_r	C_{0r}	Grease	Oil	
d D B $r_{min.}$	(N)	(kgf)	(kgf)	(kgf)	(min ⁻¹)		Cylindrical Bore
160	220 45 2	360 000 675 000	37 000 69 000	1 400 1 800	23932CAE4		
	240 60 2.1	540 000 955 000	55 000 97 500	1 300 1 700	23032CDE4		
	240 80 2.1	680 000 1 260 000	69 000 128 000	1 100 1 400	24032CE4		
	270 86 2.1	855 000 1 400 000	87 000 143 000	1 000 1 300	23132CE4		
	270 109 2.1	1 040 000 1 760 000	106 000 179 000	1 000 1 300	24132CE4		
	290 80 3	910 000 1 320 000	93 000 135 000	1 200 1 500	22232CDE4		
	290 104 3	1 100 000 1 770 000	112 000 180 000	1 000 1 300	23232CE4		
	340 114 4	1 360 000 1 900 000	139 000 193 000	1 100 1 300	22332CAE4		
170	230 45 2	350 000 660 000	35 500 67 500	1 400 1 800	23934BCAE4		
	260 67 2.1	640 000 1 090 000	65 000 112 000	1 200 1 600	23034CDE4		
	260 90 2.1	825 000 1 520 000	84 000 155 000	1 000 1 300	24034CE4		
	280 88 2.1	940 000 1 570 000	96 000 160 000	1 000 1 300	23134CE4		
	280 109 2.1	1 080 000 1 860 000	110 000 190 000	1 000 1 300	24134CE4		
	310 86 4	990 000 1 500 000	101 000 153 000	1 100 1 400	22234CDE4		
	310 110 4	1 200 000 1 910 000	122 000 195 000	900 1 200	23234CE4		
	360 120 4	1 580 000 2 110 000	161 000 215 000	1 000 1 200	22334CAE4		
180	250 52 2	470 000 890 000	48 000 90 500	1 200 1 600	23936CAE4		
	280 74 2.1	750 000 1 270 000	76 000 129 000	1 200 1 400	23036CDE4		
	280 100 2.1	965 000 1 750 000	98 500 178 000	950 1 200	24036CE4		
	300 96 3	1 050 000 1 760 000	108 000 180 000	900 1 200	23136CE4		
	300 118 3	1 190 000 2 040 000	121 000 208 000	900 1 200	24136CE4		
	320 86 4	1 020 000 1 540 000	104 000 157 000	1 100 1 300	22236CDE4		
	320 112 4	1 300 000 2 110 000	133 000 215 000	850 1 100	23236CE4		
	380 126 4	1 740 000 2 340 000	177 000 238 000	950 1 200	22336CAE4		
190	260 52 2	460 000 875 000	47 000 89 500	1 200 1 500	23938CAE4		
	290 75 2.1	775 000 1 350 000	79 000 138 000	1 100 1 400	23038CDE4		
	290 100 2.1	975 000 1 840 000	99 500 188 000	900 1 200	24038CE4		
	320 104 3	1 190 000 2 020 000	121 000 206 000	850 1 100	23138CE4		
	320 128 3	1 370 000 2 330 000	140 000 238 000	850 1 100	24138CE4		
	340 92 4	1 140 000 1 730 000	116 000 176 000	1 000 1 200	22238CAE4		
	340 120 4	1 440 000 2 350 000	147 000 240 000	800 1 100	23238CE4		
	400 132 5	1 890 000 2 590 000	193 000 264 000	900 1 100	22338CAE4		

Note (1) The suffix K or K30 represents bearings with tapered bores (taper 1 : 12 or 1 : 30).

Numbers	Abutment and Fillet Dimensions (mm)						Constant	Axial Load Factors			Mass (kg)
	d_a		D_a		r_a			e	Y_2	Y_3	
Tapered Bore(1)	min.	max.	max.	min.	max.	max.					approx.
23932CAKE4	170	—	210	203	2	0.18	5.6	3.8	3.7	4.97	
23032CDKE4	172	179	228	216	2	0.22	4.5	3.0	2.9	9.66	
24032CK30E4	172	177	228	212	2	0.30	3.4	2.3	2.2	12.7	
23132CKE4	172	185	258	234	2	0.30	3.4	2.3	2.2	20.3	
24132CK30E4	172	179	258	229	2	0.39	2.6	1.7	1.7	25.4	
22232CDKE4	174	190	276	255	2.5	0.26	3.8	2.6	2.5	23.1	
23232CKE4	174	189	276	245	2.5	0.34	2.9	2.0	1.9	30.5	
22332CAE4	178	—	322	287	3	0.35	2.9	1.9	1.9	49.3	
23934BCAKE4	180	—	220	213	2	0.17	5.8	3.9	3.8	5.38	
23034CDKE4	182	191	248	233	2	0.23	4.3	2.9	2.8	13	
24034CK30E4	182	188	248	228	2	0.31	3.2	2.2	2.1	17.3	
23134CKE4	182	194	268	245	2	0.29	3.5	2.3	2.3	21.8	
24134CK30E4	182	190	268	239	2	0.37	2.7	1.8	1.8	26.6	
22234CDKE4	188	206	292	270	3	0.26	3.8	2.6	2.5	28.8	
23234CKE4	188	201	292	261	3	0.34	2.9	2.0	1.9	36.4	
22334CAE4	188	—	342	304	3	0.35	2.9	1.9	1.9	57.9	
23936CAKE4	190	—	240	230	2	0.18	5.5	3.7	3.6	7.64	
23036CDKE4	192	202	268	249	2	0.24	4.2	2.8	2.8	17.1	
24036CK30E4	192	200	268	245	2	0.32	3.1	2.1	2.0	22.7	
23136CKE4	194	206	286	260	2.5	0.30	3.4	2.3	2.2	27.5	
24136CK30E4	194	202	286	255	2.5	0.37	2.7	1.8	1.8	33.1	
22236CDKE4	198	212	302	278	3	0.26	3.9	2.6	2.6	30.2	
23236CKE4	198	211	302	274	3	0.33	3.0	2.0	2.0	38.9	
22336CAE4	198	—	362	322	3	0.34	2.9	2.0	1.9	67	
23938CAKE4	200	—	250	240	2	0.18	5.7	3.8	3.7	8.03	
23038CAKE4	202	—	278	261	2	0.24	4.2	2.8	2.8	17.6	
24038CK30E4	202	210	278	253	2	0.31	3.2	2.2	2.1	24	
23138CKE4	204	219	306	276	2.5	0.31	3.3	2.2	2.2	34.5	
24138CK30E4	204	211	306	269	2.5	0.40	2.5	1.7	1.6	41.5	
22238CAKE4	208	—	322	296	3	0.26	3.8	2.6	2.5	35.5	
23238CKE4	208	222	322	288	3	0.35	2.9	1.9	1.9	47.6	
22338CAE4	212	—	378	338	4	0.34	2.9	2.0	1.9	77.6	

Remarks For the dimensions of adapters and withdrawal sleeves, refer to Pages B362 and B368.

Bore Diameter 200 – 260 mm

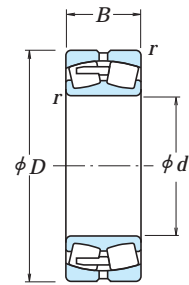

Cylindrical Bore

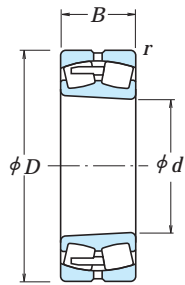

Tapered Bore



Without an Oil Groove and Holes

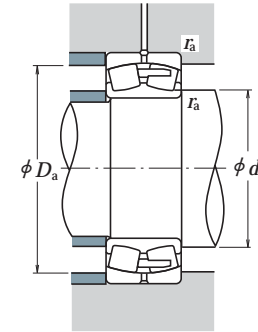

Dynamic Equivalent Load

$$P = XF_r + YF_a$$

$F_a/F_r \leq e$		$F_a/F_r > e$	
X	Y	X	Y
1	Y_3	0.67	Y_2

Static Equivalent Load

$$P_0 = F_r + Y_0 F_a$$

The values of e , Y_2 , Y_3 , and Y_0 are given in the table below.

Boundary Dimensions (mm)	Basic Load Ratings				Limiting Speeds		Bearing
	C_r	C_{0r}	C_r	C_{0r}	Grease	Oil	
d D B $r_{min.}$	(N)	(kgf)	(min ⁻¹)	Cylindrical Bore			
200	280 60 2.1	570 000 1 060 000	58 000 108 000	1 100 1 400	23940CAE4		
	310 82 2.1	940 000 1 700 000	96 000 174 000	1 000 1 300	23040CAE4		
	310 109 2.1	1 140 000 2 120 000	116 000 216 000	850 1 100	24040CE4		
	340 112 3	1 360 000 2 330 000	139 000 238 000	800 1 000	23140CE4		
	340 140 3	1 570 000 2 670 000	160 000 272 000	800 1 000	24140CE4		
	360 98 4	1 300 000 2 010 000	133 000 204 000	950 1 200	22240CAE4		
	360 128 4	1 660 000 2 750 000	169 000 281 000	750 1 000	23240CE4		
	420 138 5	2 000 000 2 990 000	204 000 305 000	850 1 000	22340CAE4		
220	300 60 2.1	625 000 1 240 000	64 000 126 000	1 000 1 300	23944CAE4		
	340 90 3	1 090 000 1 980 000	111 000 202 000	950 1 200	23044CAE4		
	340 118 3	1 360 000 2 600 000	138 000 265 000	750 1 000	24044CE4		
	370 120 4	1 570 000 2 710 000	160 000 276 000	710 950	23144CE4		
	370 150 4	1 800 000 3 200 000	183 000 325 000	710 950	24144CE4		
	400 108 4	1 570 000 2 430 000	160 000 247 000	850 1 000	22244CAE4		
	400 144 4	2 020 000 3 400 000	206 000 350 000	670 900	23244CE4		
	460 145 5	2 350 000 3 400 000	240 000 345 000	750 950	22344CAE4		
240	320 60 2.1	635 000 1 300 000	65 000 133 000	950 1 200	23948CAE4		
	360 92 3	1 160 000 2 140 000	118 000 218 000	850 1 100	23048CAE4		
	360 118 3	1 390 000 2 730 000	141 000 278 000	710 950	24048CE4		
	400 128 4	1 790 000 3 100 000	182 000 320 000	670 850	23148CE4		
	400 160 4	2 130 000 3 800 000	217 000 385 000	670 850	24148CE4		
	440 120 4	1 870 000 2 890 000	191 000 294 000	750 950	22248CAE4		
	440 160 4	2 440 000 4 050 000	249 000 415 000	630 800	23248CAE4		
	500 155 5	2 600 000 3 800 000	265 000 385 000	670 850	22348CAE4		
260	360 75 2.1	930 000 1 870 000	95 000 191 000	850 1 000	23952CAE4		
	400 104 4	1 430 000 2 580 000	145 000 263 000	800 950	23052CAE4		
	400 140 4	1 810 000 3 500 000	185 000 360 000	630 850	24052CAE4		
	440 144 4	2 160 000 3 750 000	221 000 385 000	600 800	23152CAE4		
	440 180 4	2 560 000 4 700 000	261 000 480 000	600 800	24152CAE4		
	480 130 5	2 180 000 3 400 000	222 000 345 000	670 850	22252CAE4		
	480 174 5	2 740 000 4 550 000	279 000 460 000	560 750	23252CAE4		
	540 165 6	3 100 000 4 600 000	320 000 470 000	630 800	22352CAE4		

Note (1) The suffix K or K30 represents bearings with tapered bores (taper 1 : 12 or 1 : 30).

Numbers	Abutment and Fillet Dimensions (mm)						Constant	Axial Load Factors			Mass (kg)
	d_a	D_a	r_a	e	Y_2	Y_3		Y_0			
Tapered Bore(1)	min.	max.	max.	min.	max.					approx.	
23940CAKE4	212	—	268	258	2	0.20	5.1	3.4	3.3	11	
23040CAKE4	212	—	298	279	2	0.25	4.0	2.7	2.6	22.6	
24040CK30E4	212	223	298	271	2	0.32	3.1	2.1	2.0	30.4	
23140CKE4	214	232	326	293	2.5	0.31	3.2	2.2	2.1	42.7	
24140CK30E4	214	226	326	290	2.5	0.39	2.6	1.8	1.7	51.3	
22240CAKE4	218	—	342	315	3	0.26	3.8	2.6	2.5	42.6	
23240CKE4	218	237	342	307	3	0.34	2.9	2.0	1.9	57.1	
22340CAKE4	222	—	398	352	4	0.34	2.9	2.0	1.9	92.6	
23944CAKE4	232	—	288	278	2	0.18	5.7	3.8	3.7	12.2	
23044CAKE4	234	—	326	302	2.5	0.24	4.1	2.8	2.7	29.7	
24044CK30E4	234	244	326	296	2.5	0.31	3.2	2.1	2.1	40.5	
23144CKE4	238	254	352	320	3	0.30	3.3	2.2	2.2	53	
24144CK30E4	238	248	352	313	3	0.39	2.6	1.7	1.7	66.7	
22244CAKE4	238	—	382	348	3	0.27	3.7	2.5	2.4	59	
23244CKE4	238	260	382	337	3	0.35	2.9	1.9	1.9	80.4	
22344CAKE4	242	—	438	391	4	0.33	3.0	2.0	2.0	116	
23948CAKE4	252	—	308	298	2	0.17	6.0	4.0	3.9	13.3	
23048CAKE4	254	—	346	324	2.5	0.24	4.2	2.8	2.7	32.6	
24048CK30E4	254	265	346	317	2.5	0.29	3.4	2.3	2.2	43.4	
23148CKE4	258	275	382	347	3	0.30	3.3	2.2	2.2	66.9	
24148CK30E4	258	268	382	341	3	0.38	2.7	1.8	1.8	79.5	
22248CAKE4	258	—	422	383	3	0.27	3.7	2.5	2.4	80.2	
23248CAKE4	258	—	422	372	3	0.37	2.7	1.8	1.8	106	
22348CAKE4	262	—	478	423	4	0.32	3.2	2.1	2.1	147	
23952CAKE4	272	—	348	333	2	0.19	5.4	3.6	3.5	23	
23052CAKE4	278	—	382	356	3	0.25	4.1	2.7	2.7	46.6	
24052CAK30E4	278	—	382	348	3	0.32	3.1	2.1	2.1	62.6	
23152CAKE4	278	—	422	380	3	0.32	3.2	2.1	2.1	88.2	
24152CAK30E4	278	—	422	371	3	0.39	2.6	1.7	1.7	109	
22252CAKE4	282	—	458	418	4	0.27	3.7	2.5	2.5	104	
23252CAKE4	282	—	458	406	4	0.37	2.7	1.8	1.8	137	
22352CAKE4	288	—	512	462	5	0.32	3.2	2.1	2.1	180	

Remarks For the dimensions of adapters and withdrawal sleeves, refer to Pages B363 and B369.

Bore Diameter 280 – 340 mm

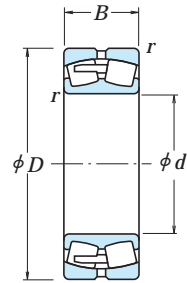

Cylindrical Bore

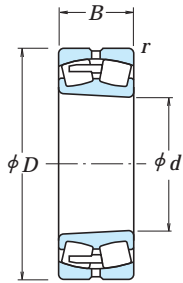

Tapered Bore



Without an Oil Groove and Holes

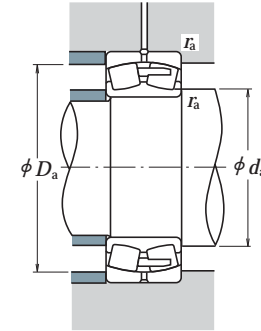

Dynamic Equivalent Load

$$P = XF_r + YF_a$$

$F_a / F_r \leq e$		$F_a / F_r > e$	
X	Y	X	Y
1	Y_3	0.67	Y_2

Static Equivalent Load

$$P_0 = F_r + Y_0 F_a$$

The values of e , Y_2 , Y_3 , and Y_0 are given in the table below.

Boundary Dimensions (mm)	Basic Load Ratings				Limiting Speeds		Bearing
	C_r	C_{0r}	C_r	C_{0r}	Grease	Oil	
d D B $r_{min.}$	(N)	(kgf)	(min ⁻¹)	Cylindrical Bore			
280	380 75 2.1	925 000 1 950 000	94 500 199 000	800 950	23956CAE4		
	420 106 4	1 540 000 2 950 000	157 000 300 000	710 900	23056CAE4		
	420 140 4	1 880 000 3 800 000	191 000 385 000	600 800	24056CAE4		
	460 146 5	2 230 000 4 000 000	228 000 410 000	560 750	23156CAE4		
	460 180 5	2 640 000 5 000 000	269 000 505 000	560 750	24156CAE4		
	500 130 5	2 280 000 3 650 000	233 000 370 000	630 800	22256CAE4		
	500 176 5	2 880 000 4 900 000	294 000 500 000	530 670	23256CAE4		
	580 175 6	3 500 000 5 150 000	355 000 525 000	560 710	22356CAE4		
300	420 90 3	1 230 000 2 490 000	125 000 254 000	710 900	23960CAE4		
	460 118 4	1 920 000 3 700 000	196 000 375 000	670 850	23060CAE4		
	460 160 4	2 310 000 4 600 000	235 000 470 000	530 710	24060CAE4		
	500 160 5	2 670 000 4 800 000	273 000 490 000	500 670	23160CAE4		
	500 200 5	3 100 000 5 800 000	315 000 595 000	500 670	24160CAE4		
	540 140 5	2 610 000 4 250 000	266 000 430 000	600 750	22260CAE4		
	540 192 5	3 400 000 5 900 000	350 000 600 000	480 630	23260CAE4		
320	440 90 3	1 300 000 2 750 000	132 000 281 000	670 850	23964CAE4		
	480 121 4	1 960 000 3 850 000	200 000 395 000	630 800	23064CAE4		
	480 160 4	2 440 000 5 050 000	249 000 515 000	500 670	24064CAE4		
	540 176 5	3 050 000 5 500 000	315 000 560 000	480 600	23164CAE4		
	540 218 5	3 550 000 6 650 000	360 000 675 000	480 600	24164CAE4		
	580 150 5	2 990 000 4 850 000	305 000 495 000	530 670	22264CAE4		
	580 208 5	3 900 000 6 900 000	395 000 700 000	450 600	23264CAE4		
340	460 90 3	1 330 000 2 840 000	136 000 289 000	630 800	23968CAE4		
	520 133 5	2 280 000 4 400 000	232 000 445 000	560 710	23068CAE4		
	520 180 5	2 920 000 6 050 000	298 000 615 000	480 600	24068CAE4		
	580 190 5	3 600 000 6 600 000	370 000 670 000	430 560	23168CAE4		
	580 243 5	4 250 000 7 900 000	430 000 810 000	430 560	24168CAE4		
	620 224 6	4 400 000 7 800 000	450 000 795 000	400 530	23268CAE4		

Note (1) The suffix K or K30 represents bearings with tapered bores (taper 1 : 12 or 1 : 30).

Numbers	Abutment and Fillet Dimensions (mm)				Constant	Axial Load Factors			Mass (kg)
	d_a min.	d_a max.	D_a min.	r_a max.		e	Y_2	Y_3	
Tapered Bore(1)									approx.
23956CAKE4	292	368	351	2	0.18	5.7	3.9	3.8	24.5
23056CAKE4	298	402	377	3	0.24	4.2	2.8	2.7	50.5
24056CAK30E4	298	402	369	3	0.31	3.3	2.2	2.2	66.4
23156CAKE4	302	438	400	4	0.30	3.3	2.2	2.2	94.3
24156CAK30E4	302	438	392	4	0.37	2.7	1.8	1.8	115
22256CAKE4	302	478	439	4	0.25	4.0	2.7	2.6	110
23256CAKE4	302	478	425	4	0.35	2.9	1.9	1.9	147
22356CAKE4	308	552	496	5	0.31	3.2	2.1	2.1	221
23960CAKE4	314	406	386	2.5	0.19	5.2	3.5	3.4	38.2
23060CAKE4	318	442	413	3	0.24	4.2	2.8	2.7	70.5
24060CAK30E4	318	442	400	3	0.32	3.1	2.1	2.0	93.6
23160CAKE4	322	478	433	4	0.31	3.3	2.2	2.2	125
24160CAK30E4	322	478	423	4	0.38	2.6	1.8	1.7	152
22260CAKE4	322	518	473	4	0.25	4.0	2.7	2.6	139
23260CAKE4	322	518	458	4	0.35	2.9	1.9	1.9	189
23964CAKE4	334	426	406	2.5	0.18	5.5	3.7	3.6	40.6
23064CAKE4	338	462	432	3	0.24	4.2	2.8	2.8	75.6
24064CAK30E4	338	462	422	3	0.31	3.3	2.2	2.2	99.7
23164CAKE4	342	518	466	4	0.31	3.2	2.1	2.1	162
24164CAK30E4	342	518	456	4	0.39	2.6	1.7	1.7	196
22264CAKE4	342	558	508	4	0.26	3.9	2.6	2.6	174
23264CAKE4	342	558	488	4	0.36	2.8	1.9	1.8	239
23968CAKE4	354	446	427	2.5	0.18	5.7	3.8	3.7	42.4
23068CAKE4	362	498	465	4	0.24	4.2	2.8	2.8	101
24068CAK30E4	362	498	454	4	0.32	3.2	2.1	2.1	135
23168CAKE4	362	558	499	4	0.31	3.2	2.1	2.1	206
24168CAK30E4	362	558	489	4	0.40	2.5	1.7	1.7	257
23268CAKE4	368	592	521	5	0.36	2.8	1.9	1.8	295

Remarks For the dimensions of adapters and withdrawal sleeves, refer to Pages B363 – B364, and B369 – B370.

Bore Diameter 360 – 440 mm

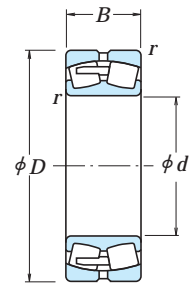

Cylindrical Bore

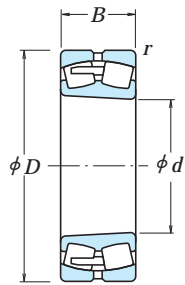

Tapered Bore



Without an Oil Groove and Holes

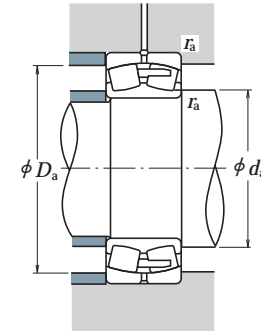

Dynamic Equivalent Load

$$P = XF_r + YF_a$$

$F_a / F_r \leq e$		$F_a / F_r > e$	
X	Y	X	Y
1	Y_3	0.67	Y_2

Static Equivalent Load

$$P_0 = F_r + Y_0 F_a$$

The values of e , Y_2 , Y_3 , and Y_0 are given in the table below.

Boundary Dimensions (mm)	Basic Load Ratings				Limiting Speeds		Bearing			
	d	D	B	$r_{min.}$	(N)	(kgf)		(min ⁻¹)		
				C_r	C_{0r}	C_r	C_{0r}	Grease	Oil	Cylindrical Bore
360	480	90	3	1 390 000	3 050 000	142 000	315 000	600	750	23972CAE4
	540	134	5	2 390 000	4 700 000	244 000	480 000	530	670	23072CAE4
	540	180	5	2 930 000	6 100 000	299 000	625 000	450	600	24072CAE4
	600	192	5	3 800 000	7 100 000	390 000	725 000	400	530	23172CAE4
	600	243	5	4 200 000	8 000 000	430 000	815 000	400	530	24172CAE4
	650	232	6	4 800 000	8 550 000	490 000	870 000	380	500	23272CAE4
380	520	106	4	1 870 000	4 100 000	190 000	420 000	530	670	23976CAE4
	560	135	5	2 500 000	5 100 000	255 000	520 000	530	630	23076CAE4
	560	180	5	3 050 000	6 600 000	315 000	670 000	430	560	24076CAE4
	620	194	5	4 000 000	7 600 000	405 000	775 000	400	500	23176CAE4
	620	243	5	4 350 000	8 450 000	440 000	865 000	400	500	24176CAE4
	680	240	6	5 150 000	9 200 000	525 000	940 000	360	480	23276CAE4
400	540	106	4	1 890 000	4 250 000	193 000	435 000	530	630	23980CAE4
	600	148	5	2 970 000	5 900 000	305 000	605 000	480	600	23080CAE4
	600	200	5	3 600 000	7 600 000	370 000	775 000	400	500	24080CAE4
	650	200	6	4 150 000	7 900 000	420 000	805 000	380	480	23180CAE4
	650	250	6	4 950 000	10 100 000	505 000	1 030 000	380	480	24180CAE4
	720	256	6	5 800 000	10 400 000	590 000	1 060 000	340	450	23280CAE4
420	560	106	4	1 870 000	4 250 000	191 000	430 000	500	600	23984CAE4
	620	150	5	2 910 000	5 850 000	297 000	595 000	450	560	23084CAE4
	620	200	5	3 750 000	8 100 000	380 000	825 000	380	480	24084CAE4
	700	224	6	5 000 000	9 400 000	510 000	960 000	340	450	23184CAE4
	700	280	6	6 000 000	12 000 000	610 000	1 220 000	340	450	24184CAE4
	760	272	7.5	6 450 000	11 700 000	660 000	1 190 000	320	430	23284CAE4
440	600	118	4	2 190 000	4 800 000	223 000	490 000	450	560	23988CAE4
	650	157	6	3 150 000	6 350 000	320 000	645 000	430	530	23088CAE4
	650	212	6	4 150 000	9 100 000	425 000	930 000	360	450	24088CAE4
	720	226	6	5 300 000	10 300 000	540 000	1 060 000	320	430	23188CAE4
	720	280	6	6 000 000	12 100 000	610 000	1 230 000	320	430	24188CAE4
	790	280	7.5	6 900 000	12 800 000	705 000	1 300 000	300	400	23288CAE4

Note (1) The suffix K or K30 represents bearings with tapered bores (taper 1 : 12 or 1 : 30).

Numbers	Abutment and Fillet Dimensions (mm)				Constant	Axial Load Factors			Mass (kg)
	d_a min.	d_a max.	D_a min.	r_a max.		e	Y_2	Y_3	
Tapered Bore⁽¹⁾									approx.
23972CAKE4	374	466	447	2.5	0.17	6.0	4.1	4.0	44.7
23072CAKE4	382	518	485	4	0.24	4.2	2.8	2.8	106
24072CAK30E4	382	518	476	4	0.32	3.2	2.1	2.1	139
23172CAKE4	382	578	520	4	0.31	3.2	2.2	2.1	217
24172CAK30E4	382	578	507	4	0.40	2.5	1.7	1.7	264
23272CAKE4	388	622	549	5	0.36	2.8	1.9	1.8	342
23976CAKE4	398	502	482	3	0.18	5.5	3.7	3.6	65.4
23076CAKE4	402	538	506	4	0.22	4.5	3.0	3.0	113
24076CAK30E4	402	538	496	4	0.29	3.4	2.3	2.3	148
23176CAKE4	402	598	540	4	0.30	3.3	2.2	2.2	229
24176CAK30E4	402	598	529	4	0.38	2.6	1.8	1.7	275
23276CAKE4	408	652	578	5	0.35	2.9	1.9	1.9	372
23980CAKE4	418	522	501	3	0.18	5.7	3.9	3.8	69.1
23080CAKE4	422	578	540	4	0.23	4.4	3.0	2.9	146
24080CAK30E4	422	578	527	4	0.31	3.3	2.2	2.2	193
23180CAKE4	428	622	569	5	0.29	3.4	2.3	2.3	257
24180CAK30E4	428	622	551	5	0.37	2.7	1.8	1.8	316
23280CAKE4	428	692	610	5	0.36	2.8	1.9	1.9	449
23984CAKE4	438	542	521	3	0.17	6.0	4.0	3.9	71.6
23084CAKE4	442	598	562	4	0.23	4.3	2.9	2.8	151
24084CAK30E4	442	598	549	4	0.31	3.2	2.2	2.1	199
23184CAKE4	448	672	607	5	0.31	3.3	2.2	2.2	341
24184CAK30E4	448	672	598	5	0.38	2.6	1.8	1.7	421
23284CAKE4	456	724	644	6	0.35	2.9	1.9	1.9	534
23988CAKE4	458	582	555	3	0.18	5.7	3.9	3.8	96.3
23088CAKE4	468	622	587	5	0.23	4.3	2.9	2.8	173
24088CAK30E4	468	622	576	5	0.31	3.2	2.1	2.1	237
23188CAKE4	468	692	627	5	0.3	3.3	2.2	2.2	360
24188CAK30E4	468	692	617	5	0.37	2.7	1.8	1.8	433
23288CAKE4	476	754	669	6	0.35	2.9	1.9	1.9	594

Remarks For the dimensions of adapters and withdrawal sleeves, refer to Pages B364, and B370 – B371.

Bore Diameter 460 – 560 mm

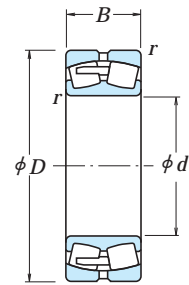

Cylindrical Bore

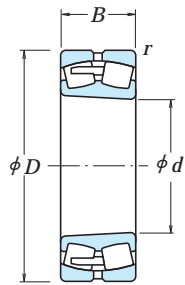

Tapered Bore



Without an Oil Groove and Holes

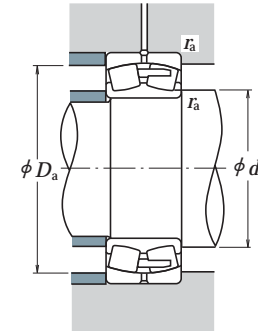

Dynamic Equivalent Load

$$P = XF_r + YF_a$$

$F_a / F_r \leq e$		$F_a / F_r > e$	
X	Y	X	Y
1	Y_3	0.67	Y_2

Static Equivalent Load

$$P_0 = F_r + Y_0 F_a$$

The values of e , Y_2 , Y_3 , and Y_0 are given in the table below.

Boundary Dimensions (mm)	Basic Load Ratings				Limiting Speeds		Bearing			
	d	D	B	$r_{min.}$	(N)	{kgf}		(min^{-1})		
				C_r	C_{0r}	C_r	C_{0r}	Grease	Oil	Cylindrical Bore
460	620	118	4	2 220 000	4 950 000	227 000	505 000	430	530	23992CAE4
	680	163	6	3 450 000	7 100 000	355 000	725 000	400	500	23092CAE4
	680	218	6	4 500 000	9 950 000	460 000	1 010 000	340	430	24092CAE4
480	760	240	7.5	5 700 000	10 900 000	580 000	1 110 000	300	400	23192CAE4
	760	300	7.5	6 300 000	12 400 000	640 000	1 270 000	300	400	24192CAE4
	830	296	7.5	7 350 000	13 700 000	750 000	1 400 000	280	380	23292CAE4
500	650	128	5	2 580 000	5 850 000	263 000	595 000	400	500	23996CAE4
	700	165	6	3 800 000	7 950 000	385 000	810 000	400	480	23096CAE4
	700	218	6	4 600 000	10 200 000	470 000	1 040 000	320	430	24096CAE4
530	790	248	7.5	6 050 000	11 700 000	620 000	1 200 000	300	380	23196CAE4
	790	308	7.5	7 150 000	14 600 000	730 000	1 490 000	300	380	24196CAE4
	870	310	7.5	7 850 000	14 400 000	805 000	1 470 000	260	360	23296CAE4
560	670	128	5	2 460 000	5 550 000	250 000	565 000	400	500	239/500CAE4
	720	167	6	3 750 000	8 100 000	385 000	825 000	380	480	230/500CAE4
	720	218	6	4 450 000	9 900 000	450 000	1 010 000	300	400	240/500CAE4
530	830	264	7.5	6 850 000	13 400 000	700 000	1 360 000	280	360	231/500CAE4
	830	325	7.5	8 000 000	16 000 000	815 000	1 630 000	280	360	241/500CAE4
	920	336	7.5	9 000 000	16 600 000	915 000	1 690 000	260	320	232/500CAE4
530	710	136	5	2 930 000	6 800 000	299 000	695 000	360	450	239/530CAE4
	780	185	6	4 400 000	9 200 000	450 000	940 000	340	430	230/530CAE4
	780	250	6	5 400 000	11 800 000	550 000	1 210 000	280	360	240/530CAE4
560	870	272	7.5	7 150 000	14 100 000	730 000	1 440 000	260	340	231/530CAE4
	870	335	7.5	8 500 000	17 500 000	870 000	1 790 000	260	340	241/530CAE4
	980	355	9.5	10 100 000	18 800 000	1 030 000	1 920 000	240	300	232/530CAE4
560	750	140	5	3 100 000	7 250 000	320 000	740 000	340	430	239/560CAE4
	820	195	6	5 000 000	10 700 000	510 000	1 090 000	320	400	230/560CAE4
	820	258	6	5 950 000	13 300 000	605 000	1 360 000	260	340	240/560CAE4
560	920	280	7.5	7 850 000	15 500 000	800 000	1 580 000	240	320	231/560CAE4
	920	355	7.5	9 400 000	19 600 000	960 000	2 000 000	240	320	241/560CAE4
	1 030	365	9.5	10 900 000	20 500 000	1 110 000	2 090 000	220	280	232/560CAE4

Note (1) The suffix K or K30 represents bearings with tapered bores (taper 1 : 12 or 1 : 30).

Numbers	Abutment and Fillet Dimensions (mm)				Constant	Axial Load Factors			Mass (kg)
	d_a min.	d_a max.	D_a min.	r_a max.		e	Y_2	Y_3	
Tapered Bore(1)									approx.
23992CAKE4	478	602	575	3	0.17	5.9	4.0	3.9	100
23092CAKE4	488	652	615	5	0.22	4.6	3.1	3.0	201
24092CAK30E4	488	652	604	5	0.29	3.4	2.3	2.3	266
23192CAKE4	496	724	661	6	0.31	3.3	2.2	2.2	423
24192CAK30E4	496	724	646	6	0.39	2.6	1.7	1.7	512
23292CAKE4	496	794	702	6	0.36	2.8	1.9	1.8	691
23996CAKE4	502	628	602	4	0.18	5.7	3.8	3.7	121
23096CAKE4	508	672	633	5	0.22	4.6	3.1	3.0	211
24096CAK30E4	508	672	625	5	0.30	3.4	2.3	2.2	270
23196CAKE4	516	754	688	6	0.31	3.3	2.2	2.2	475
24196CAK30E4	516	754	670	6	0.39	2.6	1.7	1.7	567
23296CAKE4	516	834	733	6	0.36	2.8	1.9	1.8	795
239/500CAKE4	522	648	622	4	0.17	6.0	4.0	3.9	124
230/500CAKE4	528	692	655	5	0.21	4.8	3.2	3.1	220
240/500CAK30E4	528	692	643	5	0.30	3.4	2.3	2.2	276
231/500CAKE4	536	794	720	6	0.31	3.2	2.2	2.1	567
241/500CAK30E4	536	794	703	6	0.39	2.6	1.7	1.7	666
232/500CAKE4	536	884	773	6	0.38	2.7	1.8	1.8	969
239/530CAKE4	552	688	659	4	0.17	6.0	4.0	3.9	149
230/530CAKE4	558	752	706	5	0.22	4.6	3.1	3.0	298
240/530CAK30E4	558	752	690	5	0.31	3.3	2.2	2.2	390
231/530CAKE4	566	834	758	6	0.30	3.3	2.2	2.2	628
241/530CAK30E4	566	834	740	6	0.38	2.6	1.8	1.7	773
232/530CAKE4	574	936	824	8	0.38	2.7	1.8	1.7	1 170
239/560CAKE4	582	728	697	4	0.16	6.1	4.1	4.0	172
230/560CAKE4	588	792	742	5	0.22	4.5	3.0	2.9	344
240/560CAK30E4	588	792	729	5	0.30	3.3	2.2	2.2	440
231/560CAKE4	596	884	804	6	0.30	3.4	2.3	2.2	727
241/560CAK30E4	596	884	782	6	0.39	2.6	1.8	1.7	886
232/560CAKE4	604	986	870	8	0.36	2.8	1.9	1.8	1 320

Remarks For the dimensions of adapters and withdrawal sleeves, refer to Pages B365 and B371.

Bore Diameter 600 – 800 mm

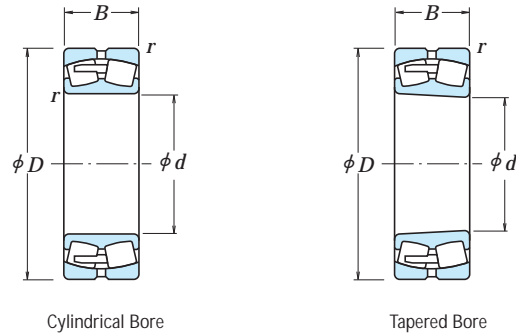

Cylindrical Bore

Tapered Bore

Dynamic Equivalent Load

$$P = XF_r + YF_a$$

$F_a / F_r \leq e$		$F_a / F_r > e$	
X	Y	X	Y
1	Y_3	0.67	Y_2

Static Equivalent Load

$$P_0 = F_r + Y_0 F_a$$

The values of e , Y_2 , Y_3 , and Y_0 are given in the table below.

Boundary Dimensions (mm)				Basic Load Ratings				Limiting Speeds		Bearing
d	D	B	r min.	(N)		(kgf)		Grease	Oil	
600	800	150	5	3 450 000	8 100 000	350 000	830 000	320	400	239/600CAE4
	870	200	6	5 450 000	12 200 000	555 000	1 240 000	300	360	230/600CAE4
	870	272	6	6 600 000	15 100 000	675 000	1 540 000	240	320	240/600CAE4
	980	300	7.5	8 750 000	17 500 000	895 000	1 790 000	220	280	231/600CAE4
	980	375	7.5	10 400 000	21 900 000	1 060 000	2 230 000	220	280	241/600CAE4
1 090	388	9.5	12 700 000	24 900 000	1 300 000	2 540 000	200	260	232/600CAE4	
630	850	165	6	4 000 000	9 350 000	405 000	950 000	300	360	239/630CAE4
	920	212	7.5	5 900 000	12 700 000	600 000	1 300 000	280	340	230/630CAE4
	920	290	7.5	7 550 000	17 700 000	770 000	1 810 000	220	300	240/630CAE4
	1 030	315	7.5	9 600 000	19 400 000	980 000	1 970 000	200	260	231/630CAE4
	1 030	400	7.5	11 300 000	23 900 000	1 160 000	2 440 000	200	260	241/630CAE4
1 150	412	12	13 400 000	25 600 000	1 370 000	2 610 000	180	240	232/630CAE4	
670	900	170	6	4 350 000	10 300 000	445 000	1 050 000	260	340	239/670CAE4
	980	230	7.5	6 850 000	15 000 000	700 000	1 530 000	240	320	230/670CAE4
	980	308	7.5	8 450 000	19 500 000	860 000	1 990 000	200	260	240/670CAE4
	1 090	336	7.5	10 600 000	21 600 000	1 080 000	2 200 000	190	240	231/670CAE4
	1 090	412	7.5	12 400 000	26 500 000	1 270 000	2 700 000	190	240	241/670CAE4
1 220	438	12	14 900 000	28 700 000	1 520 000	2 920 000	170	220	232/670CAE4	
710	950	180	6	4 800 000	11 700 000	490 000	1 200 000	240	300	239/710CAE4
	1 030	236	7.5	7 100 000	15 800 000	725 000	1 610 000	240	280	230/710CAE4
	1 030	315	7.5	8 850 000	20 700 000	905 000	2 110 000	190	240	240/710CAE4
	1 150	438	9.5	13 900 000	30 500 000	1 410 000	3 100 000	170	220	241/710CAE4
	1 280	450	12	15 700 000	30 500 000	1 600 000	3 100 000	160	200	232/710CAE4
750	1 000	185	6	5 250 000	12 800 000	535 000	1 310 000	220	280	239/750CAE4
	1 090	250	7.5	7 750 000	17 200 000	790 000	1 750 000	220	260	230/750CAE4
	1 090	335	7.5	10 100 000	24 000 000	1 030 000	2 450 000	180	220	240/750CAE4
	1 360	475	15	17 700 000	35 500 000	1 800 000	3 600 000	140	190	232/750CAE4
	800	1 060	195	6	5 600 000	13 700 000	570 000	1 400 000	220	260
1 150		258	7.5	8 350 000	19 100 000	850 000	1 950 000	200	240	230/800CAE4
1 150		345	7.5	10 900 000	26 300 000	1 110 000	2 680 000	160	200	240/800CAE4
1 280		375	9.5	13 800 000	29 200 000	1 410 000	2 970 000	150	190	231/800CAE4
1 420		488	15	20 300 000	41 000 000	2 070 000	4 150 000	130	170	232/800CAE4

Note (1) The suffix K or K30 represents bearings with tapered bores (taper 1 : 12 or 1 : 30).

Numbers	Abutment and Fillet Dimensions (mm)				Constant	Axial Load Factors			Mass (kg)
	d_a min.	d_a max.	D_a min.	r_a max.		e	Y_2	Y_3	
Tapered Bore(1)									approx.
239/600CAKE4	622	778	745	4	0.17	5.9	3.9	3.9	205
230/600CAKE4	628	842	794	5	0.21	4.8	3.3	3.2	389
240/600CAK30E4	628	842	772	5	0.30	3.3	2.2	2.2	529
231/600CAKE4	636	944	856	6	0.30	3.4	2.3	2.2	898
241/600CAK30E4	636	944	836	6	0.39	2.6	1.8	1.7	1 050
232/600CAKE4	644	1 046	923	8	0.36	2.8	1.9	1.8	1 590
239/630CAKE4	658	822	786	5	0.18	5.6	3.8	3.7	259
230/630CAKE4	666	884	835	6	0.22	4.7	3.1	3.1	468
240/630CAK30E4	666	884	815	6	0.30	3.3	2.2	2.2	637
231/630CAKE4	666	994	900	6	0.30	3.4	2.3	2.2	1 040
241/630CAK30E4	666	994	876	6	0.38	2.7	1.8	1.7	1 250
232/630CAKE4	684	1 096	970	10	0.36	2.8	1.9	1.8	1 850
239/670CAKE4	698	872	836	5	0.17	5.8	3.9	3.8	300
230/670CAKE4	706	944	891	6	0.22	4.7	3.1	3.1	571
240/670CAK30E4	706	944	868	6	0.30	3.3	2.2	2.2	773
231/670CAKE4	706	1 054	952	6	0.30	3.3	2.2	2.2	1 230
241/670CAK30E4	706	1 054	934	6	0.37	2.7	1.8	1.8	1 440
232/670CAKE4	724	1 166	1 024	10	0.37	2.7	1.8	1.8	2 210
239/710CAKE4	738	922	883	5	0.17	5.8	3.9	3.8	352
230/710CAKE4	746	994	936	6	0.22	4.6	3.1	3.0	647
240/710CAK30E4	746	994	916	6	0.29	3.4	2.3	2.2	861
241/710CAK30E4	754	1 106	981	8	0.38	2.6	1.8	1.7	1 730
232/710CAKE4	764	1 226	1 080	10	0.36	2.8	1.9	1.8	2 470
239/750CAKE4	778	972	931	5	0.17	6.0	4.1	4.0	398
230/750CAKE4	786	1 054	990	6	0.22	4.6	3.1	3.0	768
240/750CAK30E4	786	1 054	969	6	0.29	3.4	2.3	2.2	1 030
232/750CAKE4	814	1 296	1 148	12	0.36	2.8	1.9	1.8	2 980
239/800CAKE4	828	1 032	987	5	0.17	6.0	4.0	3.9	462
230/800CAKE4	836	1 114	1 045	6	0.21	4.7	3.2	3.1	870
240/800CAK30E4	836	1 114	1 029	6	0.27	3.7	2.5	2.5	1 130
231/800CAKE4	844	1 236	1 127	8	0.28	3.6	2.4	2.3	1 870
232/800CAKE4	864	1 356	1 208	12	0.35	2.8	1.9	1.9	3 250

Bore Diameter 850 – 1400 mm

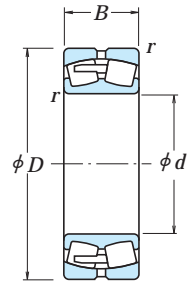

Cylindrical Bore

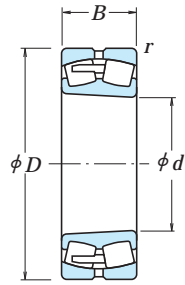

Tapered Bore

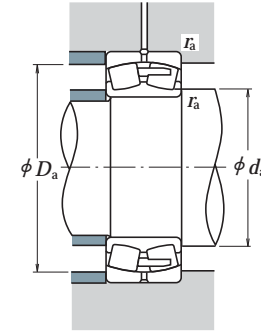

Dynamic Equivalent Load

$$P = XF_r + YF_a$$

$F_a / F_r \leq e$		$F_a / F_r > e$	
X	Y	X	Y
1	Y_3	0.67	Y_2

Static Equivalent Load

$$P_0 = F_r + Y_0 F_a$$

The values of e , Y_2 , Y_3 , and Y_0 are given in the table below.

Boundary Dimensions (mm)	Basic Load Ratings				Limiting Speeds		Bearing			
	C_r	C_{0r}	C_r	C_{0r}	Grease	Oil				
d D B $r_{min.}$	(N)	(kgf)					Cylindrical Bore			
850	1 120 1 220	200 272	6 7.5	6 100 000 9 300 000	15 200 000 21 400 000	620 000 945 000	1 550 000 2 190 000	190 180	240 220	239/850CAE4 230/850CAE4
	1 220 1 500	365 515	7.5 15	11 600 000 22 300 000	28 300 000 45 500 000	1 180 000 2 270 000	2 890 000 4 650 000	150 120	190 160	240/850CAE4 232/850CAE4
900	1 180 1 280	206 280	6 7.5	6 600 000 9 850 000	16 700 000 22 800 000	670 000 1 000 000	1 700 000 2 330 000	180 160	220 200	239/900CAE4 230/900CAE4
	1 280 1 580	375 515	7.5 15	12 800 000 23 400 000	31 500 000 47 500 000	1 300 000 2 380 000	3 250 000 4 850 000	140 110	180 140	240/900CAE4 232/900CAE4
950	1 250 1 360	224 300	7.5 7.5	7 600 000 11 300 000	19 900 000 26 500 000	775 000 1 160 000	2 030 000 2 710 000	160 150	200 190	239/950CAE4 230/950CAE4
	1 360 1 660	412 530	7.5 15	14 500 000 24 700 000	36 500 000 50 500 000	1 480 000 2 520 000	3 700 000 5 150 000	120 100	160 130	240/950CAE4 232/950CAE4
1 000	1 320 1 420 1 420	236 308 412	7.5 7.5 7.5	8 200 000 11 900 000 15 300 000	21 700 000 28 100 000 38 500 000	835 000 1 210 000 1 560 000	2 210 000 2 860 000 3 950 000	150 140 110	190 170 150	239/1000CAE4 230/1000CAE4 240/1000CAE4
1 060	1 400 1 500 1 500	250 325 438	7.5 9.5 9.5	9 300 000 13 000 000 16 800 000	24 400 000 31 500 000 43 000 000	950 000 1 330 000 1 720 000	2 490 000 3 200 000 4 350 000	130 120 100	170 160 130	239/1060CAE4 230/1060CAE4 240/1060CAE4
1 120	1 580 1 580	345 462	9.5 9.5	15 400 000 18 700 000	38 000 000 49 500 000	1 570 000 1 910 000	3 850 000 5 050 000	110 95	140 120	230/1120CAE4 240/1120CAE4
1 180	1 660	475	9.5	20 200 000	52 500 000	2 060 000	5 350 000	85	110	240/1180CAE4
1 250	1 750	500	9.5	21 000 000	59 500 000	2 140 000	6 050 000	75	100	240/1250CAE4
1 320	1 850	530	12	22 600 000	63 500 000	2 310 000	6 500 000	67	85	240/1320CAE4
1 400	1 950	545	12	24 500 000	65 000 000	2 500 000	6 650 000	60	75	240/1400CAE4

Note (!) The suffix K or K30 represents bearings with tapered bores (taper 1 : 12 or 1 : 30).

Numbers	Abutment and Fillet Dimensions (mm)				Constant	Axial Load Factors			Mass (kg)
	d_a min.	d_a max.	D_a min.	r_a max.		e	Y_2	Y_3	
239/850CAKE4 230/850CAKE4	878 886	1 092 1 184	1 046 1 109	5 6	0.16 0.21	6.2 4.8	4.2 3.2	4.1 3.1	523 1 020
240/850CAK30E4 232/850CAKE4	886 914	1 184 1 436	1 093 1 274	6 12	0.28 0.35	3.6 2.8	2.4 1.9	2.4 1.9	1 350 3 890
239/900CAKE4 230/900CAKE4	928 936	1 152 1 244	1 103 1 169	5 6	0.16 0.20	6.4 4.9	4.3 3.3	4.2 3.2	591 1 160
240/900CAK30E4 232/900CAKE4	936 964	1 244 1 516	1 147 1 354	6 12	0.28 0.33	3.6 3.0	2.4 2.0	2.4 2.0	1 520 4 300
239/950CAKE4 230/950CAKE4	986 986	1 214 1 324	1 169 1 241	6 6	0.16 0.21	6.3 4.8	4.2 3.2	4.1 3.2	732 1 400
240/950CAK30E4 232/950CAKE4	986 1 014	1 324 1 596	1 219 1 428	6 12	0.28 0.32	3.6 3.1	2.4 2.1	2.3 2.1	1 880 4 800
239/1000CAKE4 230/1000CAKE4 240/1000CAK30E4	1 036 1 036 1 036	1 284 1 384 1 384	1 229 1 298 1 275	6 6 6	0.16 0.20 0.27	6.4 4.9 3.7	4.3 3.3 2.5	4.2 3.2 2.4	881 1 560 2 010
239/1060CAKE4 230/1060CAKE4 240/1060CAK30E4	1 096 1 104 1 104	1 364 1 456 1 456	1 302 1 368 1 346	6 8 8	0.16 0.21 0.28	6.1 4.9 3.6	4.1 3.3 2.4	4.0 3.2 2.4	1 030 1 790 2 410
230/1120CAKE4 240/1120CAK30E4	1 164 1 164	1 536 1 536	1 444 1 421	8 8	0.20 0.27	5.0 3.7	3.4 2.5	3.3 2.5	2 120 2 790
240/1180CAK30E4	1 224	1 616	1 494	8	0.27	3.7	2.5	2.4	3 180
240/1250CAK30E4	1 294	1 706	1 579	8	0.25	4.0	2.7	2.6	3 700
240/1320CAK30E4	1 374	1 796	1 656	10	0.26	3.9	2.6	2.6	4 400
240/1400CAK30E4	1 454	1 896	1 767	10	0.25	4.0	2.7	2.6	4 900

THRUST BEARINGS

SINGLE-DIRECTION THRUST BALL BEARINGS

With Flat Seat, Aligning Seat, or Aligning Seat Washer	Bore Diameter	10 – 100mm	B210
	Bore Diameter	110 – 360mm	B214

DOUBLE-DIRECTION THRUST BALL BEARINGS

With Flat Seat, Aligning Seat, or Aligning Seat Washer	Bore Diameter	10 – 190mm	B218
--	---------------	------------	-------	------

THRUST CYLINDRICAL ROLLER BEARINGS	Bore Diameter	35 – 320mm	B224
---	---------------	------------	-------	------

THRUST SPHERICAL ROLLER BEARINGS	Bore Diameter	60 – 500mm	B228
---	---------------	------------	-------	------

Angular Contact Thrust Ball Bearings are described on pages B234 to B243.



DESIGN, TYPES, AND FEATURES

THRUST BALL BEARINGS

Thrust ball bearings are classified into those with flat seats or aligning seats depending on the shape of the outer ring seat (housing washer). They can sustain axial loads but no radial loads.

The series of thrust ball bearings available are shown in Table 1. For Single-Direction Thrust Ball Bearings, pressed steel cages and machined brass cages are usually used as shown in Table 2. The cages in Double-Direction Thrust Ball Bearings are the same as those in Single-Direction Thrust Ball Bearings of the same diameter series.

The basic load ratings listed in the bearing tables are based on the standard cage type shown in Table 2. If the type of cage is different for bearings with the same number, the number of balls may vary, in such a case, the load rating will differ from the one listed in the bearing tables.

Table 1 Series of Thrust Ball Bearings

	W/Flat Seat	W/Aligning Seat	W/Aligning Seat Washer
Single-Direction	511	—	—
	512	532	532U
	513	533	533U
	514	534	534U
Double-Direction	522	542	542U
	523	543	543U
	524	544	544U

Table 2 Standard Cages for Thrust Ball Bearings

Pressed Steel	Machined Brass
51100 – 51152X 51200 – 51236X 51305 – 51336X	51156X – 51172X 51238X – 51272X 51338X – 51340X
51405 – 51418X 53200 – 53236X 53305 – 53336X 53405 – 53418X	51420X – 51436X 53238X – 53272X 53338X – 53340X 53420X – 53436X

THRUST CYLINDRICAL ROLLER BEARINGS

These are thrust bearings containing cylindrical rollers. They can sustain only axial loads, but they are suitable for heavy loads and have high axial rigidity.

The cages are machined brass.

THRUST SPHERICAL ROLLER BEARINGS

These are thrust bearings containing convex rollers. They have a self-aligning capability and are free of any influence of mounting error or shaft deflection. Besides the original type, the E type with pressed cages for high load capacity is also available. Their bearing numbers are suffixed by E.

For horizontal shaft or high speed application, machined brass cages are recommended. For details, contact NSK.

Since there are several places where lubrication is difficult, such as the area between the roller heads and inner ring rib, the sliding surfaces between cage and guide sleeve, etc., oil lubrication should be used even at low speed.

The cages in the original type are machined brass.

TOLERANCES AND RUNNING ACCURACY

THRUST BALL BEARINGS Table 8.6 (Pages A72 to A74)

THRUST CYLINDRICAL ROLLER BEARINGS
.....According to Table 8.2 (Pages A72 to A74)

THRUST SPHERICAL ROLLER BEARINGS Table 8.7 (Pages A75)

RECOMMENDED FITS

THRUST BALL BEARINGS Table 9.3 (Pages A84)
Table 9.5 (Pages A85)

THRUST CYLINDRICAL ROLLER BEARINGS Table 9.3 (Pages A84)
Table 9.5 (Pages A85)

THRUST SPHERICAL ROLLER BEARINGS Table 9.3 (Pages A84)
Table 9.5 (Pages A85)

DIMENSIONS RELATED TO MOUNTING

The dimensions related to mounting of thrust spherical roller bearings are listed in the Bearing Table.

If the bearing load is heavy, it is necessary to design the shaft shoulder with ample strength in order to provide sufficient support for the shaft washer.

PERMISSIBLE MISALIGNMENT

The permissible misalignment of thrust spherical roller bearings varies depending on the size, but it is approximately 0.018 to 0.036 radian (1° to 2°) with average loads.

MINIMUM AXIAL LOAD

It is necessary to apply some axial load to thrust bearings to prevent slippage between the rolling elements and raceways. For more details, please refer to Page A99.

Bore Diameter 10 – 50 mm

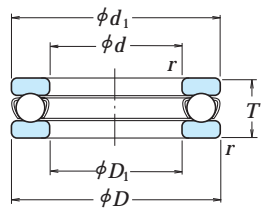

With Flat Seat

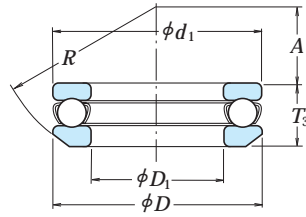

With Aligning Seat

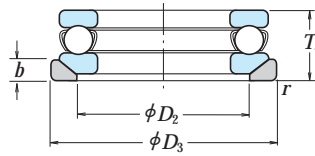

With Aligning Seat Washer

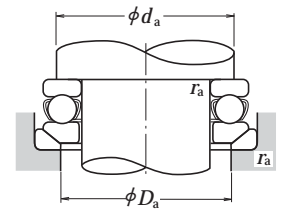
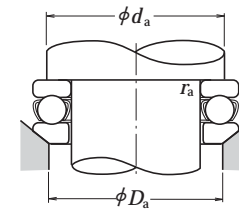
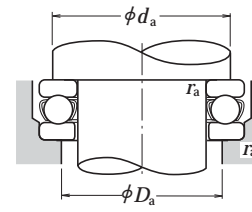

Boundary Dimensions (mm)						Basic Load Ratings (N)				Limiting Speeds (min ⁻¹)		With Flat Seat
<i>d</i>	<i>D</i>	<i>T</i>	<i>T</i> ₃	<i>T</i> ₄	<i>r</i> min.	<i>C</i> _a	<i>C</i> _{0a}	<i>C</i> _a	<i>C</i> _{0a}	Grease	Oil	
10	24	9	—	—	0.3	10 100	14 000	1 030	1 420	6 700	10 000	51100
	26	11	11.6	13	0.6	12 800	17 100	1 300	1 740	6 000	9 000	51200
12	26	9	—	—	0.3	10 400	15 400	1 060	1 570	6 700	10 000	51101
	28	11	11.4	13	0.6	13 300	19 000	1 350	1 940	5 600	8 500	51201
15	28	9	—	—	0.3	10 600	16 800	1 080	1 710	6 300	9 500	51102
	32	12	13.3	15	0.6	16 700	24 800	1 710	2 530	5 000	7 500	51202
17	30	9	—	—	0.3	11 400	19 500	1 170	1 990	6 000	9 000	51103
	35	12	13.2	15	0.6	17 300	27 300	1 760	2 780	4 800	7 500	51203
20	35	10	—	—	0.3	15 100	26 600	1 540	2 710	5 300	8 000	51104
	40	14	14.7	17	0.6	22 500	37 500	2 290	3 850	4 300	6 300	51204
25	42	11	—	—	0.6	19 700	37 000	2 010	3 800	4 800	7 100	51105
	47	15	16.7	19	0.6	28 000	50 500	2 860	5 150	3 800	5 600	51205
	52	18	19.8	22	1	36 000	61 500	3 650	6 250	3 200	5 000	51305
	60	24	26.4	29	1	56 000	89 500	5 700	9 100	2 600	4 000	51405
30	47	11	—	—	0.6	20 600	42 000	2 100	4 300	4 300	6 700	51106
	52	16	17.8	20	0.6	29 500	58 000	3 000	5 950	3 400	5 300	51206
	60	21	22.6	25	1	43 000	78 500	4 400	8 000	2 800	4 300	51306
	70	28	30.1	33	1	73 000	126 000	7 450	12 800	2 200	3 400	51406
35	52	12	—	—	0.6	22 100	49 500	2 250	5 050	4 000	6 000	51107
	62	18	19.9	22	1	39 500	78 000	4 050	7 950	3 000	4 500	51207
	68	24	25.6	28	1	56 000	105 000	5 700	10 700	2 400	3 800	51307
80	32	34	37	1.1	87 500	155 000	8 950	15 800	2 000	3 000	51407	
40	60	13	—	—	0.6	27 100	63 000	2 770	6 400	3 600	5 300	51108
	68	19	20.3	23	1	47 500	98 500	4 850	10 000	2 800	4 300	51208
	78	26	28.5	31	1	70 000	135 000	7 100	13 700	2 200	3 400	51308
	90	36	38.2	42	1.1	103 000	188 000	10 500	19 100	1 700	2 600	51408
45	65	14	—	—	0.6	28 100	69 000	2 860	7 050	3 400	5 000	51109
	73	20	21.3	24	1	48 000	105 000	4 900	10 700	2 600	4 000	51209
	85	28	30.1	33	1	80 500	163 000	8 200	16 700	2 000	3 000	51309
	100	39	42.4	46	1.1	128 000	246 000	13 000	25 100	1 600	2 400	51409
50	70	14	—	—	0.6	29 000	75 500	2 960	7 700	3 200	4 800	51110
	78	22	23.5	26	1	49 000	111 000	5 000	11 400	2 400	3 600	51210
	95	31	34.3	37	1.1	97 500	202 000	9 950	20 600	1 800	2 800	51310
	110	43	45.6	50	1.5	147 000	288 000	15 000	29 400	1 400	2 200	51410

Bearing Numbers		Dimensions (mm)							Abutment and Fillet Dimensions (mm)			Mass(kg) approx.		
With Aligning Seat	With Aligning Seat Washer	<i>d</i> ₁	<i>D</i> ₁	<i>D</i> ₂	<i>D</i> ₃	<i>b</i>	<i>A</i>	<i>R</i>	<i>d</i> _a min.	<i>D</i> _a max.	<i>r</i> _a max.	With Flat Seat	With Aligning Seat	With Aligning Seat Washer
—	—	24	11	—	—	—	—	—	18	16	0.3	0.019	—	—
53200	53200 U	26	12	18	28	3.5	8.5	22	20	16	0.6	0.028	0.029	0.036
—	—	26	13	—	—	—	—	—	20	18	0.3	0.021	—	—
53201	53201 U	28	14	20	30	3.5	11.5	25	22	18	0.6	0.031	0.031	0.039
—	—	28	16	—	—	—	—	—	23	20	0.3	0.023	—	—
53202	53202 U	32	17	24	35	4	12	28	25	22	0.6	0.043	0.048	0.059
—	—	30	18	—	—	—	—	—	25	22	0.3	0.025	—	—
53203	53203 U	35	19	26	38	4	16	32	28	24	0.6	0.050	0.055	0.069
—	—	35	21	—	—	—	—	—	29	26	0.3	0.037	—	—
53204	53204 U	40	22	30	42	5	18	36	32	28	0.6	0.077	0.080	0.096
—	—	42	26	—	—	—	—	—	35	32	0.6	0.056	—	—
53205	53205 U	47	27	36	50	5.5	19	40	38	34	0.6	0.111	0.123	0.151
53305	53305 U	52	27	38	55	6	21	45	41	36	1	0.169	0.182	0.224
53405	53405 U	60	27	42	62	8	19	50	46	39	1	0.334	0.353	0.426
—	—	47	32	—	—	—	—	—	40	37	0.6	0.064	—	—
53206	53206 U	52	32	42	55	5.5	22	45	43	39	0.6	0.137	0.154	0.183
53306	53306 U	60	32	45	62	7	22	50	48	42	1	0.267	0.28	0.336
53406	53406 U	70	32	50	75	9	20	56	54	46	1	0.519	0.535	0.666
—	—	52	37	—	—	—	—	—	45	42	0.6	0.081	—	—
53207	53207 U	62	37	48	65	7	24	50	51	46	1	0.21	0.231	0.292
53307	53307 U	68	37	52	72	7.5	24	56	55	48	1	0.386	0.403	0.488
53407	53407 U	80	37	58	85	10	23	64	62	53	1	0.769	0.785	0.967
—	—	60	42	—	—	—	—	—	52	48	0.6	0.12	—	—
53208	53208 U	68	42	55	72	7	28.5	56	57	51	1	0.27	0.289	0.355
53308	53308 U	78	42	60	82	8.5	28	64	63	55	1	0.536	0.581	0.704
53408	53408 U	90	42	65	95	12	26	72	70	60	1	1.1	1.12	1.38
—	—	65	47	—	—	—	—	—	57	53	0.6	0.143	—	—
53209	53209 U	73	47	60	78	7.5	26	56	62	56	1	0.31	0.333	0.419
53309	53309 U	85	47	65	90	10	25	64	69	61	1	0.672	0.702	0.888
53409	53409 U	100	47	72	105	12.5	29	80	78	67	1	1.46	1.53	1.87
—	—	70	52	—	—	—	—	—	62	58	0.6	0.153	—	—
53210	53210 U	78	52	62	82	7.5	32.5	64	67	61	1	0.378	0.404	0.504
53310	53310 U	95	52	72	100	11	28	72	77	68	1	0.931	1.01	1.27
53410	53410 U	110	52	80	115	14	35	90	86	74	1.5	1.94	1.98	2.41

Bore Diameter 55 – 100 mm

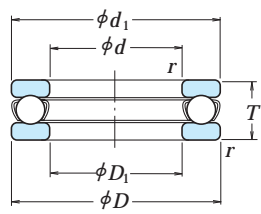

With Flat Seat

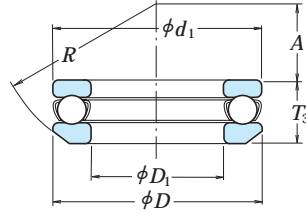

With Aligning Seat

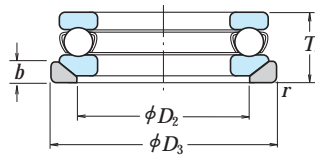

With Aligning Seat Washer

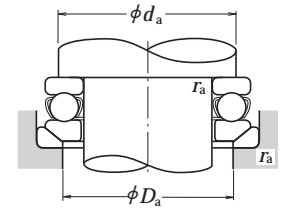
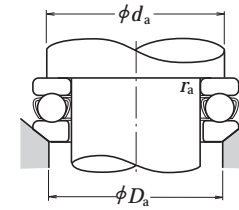
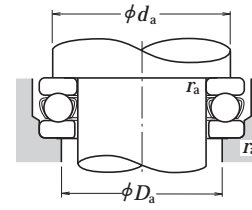

Boundary Dimensions (mm)						Basic Load Ratings (N)				Limiting Speeds (min ⁻¹)		With Flat Seat
<i>d</i>	<i>D</i>	<i>T</i>	<i>T</i> ₃	<i>T</i> ₄	<i>r</i> _{min.}	<i>C</i> _a	<i>C</i> _{0a}	<i>C</i> _a	<i>C</i> _{0a}	Grease	Oil	
55	78	16	—	—	0.6	35 000	93 000	3 600	9 500	2 800	4 300	51111
	90	25	27.3	30	1	70 000	159 000	7 150	16 200	2 200	3 200	51211
	105	35	39.3	42	1.1	115 000	244 000	11 800	24 900	1 600	2 400	51311
	120	48	50.5	55	1.5	181 000	350 000	18 500	35 500	1 300	1 900	51411
60	85	17	—	—	1	41 500	113 000	4 250	11 500	2 600	4 000	51112
	95	26	28	31	1	71 500	169 000	7 300	17 200	2 000	3 000	51212
	110	35	38.3	42	1.1	119 000	263 000	12 100	26 800	1 600	2 400	51312
	130	51	54	58	1.5	202 000	395 000	20 600	40 500	1 200	1 800	51412
65	90	18	—	—	1	42 000	117 000	4 300	12 000	2 400	3 800	51113
	100	27	28.7	32	1	75 500	189 000	7 700	19 200	1 900	2 800	51213
	115	36	39.4	43	1.1	123 000	282 000	12 500	28 700	1 500	2 400	51313
	140	56	60.2	65	2	234 000	495 000	23 800	50 500	1 100	1 700	51413
70	95	18	—	—	1	43 500	127 000	4 450	12 900	2 400	3 600	51114
	105	27	28.8	32	1	74 000	189 000	7 550	19 200	1 900	2 800	51214
	125	40	44.2	48	1.1	137 000	315 000	14 000	32 000	1 400	2 000	51314
	150	60	63.6	69	2	252 000	555 000	25 700	56 500	1 000	1 500	51414
75	100	19	—	—	1	43 500	131 000	4 450	13 400	2 200	3 400	51115
	110	27	28.3	32	1	78 000	209 000	7 950	21 300	1 800	2 800	51215
	135	44	48.1	52	1.5	159 000	365 000	16 200	37 500	1 300	1 900	51315
	160	65	69	75	2	254 000	560 000	25 900	57 000	950	1 400	51415
80	105	19	—	—	1	45 000	141 000	4 600	14 400	2 200	3 400	51116
	115	28	29.5	33	1	79 000	218 000	8 050	22 300	1 800	2 600	51216
	140	44	47.6	52	1.5	164 000	395 000	16 700	40 000	1 300	1 900	51316
	170	68	72.2	78	2.1	272 000	620 000	27 800	63 500	900	1 300	51416
85	110	19	—	—	1	46 500	150 000	4 700	15 300	2 200	3 200	51117
	125	31	33.1	37	1	96 000	264 000	9 800	26 900	1 600	2 400	51217
	150	49	53.1	58	1.5	207 000	490 000	21 100	50 000	1 100	1 700	51317
	180	72	77	83	2.1	310 000	755 000	31 500	77 000	850	1 300	51417 X
90	120	22	—	—	1	60 000	190 000	6 150	19 400	1 900	3 000	51118
	135	35	38.5	42	1.1	114 000	310 000	11 600	31 500	1 400	2 200	51218
	155	50	54.6	59	1.5	214 000	525 000	21 900	53 500	1 100	1 700	51318
	190	77	81.2	88	2.1	330 000	825 000	33 500	84 000	800	1 200	51418 X
100	135	25	—	—	1	86 000	268 000	8 750	27 300	1 700	2 600	51120
	150	38	40.9	45	1.1	135 000	375 000	13 700	38 500	1 300	2 000	51220
	170	55	59.2	64	1.5	239 000	595 000	24 300	61 000	1 000	1 500	51320
	210	85	90	98	3	370 000	985 000	38 000	100 000	710	1 100	51420 X

Note (1) The outside diameter *d*₁ of the shaft washers of all bearing numbers marked X is smaller than the outside diameter *D* of the housing washers.

Bearing Numbers ⁽¹⁾		Dimensions (mm)							Abutment and Fillet Dimensions (mm)			Mass(kg) approx.		
With Aligning Seat	With Aligning Seat Washer	<i>d</i> ₁	<i>D</i> ₁	<i>D</i> ₂	<i>D</i> ₃	<i>b</i>	<i>A</i>	<i>R</i>	<i>d</i> _a min.	<i>D</i> _a max.	<i>r</i> _a max.	With Flat Seat	With Aligning Seat	With Aligning Seat Washer
—	—	78	57	—	—	—	—	—	69	64	0.6	0.227	—	—
53211	53211 U	90	57	72	95	9	35	72	76	69	1	0.599	0.656	0.819
53311	53311 U	105	57	80	110	11.5	30	80	85	75	1	1.31	1.45	1.78
53411	53411 U	120	57	88	125	15.5	28	90	94	81	1.5	2.58	2.59	3.16
—	—	85	62	—	—	—	—	—	75	70	1	0.281	—	—
53212	53212 U	95	62	78	100	9	32.5	72	81	74	1	0.673	0.731	0.897
53312	53312 U	110	62	85	115	11.5	41	90	90	80	1	1.4	1.51	1.83
53412	53412 U	130	62	95	135	16	34	100	102	88	1.5	3.16	3.2	3.91
—	—	90	67	—	—	—	—	—	80	75	1	0.324	—	—
53213	53213 U	100	67	82	105	9	40	80	86	79	1	0.756	0.812	0.989
53313	53313 U	115	67	90	120	12.5	38.5	90	95	85	1	1.54	1.67	2.04
53413	53413 U	140	68	100	145	17.5	40	112	110	95	2	4.1	4.22	5.13
—	—	95	72	—	—	—	—	—	85	80	1	0.346	—	—
53214	53214 U	105	72	88	110	9	38	80	91	84	1	0.793	0.866	1.05
53314	53314 U	125	72	98	130	13	43	100	103	92	1	2.0	2.2	2.64
53414	53414 U	150	73	110	155	19.5	34	112	118	102	2	5.05	5.12	6.21
—	—	100	77	—	—	—	—	—	90	85	1	0.389	—	—
53215	53215 U	110	77	92	115	9.5	49	90	96	89	1	0.845	1.27	1.11
53315	53315 U	135	77	105	140	15	37	100	111	99	1.5	2.6	2.8	3.42
53415	53415 U	160	78	115	165	21	42	125	125	110	2	6.15	6.23	7.58
—	—	105	82	—	—	—	—	—	95	90	1	0.417	—	—
53216	53216 U	115	82	98	120	10	46	90	101	94	1	0.931	1.01	1.23
53316	53316 U	140	82	110	145	15	50	112	116	104	1.5	2.74	2.94	3.55
53416	53416 U	170	83	125	175	22	36	125	133	117	2	7.21	7.33	8.9
—	—	110	87	—	—	—	—	—	100	95	1	0.44	—	—
53217	53217 U	125	88	105	130	11	52	100	109	101	1	1.22	1.35	1.63
53317	53317 U	150	88	115	155	17.5	43	112	124	111	1.5	3.57	3.78	4.67
53417 X	53417 XU	177	88	130	185	23	47	140	141	124	2	8.51	8.72	10.4
—	—	120	92	—	—	—	—	—	108	102	1	0.646	—	—
53218	53218 U	135	93	110	140	13.5	45	100	117	108	1	1.69	1.89	2.38
53318	53318 U	155	93	120	160	18	40	112	129	116	1.5	3.83	4.11	5.09
53418 X	53418 XU	187	93	140	195	25.5	40	140	149	131	2	10.2	10.3	12.4
—	—	135	102	—	—	—	—	—	121	114	1	0.96	—	—
53220	53220 U	150	103	125	155	14	52	112	130	120	1	2.25	2.49	3.03
53320	53320 U	170	103	135	175	18	46	125	142	128	1.5	4.98	5.31	6.37
53420 X	53420 XU	205	103	155	220	27	50	160	165	145	2.5	14.8	15	18.1

Bore Diameter 110 – 190 mm

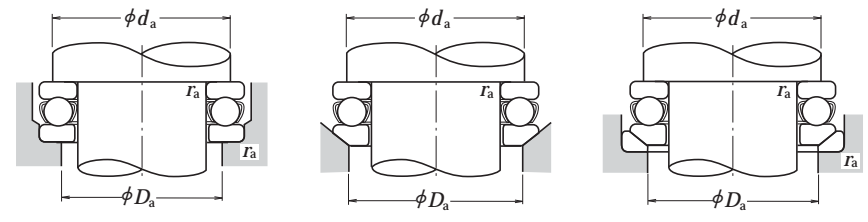
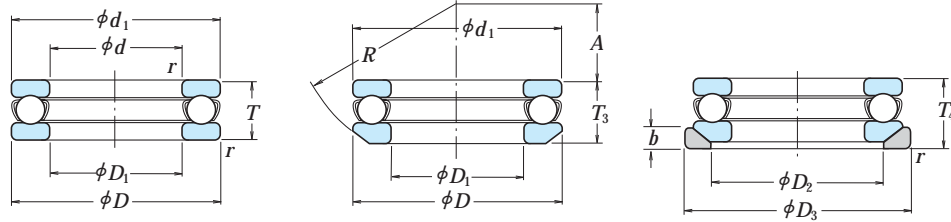

With Flat Seat

With Aligning Seat

With Aligning Seat Washer

Boundary Dimensions (mm)							Basic Load Ratings (N)				Limiting Speeds (min ⁻¹)		With Flat Seat
d	D	T	T ₃	T ₄	r min.	C _a	C _{0a}	C _a (kgf)	C _{0a} (kgf)	Grease	Oil		
110	145	25	—	—	1	88 000	288 000	8 950	29 400	1 700	2 400	51122	
	160	38	40.2	45	1.1	136 000	395 000	13 900	40 000	1 300	1 900	51222	
	190	63	67.2	72	2	282 000	755 000	28 800	77 000	900	1 300	51322 X	
	230	95	99.7	109	3	415 000	1 150 000	42 000	118 000	630	950	51422 X	
120	155	25	—	—	1	90 000	310 000	9 150	31 500	1 600	2 400	51124	
	170	39	40.8	46	1.1	141 000	430 000	14 400	44 000	1 200	1 800	51224	
	210	70	74.1	80	2.1	330 000	930 000	33 500	95 000	800	1 200	51324 X	
	250	102	107.3	118	4	480 000	1 400 000	49 000	142 000	600	900	51424 X	
130	170	30	—	—	1	105 000	350 000	10 700	36 000	1 400	2 000	51126	
	190	45	47.9	53	1.5	183 000	550 000	18 700	56 000	1 100	1 600	51226 X	
	225	75	80.3	86	2.1	350 000	1 030 000	35 500	105 000	750	1 100	51326 X	
	270	110	115.2	128	4	525 000	1 590 000	53 500	162 000	530	800	51426 X	
140	180	31	—	—	1	107 000	375 000	11 000	38 500	1 300	2 000	51128 X	
	200	46	48.6	55	1.5	186 000	575 000	18 900	59 000	1 000	1 500	51228 X	
	240	80	84.9	92	2.1	370 000	1 130 000	37 500	115 000	670	1 000	51328 X	
	280	112	117	131	4	550 000	1 750 000	56 500	178 000	530	800	51428 X	
150	190	31	—	—	1	110 000	400 000	11 200	41 000	1 300	1 900	51130 X	
	215	50	53.3	60	1.5	238 000	735 000	24 300	75 000	950	1 400	51230 X	
	250	80	83.7	92	2.1	380 000	1 200 000	39 000	123 000	670	1 000	51330 X	
	300	120	125.9	140	4	620 000	2 010 000	63 000	205 000	480	710	51430 X	
160	200	31	—	—	1	113 000	425 000	11 500	43 500	1 200	1 900	51132 X	
	225	51	54.7	61	1.5	249 000	805 000	25 400	82 000	900	1 400	51232 X	
	270	87	91.7	100	3	475 000	1 570 000	48 500	160 000	600	900	51332 X	
	320	130	135.3	150	5	650 000	2 210 000	66 000	226 000	450	670	51432 X	
170	215	34	—	—	1.1	135 000	510 000	13 800	52 000	1 100	1 700	51134 X	
	240	55	58.7	65	1.5	280 000	915 000	28 500	93 000	850	1 300	51234 X	
	280	87	91.3	100	3	465 000	1 570 000	47 500	160 000	600	900	51334 X	
	340	135	141	156	5	715 000	2 480 000	73 000	253 000	430	630	51434 X	
180	225	34	—	—	1.1	136 000	530 000	13 800	53 000	1 100	1 700	51136 X	
	250	56	58.2	66	1.5	284 000	955 000	28 900	97 000	800	1 200	51236 X	
	300	95	99.3	109	3	480 000	1 680 000	49 000	171 000	560	850	51336 X	
	360	140	148.3	164	5	750 000	2 730 000	76 500	278 000	400	600	51436 X	
190	240	37	—	—	1.1	172 000	655 000	17 500	67 000	1 000	1 600	51138 X	
	270	62	65.7	73	2	320 000	1 110 000	32 500	113 000	750	1 100	51238 X	
	320	105	111	121	4	550 000	1 960 000	56 000	199 000	500	750	51338 X	

Bearing Numbers ⁽¹⁾		Dimensions (mm)							Abutment and Fillet Dimensions (mm)			Mass(kg) approx.		
With Aligning Seat	With Aligning Seat Washer	d ₁	D ₁	D ₂	D ₃	b	A	R	d _a min.	D _a max.	r _a max.	With Flat Seat	With Aligning Seat	With Aligning Seat Washer
—	—	145	112	—	—	—	—	—	131	124	1	1.04	—	—
53222	53222 U	160	113	135	165	14	65	125	140	130	1	2.42	2.65	3.2
53322 X	53322 XU	187	113	150	195	20.5	51	140	158	142	2	7.19	7.55	9.1
53422 X	53422 XU	225	113	170	240	29	59	180	181	159	2.5	20	20.5	24.3
—	—	155	122	—	—	—	—	—	141	134	1	1.12	—	—
53224	53224 U	170	123	145	175	15	61	125	150	140	1	2.7	2.94	3.58
53324 X	53324 XU	205	123	165	220	22	63	160	173	157	2	9.7	10.1	12.4
53424 X	53424 XU	245	123	185	260	32	70	200	196	174	3	26.2	26.5	31.3
—	—	170	132	—	—	—	—	—	154	146	1	1.68	—	—
53226 X	53226 XU	187	133	160	195	17	67	140	166	154	1.5	3.95	4.35	5.33
53326 X	53326 XU	220	134	177	235	26	53	160	186	169	2	12.1	12.7	15.8
53426 X	53426 XU	265	134	200	280	38	58	200	212	188	3	32.3	32.4	38.8
—	—	178	142	—	—	—	—	—	164	156	1	1.83	—	—
53228 X	53228 XU	197	143	170	210	17	87	160	176	164	1.5	4.3	4.74	5.89
53328 X	53328 XU	235	144	190	250	26	68	180	199	181	2	14.2	16.3	19.5
53428 X	53428 XU	275	144	206	290	38	83	225	222	198	3	34.7	34.8	41.4
—	—	188	152	—	—	—	—	—	174	166	1	1.95	—	—
53230 X	53230 XU	212	153	180	225	20.5	79	160	189	176	1.5	5.52	6.09	7.82
53330 X	53330 XU	245	154	200	260	26	89.5	200	209	191	2	15	17.3	20.5
53430 X	53430 XU	295	154	225	310	41	69	225	238	212	3	43.5	43.8	51.9
—	—	198	162	—	—	—	—	—	184	176	1	2.07	—	—
53232 X	53232 XU	222	163	190	235	21	74	160	199	186	1.5	6.04	6.78	8.7
53332 X	53332 XU	265	164	215	280	29	77	200	225	205	2.5	19.6	22.3	26.7
53432 X	53432 XU	315	164	240	330	41.5	84	250	254	226	4	52.7	52.9	62
—	—	213	172	—	—	—	—	—	197	188	1	2.72	—	—
53234 X	53234 XU	237	173	200	250	21.5	91	180	212	198	1.5	7.41	8.21	10.5
53334 X	53334 XU	275	174	220	290	29	105	225	235	215	2.5	20.3	23.2	28
53434 X	53434 XU	335	174	255	350	46	74	250	269	241	4	61.2	61.3	73
—	—	222	183	—	—	—	—	—	207	198	1	2.79	—	—
53236 X	53236 XU	247	183	210	260	21.5	112	200	222	208	1.5	7.94	8.57	10.8
53336 X	53336 XU	295	184	240	310	32	91	225	251	229	2.5	25.9	29.2	34.9
53436 X	53436 XU	355	184	270	370	46.5	97	280	285	255	4	70.5	72.1	84.9
—	—	237	193	—	—	—	—	—	220	210	1	3.6	—	—
53238 X	53238 XU	267	194	230	280	23	98	200	238	222	2	11.8	12.9	15.7
53338 X	53338 XU	315	195	255	330	33	104	250	266	244	3	36.5	38.1	44.7

Note (1) The outside diameter d₁ of the shaft washers of all bearing numbers marked X is smaller than the outside diameter D of the housing washers.

Bore Diameter 200 – 360 mm

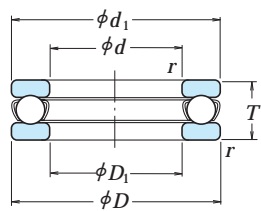

With Flat Seat

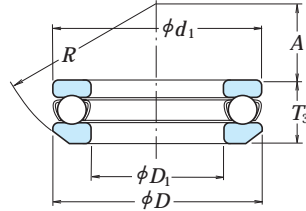

With Aligning Seat

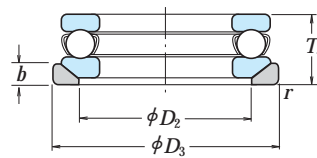

With Aligning Seat Washer

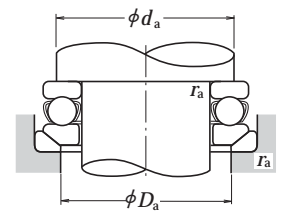
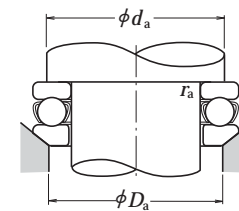
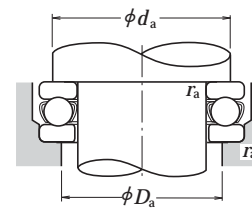

<i>d</i>	Boundary Dimensions (mm)					Basic Load Ratings (N)				Limiting Speeds (min ⁻¹)		With Flat Seat
	<i>D</i>	<i>T</i>	<i>T</i> ₃	<i>T</i> ₄	<i>r</i> _{min.}	<i>C</i> _a	<i>C</i> _{0a}	<i>C</i> _a	<i>C</i> _{0a}	Grease	Oil	
200	250	37	—	—	1.1	173 000	675 000	17 600	69 000	1 000	1 500	51140 X
	280	62	65.3	74	2	315 000	1 110 000	32 500	113 000	710	1 100	51240 X
	340	110	118.4	130	4	600 000	2 220 000	61 500	227 000	480	710	51340 X
220	270	37	—	—	1.1	179 000	740 000	18 200	75 500	950	1 500	51144 X
	300	63	65.6	75	2	325 000	1 210 000	33 500	123 000	670	1 000	51244 X
240	300	45	—	—	1.5	229 000	935 000	23 400	95 000	850	1 200	51148 X
	340	78	81.6	92	2.1	420 000	1 650 000	43 000	168 000	560	850	51248 X
260	320	45	—	—	1.5	233 000	990 000	23 800	101 000	800	1 200	51152 X
	360	79	82.8	93	2.1	435 000	1 800 000	44 500	184 000	560	850	51252 X
280	350	53	—	—	1.5	315 000	1 310 000	32 000	134 000	710	1 000	51156 X
	380	80	85	94	2.1	450 000	1 950 000	46 000	199 000	530	800	51256 X
300	380	62	—	—	2	360 000	1 560 000	36 500	159 000	600	900	51160 X
	420	95	100.5	112	3	540 000	2 410 000	55 000	246 000	450	670	51260 X
320	400	63	—	—	2	365 000	1 660 000	37 500	169 000	600	900	51164 X
	440	95	100.5	112	3	585 000	2 680 000	59 500	273 000	450	670	51264 X
340	420	64	—	—	2	375 000	1 760 000	38 500	179 000	560	850	51168 X
	460	96	100.3	113	3	595 000	2 800 000	60 500	285 000	430	630	51268 X
360	440	65	—	—	2	385 000	1 860 000	39 000	190 000	560	800	51172 X
	500	110	116.7	130	4	705 000	3 500 000	72 000	355 000	380	560	51272 X

Note (1) The outside diameter *d*₁ of the shaft washers of all bearing numbers marked X is smaller than the outside diameter *D* of the housing washers.

Bearing Numbers ⁽¹⁾		Dimensions (mm)							Abutment and Fillet Dimensions (mm)			Mass(kg) approx.		
With Aligning Seat	With Aligning Seat Washer	<i>d</i> ₁	<i>D</i> ₁	<i>D</i> ₂	<i>D</i> ₃	<i>b</i>	<i>A</i>	<i>R</i>	<i>d</i> _a min.	<i>D</i> _a max.	<i>r</i> _a max.	With Flat Seat	With Aligning Seat	With Aligning Seat Washer
—	—	247	203	—	—	—	—	—	230	220	1	3.75	—	—
53240 X	53240 XU	277	204	240	290	23	125	225	248	232	2	12.3	13.4	16.1
53340 X	53340 XU	335	205	270	350	38	92	250	282	258	3	43.6	46.2	54.8
—	—	267	223	—	—	—	—	—	250	240	1	4.09	—	—
53244 X	53244 XU	297	224	260	310	25	118	225	268	252	2	13.6	14.9	18
—	—	297	243	—	—	—	—	—	276	264	1.5	6.55	—	—
53248 X	53248 XU	335	244	290	350	30	122	250	299	281	2	23.7	25.6	30.7
—	—	317	263	—	—	—	—	—	296	284	1.5	7.01	—	—
53252 X	53252 XU	355	264	305	370	30	152	280	319	301	2	25.1	27.3	33.2
—	—	347	283	—	—	—	—	—	322	308	1.5	12	—	—
53256 X	53256 XU	375	284	325	390	31	143	280	339	321	2	27.1	30.3	37
—	—	376	304	—	—	—	—	—	348	332	2	17.2	—	—
53260 X	53260 XU	415	304	360	430	34	164	320	371	349	2.5	43.5	47.7	56.1
—	—	396	324	—	—	—	—	—	368	352	2	18.6	—	—
53264 X	53264 XU	435	325	380	450	36	157	320	391	369	2.5	45	49.9	59.4
—	—	416	344	—	—	—	—	—	388	372	2	19.9	—	—
53268 X	53268 XU	455	345	400	470	36	199	360	411	389	2.5	47.9	52.7	62
—	—	436	364	—	—	—	—	—	408	392	2	21.5	—	—
53272 X	53272 XU	495	365	430	510	43	172	360	442	418	3	68.8	76.3	90.9

Bore Diameter 10 – 55 mm

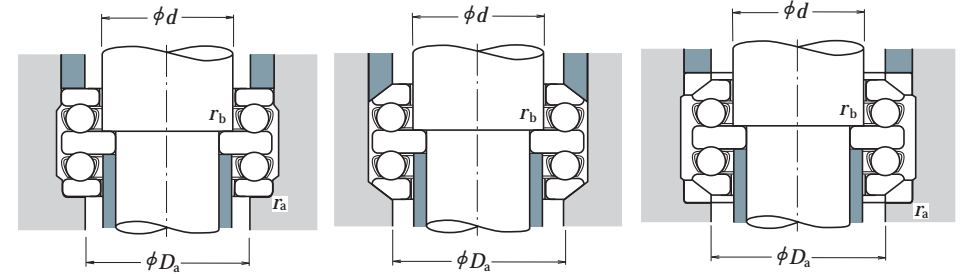
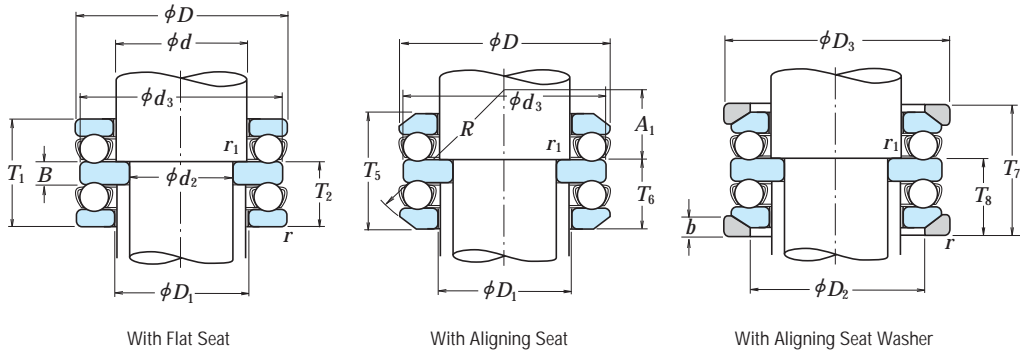

Boundary Dimensions (mm)								Basic Load Ratings (N)				Limiting Speeds (min ⁻¹)		Bearing Numbers	
<i>d</i> ₂	<i>d</i>	<i>D</i>	<i>T</i> ₁	<i>T</i> ₅	<i>T</i> ₇	<i>r</i> _{min.}	<i>r</i> _{1 min.}	<i>C</i> _a	<i>C</i> _{0a}	<i>C</i> _a	<i>C</i> _{0a}	Grease	Oil	With Flat Seat	With Aligning Seat
10	15	32	22	24.6	28	0.6	0.3	16 700	24 800	1 710	2 530	4 800	7 100	52202	54202
15	20	40	26	27.4	32	0.6	0.3	22 500	37 500	2 290	3 850	4 000	6 000	52204	54204
	25	60	45	49.8	55	1	0.6	56 000	89 500	5 700	9 100	2 400	3 600	52405	54405
20	25	47	28	31.4	36	0.6	0.3	28 000	50 500	2 860	5 150	3 400	5 300	52205	54205
	25	52	34	37.6	42	1	0.3	36 000	61 500	3 650	6 250	3 000	4 500	52305	54305
	30	70	52	56.2	62	1	0.6	73 000	126 000	7 450	12 800	2 200	3 200	52406	54406
25	30	52	29	32.6	37	0.6	0.3	29 500	58 000	3 000	5 950	3 200	5 000	52206	54206
	30	60	38	41.2	46	1	0.3	43 000	78 500	4 400	8 000	2 600	4 000	52306	54306
	35	80	59	63	69	1.1	0.6	87 500	155 000	8 950	15 800	1 800	2 800	52407	54407
30	35	62	34	37.8	42	1	0.3	39 500	78 000	4 050	7 950	2 800	4 300	52207	54207
	35	68	44	47.2	52	1	0.3	56 000	105 000	5 700	10 700	2 400	3 600	52307	54307
	40	68	36	38.6	44	1	0.6	47 500	98 500	4 850	10 000	2 600	3 800	52208	54208
40	40	78	49	54	59	1	0.6	70 000	135 000	7 100	13 700	2 000	3 000	52308	54308
	40	90	65	69.4	77	1.1	0.6	103 000	188 000	10 500	19 100	1 700	2 400	52408	54408
	35	45	73	37	39.6	45	1	0.6	48 000	105 000	4 900	10 700	2 400	3 600	52209
45		85	52	56.2	62	1	0.6	80 500	163 000	8 200	16 700	1 900	2 800	52309	54309
45		100	72	78.8	86	1.1	0.6	128 000	246 000	13 000	25 100	1 500	2 200	52409	54409
40	50	78	39	42	47	1	0.6	49 000	111 000	5 000	11 400	2 400	3 400	52210	54210
	50	95	58	64.6	70	1.1	0.6	97 500	202 000	9 950	20 600	1 700	2 600	52310	54310
	50	110	78	83.2	92	1.5	0.6	147 000	288 000	15 000	29 400	1 400	2 000	52410	54410
45	55	90	45	49.6	55	1	0.6	70 000	159 000	7 150	16 200	2 000	3 000	52211	54211
	55	105	64	72.6	78	1.1	0.6	115 000	244 000	11 800	24 900	1 500	2 400	52311	54311
	55	120	87	92	101	1.5	0.6	181 000	350 000	18 500	35 500	1 200	1 800	52411	54411
50	60	95	46	50	56	1	0.6	71 500	169 000	7 300	17 200	1 900	3 000	52212	54212
	60	110	64	70.6	78	1.1	0.6	119 000	263 000	12 100	26 800	1 500	2 200	52312	54312
	60	130	93	99	107	1.5	0.6	202 000	395 000	20 600	40 500	1 100	1 700	52412	54412
	65	140	101	109.4	119	2	1	234 000	495 000	23 800	50 500	1 000	1 600	52413	54413
55	65	100	47	50.4	57	1	0.6	75 500	189 000	7 700	19 200	1 900	2 800	52213	54213
	65	115	65	71.8	79	1.1	0.6	123 000	282 000	12 500	28 700	1 500	2 200	52313	54313
	70	105	47	50.6	57	1	1	74 000	189 000	7 550	19 200	1 800	2 800	52214	54214
	70	125	72	80.4	88	1.1	1	137 000	315 000	14 000	32 000	1 300	2 000	52314	54314
70	150	107	114.2	125	2	1	252 000	555 000	25 700	56 500	1 000	1 500	52414	54414	

With Aligning Seat Washer	Dimensions (mm)											Abutment and Fillet Dimensions (mm)			Mass(kg) approx.		
	<i>d</i> ₃	<i>D</i> ₁	<i>D</i> ₂	<i>D</i> ₃	<i>T</i> ₂	<i>T</i> ₆	<i>T</i> ₈	<i>B</i>	<i>b</i>	<i>A</i> ₁	<i>R</i>	<i>D</i> _{a max.}	<i>r</i> _{a max.}	<i>r</i> _{b max.}	With Flat Seat	With Aligning Seat	With Aligning Seat Washer
54202 U	32	17	24	35	13.5	14.8	16.5	5	4	10.5	28	24	0.6	0.3	0.081	0.090	0.113
54204 U	40	22	30	42	16	16.7	19	6	5	16	36	30	0.6	0.3	0.148	0.151	0.185
54405 U	60	27	42	62	28	30.4	33	11	8	15	50	42	1	0.6	0.641	0.68	0.825
54205 U	47	27	36	50	17.5	19.2	21.5	7	5.5	16.5	40	36	0.6	0.3	0.213	0.236	0.293
54305 U	52	27	38	55	21	22.8	25	8	6	18	45	38	1	0.3	0.324	0.35	0.434
54406 U	70	32	50	75	32	34.1	37	12	9	16	56	50	1	0.6	0.978	1.01	1.27
54206 U	52	32	42	55	18	19.8	22	7	5.5	20	45	42	0.6	0.3	0.254	0.288	0.345
54306 U	60	32	45	62	23.5	25.1	27.5	9	7	19.5	50	45	1	0.3	0.483	0.511	0.621
54407 U	80	37	58	85	36.5	38.5	41.5	14	10	18.5	64	58	1	0.6	1.43	1.47	1.83
54207 U	62	37	48	65	21	22.9	25	8	7	21	50	48	1	0.3	0.406	0.447	0.57
54307 U	68	37	52	72	27	28.6	31	10	7.5	21	56	52	1	0.3	0.71	0.744	0.915
54208 U	68	42	55	72	22.5	23.8	26.5	9	7	25	56	55	1	0.6	0.543	0.581	0.713
54308 U	78	42	60	82	30.5	33	35.5	12	8.5	23.5	64	60	1	0.6	1.04	1.13	1.38
54408 U	90	42	65	95	40	42.2	46	15	12	22	72	65	1	0.6	1.98	2.02	2.54
54209 U	73	47	60	78	23	24.3	27	9	7.5	23	56	60	1	0.6	0.606	0.652	0.823
54309 U	85	47	65	90	32	34.1	37	12	10	21	64	65	1	0.6	1.28	1.34	1.71
54409 U	100	47	72	105	44.5	47.9	51.5	17	12.5	23.5	80	72	1	0.6	2.71	2.85	3.53
54210 U	78	52	62	82	24	25.5	28	9	7.5	30.5	64	62	1	0.6	0.697	0.75	0.949
54310 U	95	52	72	100	36	39.3	42	14	11	23	72	72	1	0.6	1.78	1.94	2.46
54410 U	110	52	80	115	48	50.6	55	18	14	30	90	80	1.5	0.6	3.51	3.59	4.45
54211 U	90	57	72	95	27.5	29.8	32.5	10	9	32.5	72	72	1	0.6	1.11	1.22	1.55
54311 U	105	57	80	110	39.5	43.8	46.5	15	11.5	25.5	80	80	1	0.6	2.43	2.7	3.35
54411 U	120	57	88	125	53.5	56	60.5	20	15.5	22.5	90	88	1.5	0.6	4.66	4.68	5.82
54212 U	95	62	78	100	28	30	33	10	9	30.5	72	78	1	0.6	1.22	1.33	1.66
54312 U	110	62	85	115	39.5	42.8	46.5	15	11.5	36.5	90	85	1	0.6	2.59	2.82	3.45
54412 U	130	62	95	135	57	60	64	21	16	28	100	95	1.5	0.6	5.74	5.82	7.24
54413 U	140	68	100	145	62	66.2	71	23	17.5	34	112	100	2	1	7.41	7.66	9.47
54213 U	100	67	82	105	28.5	30.2	33.5	10	9	38.5	80	82	1	0.6	1.34	1.45	1.81
54313 U	115	67	90	120	40	43.4	47	15	12.5	34.5	90	90	1	0.6	2.8	3.06	3.8
54214 U	105	72	88	110	28.5	30.3	33.5	10	9	36.5	80	88	1	1	1.44	1.59	1.95
54314 U	125	72	98	130	44	48.2	52	16	13	39	100	98	1	1	3.67	4.07	4.95
54414 U	150	73	110	155	65.5	69.1	74.5	24	19.5	28.5	112	110	2	1	8.99	9.12	11.3

Bore Diameter 60 – 130 mm

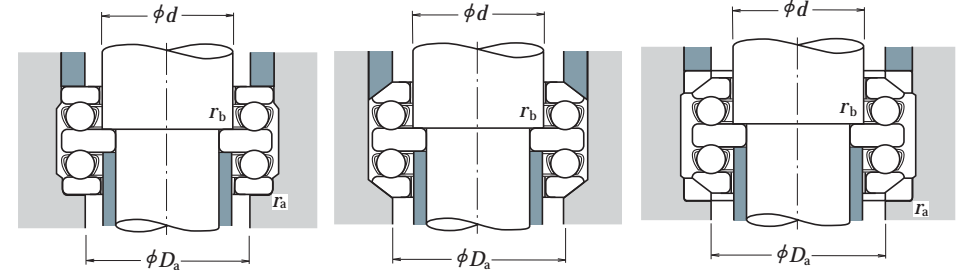
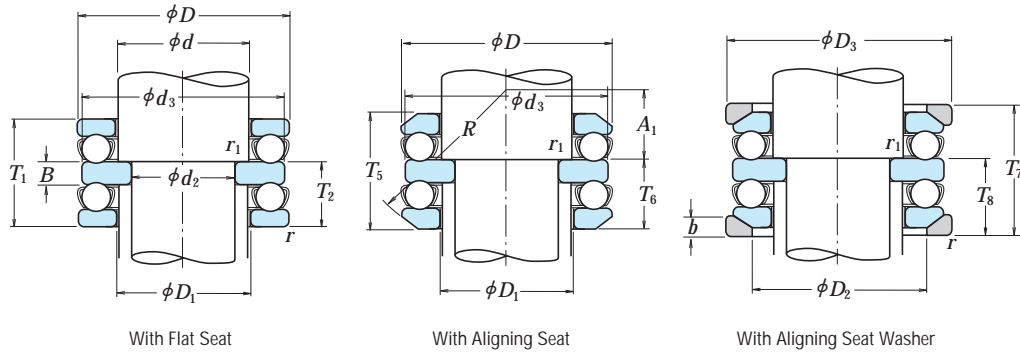

d ₂	Boundary Dimensions (mm)							Basic Load Ratings (N) (kgf)				Limiting Speeds (min ⁻¹)		Bearing Numbers ⁽¹⁾	
	d	D	T ₁	T ₅	T ₇	r _{min.}	r _{1 min.}	C _a	C _{0a}	C _a	C _{0a}	Grease	Oil	With Flat Seat	With Aligning Seat
60	75	110	47	49.6	57	1	1	78 000	209 000	7 950	21 300	1 800	2 600	52215	54215
	75	135	79	87.2	95	1.5	1	159 000	365 000	16 200	37 500	1 200	1 800	52315	54315
	75	160	115	123	135	2	1	254 000	560 000	25 900	57 000	900	1 400	52415	54415
65	80	115	48	51	58	1	1	79 000	218 000	8 050	22 300	1 700	2 600	52216	54216
	80	140	79	86.2	95	1.5	1	164 000	395 000	16 700	40 000	1 200	1 800	52316	54316
	80	170	120	128.4	140	2.1	1	272 000	620 000	27 800	63 500	850	1 300	52416	54416
	85	180	128	138	150	2.1	1.1	310 000	755 000	31 500	77 000	800	1 200	52417 X	54417 X
70	85	125	55	59.2	67	1	1	96 000	264 000	9 800	26 900	1 500	2 200	52217	54217
	85	150	87	95.2	105	1.5	1	207 000	490 000	21 100	50 000	1 100	1 600	52317	54317
	90	190	135	143.4	157	2.1	1.1	330 000	825 000	33 500	84 000	750	1 100	52418 X	54418 X
75	90	135	62	69	76	1.1	1	114 000	310 000	11 600	31 500	1 400	2 000	52218	54218
	90	155	88	97.2	106	1.5	1	214 000	525 000	21 900	53 500	1 100	1 600	52318	54318
80	100	210	150	160	176	3	1.1	370 000	985 000	38 000	100 000	670	1 000	52420 X	54420 X
85	100	150	67	72.8	81	1.1	1	135 000	375 000	13 700	38 500	1 300	1 900	52220	54220
	100	170	97	105.4	115	1.5	1	239 000	595 000	24 300	61 000	950	1 500	52320	54320
90	110	230	166	—	—	3	1.1	415 000	1 150 000	42 000	118 000	600	900	52422 X	—
95	110	160	67	71.4	81	1.1	1	136 000	395 000	13 900	40 000	1 200	1 800	52222	54222
	110	190	110	118.4	128	2	1	282 000	755 000	28 800	77 000	850	1 300	52322 X	54322 X
	120	250	177	—	—	4	1.5	515 000	1 540 000	52 500	157 000	560	850	52424 X	—
100	120	170	68	71.6	82	1.1	1.1	141 000	430 000	14 400	44 000	1 200	1 800	52224	54224
	120	210	123	131.2	143	2.1	1.1	330 000	930 000	33 500	95 000	750	1 100	52324 X	54324 X
	130	270	192	—	—	4	1.5	525 000	1 590 000	53 500	162 000	530	800	52426 X	—
110	130	190	80	85.8	96	1.5	1.1	183 000	550 000	18 700	56 000	1 000	1 500	52226 X	54226 X
	130	225	130	—	—	2.1	1.1	350 000	1 030 000	35 500	105 000	710	1 100	52326 X	—
	140	280	196	—	—	4	1.5	550 000	1 750 000	56 500	178 000	500	750	52428 X	—
120	140	200	81	86.2	99	1.5	1.1	186 000	575 000	18 900	59 000	1 000	1 500	52228 X	54228 X
	140	240	140	—	—	2.1	1.1	370 000	1 130 000	37 500	115 000	670	1 000	52328 X	—
	150	300	209	—	—	4	2	620 000	2 010 000	63 000	205 000	480	710	52430 X	—
130	150	215	89	95.6	109	1.5	1.1	238 000	735 000	24 300	75 000	900	1 300	52230 X	54230 X
	150	250	140	—	—	2.1	1.1	380 000	1 200 000	39 000	123 000	630	950	52330 X	—
	160	320	226	—	—	5	2	650 000	2 210 000	66 000	226 000	430	630	52432 X	—

Note (1) The outside diameter d_3 of the central washers of all bearing numbers marked X is smaller than the outside diameter D of the housing washers.

With Aligning Seat Washer	Dimensions (mm)											Abutment and Fillet Dimensions (mm)			Mass(kg) approx.		
	d ₃	D ₁	D ₂	D ₃	T ₂	T ₆	T ₈	B	b	A ₁	R	D _{a max.}	r _{a max.}	r _{b max.}	With Flat Seat	With Aligning Seat	With Aligning Seat Washer
54215 U	110	77	92	115	28.5	29.8	33.5	10	9.5	47.5	90	92	1	1	1.54	1.66	2.06
54315 U	135	77	105	140	48.5	52.6	56.5	18	15	32.5	100	105	1.5	1	4.74	5.14	6.38
54415 U	160	78	115	165	70.5	74.5	80.5	26	21	36.5	125	115	2	1	10.8	11	13.7
54216 U	115	82	98	120	29	30.5	34	10	10	45	90	98	1	1	1.66	1.78	2.21
54316 U	140	82	110	145	48.5	52.1	56.5	18	15	45.5	112	110	1.5	1	4.99	5.39	6.61
54416 U	170	83	125	175	73.5	77.7	83.5	27	22	30.5	125	125	2	1	12.6	12.8	16
54417 XU	179.5	88	130	185	78.5	83.5	89.5	29	23	40.5	140	130	2	1	15.4	15.8	19.5
54217 U	125	88	105	130	33.5	35.6	39.5	12	11	49.5	100	105	1	1	2.26	2.45	3.02
54317 U	150	88	115	155	53	57.1	62	19	17.5	39	112	115	1.5	1	6.38	6.8	10.5
54418 XU	189.5	93	140	195	82.5	86.7	93.5	30	25.5	34.5	140	140	2	1	17.5	18.1	22.5
54218 U	135	93	110	140	38	41.5	45	14	13.5	42	100	110	1	1	3.09	3.42	4.39
54318 U	155	93	120	160	53.5	58.1	62.5	19	18	36.5	112	120	1.5	1	6.79	7.33	9.29
54420 XU	209.5	103	155	220	91.5	96.5	104.5	33	27	43.5	160	155	2.5	1	26.8	27.2	33.4
54220 U	150	103	125	155	41	43.9	48	15	14	49	112	125	1	1	4.08	4.54	5.64
54320 U	170	103	135	175	59	63.2	68	21	18	42	125	135	1.5	1	8.82	9.47	11.6
—	229	113	—	—	101.5	—	—	37	—	—	—	159	2.5	1	35.6	—	—
54222 U	160	113	135	165	41	43.2	48	15	14	62	125	135	1	1	4.39	4.83	5.94
54322 XU	189.5	113	150	195	67	71.2	76	24	20.5	47	140	150	2	1	12.7	13.5	16.6
—	249	123	—	—	108.5	—	—	40	—	—	—	174	3	1.5	47.6	—	—
54224 U	170	123	145	175	41.5	43.3	48.5	15	15	58.5	125	145	1	1	4.92	5.4	6.68
54324 XU	209.5	123	165	220	75	79.1	85	27	22	58	160	165	2	1	17.6	16.4	22.9
—	269	134	—	—	117	—	—	42	—	—	—	188	3	1.5	57.8	—	—
54226 XU	189.5	133	160	195	49	51.9	57	18	17	63	140	160	1.5	1	7.43	8.24	10.2
—	224	134	—	—	80	—	—	30	—	—	—	169	2	1	21.5	—	—
—	279	144	—	—	120	—	—	44	—	—	—	198	3	1.5	62.4	—	—
54228 XU	199.5	143	170	210	49.5	52.1	58.5	18	17	83.5	160	170	1.5	1	8.01	8.87	11.2
—	239	144	—	—	85.5	—	—	31	—	—	—	181	2	1	24.8	—	—
—	299	153	—	—	127.5	—	—	46	—	—	—	212	3	2	77.8	—	—
54230 XU	214.5	153	180	225	54.5	57.8	64.5	20	20.5	74.5	160	180	1.5	1	10.4	11.5	15
—	249	154	—	—	85.5	—	—	31	—	—	—	191	2	1	30.3	—	—
—	319	164	—	—	138	—	—	50	—	—	—	226	4	2	93.6	—	—

Bore Diameter 135 – 190 mm

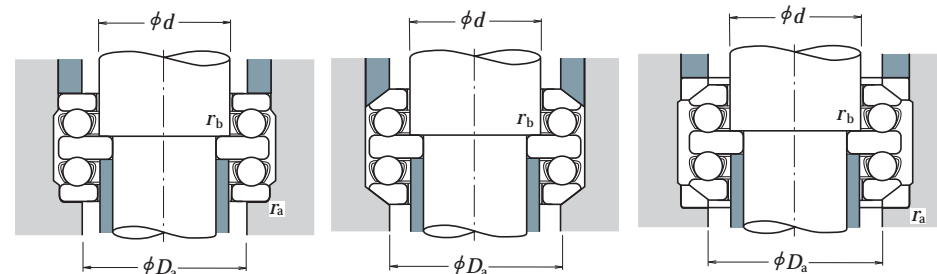
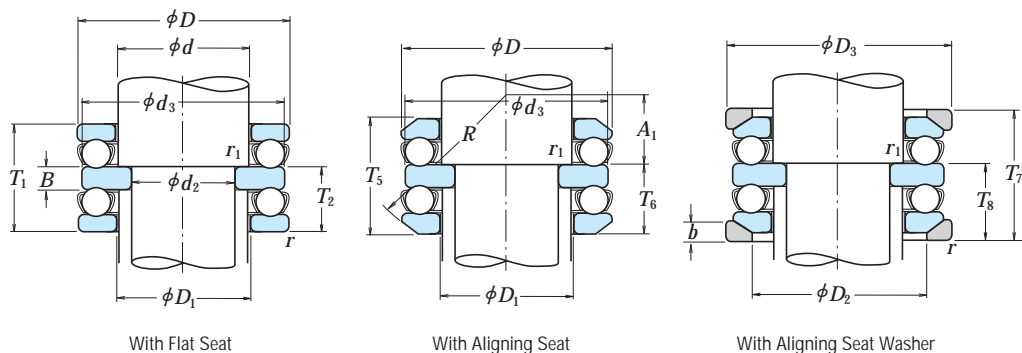

d_2	Boundary Dimensions (mm)							Basic Load Ratings (N)				Limiting Speeds (min ⁻¹)		Bearing Numbers ⁽¹⁾	
	d	D	T_1	T_5	T_7	$r_{min.}$	$r_{1min.}$	C_a	C_{0a}	C_a	C_{0a}	Grease	Oil	With Flat Seat	With Aligning Seat
135	170	340	236	—	—	5	2.1	715 000	2 480 000	73 000	253 000	400	600	52434 X	—
140	160	225	90	97.4	110	1.5	1.1	249 000	805 000	25 400	82 000	850	1 300	52232 X	54232 X
	160	270	153	—	—	3	1.1	475 000	1 570 000	48 500	160 000	600	900	52332 X	—
	180	360	245	—	—	5	3	750 000	2 730 000	76 500	278 000	380	560	52436 X	—
150	170	240	97	104.4	117	1.5	1.1	280 000	915 000	28 500	93 000	800	1 200	52234 X	54234 X
	170	280	153	—	—	3	1.1	465 000	1 570 000	47 500	160 000	560	850	52334 X	—
	180	250	98	102.4	118	1.5	2	284 000	955 000	28 900	97 000	800	1 200	52236 X	54236 X
160	180	300	165	—	—	3	2	480 000	1 680 000	49 000	171 000	530	800	52336 X	—
	190	270	109	116.4	131	2	2	320 000	1 110 000	32 500	113 000	710	1 100	52238 X	54238 X
	190	320	183	—	—	4	2	550 000	1 960 000	56 000	199 000	480	710	52338 X	—
170	200	280	109	115.6	133	2	2	315 000	1 110 000	32 500	113 000	710	1 000	52240 X	54240 X
	200	340	192	—	—	4	2	600 000	2 220 000	61 500	227 000	450	670	52340 X	—
190	220	300	110	115.2	134	2	2	325 000	1 210 000	33 500	123 000	670	1 000	52244 X	54244 X

Note (1) The outside diameter d_3 of the central washers of all bearing numbers marked X is smaller than the outside diameter D of the housing washers.

With Aligning Seat Washer	Dimensions (mm)											Abutment and Fillet Dimensions (mm)			Mass(kg) approx.		
	d_3	D_1	D_2	D_3	T_2	T_6	T_8	B	b	A_1	R	D_a max.	r_a max.	r_b max.	With Flat Seat	With Aligning Seat	With Aligning Seat Washer
—	339	174	—	—	143	—	—	50	—	—	—	240	4	2	110	—	—
54232 XU	224.5	163	190	235	55	58.7	65	20	21	70	160	190	1.5	1	11.2	12.7	16.5
	—	269	164	—	—	93	—	—	—	—	—	205	2.5	1	35.1	—	—
	—	359	184	—	—	148.5	—	—	—	—	—	254	4	2.5	126	—	—
54234 XU	239.5	173	200	250	59	62.7	69	21	21.5	87	180	200	1.5	1	13.6	15.2	19.8
	—	279	174	—	—	93	—	—	—	—	—	215	2.5	1	40.8	—	—
54236 XU	249	183	210	260	59.5	61.7	69.5	21	21.5	108.5	200	210	1.5	2	14.8	16.1	20.6
	—	299	184	—	—	101	—	—	—	—	—	229	2.5	2.5	46.3	—	—
54238 XU	269	194	230	280	66.5	70.2	77.5	24	23	93.5	200	230	2	2	22.1	22.2	29.8
	—	319	195	—	—	111.5	—	—	—	—	—	244	3	2	113	—	—
54240 XU	279	204	240	290	66.5	69.8	78.5	24	23	120.5	225	240	2	2	23.1	23.2	30.6
	—	339	205	—	—	117	—	—	—	—	—	258	3	2	78.4	—	—
54244 XU	299	224	260	310	67	69.6	79	24	25	114	225	260	2	2	25.2	27.8	34.1

Bore Diameter 35 – 130 mm

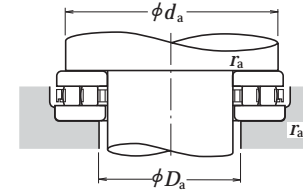
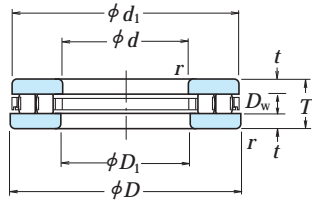

Boundary Dimensions (mm)				Basic Load Ratings (N)		Limiting Speeds (min ⁻¹)	
<i>d</i>	<i>D</i>	<i>T</i>	<i>r</i> _{min.}	<i>C_a</i>	<i>C_{0a}</i>	Grease	Oil
35	80	32	1.1	95 000	247 000	1 000	3 000
40	78	22	1	63 000	194 000	1 200	3 600
45	65	14	0.6	33 000	100 000	1 700	5 000
	85	24	1	71 000	233 000	1 100	3 400
50	110	27	1.1	139 000	470 000	900	2 800
	95	27	1.1	113 000	350 000	1 000	3 000
55	105	30	1.1	134 000	450 000	900	2 600
60	95	26	1	99 000	325 000	1 000	3 000
	110	30	1.1	139 000	480 000	850	2 600
65	100	27	1	110 000	325 000	950	2 800
	115	30	1.1	145 000	515 000	850	2 600
70	150	36	2	259 000	935 000	670	2 000
	125	34	1.1	191 000	635 000	750	2 200
75	100	19	1	63 500	221 000	1 100	3 400
	135	36	1.5	209 000	735 000	710	2 200
80	115	28	1	120 000	420 000	900	2 600
	140	36	1.5	208 000	740 000	710	2 000
85	110	19	1	75 000	298 000	1 100	3 200
	125	31	1	151 000	485 000	800	2 400
	150	39	1.5	257 000	995 000	630	1 900
90	120	22	1	96 000	370 000	950	3 000
	155	39	1.5	250 000	885 000	630	1 900
100	170	42	1.5	292 000	1 110 000	560	1 700
110	160	38	1.1	228 000	855 000	630	1 900
	190	48	2	390 000	1 490 000	500	1 500
120	170	39	1.1	233 000	895 000	600	1 800
	210	54	2.1	505 000	1 930 000	450	1 400
130	190	45	1.5	300 000	1 090 000	530	1 600
	225	58	2.1	585 000	2 370 000	430	1 300
	270	85	4	895 000	3 300 000	320	950

Bearing Numbers	Dimensions (mm)				Abutment and Fillet Dimensions (mm)			Mass (kg) approx.
	<i>d₁</i>	<i>D₁</i>	<i>D_w</i>	<i>t</i>	<i>d_a</i> _{min.}	<i>D_a</i> _{max.}	<i>r_a</i> _{max.}	
35 TMP 14	80	37	12	10	71	46	1	0.97
40 TMP 93	78	42	8	7	71	48	1	0.525
45 TMP 11	65	47	6	4	60	49	0.6	0.144
45 TMP 93	85	47	8	8	78	53	1	0.665
50 TMP 74	109	52	11	8	100	61	1	1.52
50 TMP 93	93	52	11	8	89	57	1	0.94
55 TMP 93	105	55.2	11	9.5	98	63	1	1.28
60 TMP 12	95	62	10	8	88	67	1	0.735
60 TMP 93	110	62	11	9.5	103	68	1	1.36
65 TMP 12	100	67	12.5	7.25	93	71	1	0.805
65 TMP 93	115	65.2	11	9.5	108	73	1	1.44
70 TMP 74	149	72	15	10.5	137	84	2	3.8
70 TMP 93	125	72	14	10	117	78	1	1.95
75 TMP 11	100	77	8	5.5	96	79	1	0.41
75 TMP 93	135	77	14	11	125	84	1.5	2.42
80 TMP 12	115	82	11	8.5	109	86	1	1.02
80 TMP 93	138	82	14	11	130	91	1.5	2.54
85 TMP 11	110	87	7.5	5.75	105	89	1	0.46
85 TMP 12	125	88	14	8.5	118	92	1	1.36
85 TMP 93	148	87	14	12.5	140	95	1.5	3.2
90 TMP 11	119	91.5	9	6.5	114	95	1	0.725
90 TMP 93	155	90.2	16	11.5	144	101	1.5	3.3
100 TMP 93	170	103	16	13	159	110	1.5	4.25
110 TMP 12	160	113	15	11.5	150	119	1	2.66
110 TMP 93	190	113	19	14.5	179	120	2	6.15
120 TMP 12	170	123	15	12	160	129	1	2.93
120 TMP 93	210	123	22	16	199	129	2	8.55
130 TMP 12	187	133	19	13	177	142	1.5	4.5
130 TMP 93	225	133	22	18	214	140	2	10.4
130 TMP 94	270	133	32	26.5	254	150	3	26.2

Remarks For cylindrical roller thrust bearings not listed above, please contact NSK.

Bore Diameter 140 – 320 mm

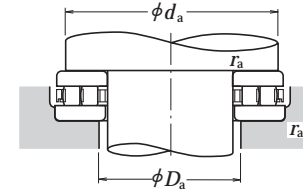
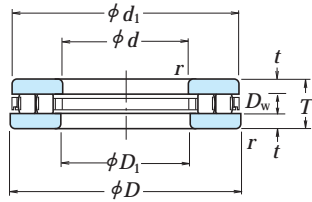

d	Boundary Dimensions (mm)			Basic Load Ratings (N)		Limiting Speeds (min ⁻¹)	
	D	T	r _{min.}	C _a	C _{0a}	Grease	Oil
140	200	46	2	285 000	1 120 000	500	1 500
	240	60	2.1	610 000	2 360 000	400	1 200
	280	85	4	990 000	3 800 000	300	900
150	215	50	2	375 000	1 500 000	480	1 400
	250	60	2.1	635 000	2 510 000	400	1 200
160	200	31	1	173 000	815 000	630	1 900
	270	67	3	745 000	3 150 000	360	1 100
170	240	55	1.5	485 000	1 960 000	430	1 300
	280	67	3	800 000	3 500 000	340	1 000
180	300	73	3	1 000 000	4 000 000	320	950
	360	109	5	1 640 000	6 200 000	240	710
190	270	62	3	705 000	2 630 000	360	1 100
	320	78	4	1 080 000	4 500 000	300	900
200	250	37	1.1	365 000	1 690 000	500	1 500
	340	85	4	1 180 000	5 150 000	280	800
220	270	37	1.1	385 000	1 860 000	480	1 500
	300	63	2	770 000	3 100 000	340	1 000
240	300	45	1.5	435 000	2 160 000	400	1 200
	340	78	2.1	965 000	4 100 000	280	850
260	320	45	1.5	460 000	2 350 000	400	1 200
	360	79	2.1	995 000	4 350 000	280	850
280	350	53	1.5	545 000	2 800 000	340	1 000
	380	80	2.1	1 050 000	4 750 000	260	800
300	380	62	2	795 000	4 000 000	300	900
	420	95	3	1 390 000	6 250 000	220	670
320	400	63	2	820 000	4 250 000	300	900
	440	95	3	1 420 000	6 550 000	220	670

Bearing Numbers	Dimensions (mm)				Abutment and Fillet Dimensions (mm)			Mass (kg) approx.
	d ₁	D ₁	D _w	t	d _a min.	D _a max.	r _a max.	
140 TMP 12	197	143	17	14.5	188	153	2	4.85
140 TMP 93	240	143	25	17.5	226	154	2	12.2
140 TMP 94	280	143	32	26.5	262	158	3	27.5
150 TMP 12	215	153	19	15.5	202	163	2	6.15
150 TMP 93	250	153	25	17.5	236	165	2	12.8
160 TMP 11	200	162	11	10	191	168	1	2.21
160 TMP 93	265	164	25	21	255	173	2.5	16.9
170 TMP 12	237	173	22	16.5	227	182	1.5	8.2
170 TMP 93	280	173	25	21	265	183	2.5	17.7
180 TMP 93	300	185	32	20.5	284	194	2.5	22.5
180 TMP 94	354	189	45	32	335	205	4	58.2
190 TMP 12	266	195	30	16	255	200	2.5	11.8
190 TMP 93	320	195	32	23	303	205	3	27.6
200 TMP 11	247	203	17	10	242	207	1	4.1
200 TMP 93	340	205	32	26.5	322	218	3	34.5
220 TMP 11	267	223	17	10	262	227	1	4.5
220 TMP 12	297	224	30	16.5	287	232	2	13.5
240 TMP 11	297	243	18	13.5	288	251	1.5	7.2
240 TMP 12	335	244	32	23	322	258	2	23.3
260 TMP 11	317	263	18	13.5	308	272	1.5	7.75
260 TMP 12	355	264	32	23.5	342	276	2	25.2
280 TMP 11	347	283	20	16.5	335	294	1.5	11.6
280 TMP 12	375	284	32	24	362	296	2	27.2
300 TMP 11	376	304	25	18.5	365	315	2	16.7
300 TMP 12	415	304	38	28.5	398	322	2.5	42
320 TMP 11	396	324	25	19	385	335	2	18
320 TMP 12	435	325	38	28.5	418	340	2.5	44.5

Remarks For cylindrical roller thrust bearings not listed above, please contact NSK.

Bore Diameter 60 – 200 mm

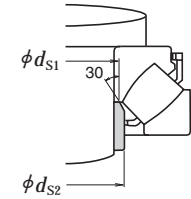
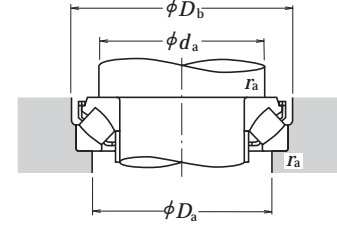
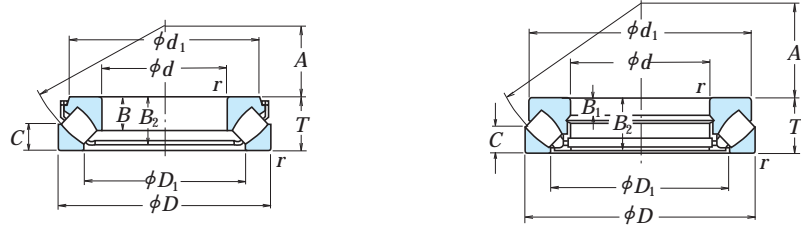

Dynamic Equivalent Load
 $P = 1.2F_r + F_a$
 Static Equivalent Load
 $P_0 = 2.8F_r + F_a$
 However, $F_r/F_a \leq 0.55$ must be satisfied.

Boundary Dimensions (mm)				Basic Load Ratings				Limiting Speeds (min ⁻¹) Oil	Bearing Numbers
<i>d</i>	<i>D</i>	<i>T</i>	<i>r</i> min.	<i>C_a</i> (N)	<i>C_{0a}</i> (kgf)	<i>C_a</i> (kgf)	<i>C_{0a}</i> (kgf)		
60	130	42	1.5	330 000	885 000	33 500	90 000	2 600	29412 E
65	140	45	2	405 000	1 100 000	41 500	112 000	2 400	29413 E
70	150	48	2	450 000	1 240 000	46 000	126 000	2 400	29414 E
75	160	51	2	515 000	1 430 000	52 500	146 000	2 200	29415 E
80	170	54	2.1	575 000	1 600 000	58 500	163 000	2 000	29416 E
85	150	39	1.5	330 000	1 040 000	34 000	106 000	2 400	29317 E
	180	58	2.1	630 000	1 760 000	64 500	179 000	1 900	29417 E
90	155	39	1.5	350 000	1 080 000	35 500	110 000	2 200	29318 E
	190	60	2.1	695 000	1 950 000	70 500	199 000	1 800	29418 E
100	170	42	1.5	410 000	1 280 000	41 500	131 000	2 000	29320 E
	210	67	3	840 000	2 400 000	86 000	245 000	1 600	29420 E
110	190	48	2	530 000	1 710 000	54 000	174 000	1 800	29322 E
	230	73	3	1 010 000	2 930 000	103 000	299 000	1 500	29422 E
120	210	54	2.1	645 000	2 100 000	65 500	214 000	1 600	29324 E
	250	78	4	1 160 000	3 400 000	119 000	350 000	1 400	29424 E
130	225	58	2.1	740 000	2 450 000	75 500	250 000	1 500	29326 E
	270	85	4	1 330 000	3 900 000	135 000	400 000	1 200	29426 E
140	240	60	2.1	840 000	2 810 000	85 500	287 000	1 400	29328 E
	280	85	4	1 370 000	4 200 000	140 000	425 000	1 200	29428 E
150	250	60	2.1	870 000	2 900 000	89 000	296 000	1 400	29330 E
	300	90	4	1 580 000	4 900 000	162 000	500 000	1 100	29430 E
160	270	67	3	1 010 000	3 400 000	103 000	345 000	1 300	29332 E
	320	95	5	1 740 000	5 400 000	178 000	550 000	1 100	29432 E
170	280	67	3	1 050 000	3 500 000	107 000	355 000	1 200	29334 E
	340	103	5	1 680 000	5 800 000	171 000	595 000	1 000	29434 E
180	300	73	3	1 230 000	4 200 000	125 000	430 000	1 100	29336 E
	360	109	5	1 870 000	6 500 000	190 000	660 000	900	29436 E
190	320	78	4	1 370 000	4 700 000	140 000	480 000	1 100	29338 E
	380	115	5	2 100 000	7 450 000	215 000	760 000	850	29438 E
200	280	48	2	540 000	2 310 000	55 000	236 000	1 500	29240 E
	340	85	4	1 570 000	5 450 000	160 000	555 000	1 000	29340 E
	400	122	5	2 290 000	8 150 000	234 000	835 000	800	29440 E

Dimensions (mm)						Spacer Sleeve Dimensions (mm)		Abutment and Fillet Dimensions (mm)				Mass (kg) approx.
<i>d₁</i>	<i>D₁</i>	<i>B, B₁</i>	<i>B₂</i>	<i>C</i>	<i>A</i>	<i>d_{S1}</i> max.	<i>d_{S2}</i> max.	<i>d_a</i> ⁽¹⁾ min.	<i>D_a</i> max.	<i>D_b</i> min.	<i>r_a</i> max.	
114.5	89	27	38	20	38	67	67	90	108	133	1.5	2.55
121.5	93	29.5	40.5	22	42	72	72	100	115	143	2	3.2
131.5	102	31	43	24	44	78	78	105	125	153	2	3.9
138	107	33.5	46	25	47	83	83	115	132	163	2	4.65
148	114.5	35	48.5	27	50	89	89	120	140	173	2	5.55
134.5	112	24.5	35.5	19	50	91	91	115	135	153	1.5	2.7
156.5	124	37	51.5	28	54	95	95	130	150	183	2	6.55
139.5	118	24.5	35	19	52	97	97	120	140	158	1.5	2.83
165.5	129.5	39	54.5	29	56	100	100	135	157	193	2	7.55
152	128	26.2	38	20.8	58	107	107	130	150	173	1.5	3.6
185	144	43	59.5	33	62	111	111	150	175	214	2.5	10.3
169.5	142.5	30.3	43.5	24	64	117	117	145	165	193	2	5.25
200	157	47	64.5	36	69	121	129	165	190	234	2.5	13.3
187.5	156.5	34	48.5	27	70	130	130	160	180	214	2	7.3
215	171	50.5	69.5	38	74	132	142	180	205	254	3	16.6
203.5	168.5	37	53.5	28	76	141	143	170	195	229	2	8.95
235	185	54	74.5	42	81	143	153	195	225	275	3	21.1
216.5	179	38.5	54	30	82	148	154	185	205	244	2	10.4
244.5	195.5	54	74.5	42	86	153	162	205	235	285	3	22.2
224	190	38	54.5	29	87	158	163	195	215	254	2	10.8
266	209	58	81	44	92	164	175	220	250	306	3	27.3
243	203	42	60	33	92	169	176	210	235	275	2.5	14.3
278	224.5	60.5	84.5	46	99	175	189	230	265	326	4	32.1
252	214.5	42.2	60.5	32	96	178	188	220	245	285	2.5	14.8
310	243	37	99	50	104	—	—	245	285	—	4	43.5
270	227	46	65.5	36	103	189	195	235	260	306	2.5	19
330	255	39	105	52	110	—	—	260	300	—	4	52
288.5	244	49	69	38	110	200	211	250	275	326	3	23
345	271	41	111	55	117	—	—	275	320	—	4	60
266	236	15	46	24	108	—	—	235	255	—	2	8.55
306.5	257	53.5	75	41	116	211	224	265	295	346	3	28.5
365	280	43	117	59	122	—	—	290	335	—	4	69

Note (1) For heavy load applications, a *d_a* value should be chosen which is large enough to support the shaft washer rib.

Bore Diameter 220 – 420 mm

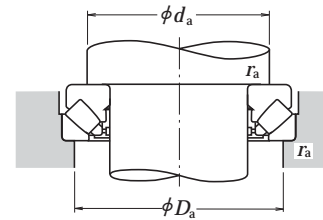
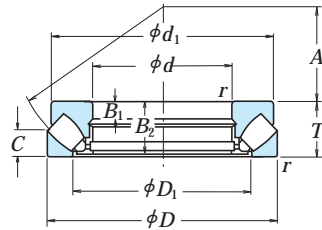

Dynamic Equivalent Load

$$P = 1.2F_r + F_a$$

Static Equivalent Load

$$P_0 = 2.8F_r + F_a$$

However, $F_r/F_a \leq 0.55$ must be satisfied.

Boundary Dimensions (mm)				Basic Load Ratings				Limiting Speeds (min ⁻¹) Oil	Bearing Numbers
d	D	T	r min.	C _a (N)	C _{0a} (kgf)	C _a (kgf)	C _{0a}		
220	300	48	2	560 000	2 500 000	57 000	255 000	1 400	29244 29344 29444
	360	85	4	1 340 000	5 200 000	137 000	530 000	950	
	420	122	6	2 350 000	8 650 000	240 000	880 000	800	
240	340	60	2.1	800 000	3 450 000	82 000	350 000	1 200	29248 29348 29448
	380	85	4	1 360 000	5 400 000	139 000	550 000	950	
	440	122	6	2 420 000	9 100 000	247 000	930 000	750	
260	360	60	2.1	855 000	3 850 000	87 500	395 000	1 200	29252 29352 29452
	420	95	5	1 700 000	6 800 000	173 000	695 000	800	
	480	132	6	2 820 000	10 700 000	287 000	1 090 000	710	
280	380	60	2.1	885 000	4 100 000	90 000	420 000	1 100	29256 29356 29456 29456 EM
	440	95	5	1 830 000	7 650 000	187 000	780 000	800	
	520	145	6	3 400 000	13 100 000	345 000	1 330 000	630	
	520	145	6	3 950 000	14 900 000	400 000	1 520 000	630	
300	420	73	3	1 160 000	5 150 000	118 000	525 000	950	29260 29360 29460
	480	109	5	2 190 000	9 100 000	224 000	925 000	710	
	540	145	6	3 500 000	13 700 000	355 000	1 390 000	630	
320	440	73	3	1 190 000	5 450 000	122 000	555 000	950	29264 29364 29464
	500	109	5	2 230 000	9 400 000	227 000	960 000	670	
	580	155	7.5	3 650 000	14 600 000	370 000	1 490 000	560	
340	460	73	3	1 230 000	5 750 000	125 000	590 000	900	29268 29368 29468
	540	122	5	2 640 000	11 200 000	269 000	1 140 000	630	
	620	170	7.5	4 400 000	17 400 000	450 000	1 780 000	530	
360	500	85	4	1 550 000	7 300 000	158 000	745 000	800	29272 29372 29472 29472 EM
	560	122	5	2 670 000	11 500 000	272 000	1 180 000	600	
	640	170	7.5	4 200 000	17 200 000	430 000	1 750 000	500	
	640	170	7.5	5 450 000	20 400 000	555 000	2 800 000	500	
380	520	85	4	1 620 000	7 800 000	165 000	795 000	800	29276 29376 29476
	600	132	6	3 300 000	14 500 000	335 000	1 480 000	560	
	670	175	7.5	4 800 000	19 500 000	490 000	1 990 000	480	
400	540	85	4	1 640 000	8 000 000	167 000	815 000	750	29280 29380 29480
	620	132	6	3 250 000	14 500 000	330 000	1 480 000	530	
	710	185	7.5	5 400 000	22 100 000	550 000	2 250 000	450	
420	580	95	5	2 010 000	9 800 000	205 000	1 000 000	670	29284 29384 29484
	650	140	6	3 500 000	15 700 000	355 000	1 600 000	500	
	730	185	7.5	5 650 000	23 500 000	575 000	2 400 000	450	

Dimensions (mm)						Abutment and Fillet Dimensions (mm)			Mass (kg) approx.
d ₁	D ₁	B ₁	B ₂	C	A	d _a ⁽¹⁾ min.	D _a max.	r _a max.	
285	254	15	46	24	117	260	275	2	9.2
335	280	29	81	41	125	285	315	3	33
385	308	43	117	58	132	310	355	5	74
325	283	19	57	30	130	285	305	2	16.5
355	300	29	81	41	135	300	330	3	35.5
405	326	43	117	59	142	330	375	5	79
345	302	19	57	30	139	305	325	2	18
390	329	32	91	45	148	330	365	4	48.5
445	357	48	127	64	154	360	405	5	105
365	323	19	57	30	150	325	345	2	19
410	348	32	91	46	158	350	390	4	52.5
480	384	52	140	68	166	390	440	5	132
480	380	52	140	70	166	410	445	5	134
400	353	21	69	38	162	355	380	2.5	30
450	379	37	105	50	168	380	420	4	74
500	402	52	140	70	175	410	460	5	140
420	372	21	69	38	172	375	400	2.5	32.5
470	399	37	105	53	180	400	440	4	77
555	436	55	149	75	191	435	495	6	175
440	395	21	69	37	183	395	420	2.5	33.5
510	428	41	117	59	192	430	470	4	103
590	462	61	164	82	201	465	530	6	218
480	423	25	81	44	194	420	455	3	51
525	448	41	117	59	202	450	495	4	107
610	480	61	164	82	210	485	550	6	228
580	474	61	164	83	210	495	550	6	220
496	441	27	81	42	202	440	475	3	52
568	477	44	127	63	216	480	525	5	140
640	504	63	168	85	230	510	575	6	254
517	460	27	81	42	212	460	490	3	55
590	494	44	127	64	225	500	550	5	150
680	536	67	178	89	236	540	610	6	306
553	489	30	91	46	225	490	525	4	72
620	520	48	135	68	235	525	575	5	170
700	556	67	178	89	244	560	630	6	323

Note (1) For heavy load applications, a d_a value should be chosen which is large enough to support the shaft washer rib.

Bore Diameter 440 – 500 mm

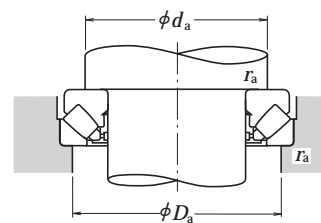
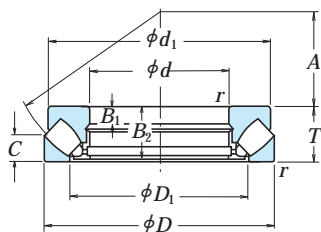

Dynamic Equivalent Load

$$P = 1.2F_r + F_a$$

Static Equivalent Load

$$P_0 = 2.8F_r + F_a$$

However, $F_r/F_a \leq 0.55$ must be satisfied.

Boundary Dimensions (mm)				Basic Load Ratings (N)				Limiting Speeds (min ⁻¹) Oil	Bearing Numbers
d	D	T	r min.	C _a	C _{0a}	C _a (kgf)	C _{0a} (kgf)		
440	600	95	5	2 030 000	10 100 000	207 000	1 030 000	670	29288 29388 29488 29488 EM
	680	145	6	3 750 000	16 700 000	380 000	1 710 000	480	
	780	206	9.5	6 550 000	27 200 000	665 000	2 770 000	400	
	780	206	9.5	8 000 000	31 500 000	815 000	3 250 000	400	
460	620	95	5	2 060 000	10 300 000	210 000	1 050 000	670	29292 29392 29492
	710	150	6	4 100 000	18 400 000	420 000	1 880 000	450	
	800	206	9.5	6 750 000	28 600 000	690 000	2 920 000	380	
480	650	103	5	2 370 000	12 100 000	241 000	1 240 000	600	29296 29396 29496
	730	150	6	4 150 000	19 000 000	425 000	1 940 000	450	
	850	224	9.5	7 200 000	31 000 000	730 000	3 150 000	360	
500	670	103	5	2 390 000	12 400 000	244 000	1 270 000	600	292/500 293/500 294/500
	750	150	6	4 350 000	20 400 000	445 000	2 080 000	450	
	870	224	9.5	7 850 000	33 000 000	800 000	3 350 000	340	

Dimensions (mm)						Abutment and Fillet Dimensions (mm)			Mass (kg) approx.
d ₁	D ₁	B ₁	B ₂	C	A	d _a ⁽¹⁾ min.	D _a max.	r _a max.	
575	508	30	91	49	235	510	545	4	77
645	548	49	140	70	245	550	600	5	190
745	588	74	199	100	260	595	670	8	407
710	577	74	199	101	257	605	675	8	402
592	530	30	91	46	245	530	570	4	80
666	567	51	144	72	257	575	630	5	210
765	608	74	199	100	272	615	690	8	420
624	556	33	99	55	259	555	595	4	97
690	590	51	144	72	270	595	650	5	215
810	638	81	216	108	280	645	730	8	545
645	574	33	99	55	268	575	615	4	100
715	611	51	144	74	280	615	670	5	220
830	661	81	216	107	290	670	750	8	560

Note (1) For heavy load applications, a d_a value should be chosen which is large enough to support the shaft washer rib.

ANGULAR CONTACT THRUST BALL BEARINGS

DOUBLE-DIRECTION ANGULAR CONTACT THRUST BALL BEARINGS	Bore Diameter 35 – 280mm	B238
ANGULAR CONTACT THRUST BALL BEARINGS FOR BALL SCREWS	Bore Diameter 15 – 60mm	B242

DESIGN, TYPE, AND FEATURES

DOUBLE-DIRECTION ANGULAR CONTACT THRUST BALL BEARINGS

Double-Direction Angular Contact Thrust Ball Bearings are specially designed high precision bearings for the main spindles of machine tools.

Compared with the Thrust Ball Bearings in the 511 Series, this type contains more balls of smaller diameter and has a contact angle of 60° . Consequently, the influence of centrifugal force is less and they can withstand higher speed and have higher rigidity.

Bearings in Series 20 and 29 have the same inner and outer diameters as the double-row cylindrical roller bearings in Series NN30 and NN49 respectively, and they are both used for high axial loads.

Their cages are machined brass.

There are the BTR, BAR Series of highly rigid angular contact ball bearings suitable for high speed that can be easily replaced by these double-direction angular contact ball bearings. For more details, please contact NSK.

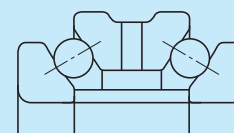

ANGULAR CONTACT THRUST BALL BEARINGS FOR BALL SCREWS

Bearings of this type were specially designed to support NSK Precision Ball Screws. They are usually used in combinations of more than two bearings and with a preload. Their contact angle is 60° . For more details, please refer to Catalog CAT. No. E1254 SUPER PRECISION BEARINGS.

Their cages are molded polyamide.

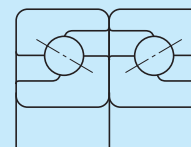

TOLERANCES AND RUNNING ACCURACY

DOUBLE-DIRECTION ANGULAR CONTACT THRUST BALL BEARINGS Table 1
ANGULAR CONTACT THRUST BALL BEARINGS FOR BALL SCREWS Table 2
 The limiting chamfer dimensions of bearings of both types conform to Table 8.9.1 (Page A78).

Table 1 Tolerances for Double-Direction Angular Contact Thrust Ball Bearings (Class 7 (1))

Table 1. 1 Tolerances for Bearing Bore and Height and Running Accuracy Units : μm

Nominal Bore Diameter <i>d</i> (mm)		Δ_{dmp}		Δ_{Ts}		K_{ia} (or K_{ea})	S_d	S_{ia} (or S_{ea})
over	incl.	high	low	high	low	max.	max.	max.
—	30	0	- 5	0	- 300	5	4	3
30	50	0	- 5	0	- 400	5	4	3
50	80	0	- 8	0	- 500	6	5	5
80	120	0	- 8	0	- 600	6	5	5
120	180	0	-10	0	- 700	8	8	5
180	250	0	-13	0	- 800	8	8	6
250	315	0	-15	0	- 900	10	10	6
315	400	0	-18	0	-1200	10	12	7

Note (1) Class 7 is NSK Standard.

Table 1. 2 Tolerances for Housing Washer Outside Diameter Units : μm

Nominal Outside Diameter <i>D</i> (mm)		Δ_{Ds}	
over	incl.	high	low
30	50	-25	- 41
50	80	-30	- 49
80	120	-36	- 58
120	180	-43	- 68
180	250	-50	- 79
250	315	-56	- 88
315	400	-62	- 98
400	500	-68	-108
500	630	-76	-120

Symbols in the tables are described on Page A59.

Table 2 Tolerances and Running Accuracy of Angular Contact Thrust Ball Bearings for Ball Screws (Class 7A (1))

Table 2. 1 Tolerances and Limits for Shaft and Housing Washer Units : μm

Nominal Bore Diameter <i>d</i> (mm)		Δ_{dmp}		Δ_{Bs} (or Δ_{Cs})		V_{Bs} (or V_{Cs})	K_{ia}	S_d	S_{ia}
over	incl.	high	low	high	low	max.	max.	max.	max.
10	18	0	- 4	0	-120	1.5	2.5	4	2.5
18	30	0	- 5	0	-120	1.5	3	4	2.5
30	50	0	- 6	0	-120	1.5	4	4	2.5
50	80	0	- 7	0	-150	1.5	4	5	2.5

Note (1) Class 7A is NSK Standard.

RECOMMENDED FITS

DOUBLE-DIRECTION ANGULAR CONTACT THRUST BALL BEARINGS

The shaft washer and shaft should be in soft contact with neither interference nor clearance, and the housing washer and housing bore should be loosely fitted. For a bearing arrangement with a double-row cylindrical roller bearing, the tolerances for the outside diameter should be f6 to produce a loose fit.

ANGULAR CONTACT THRUST BALL BEARINGS FOR BALL SCREWS

A tolerance of h5 is recommended for shafts and H6 for housing bores.

INTERNAL CLEARANCE AND PRELOAD

In order to produce an appropriate preload on bearings when they are mounted, the following axial internal clearances are recommended.

DOUBLE-ROW ANGULAR CONTACT THRUST BALL BEARINGS Clearance C7
ANGULAR CONTACT THRUST BALL BEARINGS FOR BALL SCREWS Clearance C10

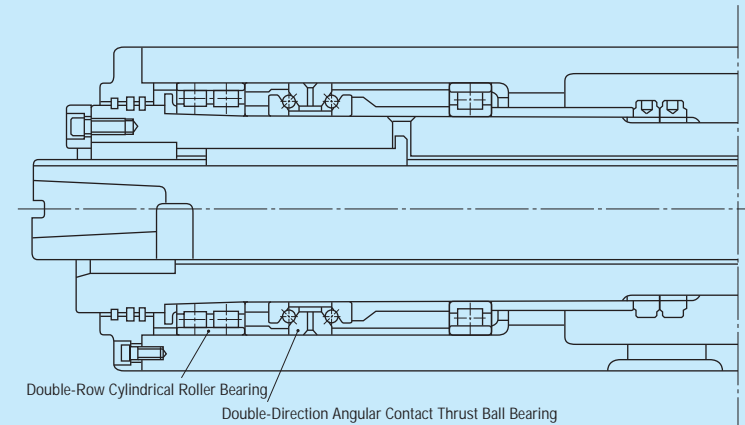

Example of Application of Double-Direction Angular Contact Thrust Ball Bearing (Main Spindle of Machine Tool)

Table 2. 2 Tolerances and Running Accuracy of Housing Washer Units : μm

Nominal Outside Diameter <i>D</i> (mm)		Δ_{Ds}		K_{ea}	S_{ea}
over	incl.	high	low	max.	max.
30	50	0	- 6	5	2.5
50	80	0	- 7	5	2.5
80	120	0	- 8	5	2.5

Bore Diameter 35 – 150 mm

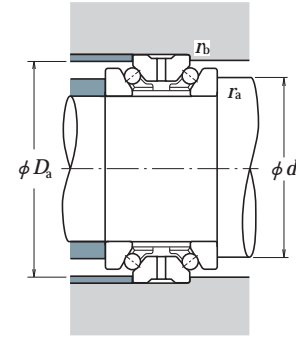
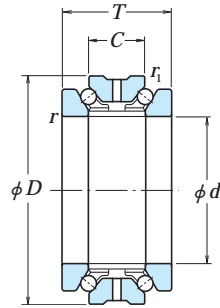

d	Boundary Dimensions (mm)					Basic Load Ratings				Limiting Speeds	
	D ⁽¹⁾	T	C	r _{min.}	r _{1 min.}	(N)	(kgf)	C _a	C _{0a}	Grease	Oil
35	62	34	17	1	0.6	22 800	53 500	2 330	5 450	10 000	11 000
40	68	36	18	1	0.6	23 600	59 000	2 410	6 050	9 000	10 000
45	75	38	19	1	0.6	26 300	67 500	2 680	6 900	8 000	9 000
50	80	38	19	1	0.6	27 200	74 000	2 780	7 550	7 000	8 000
55	90	44	22	1.1	0.6	33 500	94 000	3 450	9 550	6 300	6 900
60	95	44	22	1.1	0.6	35 000	102 000	3 550	10 400	5 900	6 500
65	100	44	22	1.1	0.6	36 000	110 000	3 700	11 300	5 500	6 100
70	110	48	24	1.1	0.6	49 500	146 000	5 050	14 900	5 000	5 600
75	115	48	24	1.1	0.6	50 000	152 000	5 100	15 500	4 800	5 300
80	125	54	27	1.1	0.6	59 000	181 000	6 000	18 500	4 400	4 900
85	130	54	27	1.1	0.6	59 500	189 000	6 050	19 300	4 200	4 700
90	140	60	30	1.5	1	78 500	246 000	8 000	25 100	4 000	4 400
95	145	60	30	1.5	1	79 500	256 000	8 100	26 100	3 800	4 200
100	140	48	24	1.1	0.6	55 000	196 000	5 600	20 000	3 800	4 200
	150	60	30	1.5	1	80 500	267 000	8 200	27 200	3 600	4 000
105	145	48	24	1.1	0.6	56 500	208 000	5 750	21 300	3 600	4 000
	160	66	33	2	1	91 500	305 000	9 350	31 000	3 400	3 800
110	150	48	24	1.1	0.6	57 000	215 000	5 800	21 900	3 500	3 900
	170	72	36	2	1	103 000	350 000	10 500	35 500	3 300	3 600
120	165	54	27	1.1	0.6	66 500	256 000	6 800	26 100	3 200	3 600
	180	72	36	2	1	106 000	375 000	10 800	38 000	3 000	3 400
130	180	60	30	1.5	1	79 500	315 000	8 100	32 500	3 000	3 300
	200	84	42	2	1	134 000	455 000	13 600	46 500	2 800	3 100
140	190	60	30	1.5	1	91 500	365 000	9 350	37 500	2 800	3 100
	210	84	42	2	1	145 000	525 000	14 800	53 500	2 600	2 900
150	210	72	36	2	1	116 000	465 000	11 800	47 500	2 500	2 800
	225	90	45	2.1	1.1	172 000	620 000	17 500	63 500	2 400	2 700

Note (1) Outside tolerance is f6.

Bearing Numbers	Abutment and Fillet Dimensions (mm)				Mass (kg) approx.
	d _a	D _a	r _{a max.}	r _{b max.}	
35 TAC 20X+L	46	58	1	0.6	0.375
40 TAC 20X+L	51	63	1	0.6	0.460
45 TAC 20X+L	57	70	1	0.6	0.580
50 TAC 20X+L	62	75	1	0.6	0.625
55 TAC 20X+L	69	84	1	0.6	0.945
60 TAC 20X+L	74	89	1	0.6	1.000
65 TAC 20X+L	79	94	1	0.6	1.080
70 TAC 20X+L	87	104	1	0.6	1.460
75 TAC 20X+L	92	109	1	0.6	1.550
80 TAC 20X+L	99	117	1	0.6	2.110
85 TAC 20X+L	104	122	1	0.6	2.210
90 TAC 20X+L	110	131	1.5	1	2.930
95 TAC 20X+L	115	136	1.5	1	3.050
100 TAC 29X+L	117	134	1	0.6	1.950
100 TAC 20X+L	120	141	1.5	1	3.200
105 TAC 29X+L	122	139	1	0.6	2.040
105 TAC 20X+L	127	150	2	1	4.100
110 TAC 29X+L	127	144	1	0.6	2.120
110 TAC 20X+L	134	158	2	1	5.150
120 TAC 29X+L	139	157	1	0.6	2.940
120 TAC 20X+L	144	168	2	1	5.500
130 TAC 29X+L	150	170	1.5	1	3.950
130 TAC 20X+L	160	187	2	1	8.200
140 TAC 29D+L	158	182	1.5	1	4.200
140 TAC 20D+L	167	198	2	1	8.750
150 TAC 29D+L	172	200	2	1	6.600
150 TAC 20D+L	178	213	2	1	10.700

Remarks Nominal bearing bore and outside diameters for 20X · 20D and 29X · 29D bearing series are the same as those for the NN30 and NNU49 · NN49 bearing series respectively.

Bore Diameter 160 – 280 mm

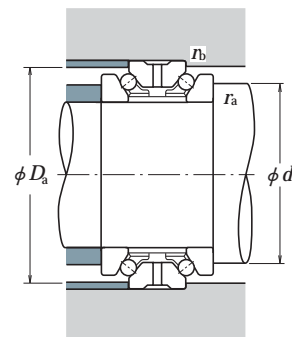
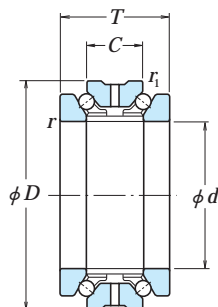

d	Boundary Dimensions (mm)					Basic Load Ratings				Limiting Speeds	
	D ⁽¹⁾	T	C	r _{min.}	r _{1 min.}	(N)	(kgf)		Grease	Oil	
						C _a	C _{0a}	C _a	C _{0a}		
160	220	72	36	2	1	118 000	490 000	12 100	50 000	2 400	2 700
	240	96	48	2.1	1.1	185 000	680 000	18 900	69 500	2 300	2 500
170	230	72	36	2	1	120 000	520 000	12 300	53 000	2 300	2 500
	260	108	54	2.1	1.1	218 000	810 000	22 200	82 500	2 100	2 400
180	250	84	42	2	1	158 000	655 000	16 100	67 000	2 100	2 400
	280	120	60	2.1	1.1	281 000	1 020 000	28 700	104 000	2 000	2 200
190	260	84	42	2	1	161 000	695 000	16 400	71 000	2 000	2 300
	290	120	60	2.1	1.1	285 000	1 060 000	29 000	108 000	1 900	2 100
200	280	96	48	2.1	1.1	204 000	855 000	20 800	87 000	1 900	2 100
	310	132	66	2.1	1.1	315 000	1 180 000	32 000	120 000	1 800	2 000
220	300	96	48	2.1	1.1	210 000	930 000	21 400	95 000	1 800	2 000
240	320	96	48	2.1	1.1	213 000	980 000	21 700	100 000	1 700	1 800
260	360	120	60	2.1	1.1	315 000	1 390 000	32 000	141 000	1 500	1 700
280	380	120	60	2.1	1.1	320 000	1 470 000	32 500	150 000	1 400	1 600

Note (1) Outside tolerance is f6.

Bearing Numbers	Abutment and Fillet Dimensions (mm)				Mass (kg) approx.
	d _a	D _a	r _{a max.}	r _{b max.}	
160 TAC 29D+L	182	210	2	1	7.000
160 TAC 20D+L	191	228	2	1	13.000
170 TAC 29D+L	192	219	2	1	7.350
170 TAC 20D+L	206	245	2	1	17.700
180 TAC 29D+L	207	238	2	1	10.700
180 TAC 20D+L	220	264	2	1	23.400
190 TAC 29D+L	217	247	2	1	11.200
190 TAC 20D+L	230	274	2	1	24.400
200 TAC 29D+L	230	267	2	1	15.700
200 TAC 20D+L	245	291	2	1	31.500
220 TAC 29D+L	250	287	2	1	17.000
240 TAC 29D+L	270	307	2	1	18.300
260 TAC 29D+L	300	344	2	1	31.500
280 TAC 29D+L	320	364	2	1	33.500

Remarks Nominal bearing bore and outside diameters for 20X · 20D and 29X · 29D bearing series are the same as those for the NN30 and NNU49 · NN49 bearing series respectively.

Bore Diameter 15 – 60 mm

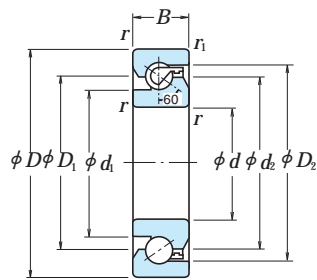

Double-Row Combination

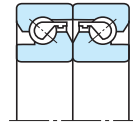

DF

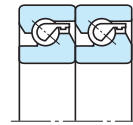

DT

Three-Row Combination

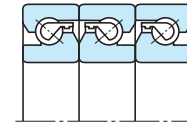

DFD

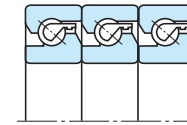

DTD

Four-Row Combination

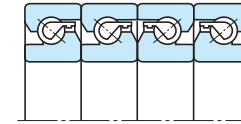

DFF

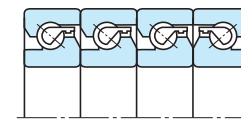

DFT

Dynamic Equivalent Load

$$P_a = X F_r + Y F_a$$

Combination	Two Rows		Three Rows		Four Rows				
	DF	DT	DFD	DTD	DFT	DFD	DFT		
$F_a/F_r \leq e$	X	1.9	—	1.43	2.33	—	1.17	2.33	2.53
	Y	0.55	—	0.77	0.35	—	0.89	0.35	0.26
$F_a/F_r > e$	X	0.92	0.92	0.92	0.92	0.92	0.92	0.92	0.92
	Y	1	1	1	1	1	1	1	1

Boundary Dimensions (mm)					Dimensions (mm)				Limiting Speeds ⁽¹⁾ (min ⁻¹)		Bearing Numbers	Mass (kg) approx.
d	D	B	r min.	r ₁ min.	d ₁	d ₂	D ₁	D ₂	Grease	Oil		
15	47	15	1	0.6	27.2	34	34	39.6	6 000	8 000	15 TAC 47B	0.144
17	47	15	1	0.6	27.2	34	34	39.6	6 000	8 000	17 TAC 47B	0.144
20	47	15	1	0.6	27.2	34	34	39.6	6 000	8 000	20 TAC 47B	0.135
25	62	15	1	0.6	37	45	45	50.7	4 500	6 000	25 TAC 62B	0.252
30	62	15	1	0.6	39.5	47	47	53.2	4 300	5 600	30 TAC 62B	0.224
35	72	15	1	0.6	47	55	55	60.7	3 600	5 000	35 TAC 72B	0.31
40	72	15	1	0.6	49	57	57	62.7	3 600	4 800	40 TAC 72B	0.275
	90	20	1	0.6	57	68	68	77.2	3 000	4 000	40 TAC 90B	0.674
45	75	15	1	0.6	54	62	62	67.7	3 200	4 300	45 TAC 75B	0.27
	100	20	1	0.6	64	75	75	84.2	2 600	3 600	45 TAC 100B	0.842
50	100	20	1	0.6	67.5	79	79	87.7	2 600	3 400	50 TAC 100B	0.778
55	100	20	1	0.6	67.5	79	79	87.7	2 600	3 400	55 TAC 100B	0.714
	120	20	1	0.6	82	93	93	102.2	2 200	3 000	55 TAC 120B	1.23
60	120	20	1	0.6	82	93	93	102.2	2 200	3 000	60 TAC 120B	1.16

Note (1) These values apply when the standard preload (C10) is used.

Basic Load Ratings C _a						Limiting Axial Load					
Sustained by one row DF (N) (kgf)		Sustained by two rows DT, DFD, DFF (N) (kgf)		Sustained by three rows DTD, DFT (N) (kgf)		Sustained by one row DF (N) (kgf)		Sustained by two rows DT, DFD, DFF (N) (kgf)		Sustained by three rows DTD, DFT (N) (kgf)	
21 900	2 240	35 500	3 650	47 500	4 850	26 600	2 710	53 000	5 400	79 500	8 150
21 900	2 240	35 500	3 650	47 500	4 850	26 600	2 710	53 000	5 400	79 500	8 150
21 900	2 240	35 500	3 650	47 500	4 850	26 600	2 710	53 000	5 400	79 500	8 150
28 500	2 910	46 500	4 700	61 500	6 250	40 500	4 150	81 500	8 300	122 000	12 500
29 200	2 980	47 500	4 850	63 000	6 400	43 000	4 400	86 000	8 800	129 000	13 200
31 000	3 150	50 500	5 150	67 000	6 850	50 000	5 100	100 000	10 200	150 000	15 300
31 500	3 250	51 500	5 250	68 500	7 000	52 000	5 300	104 000	10 600	157 000	16 000
59 000	6 000	95 500	9 750	127 000	13 000	89 500	9 150	179 000	18 300	269 000	27 400
33 000	3 350	53 500	5 450	71 000	7 250	57 000	5 800	114 000	11 600	170 000	17 400
61 500	6 300	100 000	10 200	133 000	13 600	99 000	10 100	198 000	20 200	298 000	30 500
63 000	6 400	102 000	10 400	136 000	13 800	104 000	10 600	208 000	21 200	310 000	32 000
63 000	6 400	102 000	10 400	136 000	13 800	104 000	10 600	208 000	21 200	310 000	32 000
67 500	6 850	109 000	11 200	145 000	14 800	123 000	12 600	246 000	25 100	370 000	37 500
67 500	6 850	109 000	11 200	145 000	14 800	123 000	12 600	246 000	25 100	370 000	37 500

NEEDLE ROLLER BEARINGS

CAGE & NEEDLE ROLLER ASSEMBLIES Inscribed Circle Diameter 5 – 100mm..... B252

Cage & Needle Roller Assemblies for Connecting Rod Inscribed Circle Diameter 12 – 30mm..... B256

DRAWN CUP NEEDLE ROLLER BEARINGS

With Cage Inscribed Circle Diameter 4 – 55mm..... B258

Full Complement Type Inscribed Circle Diameter 8 – 55mm..... B258

SOLID NEEDLE ROLLER BEARINGS Inscribed Circle Diameter 9 – 390mm..... B264

THRUST NEEDLE ROLLER BEARINGS Bore Diameter 10 – 100mm..... B274

CAM FOLLOWERS Outside Diameter 16 – 90mm ... B276

ROLLER FOLLOWERS Bore Diameter 5 – 50mm..... B278

DESIGN AND TYPES

For needle roller bearings, there are many designs and types bearings. Catalog

Specified catalog, NSK Needle Roller Bearings CAT.No.E1419 lists bearings shown in Table 1. Representative examples selected from them, are shown in this catalog. (shown with ■ in Table 1) For details, please refer individual specified catalog.

For bearing selection, please contact NSK.

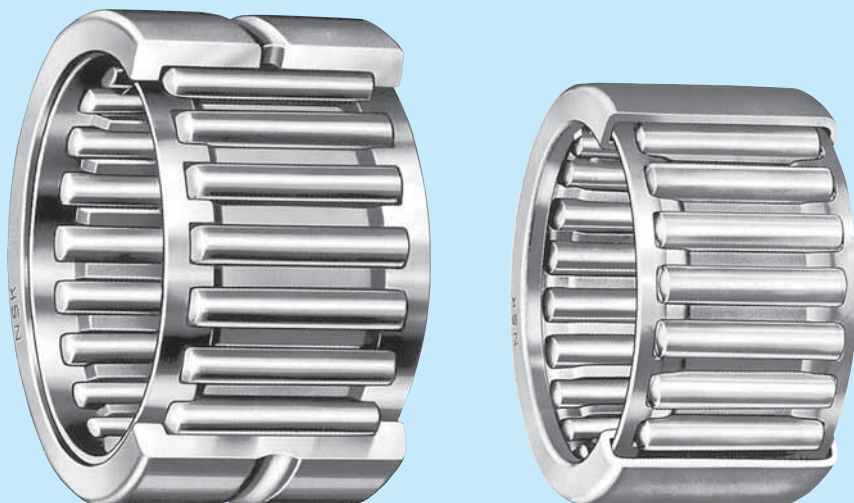

Table1 Types of Needle Roller Bearings

Cage & Needle Roller Assemblies	FWJ, FWF WJ		FBN, FBNP WJC FWJC	
Drawn Cup Needle Roller Bearings	FJ, FJH J, JH		MFJ, MFJH MJ, MJH	
	F, FH B, BH		MF, MFH M, MH	
Solid Needle Roller Bearings	RNA 48 RNA 49 RNA 59 RNA 69 HJ		RLM	
			RNAF	
Thrust Needle Roller Bearings	FNTA NTA		FTRA TRA	
Thrust raceway washers	FB		FTRB TRB	
Needle Rollers	FTRC TRC		FTRD TRD	
	FTRF TRF			
Cam Followers	FCR FCJ		FCRS FCJS	
Roller Followers	YCR YCRS		FYCR FYCJ	
Needle Roller Bearings For Universal Joints	ZY		NSA	
Drawn Cup Roller Clutches	RC		FC	
	RCB		FCB	

Table 2 is applicable to standard drawn cup needle roller bearings (metric series), and Table 3 shows tolerance of roller inscribed circle diameter based on ISO Standards. For bearings assured by ISO Standards, please order by adding symbol of "-1" at the end of bearing number.

Table 2 Inspection Gauge Dimensions (General Metric) of Drawn Cup Needle Roller Bearings.
(FJ, FJH, MFJ, MFJH)
(F, FH, MF, MFH)

Nominal Roller Inscribed Circle Diameter, F_w	Bore Diameter of Ring Gauge	Units mm	
		Plug Gauge	
		GO Gauge	NO-GO Gauge
4	7.996	4.023	4.048
5	8.996	5.023	5.048
6	9.996	6.028	6.053
7	10.995	7.031	7.056
8	11.995	8.031	8.056
9	12.995	9.031	9.056
10	13.995	10.031	10.056
12	15.995	12.031	12.056
FH 12	17.995	12.031	12.056
13	18.993	13.034	13.059
14	19.993	14.034	14.059
15	20.993	15.034	15.059
16	21.993	16.034	16.059
17	22.972	17.013	17.038
18	23.972	18.013	18.038
20	25.972	20.013	20.038
22	27.972	22.013	22.038
25	31.967	25.013	25.038
28	34.967	28.013	28.038
30	36.967	30.013	30.038
35	41.967	35.013	35.043
40	46.967	40.013	40.043
45	51.961	45.013	45.043
50	57.961	50.013	50.043
55	62.961	55.013	55.043

Table 3 Ring Gauge of Drawn Cup Needle Roller Bearings and Tolerance of Roller Inscribed Circle Diameter (ISO Standards)
(FJ, FJH, MFJ and MFJH)
(F, FH, MF and MFH)

Nominal Roller Inscribed Circle Diameter, F_w	Bore Diameter of Ring Gauge	Units mm	
		Tolerance for Roller Inscribed Circle Diameter, F_{wmin} (1)	
		min.	max.
4	7.984	4.010	4.028
5	8.984	5.010	5.028
6	9.984	6.010	6.028
7	10.980	7.013	7.031
8	11.980	8.013	8.031
H 8	13.980	8.013	8.031
9	12.980	9.013	9.031
H 9	14.980	9.013	9.031
10	13.980	10.013	10.031
H 10	15.980	10.013	10.031
12	15.980	12.016	12.034
H 12	17.980	12.016	12.034
13	18.976	13.016	13.034
14	19.976	14.016	14.034
15	20.976	15.016	15.034
16	21.976	16.016	16.034
17	22.976	17.016	17.034
18	23.976	18.016	18.034
20	25.976	20.020	20.041
22	27.976	22.020	22.041
25	31.972	25.020	25.041
28	34.972	28.020	28.041
30	36.972	30.020	30.041
35	41.972	35.025	35.050
40	46.972	40.025	40.050
45	51.967	45.025	45.050
50	57.967	50.025	50.050
55	62.967	55.030	55.060

Remarks This is the gauge dimension for inspection of minimum diameter, F_{wmin} , of roller inscribed circle diameter.

Note (1) When using a cylinder instead of an inner ring, F_{wmin} is the diameter of the cylinder at which the internal clearance is zero in at least one radial direction. (F_{wmin} is the minimum diameter of each inscribed circle diameter where deviation is assumed.)

Remarks To measure the roller inscribed circle diameter, use the following plug gauges:
GO gauge: The same dimensions as the minimum tolerance of the roller inscribed circle diameter F_{wmin} .
NO-GO gauge: The dimensions should be the maximum tolerance of roller inscribed circle diameter, F_{wmin} , plus 0.002 mm.

DIMENSIONAL ACCURACY · RUNNING ACCURACY

DRAWN CUP NEEDLE ROLLER BEARINGS

The correct form and dimensional accuracy of outer ring of drawn cup needle roller bearing is achieved only by press fitting into proper housing with appropriate interference. Therefore, roller inscribed circle diameter is measured after press fitted into a standard ring gauge.

The dimension of ring gauge and tolerance of roller inscribed circle diameter are shown in Tables 2 and 3.

SOLID NEEDLE ROLLER BEARINGS Table 8. 2 (A60-63 pages)

Tolerance of roller inscribed circle diameter for solid needle roller bearings without inner rings are shown in Table 4.

Table 4 Inscribed Circle Diameter for Metric Solid Needle Roller Bearings Units μm

Nominal Inscribed Circle Diameter, F_w (mm)		Deviation (F6) of Minimum Diameter, F_{wmin} , of Roller Inscribed Circle Diameter $F_{wmin}^{(1)}$ ΔF_{wmin}	
over	incl.	high	low
6	10	+ 22	+13
10	18	+ 27	+16
18	30	+ 33	+20
30	50	+ 41	+25
50	80	+ 49	+30
80	120	+ 58	+36
120	180	+ 68	+43
180	250	+ 79	+50
250	315	+ 88	+56
315	400	+ 98	+62
400	500	+108	+68

Note (1) When using a cylinder instead of an inner ring, F_{wmin} is the diameter of the cylinder at which the internal clearance is zero in at least one radial direction. (F_{wmin} is the minimum diameter of each inscribed circle diameter where deviation is assumed.)

CAM FOLLOWERS · ROLLER FOLLOWERS Table 8. 2 (A60-63 pages)

The tolerance zone class of stud diameter d of cam followers is **h7**, and the tolerance of assembled width of inner ring of roller followers is shown in bearing table.

These tolerances are applied to the bearings before surface treatment.
Cam Follower Dimensional Tolerances is always applied to the bearing before surface treatment.

RECOMMENDED FITTING AND BEARING INTERNAL CLEARANCE

CAGE & NEEDLE ROLLER ASSEMBLIES

Recommended fitting of cage & roller under typical operating condition is shown in Table 5. By combining cage & roller, shaft, and housing, appropriate radial internal clearance is obtained. However, the fitting and the radial internal clearance of cage & roller for connecting rod should be determined by the type of engine, characteristic, and driving condition etc.. For details, please refer to specified catalog.

Table 5 Fitting Tolerances for Shafts and Housing Bores

Operating Conditions	Fitting Tolerance		housing bore
	shaft		
	$F_w \leq 50 \text{ mm}$	$F_w > 50 \text{ mm}$	
High Accuracy, Oscillating Motion	js5 (j5)	h5	G6
Normal	h5	g5	
High Temperature, Large Shaft Deflection and Mounting Error of Bearings	f6		

DRAWN CUP NEEDLE ROLLER BEARINGS

For FJ, FJH, and MFJH types and F, FH, and MFH types, if tolerance of fitting such as shaft:h6, and housing bore:N7 (in case of thick steel housing), are applied under general operating condition, appropriate radial internal clearance is obtained. In case that outer ring rotation, the fitting of shaft : **f6**, housing bore : **R7**, and light alloy housing or steel housing of less than **6mm** thickness, the housing bore should be smaller than N7 by 0.013 – 0.025 **mm**.

SOLID NEEDLE ROLLER BEARINGS

Recommended fitting for solid needle roller bearings with inner rings

Table 9. 2 (Page A84)

Table 9. 4 (Page A85)

Internal clearance of solid needle roller bearings with inner rings

Table 9. 14 (Page A91)

However, for needle roller bearing of wider bearing width, and with long needle rollers, bearings with CN clearance are not necessarily common, but large clearance is selected frequently. For the solid needle roller bearing without inner ring, it is possible to select radial internal clearance shown in Table 6 by selecting tolerance class of shaft, which is fitting to the bearing.

Table 6 Fitting Tolerances and Radial Internal clearance of Shafts Assembled with Solid Needle Roller Bearings without Inner Rings

Nominal Roller Inscribed Circle Diameter F_w (mm)		C2	CN	C3	C4
over	incl.				
6	180	k5	g5	f6	e6
180	315	j6	f6	e6	d6
315	490	h6	e6	d6	c6

THRUST NEEDLE ROLLER BEARINGS

Recommended Fitting of Thrust Needle Roller Bearings and Thrust Raceway are shown in Table 7.

Table 7 Recommended Fitting of Thrust Needle Roller Bearings and Thrust Raceway

Units mm

Classification	Type	Cage or raceway guide	Tolerance class or dimension tolerance	
			Shaft	Housing bore
Thrust Needle Bearing Cage & Needle Roller Assemblies	FNTA	Bore	h8	D_c (1)+over 1.0
		Outside	—	H10
Thrust Bearing Rings	FTRA to FTRE	Bore	h8	D_c (1)+over 1.0
		Outside	—	H10

Note (1) D_c represents outside diameter of the cage.

Remarks If the cage is guided by outside diameter, to prevent the wear of housing bore, it is necessary to harden the surface at least.

CAM FOLLOWERS · ROLLER FOLLOWERS

The recommended fittings for the mounting area of cam follower studs are shown in Table 8. Recommended shaft fittings of roller follower are shown in Table 9.

Since cam followers are used with cantilevered mounting, they should be fixed with little clearance of the fitting surface as much as possible.

Since a roller follower is generally used with outer ring rotation, the fitting with shaft is transition or loose fit. In case that heavy loads impose to the roller follower, it is recommended to use the shaft of quench hardening treatment, and with tight fit.

For the details, please refer to specified catalog.

Table 8 Recommended Fitting for Stud Mounting Part of Cam Followers

Type	Fitting Tolerance of Mounting Hole
FCR, FCRS FCJ, FCJS	JS7 (J7)

Table 9 Recommended Shaft Fittings of Roller Followers

Load	Fitting Tolerance of Shaft
Light Load/Normal Load	g6 or h6
Heavy Load	k6

SHAFT AND HOUSING SPECIFICATIONS

The specification of shaft and housing for radial needle roller bearings, which are used under general operating condition, is shown in Table 10.

Table 10 Shaft and housing Specifications of Radial Needle Roller Bearings (Cage & Needle Roller Assemblies/Drawn Cup Bearings/Solid Bearings)

Category	Shaft		Housing Bore	
	Raceway Surface	Fitting Surface	Raceway Surface	Fitting Surface
Out-of-Roundness Tolerance	$\frac{IT3}{2}$	$\frac{IT3}{2}$ to $\frac{IT4}{2}$	$\frac{IT3}{2}$	$\frac{IT4}{2}$ to $\frac{IT5}{2}$
Cylindricity Tolerance	$\frac{IT3}{2}$	$\frac{IT3}{2}$ to $\frac{IT4}{2}$	$\frac{IT3}{2}$	$\frac{IT4}{2}$ to $\frac{IT5}{2}$
Roughness R_a (μm)	0.4	0.8	0.8	1.6
Hardness	HRC58 to 64 Appropriate depth of hardening layer required	—	HRC58 to 64 Appropriate depth of hardening layer required	—

- Remarks**
- For the specification of shaft and housing of cage & needle roller assembly for connecting rod, please refer to specified catalog.
 - These are general recommendation by radius method. For the value of standard tolerance (IT), please refer to Appendix 11 (page C22)

Specifications of Thrust Bearings Raceway Surface are shown in Table 11.

Table 11 Specifications of Thrust Bearings Raceway Surface

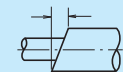
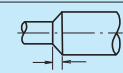
Squareness A	0.5/1000 incl (mm/mm)	
Squareness B	1.0/1000 incl (mm/mm)	
Roughness R_a (μm)	0.4	—
Hardness	HRC58 to 64 (HRC60 to 64 is favorable)	—

LIMITING INCLINATION ANGLES

The limiting inclination angle of radial needle roller bearing under general load condition is 0.001 radian (3.4') approximately. For the detail, please refer to specified catalog.

PERMISSIBLE TRACK LOAD

The permissible load of the track is determined by compression strength or hardness. The permissible load of the track shown in the bearing table is value of a track made of steel with a hardness of HRC40. Table 12 indicates the permissible load coefficient of the track for each hardness.

The permissible load of the track for each hardness can be obtained by multiplying the permissible load coefficient of the track corresponding to each hardness.

PRE-PACKED GREASE

The cam follower/roller follower with a seal is pre-lubricated with lithium soap-based grease. The range of operating temperature is -10 to $+110^\circ\text{C}$. For the cam follower/roller follower without seal, please lubricate with suitable lubricant.

MAXIMUM PERMISSIBLE LOAD AND MAXIMUM CLAMP TORQUE OF CAM FOLLOWERS.

The maximum radial Load that the cam follower can carry is determined by the bearing strength and shear strength of the stud rather than the Load rating for neele bearings. This value is given in the bearing table as the maximum permissible Load.

Since the stud of the cam follower receives bending stress and tensile stress from the bearing Load, the screw clamp torque should not exceed the value shown in the bearing table.

LIMITING SPEED

The limiting speeds of bearings are shown in bearing tables. However, depending on load condition of the bearing, the limiting speeds are necessary to compensate. Also, improvement of lubrication method allows to take higher limiting speed. For the detail, please refer to A37 page.

FWF • FWJ

Inscribed Circle Diameter 5 – 22 mm

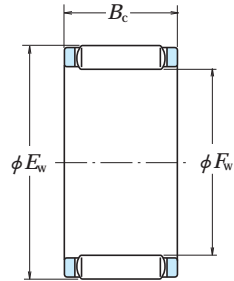

Boundary Dimensions (mm)			Basic Load Ratings (N) (kgf)				Limiting Speeds (min ⁻¹)	
<i>F_W</i>	<i>E_W</i>	<i>B_C</i> ^{-0.2 -0.55}	<i>C_r</i>	<i>C_{0r}</i>	<i>C_r</i>	<i>C_{0r}</i>	Grease	Oil
5	8	8	2 330	1 860	237	189	60 000	95 000
6	9	8	2 200	1 780	224	182	48 000	75 000
	9	10	3 350	3 050	340	310	48 000	75 000
7	10	8	2 840	2 560	290	261	40 000	67 000
	10	10	3 650	3 550	375	360	40 000	67 000
8	11	10	3 950	4 000	400	410	34 000	56 000
	11	13	4 750	5 150	485	525	34 000	56 000
9	12	10	3 750	3 850	380	395	30 000	50 000
	12	13	5 100	5 750	520	585	30 000	50 000
10	13	10	3 950	4 300	405	435	28 000	45 000
	13	13	5 400	6 350	550	650	28 000	45 000
	14	13	6 500	6 750	660	690	28 000	45 000
12	15	10	4 350	5 100	445	520	22 000	36 000
	15	13	5 950	7 600	605	775	22 000	36 000
	16	13	7 350	8 350	750	850	22 000	38 000
14	18	10	6 750	7 750	690	790	19 000	32 000
	18	13	8 050	9 750	820	995	19 000	32 000
	20	17	13 400	14 600	1 370	1 490	20 000	32 000
15	19	10	7 050	8 400	720	855	18 000	28 000
	19	13	8 400	10 500	860	1 070	18 000	28 000
	21	17	13 400	14 800	1 370	1 510	19 000	30 000
16	20	10	7 350	9 000	750	920	17 000	26 000
	20	13	8 800	11 300	895	1 150	17 000	26 000
	22	17	14 700	16 900	1 500	1 720	17 000	28 000
17	21	10	7 650	9 650	780	985	16 000	26 000
	21	13	10 200	14 000	1 040	1 420	16 000	26 000
	23	17	15 100	17 800	1 540	1 810	16 000	26 000
18	22	10	7 900	10 300	805	1 050	15 000	24 000
	22	13	9 450	12 900	965	1 310	15 000	24 000
	24	17	17 400	21 600	1 770	2 210	15 000	24 000
20	24	10	8 000	10 700	815	1 090	13 000	20 000
	24	13	9 700	13 700	990	1 400	13 000	20 000
	26	17	18 000	23 200	1 830	2 370	14 000	22 000
22	26	10	8 600	12 200	880	1 240	12 000	19 000
	26	13	10 300	15 300	1 050	1 560	12 000	19 000
	28	17	17 300	22 700	1 760	2 310	12 000	20 000

Bearing Numbers	Mass (g)
	approx.
* FBNP-588	1.0
* FBNP-698	1.2
* FBNP-6910	1.5
* FBNP-7108	1.3
* FBNP-71010	1.6
* FBNP-81110	1.8
* FBNP-81113	2.6
* FBNP-91210	2.0
* FBNP-91213	2.6
FBN-101310	2.2
FBN-101313	2.9
FWF-101413	4.0
FBN-121510	2.6
FBN-121513	3.4
FWF-121613	4.6
FWF-141810	4.1
FWF-141813	5.3
FWF-142017	11
FWF-151910	4.3
FWF-151913	5.6
FWF-152117	12
FWF-162010	4.6
FWF-162013	6.0
FWF-162217	12
FWF-172110	4.8
FWJ-172113	6.3
FWF-172317	14
FWF-182210	5.1
FWF-182213	6.6
FWJ-182417	14
FWF-202410	5.6
FWF-202413	7.3
FWJ-202617	15
FWF-222610	6.1
FWF-222613	7.9
FWF-222817	16

Note (*) These bearings have polyamide cages. The maximum permissible operating temperature for these bearings is 100 °C for continued operation and 120 °C for short periods.

FWF • FWJ

Inscribed Circle Diameter 25 – 100 mm

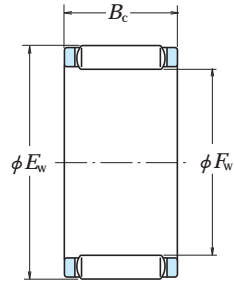

Boundary Dimensions (mm)			Basic Load Ratings				Limiting Speeds	
F_w	E_w	$B_c^{-0.2-0.55}$	C_r (N)	C_{0r} (kgf)	C_r	C_{0r}	Grease	Oil
25	29	10	9 350	14 100	950	1 440	10 000	17 000
	29	13	11 300	18 000	1 150	1 830	10 000	17 000
	31	17	19 200	26 800	1 950	2 740	10 000	17 000
28	33	13	13 700	20 400	1 400	2 080	9 500	15 000
	33	17	17 600	28 300	1 800	2 890	9 500	15 000
	34	17	19 900	29 100	2 020	2 970	9 500	15 000
30	35	13	14 000	21 600	1 430	2 200	8 500	14 000
	35	17	18 700	31 500	1 910	3 200	8 500	14 000
	37	20	26 000	38 000	2 650	3 850	9 000	14 000
32	37	13	15 100	24 400	1 540	2 480	8 000	13 000
	37	17	18 500	31 500	1 880	3 200	8 000	13 000
	39	20	27 300	41 000	2 780	4 200	8 500	13 000
35	40	13	14 900	24 600	1 520	2 500	7 500	12 000
	40	17	20 500	37 000	2 090	3 750	7 500	12 000
	42	20	30 000	47 500	3 050	4 850	7 500	12 000
40	45	17	21 000	40 000	2 150	4 050	6 300	10 000
	45	27	32 000	68 000	3 250	6 900	6 300	10 000
	48	25	40 500	66 500	4 150	6 800	6 700	10 000
45	50	17	21 600	43 000	2 200	4 350	5 600	9 000
	50	27	34 000	77 500	3 500	7 900	5 600	9 000
	53	25	44 000	77 000	4 500	7 850	5 600	9 500
50	55	20	26 900	59 000	2 750	6 050	5 000	8 000
	55	27	35 000	83 000	3 600	8 450	5 000	8 000
	58	25	48 500	90 500	4 950	9 200	5 300	8 500
55	61	20	31 000	64 000	3 150	6 500	4 500	7 500
	61	30	47 000	109 000	4 750	11 100	4 500	7 500
	63	25	50 000	97 500	5 100	9 950	4 800	7 500
60	66	20	33 000	71 500	3 350	7 300	4 300	6 700
	66	30	50 000	122 000	5 100	12 400	4 300	6 700
	68	25	52 000	105 000	5 300	10 700	4 300	6 700
65	73	30	61 000	132 000	6 200	13 400	4 000	6 300
	70	30	63 000	140 000	6 400	14 300	3 600	6 000
75	83	30	65 000	151 000	6 650	15 400	3 400	5 600
	88	30	69 000	166 000	7 050	17 000	3 200	5 000
85	93	30	71 000	176 000	7 250	17 900	3 000	4 800
	90	30	70 000	177 000	7 150	18 000	2 800	4 500
95	103	30	69 500	177 000	7 100	18 100	2 600	4 300
	100	108	75 500	201 000	7 700	20 500	2 400	4 000

Bearing Numbers	Mass (g)
	approx.
FWF-252910	6.9
FWF-252913	8.9
FWF-253117	18
FWF-283313	13
FWF-283317	16
FWF-283417	20
FWF-303513	14
FWF-303517A	18
FWF-303720	30
FWF-323713	14
FWJ-323717	19
FWF-323920	32
FWF-354013	16
FWF-354017	20
FWJ-354220	34
FWF-404517A	23
FWF-404527	36
FWF-404825	56
FWF-455017	26
FWF-455027	41
FWF-455325	62
FWF-505520	37
FWF-505527	50
FWF-505825	77
FWF-556120	53
FWF-556130	81
FWF-556325	85
FWF-606620	57
FWF-606630	87
FWF-606825	91
FWF-657330	120
FWF-707830	125
FWF-758330	135
FWF-808830	145
FWF-859330	150
FWF-909830	160
FWF-9510330	175
FWF-10010830	185

Cage & Needle Roller Assemblies for Large Ends of Connecting Rods
Inscribed Circle Diameter 12 – 30 mm

Cage & Needle Roller Assemblies for Small Ends of Connecting Rods
Inscribed Circle Diameter 9 – 19 mm

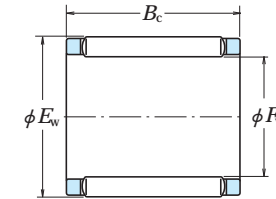
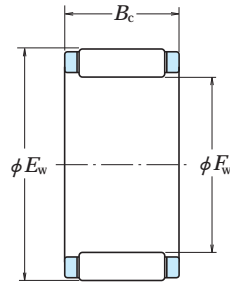

Boundary Dimensions (mm)			Basic Load Ratings (N) (kgf)				Bearing Numbers	Mass (g) approx.
F_w	E_w	$B_c^{-0.2-0.4}$	C_r	C_{0r}	C_r	C_{0r}		
12	16	10	6 100	6 500	620	665	FWF-121610-E	4.0
14	19	10	7 800	8 050	795	820	FWF-141910-E	6.2
	20	12	8 900	8 600	910	880	FWF-142012-E	8.3
15	19	9	5 650	6 250	575	640	FWF-15199-E	4.1
	20	10	7 300	7 600	745	775	FWF-152010-E	6.0
	21	10	7 950	7 500	810	765	FWF-152110-E	8.5
16	21	11	8 650	9 600	880	980	FWF-162111-E	7.5
	22	12	9 500	9 600	965	980	FWF-162212-E	9.5
18	23	14	11 800	14 800	1 200	1 510	FWF-182314-E	10
	24	12	10 000	10 600	1 020	1 080	FWF-182412-E	11
20	26	12	12 200	14 100	1 250	1 440	FWF-202612-E	13
	26	17	16 800	21 200	1 710	2 160	FWF-202617-E	17
	28	18	18 100	19 400	1 840	1 970	FWF-202818-E	25
22	28	14	13 900	17 100	1 420	1 740	FWF-222814-E	14
	29	15	16 300	19 000	1 660	1 930	FWF-222915-E	19
	32	16	19 700	19 400	2 010	1 970	FWF-223216-E	31
23	31	16	17 600	19 400	1 800	1 980	FWF-233116-E	23
24	30	15	15 600	20 300	1 590	2 070	FWF-243015-E	17
	30	17	17 900	24 300	1 830	2 480	FWF-243017-E	19
	31	20	21 600	27 800	2 200	2 840	FWF-243120-E	30
25	32	16	17 700	21 900	1 810	2 230	FWF-253216-E	24
28	35	16	18 400	23 700	1 880	2 410	FWF-283516-E	25
29.75	36.75	16.5	19 600	26 000	1 990	2 650	FWF-293616Z-E	28
30	37	16	21 900	30 500	2 230	3 100	FWF-303716-E	29
	38	18	25 500	34 000	2 600	3 450	FWF-303818-E	35

Boundary Dimensions (mm)			Basic Load Ratings (N) (kgf)				Bearing Numbers	Mass (g) approx.
F_w	E_w	$B_c^{-0.2-0.4}$	C_r	C_{0r}	C_r	C_{0r}		
9	12	11.5	4 300	4 650	440	475	FBN-91211Z-E	3.5
10	14	12.7	5 900	5 950	605	610	FBN-101412Z-E	5.0
12	15	14.3	6 400	8 400	655	855	FBN-121514Z-E	4.8
	16	13	7 250	8 200	740	835	FBN-121613-E	6.4
	16	15.5	8 500	10 000	865	1 020	FBN-121615Z-E	7.0
	16	16	8 500	10 000	865	1 020	FBN-121616-E	7.5
14	18	12	6 950	8 050	710	820	FBN-141812-E	6.5
	18	16.5	9 250	11 600	945	1 180	FBN-141816Z-E	8.5
	18	18	10 700	14 000	1 090	1 430	FBN-141818-E	11.5
	18	20	9 550	12 000	975	1 230	FBN-141820-E1	13
15	19	18	11 300	15 300	1 150	1 560	FBN-151918-E	11
	21	18	12 900	13 900	1 310	1 420	FBN-152118-E	13
16	20	22	13 700	20 000	1 400	2 040	FBN-162022-E	14
	20	23.5	14 900	22 300	1 520	2 280	FBN-162023Z-E	15
	21	20	14 200	18 100	1 450	1 840	FBN-162120-E	16
17	21	23	14 800	22 500	1 510	2 290	FBN-172123-E	16
18	22	17	11 500	16 500	1 170	1 680	FBN-182217-E	12
	22	22	14 200	21 600	1 440	2 200	FBN-182222-E	15
	22	23.6	15 400	24 100	1 570	2 460	FBN-182223Z-E	16
19	23	23.7	16 000	25 800	1 630	2 630	FBN-192323Z-E	17

FJ • MFJ (With Cage)
 F • MF (Full Complement Type)
 Inscribed Circle Diameter 4 – 16 mm

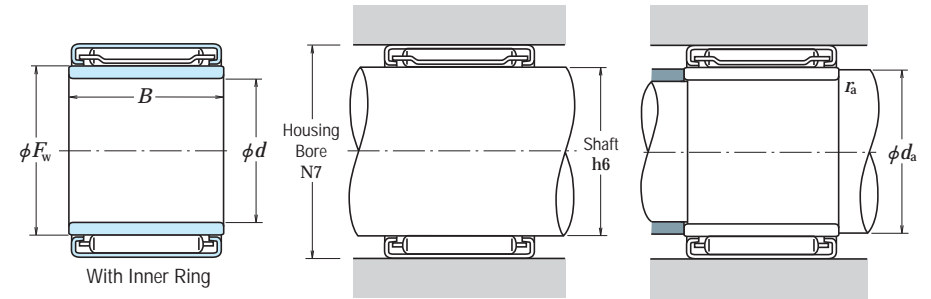
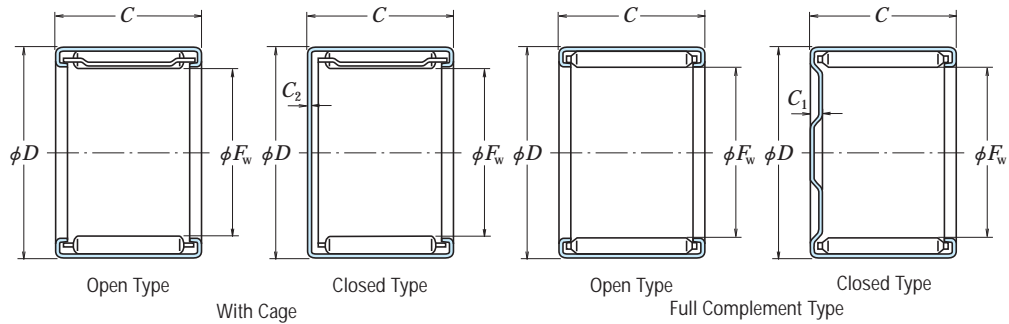

Boundary Dimensions (mm)	Basic Dynamic Load Ratings (N) (kgf)		Limiting Loads (N) (kgf)		Limiting Speeds (min ⁻¹)		Bearing					
	F_w	C_0	C_1	C_2	P_{max}	Grease	Oil	With Cage				
								Open	Closed			
4	8	8	0.8		1 720	175	675	69	45 000	75 000	* FJP-48	—
5	9	9	0.8		1 860	190	745	76	43 000	71 000	FJ-59	MFJ-59
6	10	9	0.8		2 320	237	985	101	36 000	56 000	FJ-69	MFJ-69
7	11	9	0.8		2 550	260	1 110	113	30 000	48 000	FJ-79	MFJ-79
8	12	10	0.8		2 840	289	1 270	130	26 000	43 000	FJ-810	MFJ-810
	14	10	1.0		4 300	435	1 770	180	28 000	45 000	FJH-810	MFJH-810
	14	10	1.9		5 550	565	2 980	305	6 300	10 000	—	—
9	13	10	0.8		3 300	335	1 600	163	22 000	36 000	FJ-910	MFJ-910
	15	10	1.0		4 550	465	1 910	194	24 000	40 000	FJH-910	MFJH-910
	15	10	1.8		6 100	625	3 350	340	6 000	10 000	—	—
10	14	10	0.8		3 500	360	1 760	179	20 000	32 000	FJ-1010	MFJ-1010
	16	10	1.0		4 900	500	2 100	214	22 000	34 000	FJH-1010	MFJH-1010
	16	10	1.9		6 650	680	3 700	375	5 600	9 000	—	—
12	16	10	0.8		4 150	420	2 210	225	17 000	26 000	FJ-1210	MFJ-1210
	18	12	1.0		6 450	655	3 050	310	17 000	28 000	FJH-1212	MFJH-1212
	18	12	1.9		9 000	920	5 700	580	4 500	7 500	—	—
13	19	12	1.0		6 950	710	3 400	345	16 000	26 000	FJ-1312	MFJ-1312
	19	12	1.9		9 550	975	6 100	625	4 300	7 100	—	—
14	20	12	1.0		6 500	665	3 250	335	15 000	24 000	FJ-1412	MFJ-1412
	20	12	2.2		9 450	965	6 350	645	3 800	6 000	—	—
	20	16	1.0		9 500	970	5 300	540	15 000	24 000	FJ-1416	MFJ-1416
	20	16	2.2		13 300	1 360	9 850	1 000	3 800	6 000	—	—
15	21	12	1.0		7 650	780	3 900	400	14 000	22 000	FJ-1512	MFJ-1512
	21	12	1.8		10 300	1 050	6 900	705	3 800	6 000	—	—
	21	14	1.8		12 400	1 270	8 800	895	3 800	6 000	—	—
	21	16	1.0		11 000	1 120	6 200	635	14 000	22 000	FJ-1516	MFJ-1516
	21	16	1.8		14 500	1 480	10 700	1 090	3 800	6 000	—	—
16	22	12	1.0		7 100	725	3 750	380	12 000	20 000	FJ-1612	MFJ-1612
	22	12	2.2		10 200	1 040	7 100	725	3 400	5 300	—	—
	22	16	1.0		10 400	1 060	6 050	620	12 000	20 000	FJ-1616	MFJ-1616
	22	16	2.2		14 400	1 460	11 100	1 130	3 400	5 300	—	—

Note (*) These bearing have polyamide cages. The maximum permissible operating temperature for these bearings is 100 °C for continued operation and 120 °C for short periods.

Numbers	In case of inner ring is used				Mass Without Inner Ring (g)			
	Full Complement Type	Bearing Numbers of Inner Ring	Boundary Dimensions (mm)	Abutment and Fillet Dimensions (mm)	approx.			
	Open	Closed	d	B	d_a (min.)	r_a (max.)	Open	Closed
—	—	—	—	—	—	—	1.3	—
—	—	—	—	—	—	—	1.7	1.9
—	—	—	—	—	—	—	2.2	2.4
—	—	—	—	—	—	—	2.3	2.7
—	—	—	—	—	—	—	2.7	3.2
—	—	—	—	—	—	—	5.2	5.5
FH-810	MFH-810	—	—	—	—	—	6.0	6.3
—	—	—	—	—	—	—	3.2	3.6
—	—	—	—	—	—	—	5.7	6.1
FH-910	MFH-910	—	—	—	—	—	6.4	6.8
—	—	FIR-71010	7	10.5	9	0.3	3.6	4.1
—	—	FIR-71010	7	10.5	9	0.3	6.1	6.6
FH-1010	MFH-1010	FIR-71010	7	10.5	9	0.3	6.9	7.3
—	—	FIR-81210	8	10.5	10	0.3	4.1	4.5
—	—	FIR-81212	8	12.5	10	0.3	7.7	8.2
FH-1212	MFH-1212	FIR-81212	8	12.5	10	0.3	10	11
—	—	FIR-101312	10	12.5	12	0.3	8.6	9.5
F-1312	MF-1312	FIR-101312	10	12.5	12	0.3	11	12
—	—	FIR-101412	10	12.5	12	0.3	10	11
F-1412	MF-1412	FIR-101412	10	12.5	12	0.3	12	14
—	—	FIR-101416	10	16.5	12	0.3	13	14
F-1416	MF-1416	FIR-101416	10	16.5	12	0.3	18	19
—	—	FIR-121512	12	12.5	14	0.3	10	11
F-1512	MF-1512	FIR-121512	12	12.5	14	0.3	12	14
F-1514	MF-1514	—	—	—	—	—	15	16
—	—	FIR-121516	12	16.5	14	0.3	13	14
F-1516	MF-1516	FIR-121516	12	16.5	14	0.3	17	18
—	—	FIR-121612	12	12.5	14	0.3	11	12
F-1612	MF-1612	FIR-121612	12	12.5	14	0.3	14	15
—	—	FIR-121616	12	16.5	14	0.3	14	15
F-1616	MF-1616	FIR-121616	12	16.5	14	0.3	18	20

FJ • MFJ (With Cage)

F • MF (Full Complement Type)

Inscribed Circle Diameter 17 – 28 mm

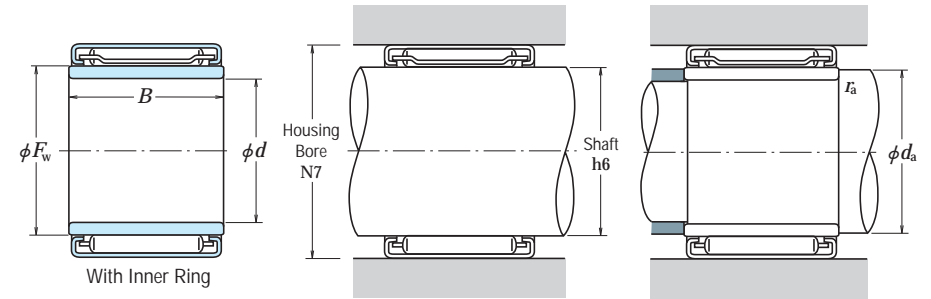
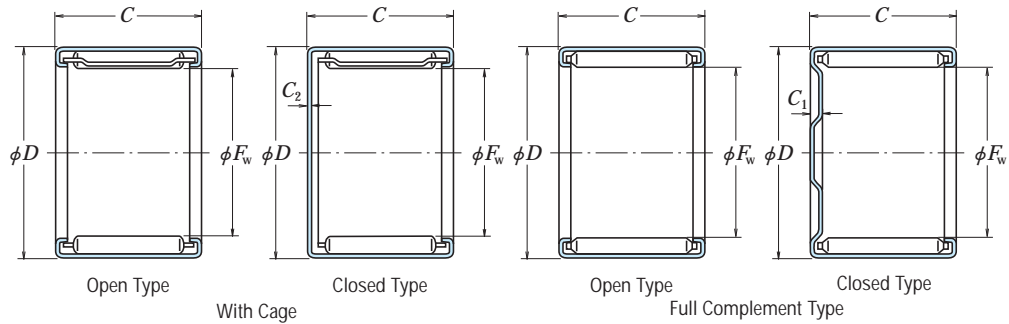

Boundary Dimensions (mm)	Basic Dynamic Load Ratings (N) (kgf)		Limiting Loads (N) (kgf)		Limiting Speeds (min ⁻¹)		Bearing				
	F _w	C _r	P _{max}	Grease	Oil	With Cage					
						Open	Closed				
17	23	12	1.0	8 450	860	4 450	455	12 000	19 000	FJ-1712	MFJ-1712
	23	12	1.8	11 300	1 150	7 750	790	3 400	5 600	—	—
	23	16	1.0	12 100	1 230	7 100	720	12 000	19 000	FJ-1716	MFJ-1716
	23	16	1.8	15 800	1 610	12 000	1 220	3 400	5 600	—	—
18	24	12	1.0	7 650	780	4 200	430	11 000	18 000	FJ-1812	MFJ-1812
	24	12	2.2	10 900	1 110	7 900	805	3 000	5 000	—	—
	24	16	1.0	11 200	1 140	6 800	695	11 000	18 000	FJ-1816	MFJ-1816
	24	16	2.2	15 300	1 560	12 300	1 250	3 000	5 000	—	—
20	26	12	1.0	8 150	835	4 650	475	10 000	16 000	FJ-2012	MFJ-2012
	26	12	2.2	11 500	1 170	8 700	885	2 800	4 500	—	—
	26	16	1.0	11 900	1 210	7 550	770	10 000	16 000	FJ-2016	MFJ-2016
	26	16	2.2	16 200	1 650	13 500	1 380	2 800	4 500	—	—
	26	20	1.0	15 300	1 560	10 500	1 070	10 000	16 000	FJ-2020	MFJ-2020
	26	20	2.2	20 500	2 090	18 300	1 870	2 800	4 500	—	—
22	28	12	1.0	8 650	880	5 150	525	9 000	14 000	FJ-2212	MFJ-2212
	28	12	2.2	12 100	1 230	9 500	970	2 400	4 000	—	—
	28	16	1.0	12 600	1 290	8 350	850	9 000	14 000	FJ-2216	MFJ-2216
	28	16	2.2	17 100	1 740	14 800	1 510	2 400	4 000	—	—
	28	20	1.0	16 200	1 660	11 500	1 180	9 000	14 000	FJ-2220	MFJ-2220
	28	20	2.2	21 600	2 200	20 000	2 040	2 400	4 000	—	—
25	32	16	1.0	15 200	1 550	9 350	955	8 000	13 000	FJ-2516	MFJ-2516
	32	16	2.5	20 200	2 060	16 200	1 650	2 800	4 500	—	—
	32	20	1.0	19 800	2 020	13 100	1 340	8 000	13 000	FJ-2520	MFJ-2520
	32	20	2.5	25 900	2 640	22 200	2 260	2 800	4 500	—	—
	32	26	1.0	26 200	2 670	18 800	1 920	8 000	13 000	FJ-2526	MFJ-2526
	32	26	2.5	34 000	3 450	31 500	3 200	2 800	4 500	—	—
28	35	16	1.0	15 600	1 590	9 950	1 020	7 100	11 000	FJ-2816	MFJ-2816
	35	16	2.5	21 300	2 170	17 900	1 820	2 400	4 000	—	—
	35	20	1.0	20 500	2 090	14 200	1 450	7 100	11 000	FJ-2820	MFJ-2820
	35	20	2.5	27 300	2 780	24 600	2 510	2 400	4 000	—	—
	35	26	1.0	26 900	2 750	20 200	2 060	7 100	11 000	FJ-2826	MFJ-2826
	35	26	2.5	35 500	3 650	34 500	3 550	2 400	4 000	—	—

Numbers	In case of inner ring is used						Mass Without Inner Ring (g)		
	Full Complement Type		Bearing Numbers of Inner Ring	Boundary Dimensions (mm)		Abutment and Fillet Dimensions (mm)		approx.	
	Open	Closed		d	B	d _a (min.)	r _a (max.)	Open	Closed
—	—	—	—	—	—	—	—	10	11
F-1712	MF-1712	—	—	—	—	—	—	14	15
—	—	—	—	—	—	—	—	14	16
F-1716	MF-1716	—	—	—	—	—	—	18	20
—	—	FIR-151812	15	12.5	17	0.3	—	12	14
F-1812	MF-1812	FIR-151812	15	12.5	17	0.3	—	14	16
—	—	FIR-151816	15	16.5	17	0.3	—	16	18
F-1816	MF-1816	FIR-151816	15	16.5	17	0.3	—	19	22
—	—	FIR-172012	17	12.5	19	0.3	—	13	15
F-2012	MF-2012	FIR-172012	17	12.5	19	0.3	—	17	19
—	—	FIR-172016	17	16.5	19	0.3	—	17	19
F-2016	MF-2016	FIR-172016	17	16.5	19	0.3	—	22	25
—	—	FIR-172020	17	20.5	19	0.3	—	22	24
F-2020	MF-2020	FIR-172020	17	20.5	19	0.3	—	28	30
—	—	FIR-172212	17	12.5	19	0.3	—	14	17
F-2212	MF-2212	FIR-172212	17	12.5	19	0.3	—	18	21
—	—	FIR-172216	17	16.5	19	0.3	—	19	22
F-2216	MF-2216	FIR-172216	17	16.5	19	0.3	—	24	27
—	—	FIR-172220	17	20.5	19	0.3	—	23	26
F-2220	MF-2220	FIR-172220	17	20.5	19	0.3	—	30	33
—	—	FIR-202516	20	16.5	22	0.3	—	24	27
F-2516	MF-2516	FIR-202516	20	16.5	22	0.3	—	31	35
—	—	FIR-202520	20	20.5	22	0.3	—	31	34
F-2520	MF-2520	FIR-202520	20	20.5	22	0.3	—	40	43
—	—	FIR-202526	20	26.5	22	0.3	—	40	43
F-2526	MF-2526	FIR-202526	20	26.5	22	0.3	—	52	55
—	—	FIR-222816	22	16.5	24	0.3	—	27	31
F-2816	MF-2816	FIR-222816	22	16.5	24	0.3	—	35	40
—	—	FIR-222820	22	20.5	24	0.3	—	34	38
F-2820	MF-2820	FIR-222820	22	20.5	24	0.3	—	44	48
—	—	FIR-222826	22	26.5	24	0.3	—	45	49
F-2826	MF-2826	FIR-222826	22	26.5	24	0.3	—	57	62

FJ • MFJ (With Cage)

F • MF (Full Complement Type)

Inscribed Circle Diameter 30 – 55 mm

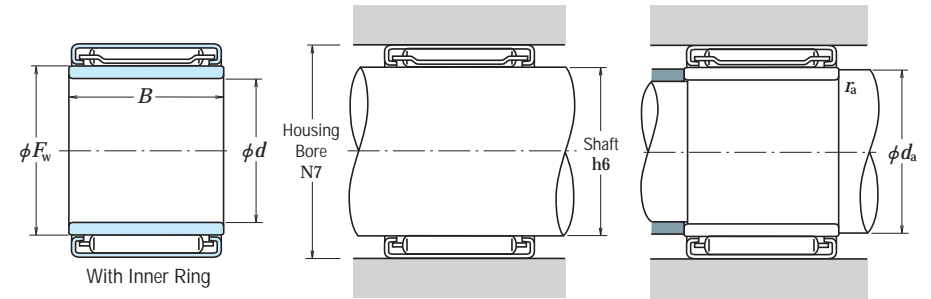
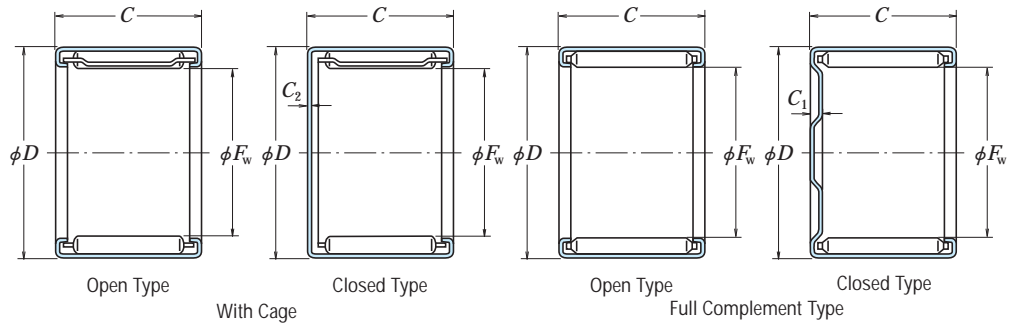

Boundary Dimensions (mm)	Basic Dynamic Load Ratings (N) (kgf)		Limiting Loads (N) (kgf)		Limiting Speeds (min ⁻¹)		Bearing		
	F_w	D	$C^{-0.25}$	C_1, C_2 max.	C_r	P_{max}	With Cage		
							Grease	Oil	
30	37	16	1.0	15 600	1 590	10 100	1 030	FJ-3016L	MFJ-3016
	37	16	2.5	22 100	2 250	18 900	1 930	—	—
	37	20	1.0	19 400	1 970	13 300	1 360	FJ-3020	MFJ-3020
35	37	20	2.5	28 400	2 900	26 200	2 670	—	—
	37	26	1.0	26 000	2 660	19 500	1 990	FJ-3026	MFJ-3026
	37	26	2.5	37 000	3 800	37 000	3 750	—	—
40	42	16	1.0	18 100	1 850	12 800	1 300	FJ-3516	MFJ-3516
	42	16	2.5	24 000	2 450	22 000	2 240	—	—
	42	20	1.0	23 600	2 410	17 900	1 830	FJ-3520	MFJ-3520
45	42	20	2.5	31 000	3 150	30 000	3 100	—	—
	42	26	1.0	31 500	3 200	25 800	2 630	FJ-3526	MFJ-3526
	42	26	2.5	40 000	4 100	42 500	4 350	—	—
50	47	16	1.0	18 600	1 890	13 600	1 390	FJ-4016	MFJ-4016
	47	16	2.5	25 700	2 620	24 900	2 540	—	—
	47	20	1.0	23 500	2 400	18 500	1 890	FJ-4020	MFJ-4020
55	47	20	2.5	32 500	3 350	34 000	3 450	—	—
	47	26	1.0	31 500	3 200	26 900	2 740	FJ-4026	MFJ-4026
	52	16	1.0	19 900	2 030	15 400	1 570	FJ-4516	MFJ-4516
60	52	16	2.5	27 300	2 790	27 800	2 840	—	—
	52	20	1.0	25 500	2 600	21 200	2 160	FJ-4520	MFJ-4520
	52	20	2.5	35 000	3 550	38 500	3 900	—	—
65	58	20	1.1	28 900	2 940	23 100	2 350	FJ-5020L	MFJ-5020
	58	20	2.8	39 500	4 050	41 500	4 250	—	—
	58	24	1.1	36 000	3 700	30 500	3 150	FJ-5024	MFJ-5024
70	58	24	2.8	48 000	4 900	53 000	5 400	—	—
	63	20	1.1	30 000	3 100	25 100	2 560	FJ-5520	MFJ-5520
	63	20	2.8	41 500	4 250	45 500	4 650	—	—
75	63	24	1.1	37 500	3 850	33 500	3 400	FJ-5524	MFJ-5524
	63	24	2.8	50 500	5 150	58 000	5 950	—	—
	63	24	2.8	50 500	5 150	58 000	5 950	—	—

Numbers	In case of inner ring is used				Mass Without Inner Ring (g)			
	Full Complement Type		Bearing Numbers of Inner Ring	Boundary Dimensions (mm)		approx.		
	Open	Closed		d	B	Open	Closed	
—	—	—	—	—	—	26	31	
F-3016	MF-3016	—	—	—	—	35	40	
—	—	FIR-253020	25	20.5	27	0.3	35	39
F-3020	MF-3020	—	—	—	—	46	51	
—	—	FIR-253026	25	26.5	27	0.3	46	50
F-3026	MF-3026	—	—	—	—	61	66	
—	—	FIR-253026	25	26.5	27	0.3	61	66
—	—	—	—	—	—	32	38	
F-3516	MF-3516	—	—	—	—	53	60	
—	—	FIR-303520	30	20.5	34	0.6	41	45
—	—	—	—	—	—	42	49	
F-3520	MF-3520	—	—	—	—	54	58	
—	—	FIR-303526	30	26.5	34	0.6	70	76
F-3526	MF-3526	—	—	—	—	70	76	
—	—	FIR-303526	30	26.5	34	0.6	70	76
—	—	—	—	—	—	34	43	
F-4016	MF-4016	—	—	—	—	48	56	
—	—	FIR-354020	35	20.5	39	0.6	46	51
—	—	—	—	—	—	60	69	
F-4020	MF-4020	—	—	—	—	60	65	
—	—	FIR-354026	35	26.5	39	0.6	60	65
—	—	—	—	—	—	39	50	
F-4516	MF-4516	—	—	—	—	53	64	
—	—	—	—	—	—	53	59	
F-4520	MF-4520	—	—	—	—	67	78	
—	—	FIR-404520	40	20.5	44	0.6	67	78
—	—	FIR-404520	40	20.5	44	0.6	67	78
—	—	—	—	—	—	56	71	
F-5020	MF-5020	—	—	—	—	81	95	
—	—	—	—	—	—	69	84	
F-5024	MF-5024	—	—	—	—	98	110	
—	—	FIR-455020	45	20.5	49	0.6	60	79
—	—	—	—	—	—	88	105	
F-5520	MF-5520	—	—	—	—	72	90	
—	—	—	—	—	—	105	125	
F-5524	MF-5524	—	—	—	—	105	125	

RLM • LM

RNA • NA

Inscribed Circle Diameter 9 – 22 mm

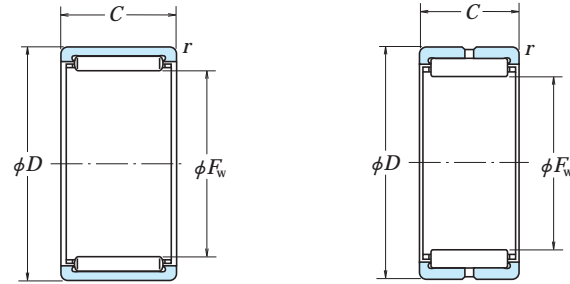

Without Inner Ring

RLM

RNA

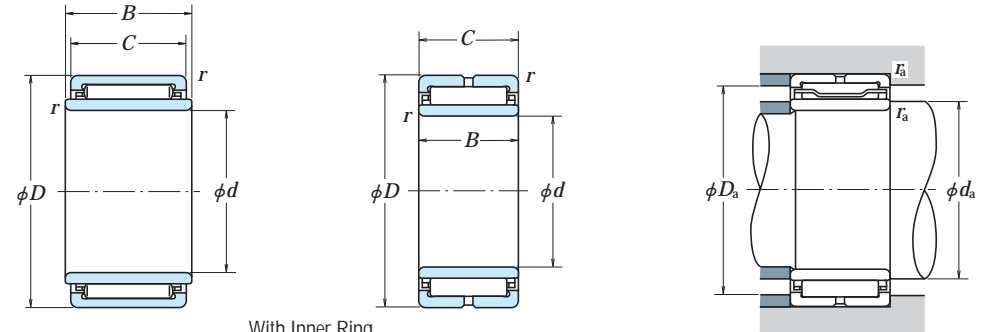

With Inner Ring

LM

NA

F_W	Boundary Dimensions (mm)			Basic Load Ratings (N)				Limiting Speeds (min^{-1})		Bearing
	D	C	r min.	C_r	C_{0r}	(kgf)		Grease	Oil	
9	16	12	0.3	6 150	5 400	625	550	24 000	40 000	RLM 912 RLM 916
	16	16	0.3	7 900	7 450	805	760	24 000	40 000	
10	17	10	0.3	5 350	4 650	545	470	22 000	36 000	RLM 101710 RLM 101715
	17	15	0.3	8 050	7 800	820	795	22 000	36 000	
12	17	12	0.3	6 150	7 650	625	780	18 000	30 000	RLM 1212 RLM 121912
	19	12	0.3	7 300	7 150	745	730	18 000	30 000	
14	22	13	0.3	9 150	9 950	930	1 010	20 000	32 000	— RLM 1416 RLM 1420
	22	16	0.3	12 100	12 700	1 230	1 300	15 000	24 000	
	22	20	0.3	15 500	17 500	1 580	1 790	15 000	24 000	
15	20	15	0.3	8 100	11 700	825	1 190	14 000	24 000	RLM 1515 RLM 1520 RLM 152215
	20	20	0.3	11 100	17 400	1 130	1 770	14 000	24 000	
	22	15	0.3	9 900	11 100	1 010	1 140	14 000	24 000	
16	24	13	0.3	10 100	11 700	1 030	1 190	17 000	28 000	— RLM 1616 RLM 1620 —
	24	16	0.3	12 900	14 200	1 310	1 450	13 000	22 000	
	24	20	0.3	16 500	19 500	1 680	1 990	13 000	22 000	
	24	22	0.3	17 900	24 500	1 830	2 500	17 000	28 000	
17	22	10	0.3	5 850	7 950	595	810	13 000	20 000	RLM 1710 RLM 172425
	24	25	0.5	18 200	25 300	1 850	2 580	13 000	20 000	
18	25	15	0.5	11 500	14 300	1 170	1 450	12 000	20 000	RLM 1815 RLM 1820
	25	20	0.5	15 800	21 500	1 610	2 190	12 000	20 000	
20	27	10	0.5	7 950	9 150	810	930	11 000	18 000	RLM 2010 RLM 2015 RLM 2020 RLM 2025
	27	15	0.5	11 900	15 400	1 220	1 570	11 000	18 000	
	27	20	0.5	16 400	23 200	1 670	2 370	11 000	18 000	
	27	25	0.5	19 800	29 500	2 010	3 000	11 000	18 000	
22	28	13	0.3	10 800	13 600	1 100	1 390	13 000	22 000	— — —
	28	18	0.3	15 700	21 900	1 600	2 240	13 000	22 000	
	28	23	0.3	19 300	28 600	1 960	2 920	13 000	22 000	
22	29	20	0.5	17 700	26 400	1 810	2 690	10 000	16 000	RLM 2220 RLM 2225
	29	25	0.5	21 300	33 500	2 170	3 400	10 000	16 000	
30	30	13	0.3	11 600	15 400	1 190	1 570	12 000	20 000	— — — RLM 223020 —
	30	18	0.3	16 800	24 800	1 720	2 530	12 000	20 000	
	30	20	0.5	20 000	27 200	2 030	2 780	10 000	16 000	
	30	23	0.3	20 700	32 500	2 110	3 300	12 000	20 000	
	30	23	0.3	20 700	32 500	2 110	3 300	12 000	20 000	

Remarks If a full complement roller bearing is required, please contact NSK.

Numbers		Boundary Dimensions (mm)		Abutment and Fillet Dimensions (mm)			Mass (kg)	
Without Inner Ring	With Inner Ring	d	B	d_a min.	D_a max.	r_a max.	approx.	
							Without Inner Ring	With Inner Ring
—	LM 91612-1	6	12	8	14	0.3	0.009	0.013
—	—	—	—	—	14	0.3	0.011	—
—	—	—	—	—	15	0.3	0.008	—
—	—	—	—	—	15	0.3	0.012	—
—	LM 1212	8	12.2	10	15	0.3	0.007	0.013
—	LM 121912	8	12.2	10	17	0.3	0.011	0.017
RNA 4900	NA 4900	10	13	12	20	0.3	0.016	0.024
—	LM 1416	10	16.2	12	20	0.3	0.019	0.028
—	LM 1420	10	20.2	12	20	0.3	0.024	0.036
—	LM 1515	10	15.2	12	18	0.3	0.011	0.022
—	LM 1520	10	20.2	12	18	0.3	0.015	0.03
—	LM 152215	10	15.2	12	20	0.3	0.016	0.027
RNA 4901	NA 4901	12	13	14	22	0.3	0.018	0.027
—	LM 1616	12	16.2	14	22	0.3	0.021	0.032
—	LM 1620	12	20.2	14	22	0.3	0.027	0.041
RNA 6901	NA 6901	12	22	14	22	0.3	0.03	0.045
—	LM 1710	12	10.2	14	20	0.3	0.008	0.017
—	LM 172425	12	25.2	16	20	0.5	0.03	0.052
—	LM 1815	15	15.2	19	21	0.5	0.019	0.028
—	LM 1820	15	20.2	19	21	0.5	0.025	0.037
—	LM 2010	15	10.2	19	23	0.5	0.014	0.025
—	LM 2015	15	15.2	19	23	0.5	0.021	0.037
—	LM 2020	15	20.2	19	23	0.5	0.028	0.049
—	LM 2025	15	25.2	19	23	0.5	0.035	0.061
RNA 4902	NA 4902	15	13	17	26	0.3	0.021	0.035
RNA 5902	NA 5902	15	18	17	26	0.3	0.032	0.051
RNA 6902	NA 6902	15	23	17	26	0.3	0.039	0.064
—	LM 2220	17	20.2	21	25	0.5	0.03	0.054
—	LM 2225	17	25.2	21	25	0.5	0.038	0.068
RNA 4903	NA 4903	17	13	19	28	0.3	0.023	0.038
RNA 5903	NA 5903	17	18	19	28	0.3	0.034	0.055
—	LM 223020	17	20.2	21	26	0.5	0.035	0.06
RNA 6903	NA 6903	17	23	19	28	0.3	0.041	0.068

RLM • LM

RNA • NA

Inscribed Circle Diameter 25 – 35 mm

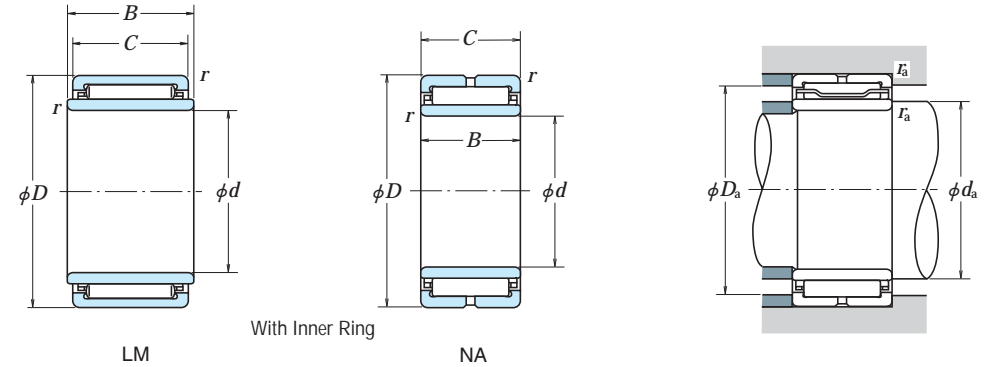
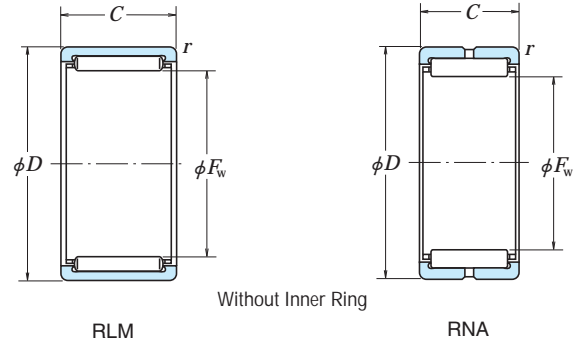

F_w	Boundary Dimensions (mm)			Basic Load Ratings (N)				Limiting Speeds (min^{-1})		Bearing
	D	C	r min.	C_r	C_{0r}	C_r	C_{0r}	Grease	Oil	
25	32	12	0.5	10 300	13 700	1 050	1 400	8 500	14 000	RLM 2512
	32	20	0.5	18 800	29 700	1 920	3 050	8 500	14 000	RLM 2520
	32	25	0.5	22 700	37 500	2 310	3 850	8 500	14 000	RLM 2525
28	37	17	0.3	19 700	22 900	2 010	2 340	11 000	18 000	—
	37	23	0.3	27 800	35 500	2 830	3 650	11 000	18 000	—
	37	30	0.3	36 500	50 500	3 700	5 150	11 000	18 000	—
30	35	20	0.5	19 900	33 000	2 030	3 350	7 500	12 000	RLM 2820
	35	25	0.5	23 900	42 000	2 440	4 250	7 500	12 000	RLM 2825
	37	30	0.5	34 000	52 500	3 450	5 350	7 500	12 000	RLM 283730
32	39	17	0.3	22 400	30 500	2 290	3 150	9 500	15 000	—
	39	23	0.3	28 300	41 500	2 890	4 200	9 500	15 000	—
	39	30	0.3	37 000	58 500	3 800	6 000	9 500	15 000	—
35	40	20	0.5	24 500	44 000	2 490	4 500	7 100	12 000	RLM 3025
	40	25	0.5	25 000	36 000	2 550	3 650	7 100	12 000	RLM 304020
	40	30	0.5	35 000	56 000	3 600	5 700	7 100	12 000	RLM 304030
32	42	17	0.3	21 400	26 800	2 180	2 740	9 000	14 000	—
	42	23	0.3	30 000	41 500	3 100	4 250	9 000	14 000	—
	42	30	0.3	39 500	59 000	4 050	6 050	9 000	14 000	—
33	42	20	0.5	25 800	38 000	2 630	3 900	6 700	11 000	RLM 3220
	42	30	0.5	36 500	59 000	3 700	6 050	6 700	11 000	RLM 3230
	45	17	0.3	22 200	28 700	2 270	2 930	8 500	13 000	—
34	45	23	0.3	31 500	44 500	3 200	4 550	8 500	13 000	—
	45	30	0.3	41 000	63 500	4 200	6 450	8 500	13 000	—
	35	42	20	0.5	22 300	41 000	2 270	4 200	6 300	10 000
42		30	0.5	31 000	63 500	3 200	6 450	6 300	10 000	RLM 3530
45		20	0.5	27 500	42 500	2 800	4 350	6 300	10 000	RLM 354520
36	45	25	0.5	33 000	54 500	3 400	5 550	6 300	10 000	RLM 354525
	45	30	0.5	38 500	66 000	3 950	6 750	6 300	10 000	RLM 354530
	47	17	0.3	23 900	32 500	2 430	3 300	7 500	12 000	—
37	47	23	0.3	33 500	50 500	3 450	5 150	7 500	12 000	—
	47	30	0.3	44 000	71 500	4 500	7 300	7 500	12 000	—

Numbers		Boundary Dimensions (mm)		Abutment and Fillet Dimensions (mm)			Mass (kg)	
Without Inner Ring	With Inner Ring	d	B	d_a min.	D_a max.	r_a max.	approx.	
							Without Inner Ring	With Inner Ring
—	LM 2512	20	12.2	24	28	0.5	0.02	0.036
—	LM 2520	20	20.2	24	28	0.5	0.034	0.061
—	LM 2525	20	25.2	24	28	0.5	0.042	0.076
RNA 4904	NA 4904	20	17	22	35	0.3	0.055	0.077
RNA 5904	NA 5904	20	23	22	35	0.3	0.089	0.12
RNA 6904	NA 6904	20	30	22	35	0.3	0.098	0.14
—	LM 2820	22	20.2	26	31	0.5	0.038	0.062
—	LM 2825	22	25.2	26	31	0.5	0.047	0.092
—	LM 283730	22	30.2	26	33	0.5	0.075	0.13
RNA 49/22	NA 49/22	22	17	24	37	0.3	0.056	0.086
RNA 59/22	NA 59/22	22	23	24	37	0.3	0.091	0.135
RNA 69/22	NA 69/22	22	30	24	37	0.3	0.096	0.15
—	LM 3025	25	25.2	29	33	0.5	0.05	0.092
—	LM 304020	25	20.2	29	36	0.5	0.06	0.093
—	LM 304030	25	30.2	29	36	0.5	0.09	0.14
RNA 4905	NA 4905	25	17	27	40	0.3	0.063	0.091
RNA 5905	NA 5905	25	23	27	40	0.3	0.10	0.14
RNA 6905	NA 6905	25	30	27	40	0.3	0.11	0.16
—	LM 3220	28	20.2	32	38	0.5	0.064	0.09
—	LM 3230	28	30.2	32	38	0.5	0.096	0.14
RNA 49/28	NA 49/28	28	17	30	43	0.3	0.076	0.099
RNA 59/28	NA 59/28	28	23	30	43	0.3	0.11	0.145
RNA 69/28	NA 69/28	28	30	30	43	0.3	0.13	0.175
—	LM 3520	30	20.2	34	38	0.5	0.046	0.085
—	LM 3530	30	30.2	34	38	0.5	0.07	0.13
—	LM 354520	30	20.2	34	41	0.5	0.069	0.11
—	LM 354525	30	25.2	34	41	0.5	0.086	0.135
—	LM 354530	30	30.2	34	41	0.5	0.10	0.16
RNA 4906	NA 4906	30	17	32	45	0.3	0.072	0.105
RNA 5906	NA 5906	30	23	32	45	0.3	0.11	0.15
RNA 6906	NA 6906	30	30	32	45	0.3	0.13	0.19

Remarks If a full complement roller bearing is required, please contact NSK.

RLM • LM

RNA • NA

Inscribed Circle Diameter 37 – 58 mm

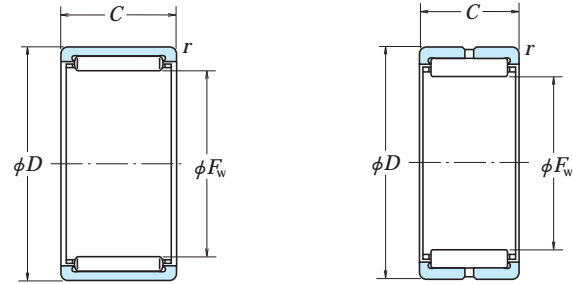

Without Inner Ring

RLM

RNA

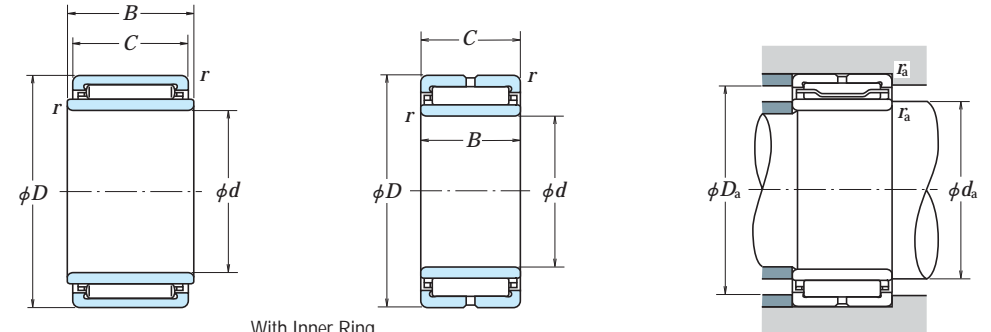

With Inner Ring

LM

NA

F_W	Boundary Dimensions (mm)			Basic Load Ratings (N)				Limiting Speeds (min^{-1})		Bearing
	D	C	r min.	C_r	C_{0r}	C_r	C_{0r}	Grease	Oil	
37	47	20	0.6	28 200	45 000	2 880	4 550	6 000	9 500	RLM 3720 RLM 3730
	47	30	0.6	39 500	69 500	4 050	7 100	6 000	9 500	
38	48	20	0.6	29 000	47 000	2 960	4 800	5 600	9 000	RLM 3820 RLM 3830
	48	30	0.6	41 000	73 000	4 150	7 450	5 600	9 000	
40	50	20	0.6	29 700	49 000	3 050	5 000	5 300	9 000	RLM 4020 RLM 4030
	50	30	0.6	42 000	76 500	4 250	7 800	5 300	9 000	
42	52	20	0.6	29 900	45 000	3 050	4 600	6 700	10 000	—
	52	27	0.6	40 500	66 000	4 100	6 750	6 700	10 000	
	52	36	0.6	56 000	101 000	5 700	10 300	6 700	10 000	
45	55	20	0.6	30 500	47 500	3 100	4 800	6 300	10 000	—
	55	27	0.6	41 500	69 500	4 200	7 100	6 300	10 000	
	55	36	0.6	57 500	106 000	5 850	10 900	6 300	10 000	
48	62	22	0.6	39 000	61 500	3 950	6 300	5 600	9 000	—
	62	30	0.6	54 500	95 000	5 550	9 700	5 600	9 000	
50	62	20	0.6	35 500	60 500	3 600	6 150	4 300	7 100	RLM 506220 RLM 506225
	62	25	0.6	43 000	77 500	4 400	7 900	4 300	7 100	
52	68	22	0.6	41 000	67 500	4 150	6 900	5 000	8 000	—
	68	30	0.6	57 000	104 000	5 800	10 600	5 000	8 000	
	68	40	0.6	76 000	149 000	7 750	15 200	5 000	8 000	
55	65	30	0.6	49 000	104 000	5 000	10 600	4 000	6 300	RLM 5530 RLM 556720
	67	20	0.6	38 000	68 000	3 850	6 900	4 000	6 300	
58	72	22	0.6	42 500	73 500	4 350	7 500	4 500	7 100	—
	72	30	0.6	59 500	113 000	6 050	11 500	4 500	7 100	
	72	40	0.6	79 000	163 000	8 050	16 600	4 500	7 100	

Remarks If a full complement roller bearing is required, please contact NSK.

Numbers		Boundary Dimensions (mm)		Abutment and Fillet Dimensions (mm)			Mass (kg)	
Without Inner Ring	With Inner Ring	d	B	d_a min.	D_a max.	r_a max.	approx.	
							Without Inner Ring	With Inner Ring
—	LM 3720	32	20.3	36	43	0.6	0.072	0.115
—	LM 3730	32	30.3	36	43	0.6	0.11	0.17
—	LM 3820	32	20.3	36	44	0.6	0.074	0.125
—	LM 3830	32	30.3	36	44	0.6	0.11	0.195
—	LM 4020	35	20.3	39	46	0.6	0.078	0.125
—	LM 4030	35	30.3	39	46	0.6	0.12	0.19
RNA 49/32	NA 49/32	32	20	36	48	0.6	0.092	0.16
RNA 59/32	NA 59/32	32	27	36	48	0.6	0.15	0.24
RNA 69/32	NA 69/32	32	36	36	48	0.6	0.17	0.29
RNA 4907	NA 4907	35	20	39	51	0.6	0.11	0.17
RNA 5907	NA 5907	35	27	39	51	0.6	0.175	0.25
RNA 6907	NA 6907	35	36	39	51	0.6	0.20	0.315
—	LM 4520	40	20.3	44	51	0.6	0.086	0.14
—	LM 4530	40	30.3	44	51	0.6	0.13	0.21
RNA 4908	NA 4908	40	22	44	58	0.6	0.15	0.24
RNA 5908	NA 5908	40	30	44	58	0.6	0.23	0.355
RNA 6908	NA 6908	40	40	44	58	0.6	0.265	0.435
—	LM 506220	42	20.3	46	58	0.6	0.12	0.21
—	LM 506225	42	25.3	46	58	0.6	0.155	0.265
RNA 4909	NA 4909	45	22	49	64	0.6	0.19	0.28
RNA 5909	NA 5909	45	30	49	64	0.6	0.27	0.39
RNA 6909	NA 6909	45	40	49	64	0.6	0.335	0.495
—	LM 5530	45	30.3	49	61	0.6	0.16	0.34
—	LM 556720	45	20.3	49	63	0.6	0.13	0.25
RNA 4910	NA 4910	50	22	54	68	0.6	0.18	0.295
RNA 5910	NA 5910	50	30	54	68	0.6	0.25	0.405
RNA 6910	NA 6910	50	40	54	68	0.6	0.32	0.53

RNA • NA

Inscribed Circle Diameter 63 – 120 mm

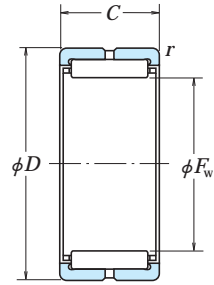

Without Inner Ring
RNA

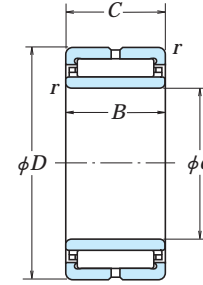

With Inner Ring
NA

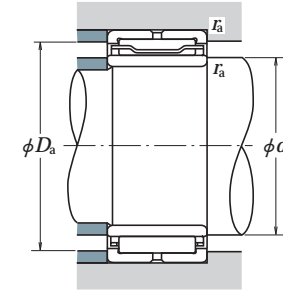

Boundary Dimensions (mm)	Basic Load Ratings				Limiting Speeds		Bearing			
	F_w	D	C	r min.	(N)	(kgf)		(min ⁻¹)		
				C_r	C_{0r}	C_r	C_{0r}	Grease	Oil	Without Inner Ring
63	80	25	1	53 500	87 500	5 450	8 950	4 000	6 700	RNA 4911
	80	34	1	73 500	133 000	7 500	13 600	4 000	6 700	RNA 5911
	80	45	1	93 500	181 000	9 550	18 500	4 000	6 700	RNA 6911
68	85	25	1	56 000	95 500	5 700	9 750	3 800	6 300	RNA 4912
	85	34	1	77 500	145 000	7 900	14 800	3 800	6 300	RNA 5912
	85	45	1	98 000	197 000	10 000	20 100	3 800	6 300	RNA 6912
72	90	25	1	58 500	103 000	5 950	10 500	3 600	5 600	RNA 4913
	90	34	1	81 000	157 000	8 250	16 000	3 600	5 600	RNA 5913
	90	45	1	103 000	213 000	10 500	21 800	3 600	5 600	RNA 6913
80	100	30	1	80 500	143 000	8 200	14 600	3 200	5 300	RNA 4914
	100	40	1	107 000	206 000	10 900	21 000	3 200	5 300	RNA 5914
	100	54	1	143 000	298 000	14 500	30 500	3 200	5 300	RNA 6914
85	105	30	1	84 000	155 000	8 600	15 800	3 000	5 000	RNA 4915
	105	40	1	112 000	222 000	11 400	22 700	3 000	5 000	RNA 5915
	105	54	1	149 000	325 000	15 200	33 000	3 000	5 000	RNA 6915
90	110	30	1	87 500	166 000	8 950	17 000	2 800	4 500	RNA 4916
	110	40	1	116 000	239 000	11 900	24 400	2 800	4 500	RNA 5916
	110	54	1	157 000	350 000	16 000	36 000	2 800	4 500	RNA 6916
100	120	35	1.1	104 000	214 000	10 600	21 800	2 600	4 000	RNA 4917
	120	46	1.1	138 000	310 000	14 100	31 500	2 600	4 000	RNA 5917
	120	63	1.1	174 000	415 000	17 800	42 500	2 600	4 000	RNA 6917
105	125	35	1.1	108 000	228 000	11 000	23 300	2 400	4 000	RNA 4918
	125	46	1.1	143 000	330 000	14 600	33 500	2 400	4 000	RNA 5918
	125	63	1.1	181 000	445 000	18 400	45 000	2 400	4 000	RNA 6918
110	130	35	1.1	111 000	242 000	11 400	24 700	2 200	3 800	RNA 4919
	130	46	1.1	148 000	350 000	15 100	35 500	2 200	3 800	RNA 5919
	130	63	1.1	187 000	470 000	19 100	48 000	2 200	3 800	RNA 6919
115	140	40	1.1	144 000	295 000	14 700	30 000	2 200	3 600	RNA 4920
	140	54	1.1	193 000	430 000	19 700	43 500	2 200	3 600	RNA 5920
	140	30	1	99 500	214 000	10 100	21 900	2 000	3 400	RNA 4822

Remarks If a full complement roller bearing is required, please contact NSK.

Numbers	Boundary Dimensions (mm)		Abutment and Fillet Dimensions (mm)			Mass (kg)	
	d	B	d_a min.	D_a max.	r_a max.	Without Inner Ring	With Inner Ring
NA 4911	55	25	60	75	1	0.26	0.40
	55	34	60	75	1	0.37	0.56
	55	45	60	75	1	0.475	0.73
NA 4912	60	25	65	80	1	0.28	0.435
	60	34	65	80	1	0.415	0.625
	60	45	65	80	1	0.485	0.76
NA 4913	65	25	70	85	1	0.32	0.465
	65	34	70	85	1	0.48	0.675
	65	45	70	85	1	0.53	0.79
NA 4914	70	30	75	95	1	0.47	0.74
	70	40	75	95	1	0.69	1.05
	70	54	75	95	1	0.89	1.4
NA 4915	75	30	80	100	1	0.5	0.79
	75	40	80	100	1	0.735	1.1
	75	54	80	100	1	0.96	1.5
NA 4916	80	30	85	105	1	0.53	0.835
	80	40	85	105	1	0.75	1.15
	80	54	85	105	1	0.99	1.55
NA 4917	85	35	91.5	113.5	1	0.68	1.25
	85	46	91.5	113.5	1	0.99	1.75
	85	63	91.5	113.5	1	1.2	2.25
NA 4918	90	35	96.5	118.5	1	0.72	1.35
	90	46	96.5	118.5	1	1.05	1.85
	90	63	96.5	118.5	1	1.35	2.45
NA 4919	95	35	101.5	123.5	1	0.74	1.4
	95	46	101.5	123.5	1	1.15	2.0
	95	63	101.5	123.5	1	1.5	2.65
NA 4920	100	40	106.5	133.5	1	1.15	1.95
	100	54	106.5	133.5	1	1.8	2.85
	110	30	115	135	1	0.67	1.1

RNA • NA

Inscribed Circle Diameter 125 – 390 mm

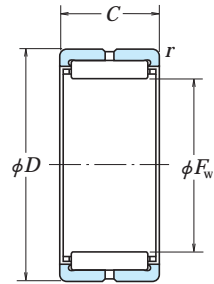

Without Inner Ring
RNA

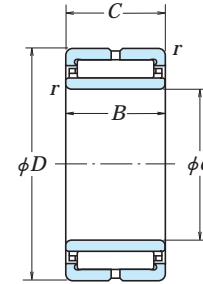

With Inner Ring
NA

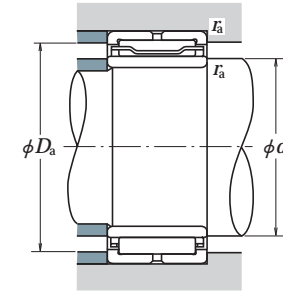

Boundary Dimensions (mm)				Basic Load Ratings (N) (kgf)				Limiting Speeds (min ⁻¹)		Bearing Without Inner Ring
<i>F_W</i>	<i>D</i>	<i>C</i>	<i>r</i> min.	<i>C_r</i>	<i>C_{0r}</i>	<i>C_r</i>	<i>C_{0r}</i>	Grease	Oil	
125	150	40	1.1	149 000	315 000	15 200	32 500	2 000	3 200	RNA 4922 RNA 5922
	150	54	1.1	200 000	460 000	20 300	47 000	2 000	3 200	
130	150	30	1	105 000	238 000	10 700	24 300	1 900	3 200	RNA 4824
135	165	45	1.1	192 000	395 000	19 600	40 500	1 900	3 000	RNA 4924 RNA 5924
	165	60	1.1	253 000	565 000	25 800	58 000	1 900	3 000	
145	165	35	1.1	127 000	315 000	12 900	32 000	1 700	2 800	RNA 4826
150	180	50	1.5	228 000	515 000	23 200	52 500	1 700	2 800	RNA 4926 RNA 5926
	180	67	1.5	299 000	725 000	30 500	74 000	1 700	2 800	
155	175	35	1.1	133 000	340 000	13 600	35 000	1 600	2 600	RNA 4828
160	190	50	1.5	235 000	545 000	24 000	55 500	1 600	2 600	RNA 4928 RNA 5928
	190	67	1.5	310 000	775 000	31 500	79 000	1 600	2 600	
165	190	40	1.1	180 000	440 000	18 300	45 000	1 500	2 400	RNA 4830
175 185 195	200	40	1.1	184 000	465 000	18 700	47 000	1 400	2 200	RNA 4832 RNA 4834 RNA 4836
	215	45	1.1	224 000	540 000	22 900	55 000	1 400	2 200	
	225	45	1.1	230 000	570 000	23 500	58 000	1 300	2 000	
210 220 240	240	50	1.5	268 000	705 000	27 300	72 000	1 200	1 900	RNA 4838 RNA 4840 RNA 4844
	250	50	1.5	274 000	740 000	27 900	75 500	1 100	1 800	
	270	50	1.5	286 000	805 000	29 100	82 000	1 000	1 700	
265 285 305	300	60	2	375 000	1 070 000	38 500	109 000	950	1 500	RNA 4848 RNA 4852 RNA 4856
	320	60	2	395 000	1 160 000	40 000	118 000	900	1 400	
	350	69	2	510 000	1 390 000	52 000	142 000	800	1 300	
330 350 370 390	380	80	2.1	660 000	1 810 000	67 500	185 000	750	1 200	RNA 4860 RNA 4864 RNA 4868 RNA 4872
	400	80	2.1	675 000	1 900 000	69 000	194 000	710	1 100	
	420	80	2.1	690 000	1 990 000	70 500	203 000	670	1 100	
	440	80	2.1	705 000	2 080 000	72 000	212 000	630	1 000	

Remarks If a full complement roller bearing is required, please contact NSK.

Numbers With Inner Ring	Boundary Dimensions (mm)		Abutment and Fillet Dimensions (mm)			Mass (kg)	
	<i>d</i>	<i>B</i>	<i>d_a</i> min.	<i>D_a</i> max.	<i>r_a</i> max.	Without Inner Ring	With Inner Ring
NA 4922 NA 5922	110	40	116.5	143.5	1	1.25	2.1
	110	54	116.5	143.5	1	1.95	3.05
NA 4824	120	30	125	145	1	0.71	1.15
NA 4924 NA 5924	120	45	126.5	158.5	1	1.9	2.9
	120	60	126.5	158.5	1	2.7	4.05
NA 4826	130	35	136.5	158.5	1	0.92	1.8
NA 4926 NA 5926	130	50	138	172	1.5	2.3	4.0
	130	67	138	172	1.5	3.3	5.55
NA 4828	140	35	146.5	168.5	1	0.98	1.9
NA 4928 NA 5928	140	50	148	182	1.5	2.45	4.25
	140	67	148	182	1.5	3.55	6.0
NA 4830	150	40	156.5	183.5	1	1.6	2.75
NA 4832 NA 4834 NA 4836	160	40	166.5	193.5	1	1.75	2.95
	170	45	176.5	208.5	1	2.55	4.0
	180	45	186.5	218.5	1	2.65	4.2
NA 4838 NA 4840 NA 4844	190	50	198	232	1.5	3.2	5.6
	200	50	208	242	1.5	3.35	5.9
	220	50	228	262	1.5	3.65	6.45
NA 4848 NA 4852 NA 4856	240	60	249	291	2	5.45	10
	260	60	269	311	2	5.9	11
	280	69	289	341	2	9.5	15.5
NA 4860 NA 4864 NA 4868 NA 4872	300	80	311	369	2	13	22
	320	80	331	389	2	13.5	23.5
	340	80	351	409	2	14	24.5
	360	80	371	429	2	15	26

FNTA (Thrust Cage & Needle Roller Assemblies)

Thrust raceway washers

FTRA (s=1.0)

FTRB (s=1.5)

FTRC (s=2.0)

FTRD (s=2.5)

FTRE (s=3.0)

Bore Diameter 10 – 100 mm

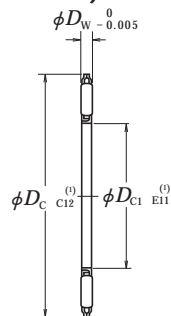

FNTA

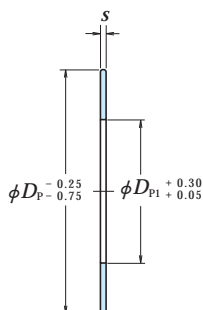

FTRA



FTRB



FTRC



FTRD



FTRE

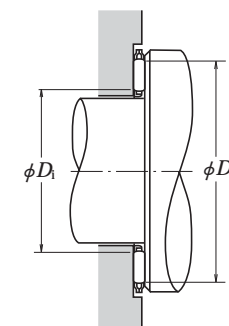

Boundary Dimensions (mm)				Basic Load Ratings				Limiting Speeds (min ⁻¹)	Bearing Numbers	s=1.0±0.05
D _{c1} , D _{p1}	D _c , D _p	D _w	(N)	(kgf)	C _a	C _{0a}	Oil			
10	24	2	7 750	23 000	790	2 350	17 000	FNTA-1024	*FTRA-1024	
12	26	2	8 350	26 300	855	2 680	16 000	FNTA-1226	FTRA-1226	
15	28	2	7 950	25 800	810	2 630	15 000	FNTA-1528	FTRA-1528	
16	29	2	8 200	27 100	835	2 770	14 000	FNTA-1629	FTRA-1629	
17	30	2	8 400	28 400	855	2 900	14 000	FNTA-1730	FTRA-1730	
18	31	2	8 600	29 700	875	3 050	13 000	FNTA-1831	FTRA-1831	
20	35	2	11 900	47 000	1 220	4 800	12 000	FNTA-2035	FTRA-2035	
25	42	2	14 800	66 000	1 510	6 750	9 500	FNTA-2542	FTRA-2542	
30	47	2	16 500	79 000	1 680	8 100	8 500	FNTA-3047	FTRA-3047	
35	52	2	17 300	88 000	1 770	8 950	8 000	FNTA-3552	FTRA-3552	
40	60	3	26 900	122 000	2 740	12 400	6 700	FNTA-4060	FTRA-4060	
45	65	3	28 700	137 000	2 930	14 000	6 300	FNTA-4565	FTRA-4565	
50	70	3	30 500	152 000	3 100	15 500	5 600	FNTA-5070	FTRA-5070	
55	78	3	37 000	201 000	3 750	20 500	5 300	FNTA-5578	FTRA-5578	
60	85	3	43 000	252 000	4 400	25 700	4 800	FNTA-6085	FTRA-6085	
65	90	3	45 500	274 000	4 600	28 000	4 500	FNTA-6590	FTRA-6590	
70	95	4	59 000	320 000	6 000	33 000	4 300	FNTA-7095	FTRA-7095	
75	100	4	60 000	335 000	6 150	34 500	4 000	FNTA-75100	FTRA-75100	
80	105	4	63 000	365 000	6 450	37 500	3 800	FNTA-80105	FTRA-80105	
85	110	4	64 500	380 000	6 550	39 000	3 600	FNTA-85110	FTRA-85110	
90	120	4	80 000	515 000	8 150	52 500	3 400	FNTA-90120	FTRA-90120	
100	135	4	98 500	695 000	10 000	71 000	3 000	FNTA-100135	FTRA-100135	

Bearing Numbers of Matching Bearing Rings				Roller Contact Surfaces (mm)		Mass (g)	
s=1.5 ⁰ _{-0.08}	s=2.0 ⁰ _{-0.08}	s=2.5 ⁰ _{-0.08}	s=3.0 ⁰ _{-0.08}	Outside Diameter D _e min.	Bore Diameter D _i max.	approx.	
FTRB-1024	FTRC-1024	—	—	22.0	11.5	2.3	2.9
FTRB-1226	FTRC-1226	—	—	24.0	13.5	3.4	3.3
FTRB-1528	FTRC-1528	FTRD-1528	FTRE-1528	26.0	16.5	3.5	3.5
FTRB-1629	FTRC-1629	FTRD-1629	FTRE-1629	27.0	17.5	3.7	3.6
FTRB-1730	FTRC-1730	FTRD-1730	FTRE-1730	28.0	18.5	3.8	3.8
FTRB-1831	FTRC-1831	FTRD-1831	FTRE-1831	29.0	19.5	4	3.9
FTRB-2035	FTRC-2035	FTRD-2035	FTRE-2035	33.0	21.5	5.4	5.1
FTRB-2542	FTRC-2542	FTRD-2542	FTRE-2542	40.0	26.5	7.7	7
FTRB-3047	FTRC-3047	FTRD-3047	FTRE-3047	45.0	31.5	8.9	7.9
FTRB-3552	FTRC-3552	FTRD-3552	FTRE-3552	50.5	36.5	9.7	9.1
FTRB-4060	FTRC-4060	FTRD-4060	FTRE-4060	57.0	42.0	18	12
FTRB-4565	FTRC-4565	FTRD-4565	FTRE-4565	62.0	47.0	20	13
FTRB-5070	FTRC-5070	FTRD-5070	FTRE-5070	67.0	51.5	22	15
FTRB-5578	FTRC-5578	FTRD-5578	FTRE-5578	75.0	57.0	29	19
FTRB-6085	FTRC-6085	FTRD-6085	FTRE-6085	82.0	61.5	35	22
FTRB-6590	FTRC-6590	FTRD-6590	FTRE-6590	87.5	66.5	38	24
FTRB-7095	FTRC-7095	FTRD-7095	FTRE-7095	92.5	71.5	52	25
FTRB-75100	FTRC-75100	FTRD-75100	FTRE-75100	97.5	76.5	54	27
FTRB-80105	FTRC-80105	FTRD-80105	FTRE-80105	102.5	81.5	58	28
FTRB-85110	FTRC-85110	FTRD-85110	FTRE-85110	107.5	86.5	63	30
FTRB-90120	FTRC-90120	FTRD-90120	FTRE-90120	117.5	91.5	80	38
FTRB-100135	FTRC-100135	FTRD-100135	FTRE-100135	132.5	101.5	105	50

Note (1) For tolerance classes C12 and E11, please refer to ISO 286-1 and 286-2 (ISO system of limits and fits), respectively.

(*) The tolerance of this bearing bore diameter is +0.025 to +0.175mm and outside diameter tolerance is -0.040 to -0.370mm

- FCR (Full Complement)
- FCRS (Full Complement, Sealed With Thrust Washer)
- FCJ (With Cage)
- FCJS (Sealed, with Cage and Thrust Washer)
- Outside Diameter 16 – 90 mm

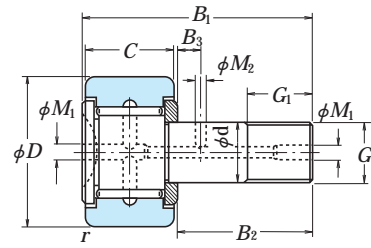

Full Complement

FCR

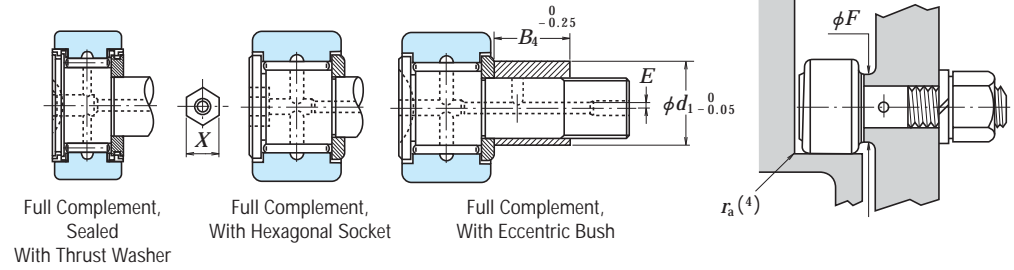

Full Complement, Sealed With Thrust Washer

FCRS

Full Complement, With Hexagonal Socket

FCRB

Full Complement, With Eccentric Bush

FCRE

Boundary Dimensions (mm)			Screw G	Dimensions (mm)							Bearing Numbers	
D	C	d		G ₁	B ₁	B ₂	B ₃	M ₂	M ₁	r _{min.}	FCR FCJ	FCRS FCJS
16	11	6	M 6×1	8	28	16	—	—	4 ⁽¹⁾	0.3	FCR-16	FCRS-16
	11	6	M 6×1	8	28	16	—	—	4 ⁽¹⁾	0.3	FCJ-16	FCJS-16
19	11	8	M 8×1.25	10	32	20	—	—	4 ⁽¹⁾	0.3	FCR-19	FCRS-19
	11	8	M 8×1.25	10	32	20	—	—	4 ⁽¹⁾	0.3	FCJ-19	FCJS-19
22	12	10	M10×1.25	12	36	23	—	—	4 ⁽¹⁾	0.3	FCR-22	FCRS-22
	12	10	M10×1.25	12	36	23	—	—	4 ⁽¹⁾	0.3	FCJ-22	FCJS-22
26	12	10	M10×1.25	12	36	23	—	—	4 ⁽¹⁾	0.3	FCR-26	FCRS-26
	12	10	M10×1.25	12	36	23	—	—	4 ⁽¹⁾	0.3	FCJ-26	FCJS-26
30	14	12	M12×1.5	13	40	25	6	3	6	0.6	FCR-30	FCRS-30
	14	12	M12×1.5	13	40	25	6	3	6	0.6	FCJ-30	FCJS-30
32	14	12	M12×1.5	13	40	25	6	3	6	0.6	FCR-32	FCRS-32
	14	12	M12×1.5	13	40	25	6	3	6	0.6	FCJ-32	FCJS-32
35	18	16	M16×1.5	17	52	32.5	8	3	6	0.6	FCR-35	FCRS-35
	18	16	M16×1.5	17	52	32.5	8	3	6	0.6	FCJ-35	FCJS-35
40	20	18	M18×1.5	19	58	36.5	8	3	6	1	FCR-40	FCRS-40
	20	18	M18×1.5	19	58	36.5	8	3	6	1	FCJ-40	FCJS-40
47	24	20	M20×1.5	21	66	40.5	9	4	8	1	FCR-47	FCRS-47
	24	20	M20×1.5	21	66	40.5	9	4	8	1	FCJ-47	FCJS-47
52	24	20	M20×1.5	21	66	40.5	9	4	8	1	FCR-52	FCRS-52
	24	20	M20×1.5	21	66	40.5	9	4	8	1	FCJ-52	FCJS-52
62	29	24	M24×1.5	25	80	49.5	11	4	8	1	FCR-62	FCRS-62
	29	24	M24×1.5	25	80	49.5	11	4	8	1	FCJ-62	FCJS-62
72	29	24	M24×1.5	25	80	49.5	11	4	8	1	FCR-72	FCRS-72
	29	24	M24×1.5	25	80	49.5	11	4	8	1	FCJ-72	FCJS-72
80	35	30	M30×1.5	32	100	63	15	4	8	1	FCR-80	FCRS-80
	35	30	M30×1.5	32	100	63	15	4	8	1	FCJ-80	FCJS-80
85	35	30	M30×1.5	32	100	63	15	4	8	1	FCR-85	FCRS-85
	35	30	M30×1.5	32	100	63	15	4	8	1	FCJ-85	FCJS-85
90	35	30	M30×1.5	32	100	63	15	4	8	1	FCR-90	FCRS-90
	35	30	M30×1.5	32	100	63	15	4	8	1	FCJ-90	FCJS-90

Notes ⁽¹⁾ Only the head of the stud has on oil hole.

⁽²⁾ Applicable to FCRB only.

Remarks Standard grease is packed in sealed cam followers, but not in cam followers without seals.

Basic Dynamic Load Ratings (N)		Limiting Loads (N)		Limiting Track Loads (N)		Mass (kg)	Dimensions of Hexagonal Socket ⁽³⁾ (width across flats) (mm) X	Eccentric Bush Dimensions ⁽²⁾ (mm)			Shoulder Dimensions (mm) F (min.)	Tightening Torque (N-cm) (kgf-cm)	
C _r	(kgf)	P _{max}	(kgf)	(N)	(kgf)			B ₄	d ₁	E		(max.)	(max.)
5 800	590	2 360	240	3 350	340	0.020	4	8	9	0.5	11	226	23
	2 830											288	2 360
6 600	670	4 200	425	4 150	425	0.031	4	10	11	0.5	13	550	56
	3 450											355	4 200
8 550	875	6 550	665	5 300	540	0.047	5	11	13	0.5	15	1 060	108
	4 350											445	6 550
8 550	875	6 550	665	6 000	610	0.060	5	11	13	0.5	15	1 060	108
	4 350											445	6 550
12 500	1 280	9 250	945	7 800	795	0.088	6	12	17	1	20	1 450	148
	7 200											735	9 250
12 500	1 280	9 250	945	8 050	820	0.099	6	12	17	1	20	1 450	148
	7 200											735	9 250
18 600	1 900	17 000	1 740	11 800	1 200	0.17	10	15.5	22	1	24	4 000	410
	9 700											990	17 000
20 500	2 090	21 700	2 220	14 300	1 460	0.25	10	17.5	24	1	26	5 950	605
	10 300											1 050	21 700
28 200	2 880	26 400	2 690	20 800	2 120	0.39	12	19.5	27	1	31	8 450	860
	19 200											1 950	26 400
28 200	2 880	26 400	2 690	22 900	2 340	0.47	12	19.5	27	1	31	8 450	860
	19 200											1 950	26 400
40 000	4 100	38 500	3 950	34 000	3 450	0.80	14	24.5	34	1	45	15 200	1 550
	24 900											2 540	38 500
40 000	4 100	38 500	3 950	38 000	3 860	1.05	14	24.5	34	1	45	15 200	1 550
	24 900											2 540	38 500
60 500	6 200	61 000	6 200	52 000	5 300	1.55	17	31	40	1.5	52	30 500	3 120
	39 000											4 000	61 000
60 500	6 200	61 000	6 200	55 500	5 650	1.75	17	31	40	1.5	52	30 500	3 120
	39 000											4 000	61 000
60 500	6 200	61 000	6 200	59 000	6 000	1.95	17	31	40	1.5	52	30 500	3 120
	39 000											4 000	61 000

Notes ⁽³⁾ Applicable to FCRE only.

⁽⁴⁾ Should not be greater than r (min).

- FYCR (Full Complement)
- FYCRS (Full Complement, Sealed with Thrust Washer)
- FYCJ (With Cage)
- FYCJS (Sealed, with Cage and Thrust Washer)
- Bore Diameter 5 – 50 mm

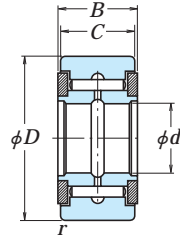

Full Complement

FYCR

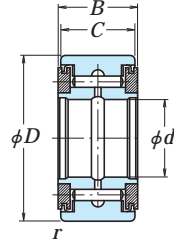

Full Complement, Sealed with Thrust Washer

FYCRS

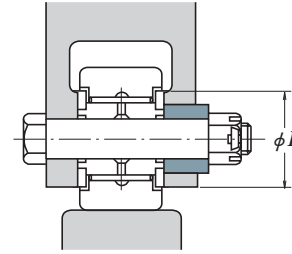

d	Boundary Dimensions (mm)				Basic Load Ratings (N)				Limiting Track Loads (N)	
	D	C	$B^{0.38}$	r min.	C_r	C_{0r}	C_r (kgf)	C_{0r} (kgf)	(N)	(kgf)
5	16	11	12	0.3	5 800	8 000	590	815	3 350	340
	16	11	12	0.3	2 830	2 620	288	267	3 350	340
6	19	11	12	0.3	6 550	9 900	665	1 010	4 150	425
	19	11	12	0.3	3 450	3 600	355	365	4 150	425
8	24	14	15	0.3	10 100	15 000	1 030	1 530	6 500	665
	24	14	15	0.3	5 700	6 000	580	610	6 500	665
10	30	14	15	0.6	11 700	18 500	1 190	1 890	7 800	795
	30	14	15	0.6	6 950	8 200	705	835	7 800	795
12	32	14	15	0.6	12 600	21 000	1 280	2 140	8 050	820
	32	14	15	0.6	7 650	9 650	780	985	8 050	820
15	35	18	19	0.6	18 700	29 300	1 910	2 990	11 800	1 200
	35	18	19	0.6	12 200	14 100	1 250	1 440	11 800	1 200
17	40	20	21	0.6	21 100	35 000	2 160	3 600	14 300	1 460
	40	20	21	0.6	13 700	16 700	1 390	1 700	14 300	1 460
20	47	24	25	1	28 900	50 000	2 940	5 100	20 800	2 120
	47	24	25	1	18 200	22 600	1 850	2 310	20 800	2 120
25	52	24	25	1	32 500	60 000	3 300	6 100	22 900	2 340
	52	24	25	1	22 200	31 000	2 270	3 150	22 900	2 340
30	62	28	29	1	47 500	96 000	4 800	9 800	33 000	3 350
	62	28	29	1	31 500	47 000	3 200	4 800	33 000	3 350
35	72	28	29	1	49 500	106 000	5 050	10 800	36 500	3 700
	72	28	29	1	33 000	52 500	3 400	5 350	36 500	3 700
40	80	30	32	1	54 500	126 000	5 600	12 800	43 500	4 450
	80	30	32	1	38 500	67 500	3 950	6 900	43 500	4 450
45	85	30	32	1	57 500	139 000	5 850	14 100	46 500	4 750
	85	30	32	1	40 000	73 000	4 100	7 450	46 500	4 750
50	90	30	32	1	60 500	152 000	6 150	15 500	49 500	5 050
	90	30	32	1	41 500	78 000	4 200	7 950	49 500	5 050

Remarks Standard grease is packed in sealed cam followers, but not in cam followers without seals.

Bearing Numbers		Mass (kg)	Shoulder Dimensions (mm)
FYCR FYCJ	FYCRS FYCJS	approx.	F min.
FYCR-5	FYCRS-5	0.016	10
FYCJ-5	FYCJS-5	0.014	10
FYCR-6	FYCRS-6	0.022	12
FYCJ-6	FYCJS-6	0.020	12
FYCR-8	FYCRS-8	0.044	14
FYCJ-8	FYCJS-8	0.042	14
FYCR-10	FYCRS-10	0.069	17
FYCJ-10	FYCJS-10	0.067	17
FYCR-12	FYCRS-12	0.076	19
FYCJ-12	FYCJS-12	0.074	19
FYCR-15	FYCRS-15	0.105	23
FYCJ-15	FYCJS-15	0.097	23
FYCR-17	FYCRS-17	0.145	25
FYCJ-17	FYCJS-17	0.14	25
FYCR-20	FYCRS-20	0.255	29
FYCJ-20	FYCJS-20	0.245	29
FYCR-25	FYCRS-25	0.285	34
FYCJ-25	FYCJS-25	0.275	34
FYCR-30	FYCRS-30	0.48	51
FYCJ-30	FYCJS-30	0.47	51
FYCR-35	FYCRS-35	0.64	58
FYCJ-35	FYCJS-35	0.635	58
FYCR-40	FYCRS-40	0.88	66
FYCJ-40	FYCJS-40	0.865	66
FYCR-45	FYCRS-45	0.93	72
FYCJ-45	FYCJS-45	0.91	72
FYCR-50	FYCRS-50	0.995	76
FYCJ-50	FYCJS-50	0.965	76

BALL BEARING UNITS

SET SCREW TYPE PILLOW BLOCKS CAST HOUSING

UCP2 Shaft Diameter 12 – 90mm B286
1/2 – 3 1/2 inch

SET SCREW TYPE FLANGED UNITS CAST HOUSING

UCF2 Shaft Diameter 12 – 90mm B292
1/2 – 3 1/2 inch

UCFL2 Shaft Diameter 12 – 90mm B298
1/2 – 3 1/2 inch



1. CONSTRUCTION

The NSK bearing unit is a combination of a radial ball bearing, seal, and a housing of high-grade cast iron or pressed steel, which comes in various shapes.

The outer surface of the bearing and the internal surface of the housing are spherical, so that the unit is self-aligning.

The inside construction of the ball bearing for the unit is such that steel balls and retainers of the same type as in series 62 and 63 of the deep groove ball bearing are used. A duplex seal consisting of a combination of an oil-proof synthetic rubber seal and

a slinger is provided on both sides.

Depending on the type, the following methods of fitting to the shaft are employed:

- (1) The inner ring is fastened onto the shaft in two places by set screws.
- (2) The inner ring has a tapered bore and is fitted to the shaft by means of an adapter.
- (3) In the eccentric locking collar system the inner ring is fastened to the shaft by means of eccentrics grooves provided at the side of the inner ring and on the collar.

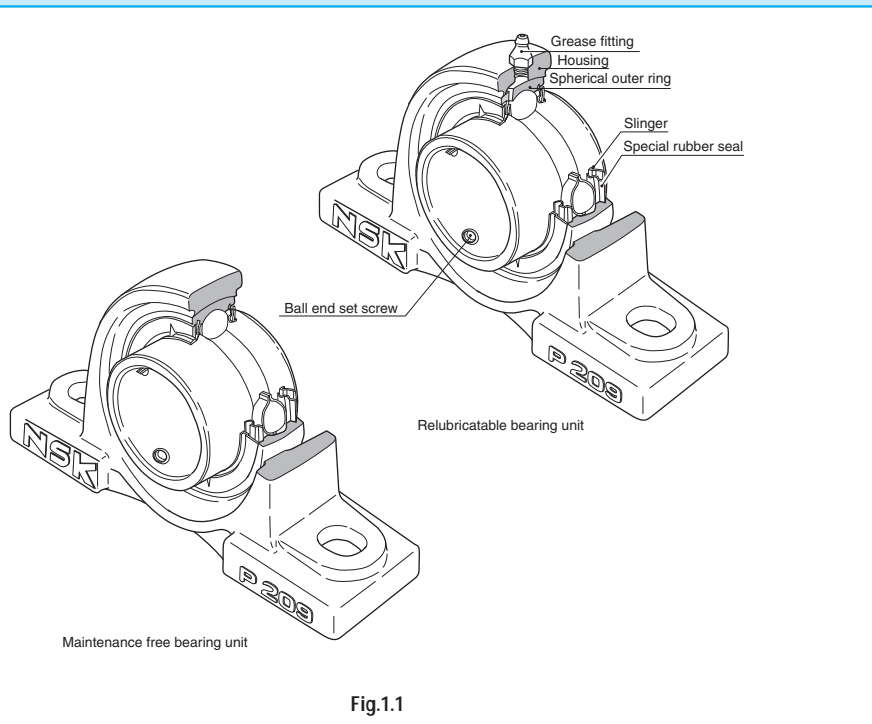

Fig.1.1

2. DESIGN FEATURES AND ADVANTAGES

2.1 MAINTENANCE FREE TYPE

The NSK Maintenance free bearing unit contains a high-grade lithium-based grease, good for use over a long period, which is ideally suited to sealed-type bearing. Also provided is an excellent sealing device, which prevents any leakage of grease or penetration of dust and water from outside.

It is designed so that the rotation of the shaft causes the sealed-in grease to circulate through the inside space, effectively providing maximum lubrication. The lubrication effect is maintained over a long period with no need for replenishment of grease.

To summarize the advantages of the NSK maintenance free bearing unit:

- (1) As an adequate amount of good quality grease is sealed in at the time of manufacture, there is no need for replenishment. This means savings in terms of time and maintenance costs.
- (2) Since there is no need for any regreasing facilities, such as piping, a more compact design is possible.
- (3) The sealed-in design eliminates the possibility of grease leakage, which could lead to stained products.

2.2 RELUBRICATABLE TYPE

The NSK relubricatable type bearing unit has an advantage over other similar units being so designed as to permit regreasing even in the case of misalignment of 2° to the right or left. The hole through which the grease fitting is mounted usually causes structural weakening of the housing.

However, as a result of extensive testing, in the NSK bearing unit the hole is positioned so as to minimize this adverse effect. In addition, the regreasing groove has been designed to minimize weakening of the housing.

While the NSK maintenance free type bearing unit is satisfactory for use under normal operating conditions in-doors, in the following circumstances it is necessary to use the relubricatable type bearing unit:

- (1) Cases where the temperature of the bearing rises above 100°C , 212°F :
* -Normal temperature of up to 130°C , 266°F heat-resistant bearing units.
- (2) Cases where there is excessive dust, but space does not permit using a bearing unit with a cover.
- (3) Cases where the bearing unit is constantly exposed to splashes of water or any other liquid, but space does not permit using a bearing unit with a cover.
- (4) Cases in which the humidity is very high, and the machine in which the bearing unit is used is run only intermittently.

- (5) Cases involving a heavy load of which the Cr/Pr value is about 10 or below, and the speed is 10 min^{-1} or below, or the movement is oscillatory.
- (6) Cases where the number of revolutions is relatively high and the noise problem has to be considered; for example, when the bearing is used with the fan of an air conditioner.

2.3 SPECIAL SEALING FEATURE

2.3.1 STANDARD BEARING UNITS

The sealing device of the ball bearing for the NSK bearing unit is a combination of a heat-resistant and oil-proof synthetic rubber seal and a slinger of an exclusive design.

The seal, which is fixed in the outer ring, is steel-reinforced, and its lip, in contact with the inner ring, is designed to minimize frictional torque.

The slinger is fixed to the inner ring of the bearing with which it rotates. There is a small clearance between its periphery and the outer ring.

There are triangular protrusions on the outside face of the slinger and, as the bearing rotates, these protrusions on the slinger create a flow of air outward from the bearing. In this way, the slinger acts as a fan which keeps dust and water away from the bearing.

These two types of seals on both sides of the bearing prevent grease leakage, and foreign matter is prevented from entering the bearing from outside.

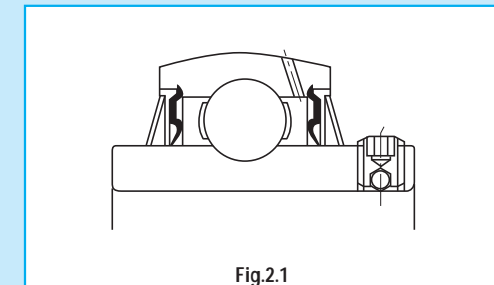

Fig.2.1

2.3.2 BEARING UNITS WITH COVERS

The NSK bearing unit with a cover consists of a standard bearing unit and an outside covering for extra protection against dust. Special consideration has been given to its design with respect to dust-proofing.

Sealing devices are provided in both the bearing and the housing, so that units of this type operate satisfactorily even in such adverse environments as flour mills, steel mills, foundries, galvanizing plants and chemical plants, where excessive dust is produced and/or liquids are used. They are also eminently suitable for outdoor environments where dust and rain are inevitable, and in heavy industrial machinery such as construction and transportation equipment.

The rubber seal of the cover contacts with the shaft by its two lips, as shown in Fig. 2.2 and 2.3. By filling the groove between the two lips with grease, an excellent sealing effect is obtained and, at the same time, the contacting portions of the lips are lubricated. Furthermore, the groove is so designed that when the shaft is inclined the rubber seal can move in the radial direction.

When bearing units are exposed to splashes of water rather than to dust, a drain hole (5 to 8 mm, 0.2 to 0.3 inches in diameter) is provided at the bottom of the cover, and grease should be applied to the side of the bearing itself instead of into the cover.

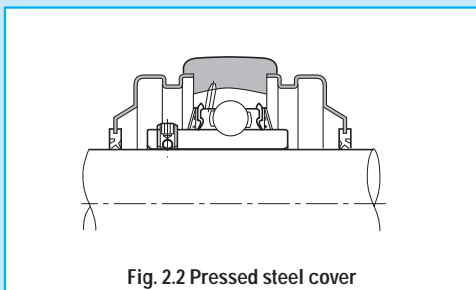

Fig. 2.2 Pressed steel cover

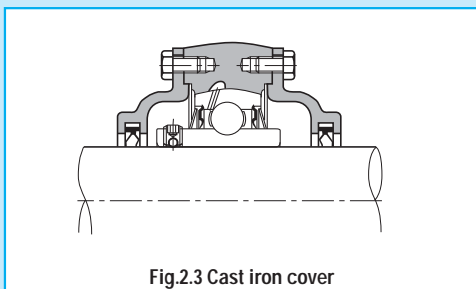

Fig. 2.3 Cast iron cover

2.4 SECURE FITTING

Fastening the bearing to the shaft is effected by tightening the ball-end set screw, situated on the inner ring. This is a unique feature which prevents loosening, even if the bearing is subject to intense vibrations and shocks.

2.5 SELF-ALIGNING

With the NSK bearing unit, the outer surface of the ball bearing and the inner surface of the housing are spherical, thus this bearing unit has self-aligning characteristic. Any misalignment of axis that arise from poor workmanship on the shaft or errors in fitting will be properly adjusted.

2.6 HIGHER RATED LOAD CAPACITY

The bearing used in the unit is of the same internal construction as those in bearing series 62 and 63, and is capable of accommodating axial load as well as radial load, or composite load. The rated load capacity of this bearing is considerably higher than that of the corresponding self-aligning ball bearings used for standard plummer blocks

2.7 LIGHT WEIGHT YET STRONG HOUSING

Housings for NSK bearing units come in various shapes. They consist of either high-grade cast iron, one-piece casting, or of precision finished pressed steel, the latter being lighter in weight. In either case, they are practically designed to combine lightness with maximum strength.

2.8 EASY MOUNTING

The NSK bearing unit is an integrated unit consisting of a bearing and a housing.

As the bearing is prelubricated at manufacture with the correct amount of high-grade lithium base, it can be mounted on the shaft just as it is. It is sufficient to carry out a short test run after mounting.

2.9 ACCURATE FITTING OF THE HOUSING

In order to simplify the fitting of the pillow block and flange type bearing units, the housings are provided with a seat for a dowel pin, which may be utilized as needed.

2.10 BEARING REPLACEABILITY

The bearing used in the NSK bearing unit is replaceable. In the event of bearing failure, a new bearing can be fitted to the existing housing.

3. RECOMMENDED TORQUES FOR TIGHTENING SET SCREWS

Table 3.1 Recommended torques for tightening set screws

A) Metric series, applied to metric bore size.

Designation of the bearings of applicable units			Designation of set screws	Tightening torques N·m (max.)
UC201 to UC205	—	—	M 5×0.8 × 7	3.9
UC206	—	UC305 to UC306	M 6×0.75× 8	4.9
UC207	UCX05	—	M 6×0.75× 8	5.8
UC208 to UC210	—	—	M 8×1 ×10	7.8
UC211	UCX06 to UCX08	UC307	M 8×1 ×10	9.8
UC212	UCX09	—	M10×1.25×12	16.6
UC213 to UC215	—	UC308 to UC309	M10×1.25×12	19.6
UC216	UCX10	—	M10×1.25×12	22.5
—	UCX11 to UCX12	—	M10×1.25×12	24.5
UC217 to UC218	UCX13 to UCX15	UC310 to UC314	M12×1.5 ×13	29.4
—	UCX16 to UCX17	—	M12×1.5 ×13	34.3
—	UCX18	UC315 to UC316	M14×1.5 ×15	34.3
—	UCX20	UC317 to UC319	M16×1.5 ×18	53.9
—	—	UC320 to UC324	M18×1.5 ×20	58.8
—	—	UC326 to UC328	M20×1.5 ×25	78.4

Designation of the bearings of applicable units	Designation of set screws	Tightening torques N·m (max.)
AS201 to 205	M5×0.8 × 7	3.4
AS206	M6×0.75× 8	4.4
AS207	M6×0.75× 8	4.9
AS208	M8×1 ×10	6.8

B) Inch series, applied to inch bore size.

Designation of the bearings for the unit to which torques given are applicable			Designation of set screws	Tightening torques lbf·inch (max.)
UC201 to UC205	—	—	No.10 -32UNF	34
UC206	—	UC305 to UC306	1/4 -28UNF	43
UC207	UCX05	—	1/4 -28UNF	52
UC208 to UC210	—	—	5/16 -24UNF	69
UC211	UCX06 to UCX08	UC307	5/16 -24UNF	86
UC212	UCX09	—	3/8 -24UNF	147
UC213 to UC215	—	UC308 to UC309	3/8 -24UNF	173
UC216	UCX10	—	3/8 -24UNF	199
—	UCX11 to UCX12	—	3/8 -24UNF	216
UC217 to UC218	UCX13 to UCX15	UC310 to UC314	1/2 -20UNF	260
—	UCX16 to UCX17	—	1/2 -20UNF	303
—	UCX18	UC315 to UC316	9/16 -18UNF	303
—	UCX20	UC317 to UC318	5/8 -18UNF	477
—	—	UC320	5/8 -18UNF	520

Designation of the bearings for the unit to which torques given are applicable	Designation of set screws	Tightening torques lbf·inch (max.)
AS201 to 205	No 10-32UNF	30
AS206	1/4 -28UNF	39
AS207	1/4 -28UNF	43
AS208	5/16-24UNF	60

Pillow blocks units cast housing
Set screw type

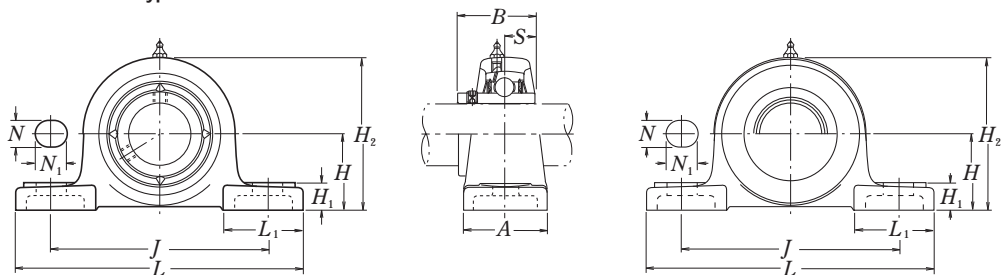

Pressed steel dust cover type
Open end Z-UCP...D1
Closed end ZM-UCP...D1

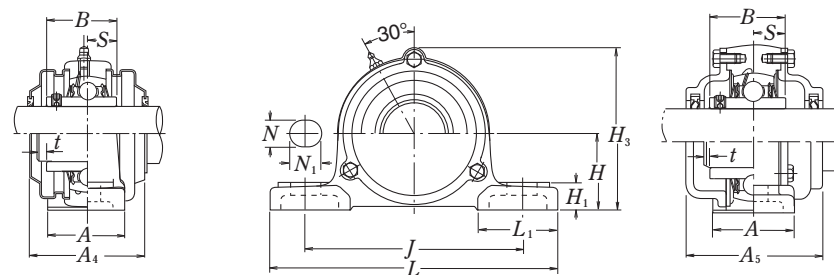

Cast dust cover type
Open end C-UCP...D1
Closed end CM-UCP...D1

Shaft dia. mm inch	Unit number (1)	Nominal dimensions											Bolt size mm inch	Bearing number
		mm inch												
		H	L	J	A	N	N ₁	H ₁	H ₂	L ₁	B	S		
12 1/2	UCP201D1 UCP201-008D1	30.2 1 3/16	127 5	95 3 3/4	38 1 1/2	13 1/2	16 5/8	14 9/16	62 2 7/16	42 1 21/32	31 1.2205	12.7 0.500	M10 3/8	UC201D1 UC201-008D1
15 9/16 5/8	UCP202D1 UCP202-009D1 UCP202-010D1	30.2 1 3/16	127 5	95 3 3/4	38 1 1/2	13 1/2	16 5/8	14 9/16	62 2 7/16	42 1 21/32	31 1.2205	12.7 0.500	M10 3/8	UC202D1 UC202-009D1 UC202-010D1
17 1 1/16	UCP203D1 UCP203-011D1	30.2 1 3/16	127 5	95 3 3/4	38 1 1/2	13 1/2	16 5/8	14 9/16	62 2 7/16	42 1 21/32	31 1.2205	12.7 0.500	M10 3/8	UC203D1 UC203-011D1
20 3/4	UCP204D1 UCP204-012D1	33.3 1 5/16	127 5	95 3 3/4	38 1 1/2	13 1/2	16 5/8	14 9/16	65 2 9/16	42 1 21/32	31 1.2205	12.7 0.500	M10 3/8	UC204D1 UC204-012D1
25 1 3/16 7/8 1 5/16 1	UCP205D1 UCP205-013D1 UCP205-014D1 UCP205-015D1 UCP205-100D1	36.5 1 3/16	140 5 1/2	105 4 1/8	38 1 1/2	13 1/2	16 5/8	15 19/32	71 2 25/32	42 1 21/32	34.1 1.3425	14.3 0.563	M10 3/8	UC205D1 UC205-013D1 UC205-014D1 UC205-015D1 UC205-100D1
30 1 1/16 1 1/8 1 3/16 1 1/4	UCP206D1 UCP206-101D1 UCP206-102D1 UCP206-103D1 UCP206-104D1	42.9 1 11/16	165 6 1/2	121 4 3/4	48 1 7/8	17 2 1/32	20 25/32	17 2 1/32	83 3 9/32	54 2 1/8	38.1 1.5000	15.9 0.626	M14 1/2	UC206D1 UC206-101D1 UC206-102D1 UC206-103D1 UC206-104D1
35 1 1/4 1 5/16 1 3/8 1 7/16	UCP207D1 UCP207-104D1 UCP207-105D1 UCP207-106D1 UCP207-107D1	47.6 1 1/4	167 6 9/16	127 5	48 1 7/8	17 2 1/32	20 25/32	18 23/32	93 3 21/32	54 2 1/8	42.9 1.6890	17.5 0.689	M14 1/2	UC207D1 UC207-104D1 UC207-105D1 UC207-106D1 UC207-107D1
40 1 1/2 1 9/16	UCP208D1 UCP208-108D1 UCP208-109D1	49.2 1 15/16	184 7 1/4	137 5 13/32	54 2 1/8	17 2 1/32	20 25/32	18 23/32	98 3 27/32	52 2 1/16	49.2 1.9370	19 0.748	M14 1/2	UC208D1 UC208-108D1 UC208-109D1

Note (1) These numbers indicate relubricatable type. If maintenance free type is needed, please order without suffix "D1".

Housing number	Unit number (1) pressed steel dust cover type	Unit number (1) cast dust cover type	Nominal dimensions				Mass of unit		
			t max.	A ₄	H ₃	A ₅	UCP	Z(ZM)	C(CM)
			mm inch			kg lb			
P203D1 P203D1	Z(ZM)-UCP201D1 Z(ZM)-UCP201-008D1	C(CM)-UCP201D1 C(CM)-UCP201-008D1	2 5/64	45 1 25/32	67 2 5/8	62 2 7/16	0.7 1.5	0.7 1.5	1.0 2.2
P203D1 P203D1 P203D1	Z(ZM)-UCP202D1 Z(ZM)-UCP202-009D1 Z(ZM)-UCP202-010D1	C(CM)-UCP202D1 C(CM)-UCP202-009D1 C(CM)-UCP202-010D1	2 5/64	45 1 25/32	67 2 5/8	62 2 7/16	0.7 1.5	0.7 1.5	1.0 2.2
P203D1 P203D1	Z(ZM)-UCP203D1 Z(ZM)-UCP203-011D1	C(CM)-UCP203D1 C(CM)-UCP203-011D1	2 5/64	45 1 25/32	67 2 5/8	62 2 7/16	0.7 1.5	0.7 1.5	1.0 2.2
P204D1 P204D1	Z(ZM)-UCP204D1 Z(ZM)-UCP204-012D1	C(CM)-UCP204D1 C(CM)-UCP204-012D1	2 5/64	45 1 25/32	70 2 3/4	62 2 7/16	0.7 1.5	0.7 1.5	0.9 2.0
P205D1 P205D1 P205D1 P205D1 P205D1	Z(ZM)-UCP205D1 Z(ZM)-UCP205-013D1 Z(ZM)-UCP205-014D1 Z(ZM)-UCP205-015D1 Z(ZM)-UCP205-100D1	C(CM)-UCP205D1 C(CM)-UCP205-013D1 C(CM)-UCP205-014D1 C(CM)-UCP205-015D1 C(CM)-UCP205-100D1	2 5/64	48 1 29/32	76 3	70 2 3/4	0.8 1.8	0.9 2.0	1.1 2.4
P206D1 P206D1 P206D1 P206D1 P206D1	Z(ZM)-UCP206D1 Z(ZM)-UCP206-101D1 Z(ZM)-UCP206-102D1 Z(ZM)-UCP206-103D1 —	C(CM)-UCP206D1 C(CM)-UCP206-101D1 C(CM)-UCP206-102D1 C(CM)-UCP206-103D1 —	2 5/64	53 2 3/32	88 3 15/32	75 2 15/16	1.4 3.1	1.4 3.1	1.7 3.7
P207D1 P207D1 P207D1 P207D1 P207D1	Z(ZM)-UCP207D1 Z(ZM)-UCP207-104D1 Z(ZM)-UCP207-105D1 Z(ZM)-UCP207-106D1 —	C(CM)-UCP207D1 C(CM)-UCP207-104D1 C(CM)-UCP207-105D1 C(CM)-UCP207-106D1 —	3 1/8	60 2 3/8	99 3 29/32	80 3 5/32	1.6 3.5	1.7 3.7	2.0 4.4
P208D1 P208D1 P208D1	Z(ZM)-UCP208D1 Z(ZM)-UCP208-108D1 Z(ZM)-UCP208-109D1	C(CM)-UCP208D1 C(CM)-UCP208-108D1 C(CM)-UCP208-109D1	3 1/8	69 2 23/32	105 4 1/8	90 3 17/32	1.9 4.2	2.1 4.6	2.7 6.0

Pillow blocks units cast housing
Set screw type

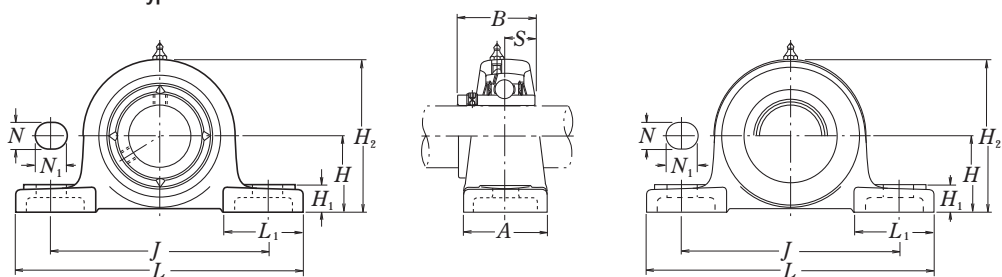

Pressed steel dust cover type
Open end Z-UCP...D1
Closed end ZM-UCP...D1

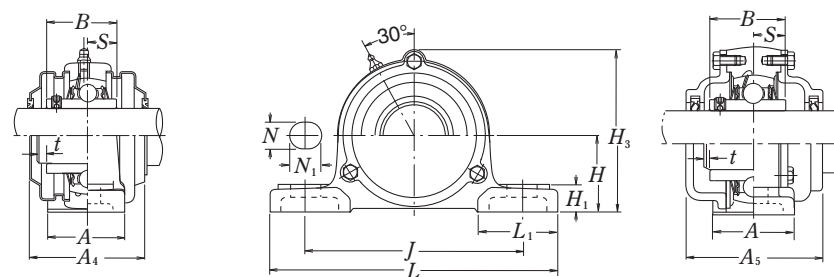

Cast dust cover type
Open end C-UCP...D1
Closed end CM-UCP...D1

Shaft dia. mm inch	Unit number ⁽¹⁾	Nominal dimensions											Bolt size mm inch	Bearing number
		H	L	J	A	N	N ₁	H ₁	H ₂	L ₁	B	S		
45 15/8 111/16 13/4	UCP209D1 UCP209-110D1 UCP209-111D1 UCP209-112D1	54 2 1/8	190 7 15/32	146 5 3/4	54 2 1/8	17 21/32	20 25/32	20 25/32	106 4 3/16	60 2 3/8	49.2 1.9370	19 0.748	M14 1/2	UC209D1 UC209-110D1 UC209-111D1 UC209-112D1
50 1 13/16 17/8 1 15/16 2	UCP210D1 UCP210-113D1 UCP210-114D1 UCP210-115D1 UCP210-200D1	57.2 2 1/4	206 8 1/8	159 6 1/4	60 2 3/8	20 25/32	23 29/32	21 13/16	114 4 1/2	65 2 9/16	51.6 2.0315	19 0.748	M16 5/8	UC210D1 UC210-113D1 UC210-114D1 UC210-115D1 UC210-200D1
55 2 2 1/16 2 1/8 2 3/16	UCP211D1 UCP211-200D1 UCP211-201D1 UCP211-202D1 UCP211-203D1	63.5 2 1/2	219 8 5/8	171 6 23/32	60 2 3/8	20 25/32	23 29/32	23 29/32	126 4 31/32	65 2 9/16	55.6 2.1890	22.2 0.874	M16 5/8	UC211D1 UC211-200D1 UC211-201D1 UC211-202D1 UC211-203D1
60 2 1/4 2 5/16 2 3/8 2 7/16	UCP212D1 UCP212-204D1 UCP212-205D1 UCP212-206D1 UCP212-207D1	69.8 2 3/4	241 9 1/2	184 7 1/4	70 2 3/4	20 25/32	23 29/32	25 31/32	138 5 7/16	70 2 3/4	65.1 2.5630	25.4 1.000	M16 5/8	UC212D1 UC212-204D1 UC212-205D1 UC212-206D1 UC212-207D1
65 2 1/2 2 9/16	UCP213D1 UCP213-208D1 UCP213-209D1	76.2 3	265 10 7/16	203 8	70 2 3/4	25 31/32	28 13/32	27 11/16	151 5 15/16	77 3 1/32	65.1 2.5630	25.4 1.000	M20 3/4	UC213D1 UC213-208D1 UC213-209D1
70 2 5/8 2 11/16 2 1/4	UCP214D1 UCP214-210D1 UCP214-211D1 UCP214-212D1	79.4 3 1/8	266 10 5/32	210 8 9/32	72 2 7/32	25 31/32	28 13/32	27 11/16	157 6 3/16	77 3 1/32	74.6 2.9370	30.2 1.189	M20 3/4	UC214D1 UC214-210D1 UC214-211D1 UC214-212D1

Note ⁽¹⁾ These numbers indicate relubricatable type. If maintenance free type is needed, please order without suffix "D1".

Housing number	Unit number ⁽¹⁾ pressed steel dust cover type	Unit number ⁽¹⁾ cast dust cover type	Nominal dimensions				Mass of unit		
			t max.	mm A ₄	inch H ₃	A ₅	kg UCP	lb Z(ZM)	C(CM)
P209D1 P209D1 P209D1 P209D1	Z(ZM)-UCP209D1 Z(ZM)-UCP209-110D1 Z(ZM)-UCP209-111D1 Z(ZM)-UCP209-112D1	C(CM)-UCP209D1 C(CM)-UCP209-110D1 C(CM)-UCP209-111D1 C(CM)-UCP209-112D1	3 1/8	69 2 23/32	113 4 7/16	95 3 3/4	2.2 4.9	2.4 5.3	3.1 6.8
P210D1 P210D1 P210D1 P210D1 P210D1 P210D1	Z(ZM)-UCP210D1 Z(ZM)-UCP210-113D1 Z(ZM)-UCP210-114D1 Z(ZM)-UCP210-115D1 —	C(CM)-UCP210D1 C(CM)-UCP210-113D1 C(CM)-UCP210-114D1 C(CM)-UCP210-115D1 C(CM)-UCP210-200D1	3 1/8	76 3	119 4 11/16	100 3 15/16	2.7 6.0	2.8 6.2	3.6 7.9
P211D1 P211D1 P211D1 P211D1 P211D1	Z(ZM)-UCP211D1 Z(ZM)-UCP211-200D1 Z(ZM)-UCP211-201D1 Z(ZM)-UCP211-202D1 Z(ZM)-UCP211-203D1	C(CM)-UCP211D1 C(CM)-UCP211-200D1 C(CM)-UCP211-201D1 C(CM)-UCP211-202D1 C(CM)-UCP211-203D1	4 5/32	77 3 1/32	130 5 1/8	100 3 15/16	3.5 7.7	3.5 7.7	4.4 9.7
P212D1 P212D1 P212D1 P212D1 P212D1	Z(ZM)-UCP212D1 Z(ZM)-UCP212-204D1 Z(ZM)-UCP212-205D1 Z(ZM)-UCP212-206D1 —	C(CM)-UCP212D1 C(CM)-UCP212-204D1 C(CM)-UCP212-205D1 C(CM)-UCP212-206D1 C(CM)-UCP212-207D1	4 5/32	89 3 1/2	143 5 5/8	115 4 17/32	4.7 10	5.0 11	6.0 13
P213D1 P213D1 P213D1	Z(ZM)-UCP213D1 Z(ZM)-UCP213-208D1 Z(ZM)-UCP213-209D1	C(CM)-UCP213D1 C(CM)-UCP213-208D1 C(CM)-UCP213-209D1	4 5/32	91 3 19/32	155 6 3/32	120 4 23/32	5.6 12	5.8 13	7.2 16
P214D1 P214D1 P214D1 P214D1	— — —	C(CM)-UCP214D1 C(CM)-UCP214-210D1 C(CM)-UCP214-211D1 C(CM)-UCP214-212D1	4 5/32	— 63/8	162 5 5/16	135	6.5 14	—	8.3 18

Pillow blocks units cast housing
Set screw type

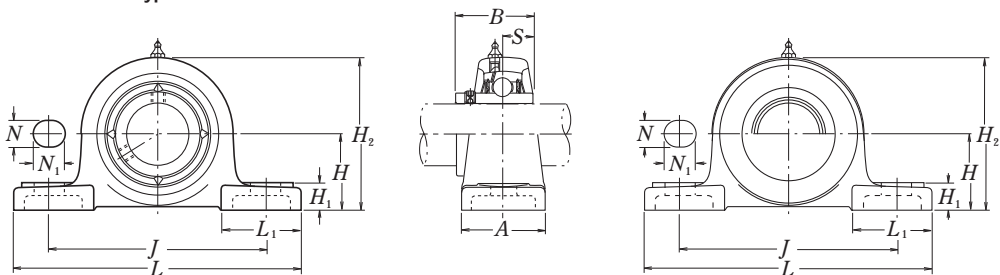

Pressed steel dust cover type
Open end Z-UCP...D1
Closed end ZM-UCP...D1

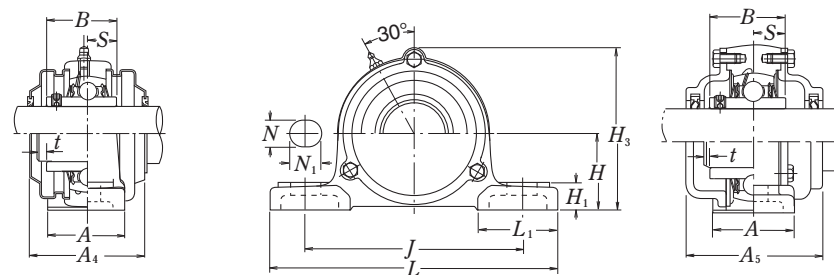

Cast dust cover type
Open end C-UCP...D1
Closed end CM-UCP...D1

Shaft dia. mm inch	Unit number ⁽¹⁾	Nominal dimensions											Bolt size mm inch	Bearing number
		H	L	J	A	N	N ₁	H ₁	H ₂	L ₁	B	S		
75	UCP215D1	82.6	275	217	74	25	28	28	163	80	77.8	33.3	M20	UC215D1
2 ¹³ / ₁₆	UCP215-213D1													UC215-213D1
27/8	UCP215-214D1	31/4	10 ¹³ / ₁₆	8 ¹⁷ / ₃₂	229/32	31/32	13/32	13/32	6 ¹³ / ₃₂	35/32	3.0630	1.311	3/4	UC215-214D1
2 ¹⁵ / ₁₆	UCP215-215D1													UC215-215D1
3	UCP215-300D1													UC215-300D1
80	UCP216D1	88.9	292	232	78	25	28	30	175	85	82.6	33.3	M20	UC216D1
31/16	UCP216-301D1													UC216-301D1
31/8	UCP216-302D1	31/2	11 ¹ / ₂	9 ¹ / ₈	3 ¹ / ₁₆	31/32	13/32	13/16	6 ⁷ / ₈	3 ¹¹ / ₃₂	3.2520	1.311	3/4	UC216-302D1
33/16	UCP216-303D1													UC216-303D1
85	UCP217D1	95.2	310	247	83	25	28	32	187	85	85.7	34.1	M20	UC217D1
31/4	UCP217-304D1													UC217-304D1
35/16	UCP217-305D1	33/4	12 ⁷ / ₃₂	9 ²³ / ₃₂	3 ⁹ / ₃₂	31/32	13/32	1 ¹ / ₄	7 ³ / ₈	3 ¹¹ / ₃₂	3.3740	1.343	3/4	UC217-305D1
37/16	UCP217-307D1													UC217-307D1
90	UCP218D1	101.6	327	262	88	27	30	33	200	90	96	39.7	M22	UC218D1
31/2	UCP218-308D1	4	12 ⁷ / ₈	10 ⁵ / ₁₆	3 ¹⁵ / ₃₂	1 ¹ / ₁₆	13/16	15/16	7 ⁷ / ₈	3 ¹⁷ / ₃₂	3.7795	1.563	7/8	UC218-308D1

Note ⁽¹⁾ These numbers indicate relubricatable type. If maintenance free type is needed, please order without suffix "D1".

Housing number	Unit number ⁽¹⁾ pressed steel dust cover type	Unit number ⁽¹⁾ cast dust cover type	Nominal dimensions				Mass of unit		
			t max.	mm A ₄	inch H ₃	A ₅	UCP	Z(ZM)	C(CM)
P215D1	—	C(CM)-UCP215D1	4	—	168	135	7.2	—	9.3
P215D1		C(CM)-UCP215-213D1							
P215D1		C(CM)-UCP215-214D1	5/32	—	65/8	55/16	16	—	21
P215D1		C(CM)-UCP215-215D1							
P215D1		C(CM)-UCP215-300D1							
P216D1	—	C(CM)-UCP216D1	4	—	181	145	8.7	—	11
P216D1		C(CM)-UCP216-301D1							
P216D1		C(CM)-UCP216-302D1	5/32	—	71/8	52 ³ / ₃₂	19	—	24
P216D1		C(CM)-UCP216-303D1							
P217D1	—	C(CM)-UCP217D1	5	—	191	155	11	—	13
P217D1		C(CM)-UCP217-304D1							
P217D1		C(CM)-UCP217-305D1	13/64	—	7 ¹⁷ / ₃₂	6 ³ / ₃₂	24	—	29
P217D1		C(CM)-UCP217-307D1							
P218D1	—	C(CM)-UCP218D1	5	—	204	165	13	—	16
P218D1		C(CM)-UCP218-308D1	13/64	—	8 ¹ / ₃₂	6 ¹ / ₂	29	—	35

Square flanged units cast housing
Set screw type

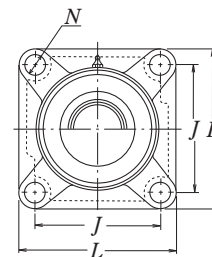
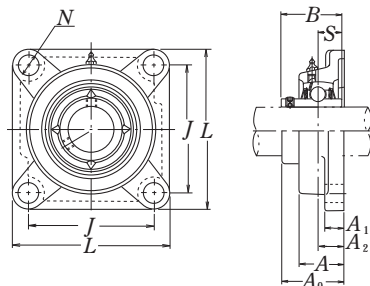

Pressed steel dust cover type
Open end Z-UCF...D1
Closed end ZM-UCF...D1

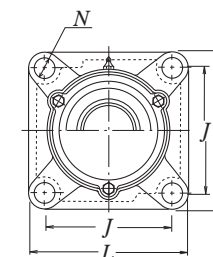

Cast dust cover type
Open end C-UCF...D1
Closed end CM-UCF...D1

Shaft dia.	Unit number ⁽¹⁾	Nominal dimensions										Bolt size	Bearing number
		mm inch											
		L	J	A ₂	A ₁	A	N	A ₀	B	S			
12	UCF201D1	86	64	15	11	25.5	12	33.3	31	12.7	M10	UC201D1	
1/2	UCF201-008D1	3 ³ / ₈	2 ³³ / ₆₄	19 ¹ / ₃₂	7 ¹ / ₁₆	1	15 ¹ / ₃₂	1 ⁵ / ₁₆	1.2205	0.500	3 ⁸ / ₈	UC201-008D1	
15	UCF202D1	86	64	15	11	25.5	12	33.3	31	12.7	M10	UC202D1	
9 ¹ / ₁₆	UCF202-009D1	3 ³ / ₈	2 ³³ / ₆₄	19 ¹ / ₃₂	7 ¹ / ₁₆	1	15 ¹ / ₃₂	1 ⁵ / ₁₆	1.2205	0.500	3 ⁸ / ₈	UC202-009D1	
5 ¹ / ₈	UCF202-010D1	3 ³ / ₈	2 ³³ / ₆₄	19 ¹ / ₃₂	7 ¹ / ₁₆	1	15 ¹ / ₃₂	1 ⁵ / ₁₆	1.2205	0.500	3 ⁸ / ₈	UC202-010D1	
17	UCF203D1	86	64	15	11	25.5	12	33.3	31	12.7	M10	UC203D1	
11 ¹ / ₁₆	UCF203-011D1	3 ³ / ₈	2 ³³ / ₆₄	19 ¹ / ₃₂	7 ¹ / ₁₆	1	15 ¹ / ₃₂	1 ⁵ / ₁₆	1.2205	0.500	3 ⁸ / ₈	UC203-011D1	
20	UCF204D1	86	64	15	11	25.5	12	33.3	31	12.7	M10	UC204D1	
3 ¹ / ₄	UCF204-012D1	3 ³ / ₈	2 ³³ / ₆₄	19 ¹ / ₃₂	7 ¹ / ₁₆	1	15 ¹ / ₃₂	1 ⁵ / ₁₆	1.2205	0.500	3 ⁸ / ₈	UC204-012D1	
25	UCF205D1	95	70	16	13	27	12	35.8	34.1	14.3	M10	UC205D1	
13 ¹ / ₁₆	UCF205-013D1	3 ³ / ₄	2 ³ / ₄	5 ¹ / ₈	1 ¹ / ₂	11 ¹ / ₁₆	15 ¹ / ₃₂	1 ¹³ / ₃₂	1.3425	0.563	3 ⁸ / ₈	UC205-013D1	
7 ¹ / ₈	UCF205-014D1	3 ³ / ₄	2 ³ / ₄	5 ¹ / ₈	1 ¹ / ₂	11 ¹ / ₁₆	15 ¹ / ₃₂	1 ¹³ / ₃₂	1.3425	0.563	3 ⁸ / ₈	UC205-014D1	
15 ¹ / ₁₆	UCF205-015D1	3 ³ / ₄	2 ³ / ₄	5 ¹ / ₈	1 ¹ / ₂	11 ¹ / ₁₆	15 ¹ / ₃₂	1 ¹³ / ₃₂	1.3425	0.563	3 ⁸ / ₈	UC205-015D1	
1	UCF205-100D1	3 ³ / ₄	2 ³ / ₄	5 ¹ / ₈	1 ¹ / ₂	11 ¹ / ₁₆	15 ¹ / ₃₂	1 ¹³ / ₃₂	1.3425	0.563	3 ⁸ / ₈	UC205-100D1	
30	UCF206D1	108	83	18	13	31	12	40.2	38.1	15.9	M10	UC206D1	
11 ¹ / ₁₆	UCF206-101D1	4 ¹ / ₄	3 ¹⁷ / ₆₄	4 ⁵ / ₆₄	1 ¹ / ₂	17 ¹ / ₃₂	15 ¹ / ₃₂	1 ³⁷ / ₆₄	1.5000	0.626	3 ⁸ / ₈	UC206-101D1	
11 ¹ / ₈	UCF206-102D1	4 ¹ / ₄	3 ¹⁷ / ₆₄	4 ⁵ / ₆₄	1 ¹ / ₂	17 ¹ / ₃₂	15 ¹ / ₃₂	1 ³⁷ / ₆₄	1.5000	0.626	3 ⁸ / ₈	UC206-102D1	
13 ¹ / ₁₆	UCF206-103D1	4 ¹ / ₄	3 ¹⁷ / ₆₄	4 ⁵ / ₆₄	1 ¹ / ₂	17 ¹ / ₃₂	15 ¹ / ₃₂	1 ³⁷ / ₆₄	1.5000	0.626	3 ⁸ / ₈	UC206-103D1	
11 ¹ / ₄	UCF206-104D1	4 ¹ / ₄	3 ¹⁷ / ₆₄	4 ⁵ / ₆₄	1 ¹ / ₂	17 ¹ / ₃₂	15 ¹ / ₃₂	1 ³⁷ / ₆₄	1.5000	0.626	3 ⁸ / ₈	UC206-104D1	
35	UCF207D1	117	92	19	15	34	14	44.4	42.9	17.5	M12	UC207D1	
11 ¹ / ₄	UCF207-104D1	4 ¹⁹ / ₃₂	3 ⁵ / ₈	3 ¹ / ₄	19 ¹ / ₃₂	11 ¹ / ₃₂	3 ⁵ / ₆₄	1 ¹³ / ₄	1.6890	0.689	7 ¹ / ₁₆	UC207-104D1	
15 ¹ / ₁₆	UCF207-105D1	4 ¹⁹ / ₃₂	3 ⁵ / ₈	3 ¹ / ₄	19 ¹ / ₃₂	11 ¹ / ₃₂	3 ⁵ / ₆₄	1 ¹³ / ₄	1.6890	0.689	7 ¹ / ₁₆	UC207-105D1	
13 ¹ / ₈	UCF207-106D1	4 ¹⁹ / ₃₂	3 ⁵ / ₈	3 ¹ / ₄	19 ¹ / ₃₂	11 ¹ / ₃₂	3 ⁵ / ₆₄	1 ¹³ / ₄	1.6890	0.689	7 ¹ / ₁₆	UC207-106D1	
17 ¹ / ₁₆	UCF207-107D1	4 ¹⁹ / ₃₂	3 ⁵ / ₈	3 ¹ / ₄	19 ¹ / ₃₂	11 ¹ / ₃₂	3 ⁵ / ₆₄	1 ¹³ / ₄	1.6890	0.689	7 ¹ / ₁₆	UC207-107D1	
40	UCF208D1	130	102	21	15	36	16	51.2	49.2	19	M14	UC208D1	
11 ¹ / ₂	UCF208-108D1	5 ¹ / ₈	4 ¹ / ₆₄	5 ³ / ₆₄	19 ¹ / ₃₂	11 ¹ / ₃₂	5 ¹ / ₈	2 ¹ / ₆₄	1.9370	0.748	1 ¹ / ₂	UC208-108D1	
19 ¹ / ₁₆	UCF208-109D1	5 ¹ / ₈	4 ¹ / ₆₄	5 ³ / ₆₄	19 ¹ / ₃₂	11 ¹ / ₃₂	5 ¹ / ₈	2 ¹ / ₆₄	1.9370	0.748	1 ¹ / ₂	UC208-109D1	

Note (1) These numbers indicate relubricatable type. If maintenance free type is needed, please order without suffix "D1".

Housing number	Unit number (1) pressed steel dust cover type	Unit number (1) cast dust cover type	Nominal dimensions			Mass of unit		
			mm inch			kg lb		
			t max.	A ₄	A ₅	UCP	Z(ZM)	C(CM)
F204D1	Z(ZM)-UCF201D1	C(CM)-UCF201D1	2	38	46	0.6	0.6	0.8
F204D1	Z(ZM)-UCF201-008D1	C(CM)-UCF201-008D1	5 ¹ / ₆₄	1 ¹ / ₂	1 ¹³ / ₁₆	1.3	1.3	1.8
F204D1	Z(ZM)-UCF202D1	C(CM)-UCF202D1	2	38	46	0.6	0.6	0.8
F204D1	Z(ZM)-UCF202-009D1	C(CM)-UCF202-009D1	5 ¹ / ₆₄	1 ¹ / ₂	1 ¹³ / ₁₆	1.3	1.3	1.8
F204D1	Z(ZM)-UCF202-010D1	C(CM)-UCF202-010D1	5 ¹ / ₆₄	1 ¹ / ₂	1 ¹³ / ₁₆	1.3	1.3	1.8
F204D1	Z(ZM)-UCF203D1	C(CM)-UCF203D1	2	38	46	0.6	0.6	0.8
F204D1	Z(ZM)-UCF203-011D1	C(CM)-UCF203-011D1	5 ¹ / ₆₄	1 ¹ / ₂	1 ¹³ / ₁₆	1.3	1.3	1.8
F204D1	Z(ZM)-UCF204D1	C(CM)-UCF204D1	2	38	46	0.6	0.6	0.7
F204D1	Z(ZM)-UCF204-012D1	C(CM)-UCF204-012D1	5 ¹ / ₆₄	1 ¹ / ₂	1 ¹³ / ₁₆	1.3	1.3	1.5
F205D1	Z(ZM)-UCF205D1	C(CM)-UCF205D1	2	40	51	0.8	0.8	0.9
F205D1	Z(ZM)-UCF205-013D1	C(CM)-UCF205-013D1	5 ¹ / ₆₄	1 ¹⁹ / ₃₂	2	1.8	1.8	2.0
F205D1	Z(ZM)-UCF205-014D1	C(CM)-UCF205-014D1	5 ¹ / ₆₄	1 ¹⁹ / ₃₂	2	1.8	1.8	2.0
F205D1	Z(ZM)-UCF205-015D1	C(CM)-UCF205-015D1	5 ¹ / ₆₄	1 ¹⁹ / ₃₂	2	1.8	1.8	2.0
F205D1	Z(ZM)-UCF205-100D1	C(CM)-UCF205-100D1	5 ¹ / ₆₄	1 ¹⁹ / ₃₂	2	1.8	1.8	2.0
F206D1	Z(ZM)-UCF206D1	C(CM)-UCF206D1	2	45	56	1.1	1.1	1.3
F206D1	Z(ZM)-UCF206-101D1	C(CM)-UCF206-101D1	5 ¹ / ₆₄	1 ³ / ₄	2 ⁷ / ₃₂	2.4	2.4	2.9
F206D1	Z(ZM)-UCF206-102D1	C(CM)-UCF206-102D1	5 ¹ / ₆₄	1 ³ / ₄	2 ⁷ / ₃₂	2.4	2.4	2.9
F206D1	Z(ZM)-UCF206-103D1	C(CM)-UCF206-103D1	5 ¹ / ₆₄	1 ³ / ₄	2 ⁷ / ₃₂	2.4	2.4	2.9
F206D1	Z(ZM)-UCF206-104D1	C(CM)-UCF206-104D1	5 ¹ / ₆₄	1 ³ / ₄	2 ⁷ / ₃₂	2.4	2.4	2.9
F207D1	Z(ZM)-UCF207D1	C(CM)-UCF207D1	3	49	59	1.5	1.5	1.8
F207D1	Z(ZM)-UCF207-104D1	C(CM)-UCF207-104D1	1 ¹ / ₈	1 ¹⁵ / ₁₆	2 ⁵ / ₁₆	3.3	3.3	4.0
F207D1	Z(ZM)-UCF207-105D1	C(CM)-UCF207-105D1	1 ¹ / ₈	1 ¹⁵ / ₁₆	2 ⁵ / ₁₆	3.3	3.3	4.0
F207D1	Z(ZM)-UCF207-106D1	C(CM)-UCF207-106D1	1 ¹ / ₈	1 ¹⁵ / ₁₆	2 ⁵ / ₁₆	3.3	3.3	4.0
F207D1	Z(ZM)-UCF207-107D1	C(CM)-UCF207-107D1	1 ¹ / ₈	1 ¹⁵ / ₁₆	2 ⁵ / ₁₆	3.3	3.3	4.0
F208D1	Z(ZM)-UCF208D1	C(CM)-UCF208D1	3	56	66	1.7	1.8	2.2
F208D1	Z(ZM)-UCF208-108D1	C(CM)-UCF208-108D1	1 ¹ / ₈	2 ³ / ₁₆	2 ¹⁹ / ₃₂	3.7	4.0	4.9
F208D1	Z(ZM)-UCF208-109D1	C(CM)-UCF208-109D1	1 ¹ / ₈	2 ³ / ₁₆	2 ¹⁹ / ₃₂	3.7	4.0	4.9

Square flanged units cast housing
Set screw type

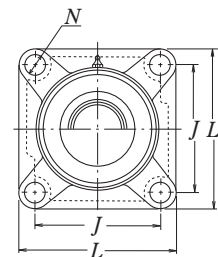
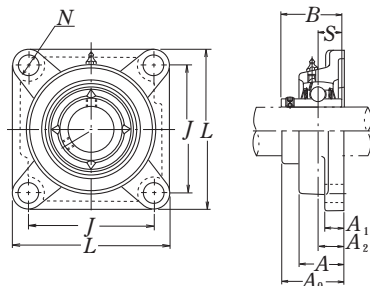

Pressed steel dust cover type
Open end Z-UCF...D1
Closed end ZM-UCF...D1

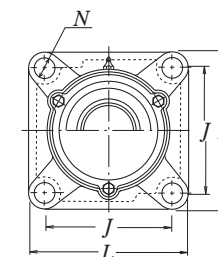

Cast dust cover type
Open end C-UCF...D1
Closed end CM-UCF...D1

Shaft dia.	Unit number ⁽¹⁾	Nominal dimensions									Bolt size	Bearing number
		mm inch										
mm inch		L	J	A ₂	A ₁	A	N	A ₀	B	S	mm inch	
45 1 5/8	UCF209D1	137	105	22	16	38	16	52.2	49.2	19	M14	UC209D1
111/16	UCF209-110D1	513/32	49/64	55/64	5/8	1 1/2	5/8	21/16	1.9370	0.748	1/2	UC209-110D1
13/4	UCF209-111D1											UC209-111D1
	UCF209-112D1											UC209-112D1
50 1 13/16	UCF210D1	143	111	22	16	40	16	54.6	51.6	19	M14	UC210D1
17/8	UCF210-113D1											UC210-113D1
115/16	UCF210-114D1	55/8	43/8	55/64	5/8	1 9/16	5/8	25/32	2.0315	0.748	1/2	UC210-114D1
2	UCF210-115D1											UC210-115D1
	UCF210-200D1											UC210-200D1
55 2	UCF211D1	162	130	25	18	43	19	58.4	55.6	22.2	M16	UC211D1
21/16	UCF211-200D1											UC211-200D1
21/8	UCF211-201D1	63/8	51/8	63/64	23/32	1 11/16	3/4	2 19/64	2.1890	0.874	5/8	UC211-201D1
23/16	UCF211-202D1											UC211-202D1
	UCF211-203D1											UC211-203D1
60 2 1/4	UCF212D1	175	143	29	18	48	19	68.7	65.1	25.4	M16	UC212D1
25/16	UCF212-204D1											UC212-204D1
23/8	UCF212-205D1	67/8	55/8	1 9/64	23/32	1 7/8	3/4	2 45/64	2.5630	1.000	5/8	UC212-205D1
27/16	UCF212-206D1											UC212-206D1
	UCF212-207D1											UC212-207D1
65 2 1/2	UCF213D1	187	149	30	22	50	19	69.7	65.1	25.4	M16	UC213D1
29/16	UCF213-208D1	73/8	5 55/64	13/16	7/8	1 31/32	3/4	2 3/4	2.5630	1.000	5/8	UC213-208D1
	UCF213-209D1											UC213-209D1
70 2 5/8	UCF214D1	193	152	31	22	54	19	75.4	74.6	30.2	M16	UC214D1
2 11/16	UCF214-210D1											UC214-210D1
23/4	UCF214-211D1	7 19/32	5 63/64	17/32	7/8	2 1/8	3/4	2 31/32	2.9370	1.189	5/8	UC214-211D1
	UCF214-212D1											UC214-212D1

Note (1) These numbers indicate relubricatable type. If maintenance free type is needed, please order without suffix "D1".

Housing number	Unit number ⁽¹⁾ pressed steel dust cover type	Unit number ⁽¹⁾ cast dust cover type	Nominal dimensions			Mass of unit		
			mm inch			kg lb		
			t max.	A ₄	A ₅	UCF	Z(ZM)	C(CM)
F209D1	Z(ZM)-UCF209D1	C(CM)-UCF209D1	3	57	70	2.1	2.2	2.6
F209D1	Z(ZM)-UCF209-110D1	C(CM)-UCF209-110D1						
F209D1	Z(ZM)-UCF209-111D1	C(CM)-UCF209-111D1	1/8	2 1/4	2 3/4	4.6	4.9	5.7
F209D1	Z(ZM)-UCF209-112D1	C(CM)-UCF209-112D1						
F210D1	Z(ZM)-UCF210D1	C(CM)-UCF210D1	3	60	72	2.5	2.5	3.0
F210D1	Z(ZM)-UCF210-113D1	C(CM)-UCF210-113D1						
F210D1	Z(ZM)-UCF210-114D1	C(CM)-UCF210-114D1	1/8	2 3/8	2 27/32	5.5	5.5	6.6
F210D1	Z(ZM)-UCF210-115D1	C(CM)-UCF210-115D1						
F210D1	—	C(CM)-UCF210-200D1						
F211D1	Z(ZM)-UCF211D1	C(CM)-UCF211D1	4	64	75	3.3	3.4	4.0
F211D1	Z(ZM)-UCF211-200D1	C(CM)-UCF211-200D1						
F211D1	Z(ZM)-UCF211-201D1	C(CM)-UCF211-201D1	5/32	2 1/2	2 15/16	7.3	7.5	8.8
F211D1	Z(ZM)-UCF211-202D1	C(CM)-UCF211-202D1						
F211D1	Z(ZM)-UCF211-203D1	C(CM)-UCF211-203D1						
F212D1	Z(ZM)-UCF212D1	C(CM)-UCF212D1	4	74	86	3.9	4.1	4.8
F212D1	Z(ZM)-UCF212-204D1	C(CM)-UCF212-204D1						
F212D1	Z(ZM)-UCF212-205D1	C(CM)-UCF212-205D1	5/32	2 29/32	3 3/8	8.6	9.0	11
F212D1	Z(ZM)-UCF212-206D1	C(CM)-UCF212-206D1						
F212D1	—	C(CM)-UCF212-207D1						
F213D1	Z(ZM)-UCF213D1	C(CM)-UCF213D1	4	76	90	5.5	5.6	6.4
F213D1	Z(ZM)-UCF213-208D1	C(CM)-UCF213-208D1	5/32	3	3 17/32	12	12	14
F213D1	Z(ZM)-UCF213-209D1	C(CM)-UCF213-209D1						
F214D1	—	C(CM)-UCF214D1	4	—	98	6.3	—	7.4
F214D1	—	C(CM)-UCF214-210D1						
F214D1	—	C(CM)-UCF214-211D1	5/32	—	3 27/32	14	—	16
F214D1	—	C(CM)-UCF214-212D1						

Square flanged units cast housing
Set screw type

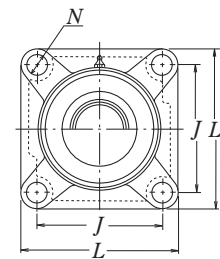
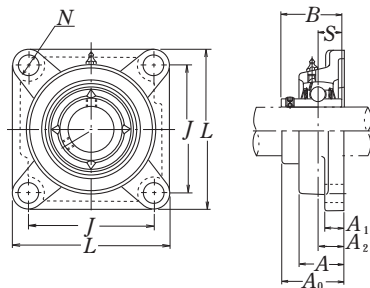

Pressed steel dust cover type
Open end Z-UCF...D1
Closed end ZM-UCF...D1

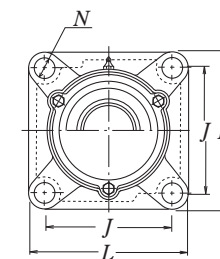

Cast dust cover type
Open end C-UCF...D1
Closed end CM-UCF...D1

Shaft dia.	Unit number ⁽¹⁾	Nominal dimensions									Bolt size	Bearing number
		mm inch										
mm inch		L	J	A ₂	A ₁	A	N	A ₀	B	S	mm inch	
75 2 ¹³ / ₁₆	UCF215D1 UCF215-213D1	200	159	34	22	56	19	78.5	77.8	33.3	M16	UC215D1 UC215-213D1
27/8	UCF215-214D1	77/8	6 ¹⁷ / ₆₄	1 ¹¹ / ₃₂	7/8	2 ⁷ / ₃₂	3/4	3 ³ / ₃₂	3.0630	1.311	5/8	UC215-214D1 UC215-215D1 UC215-300D1
215/16	UCF215-215D1											
3	UCF215-300D1											
80 31/16	UCF216D1 UCF216-301D1	208	165	34	22	58	23	83.3	82.6	33.3	M20	UC216D1 UC216-301D1
31/8	UCF216-302D1	8 ³ / ₁₆	6 ¹ / ₂	1 ¹¹ / ₃₂	7/8	2 ⁹ / ₃₂	29/32	3 ⁹ / ₃₂	3.2520	1.311	3/4	UC216-302D1 UC216-303D1
33/16	UCF216-303D1											
85 31/4	UCF217D1 UCF217-304D1	220	175	36	24	63	23	87.6	85.7	34.1	M20	UC217D1 UC217-304D1
35/16	UCF217-305D1	8 ²¹ / ₃₂	6 ⁵⁷ / ₆₄	1 ²⁷ / ₆₄	15/16	2 ¹⁵ / ₃₂	29/32	3 ²⁹ / ₆₄	3.3740	1.343	3/4	UC217-305D1 UC217-307D1
37/16	UCF217-307D1											
90 31/2	UCF218D1 UCF218-308D1	235	187	40	24	68	23	96.3	96	39.7	M20	UC218D1 UC218-308D1
		91/4	7 ²³ / ₆₄	1 ³⁷ / ₆₄	15/16	2 ¹¹ / ₁₆	29/32	3 ⁵¹ / ₆₄	3.7795	1.563	3/4	

Note (1) These numbers indicate relubricatable type. If maintenance free type is needed, please order without suffix "D1".

Housing number	Unit number (1) pressed steel dust cover type	Unit number (1) cast dust cover type	Nominal dimensions			Mass of unit		
			mm inch			kg lb		
			t max.	A ₄	A ₅	UCF	Z(ZM)	C(CM)
F215D1	—	C(CM)-UCF215D1 C(CM)-UCF215-213D1	4	—	102	6.6	—	7.9
F215D1	—	C(CM)-UCF215-214D1 C(CM)-UCF215-215D1 C(CM)-UCF215-300D1	5/32	—	4 ¹ / ₃₂	15	—	17
F216D1	—	C(CM)-UCF216D1 C(CM)-UCF216-301D1	4	—	106	7.9	—	9.3
F216D1	—	C(CM)-UCF216-302D1 C(CM)-UCF216-303D1	5/32	—	4 ³ / ₁₆	17	—	21
F217D1	—	C(CM)-UCF217D1 C(CM)-UCF217-304D1	5	—	114	9.8	—	12
F217D1	—	C(CM)-UCF217-305D1 C(CM)-UCF217-307D1	13/64	—	4 ¹ / ₂	22	—	26
F218D1	—	C(CM)-UCF218D1 C(CM)-UCF218-308D1	5	—	122	12	—	13
F218D1	—		13/64	—	4 ¹³ / ₁₆	26	—	29

Rhombus flanged units cast housing
Set screw type

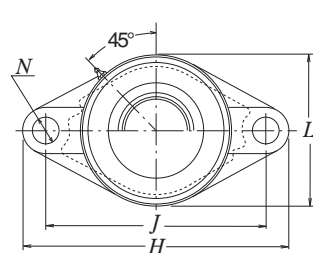
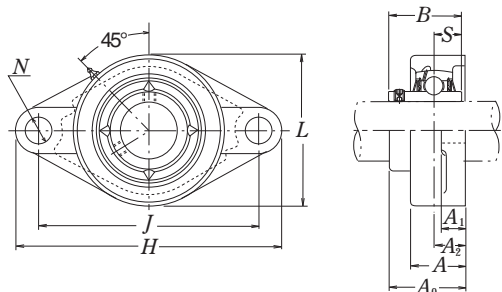

Pressed steel dust cover type
Open end Z-UCFL...D1
Closed end ZM-UCFL...D1

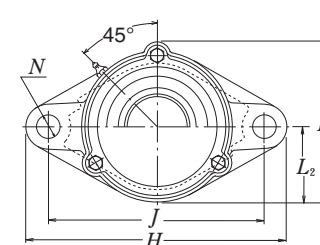
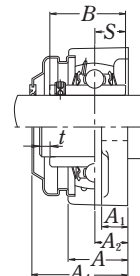

Cast dust cover type
Open end C-UCFL...D1
Closed end CM-UCFL...D1

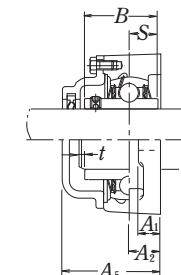

Shaft dia.	Unit number ⁽¹⁾	Nominal dimensions										Bolt size	Bearing number
		mm inch											
		H	J	A ₂	A ₁	A	N	L	A ₀	B	S		
12 1/2	UCFL201D1 UCFL201-008D1	113 47/16	90 335/64	15 19/32	11 7/16	25.5 1	12 15/32	60 23/8	33.3 15/16	31 1.2205	12.7 0.500	M10 3/8	UC201D1 UC201-008D1
15 9/16 5/8	UCFL202D1 UCFL202-009D1 UCFL202-010D1	113 47/16	90 335/64	15 19/32	11 7/16	25.5 1	12 15/32	60 23/8	33.3 15/16	31 1.2205	12.7 0.500	M10 3/8	UC202D1 UC202-009D1 UC202-010D1
17 11/16	UCFL203D1 UCFL203-011D1	113 47/16	90 335/64	15 19/32	11 7/16	25.5 1	12 15/32	60 23/8	33.3 15/16	31 1.2205	12.7 0.500	M10 3/8	UC203D1 UC203-011D1
20 3/4	UCFL204D1 UCFL204-012D1	113 47/16	90 335/64	15 19/32	11 7/16	25.5 1	12 15/32	60 23/8	33.3 15/16	31 1.2205	12.7 0.500	M10 3/8	UC204D1 UC204-012D1
25 13/16 7/8 15/16	UCFL205D1 UCFL205-013D1 UCFL205-014D1 UCFL205-015D1 UCFL205-100D1	130 51/8	99 357/64	16 5/8	13 1/2	27 11/16	16 5/8	68 211/16	35.8 113/32	34.1 1.3425	14.3 0.563	M14 1/2	UC205D1 UC205-013D1 UC205-014D1 UC205-015D1 UC205-100D1
30 11/16 11/8 13/16 11/4	UCFL206D1 UCFL206-101D1 UCFL206-102D1 UCFL206-103D1 UCFL206-104D1	148 513/16	117 439/64	18 45/64	13 1/2	31 17/32	16 5/8	80 35/32	40.2 137/64	38.1 1.5000	15.9 0.626	M14 1/2	UC206D1 UC206-101D1 UC206-102D1 UC206-103D1 UC206-104D1
35 11/4 15/16 13/8 17/16	UCFL207D1 UCFL207-104D1 UCFL207-105D1 UCFL207-106D1 UCFL207-107D1	161 611/32	130 51/8	19 3/4	15 19/32	34 111/32	16 5/8	90 317/32	44.4 13/4	42.9 1.6890	17.5 0.689	M14 1/2	UC207D1 UC207-104D1 UC207-105D1 UC207-106D1 UC207-107D1
40 11/2 19/16	UCFL208D1 UCFL208-108D1 UCFL208-109D1	175 67/8	144 543/64	21 53/64	15 19/32	36 113/32	16 5/8	100 315/16	51.2 21/64	49.2 1.9370	19 0.748	M14 1/2	UC208D1 UC208-108D1 UC208-109D1

Note (1) These numbers indicate relubricatable type. If maintenance free type is needed, please order without suffix "D1".

Housing number	Unit number (1) pressed steel dust cover type	Unit number (1) cast dust cover type	Nominal dimensions					Mass of unit		
			t max.	mm inch				kg lb		
				A ₄	A ₅	L ₁	L ₂	UCFL	Z(ZM)	C(CM)
FL204D1 FL204D1	Z(ZM)-UCFL201D1 Z(ZM)-UCFL201-008D1	C(CM)-UCFL201D1 C(CM)-UCFL201-008D1	2 5/64	38 11/2	46 113/16	67 25/8	30 13/16	0.5 1.1	0.5 1.1	0.6 1.3
FL204D1 FL204D1 FL204D1	Z(ZM)-UCFL202D1 Z(ZM)-UCFL202-009D1 Z(ZM)-UCFL202-010D1	C(CM)-UCFL202D1 C(CM)-UCFL202-009D1 C(CM)-UCFL202-010D1	2 5/64	38 11/2	46 113/16	67 25/8	30 13/16	0.5 1.1	0.5 1.1	0.6 1.3
FL204D1 FL204D1	Z(ZM)-UCFL203D1 Z(ZM)-UCFL203-011D1	C(CM)-UCFL203D1 C(CM)-UCFL203-011D1	2 5/64	38 11/2	46 113/16	67 25/8	30 13/16	0.5 1.1	0.5 1.1	0.6 1.3
FL204D1 FL204D1	Z(ZM)-UCFL204D1 Z(ZM)-UCFL204-012D1	C(CM)-UCFL204D1 C(CM)-UCFL204-012D1	2 5/64	38 11/2	46 113/16	67 25/8	30 13/16	0.4 0.9	0.4 0.9	0.6 1.3
FL205D1 FL205D1 FL205D1 FL205D1 FL205D1	Z(ZM)-UCFL205D1 Z(ZM)-UCFL205-013D1 Z(ZM)-UCFL205-014D1 Z(ZM)-UCFL205-015D1 Z(ZM)-UCFL205-100D1	C(CM)-UCFL205D1 C(CM)-UCFL205-013D1 C(CM)-UCFL205-014D1 C(CM)-UCFL205-015D1 C(CM)-UCFL205-100D1	2 5/64	40 119/32	51 2	74 229/32	34 111/32	0.6 1.3	0.6 1.3	0.8 1.8
FL206D1 FL206D1 FL206D1 FL206D1 FL206D1	Z(ZM)-UCFL206D1 Z(ZM)-UCFL206-101D1 Z(ZM)-UCFL206-102D1 Z(ZM)-UCFL206-103D1 —	C(CM)-UCFL206D1 C(CM)-UCFL206-101D1 C(CM)-UCFL206-102D1 C(CM)-UCFL206-103D1 —	2 5/64	45 13/4	56 27/32	85 311/32	40 19/16	0.9 2.0	0.9 2.0	1.2 2.6
FL207D1 FL207D1 FL207D1 FL207D1 FL207D1	Z(ZM)-UCFL207D1 Z(ZM)-UCFL207-104D1 Z(ZM)-UCFL207-105D1 Z(ZM)-UCFL207-106D1 —	C(CM)-UCFL207D1 C(CM)-UCFL207-104D1 C(CM)-UCFL207-105D1 C(CM)-UCFL207-106D1 —	3 1/8	49 115/16	59 25/16	97 313/16	45 125/32	1.2 2.6	1.2 2.6	1.4 3.1
FL208D1 FL208D1 FL208D1	Z(ZM)-UCFL208D1 Z(ZM)-UCFL208-108D1 Z(ZM)-UCFL208-109D1	C(CM)-UCFL208D1 C(CM)-UCFL208-108D1 C(CM)-UCFL208-109D1	3 1/8	56 23/16	66 219/32	106 43/16	50 131/32	1.5 3.3	1.5 3.3	1.9 4.2

Rhombus flanged units cast housing
Set screw type

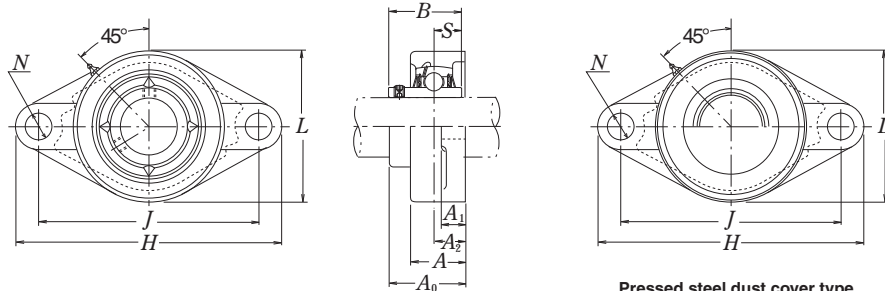

Pressed steel dust cover type
Open end Z-UCFL...D1
Closed end ZM-UCFL...D1

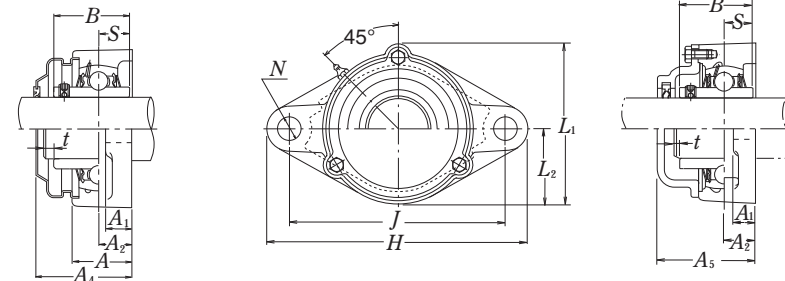

Cast dust cover type
Open end C-UCFL...D1
Closed end CM-UCFL...D1

Shaft dia.	Unit number ⁽¹⁾	Nominal dimensions											Bolt size	Bearing number
		mm inch												
		H	J	A ₂	A ₁	A	N	L	A ₀	B	S			
45	UCFL209D1	188	148	22	16	38	19	108	52.2	49.2	19	M16	UC209D1	
1 ⁵ / ₈	UCFL209-110D1												UC209-110D1	
1 ¹¹ / ₁₆	UCFL209-111D1	7 ¹³ / ₃₂	5 ⁵³ / ₆₄	5 ⁵ / ₆₄	5 ⁵ / ₈	1 ¹ / ₂	3 ³ / ₄	4 ¹ / ₄	2 ¹ / ₁₆	1.9370	0.748	5/8	UC209-111D1	
1 ³ / ₄	UCFL209-112D1												UC209-112D1	
50	UCFL210D1	197	157	22	16	40	19	115	54.6	51.6	19	M16	UC210D1	
1 ¹³ / ₁₆	UCFL210-113D1												UC210-113D1	
1 ⁷ / ₈	UCFL210-114D1	7 ³ / ₄	6 ³ / ₁₆	5 ⁵ / ₆₄	5 ⁵ / ₈	1 ⁹ / ₁₆	3 ³ / ₄	4 ¹⁷ / ₃₂	2 ⁵ / ₃₂	2.0315	0.748	5/8	UC210-114D1	
1 ¹⁵ / ₁₆	UCFL210-115D1												UC210-115D1	
2	UCFL210-200D1												UC210-200D1	
55	UCFL211D1	224	184	25	18	43	19	130	58.4	55.6	22.2	M16	UC211D1	
2	UCFL211-200D1												UC211-200D1	
2 ¹ / ₁₆	UCFL211-201D1	8 ¹³ / ₁₆	7 ¹ / ₄	6 ³ / ₆₄	2 ³ / ₃₂	1 ¹¹ / ₁₆	3 ³ / ₄	5 ¹ / ₈	2 ¹⁹ / ₆₄	2.1890	0.874	5/8	UC211-201D1	
2 ¹ / ₈	UCFL211-202D1												UC211-202D1	
2 ³ / ₁₆	UCFL211-203D1												UC211-203D1	
60	UCFL212D1	250	202	29	18	48	23	140	68.7	65.1	25.4	M20	UC212D1	
2 ¹ / ₄	UCFL212-204D1												UC212-204D1	
2 ⁵ / ₁₆	UCFL212-205D1	9 ²⁷ / ₃₂	7 ⁶¹ / ₆₄	1 ⁹ / ₆₄	2 ³ / ₃₂	1 ⁷ / ₈	2 ⁹ / ₃₂	5 ¹ / ₂	2 ⁴⁵ / ₆₄	2.5630	1.000	3/4	UC212-205D1	
2 ³ / ₈	UCFL212-206D1												UC212-206D1	
2 ⁷ / ₁₆	UCFL212-207D1												UC212-207D1	
65	UCFL213D1	258	210	30	22	50	23	155	69.7	65.1	25.4	M20	UC213D1	
2 ¹ / ₂	UCFL213-208D1												UC213-208D1	
2 ⁹ / ₁₆	UCFL213-209D1	10 ⁵ / ₃₂	8 ¹⁷ / ₆₄	1 ³ / ₁₆	7 ⁷ / ₈	1 ³¹ / ₃₂	2 ⁹ / ₃₂	6 ³ / ₃₂	2 ³ / ₄	2.5630	1.000	3/4	UC213-209D1	
70	UCFL214D1	265	216	31	22	54	23	160	75.4	74.6	30.2	M20	UC214D1	
2 ⁵ / ₈	UCFL214-210D1												UC214-210D1	
2 ¹¹ / ₁₆	UCFL214-211D1	10 ⁷ / ₁₆	8 ¹ / ₂	1 ⁷ / ₃₂	7 ⁷ / ₈	2 ¹ / ₈	2 ⁹ / ₃₂	6 ⁵ / ₁₆	2 ³¹ / ₃₂	2.9370	1.189	3/4	UC214-211D1	
2 ³ / ₄	UCFL214-212D1												UC214-212D1	

Note (1) These numbers indicate relubricatable type. If maintenance free type is needed, please order without suffix "D1".

Housing number	Unit number (1) pressed steel dust cover type	Unit number (1) cast dust cover type	Nominal dimensions					Mass of unit		
			mm inch					kg lb		
			t max.	A ₄	A ₅	L ₁	L ₂	UCFL	Z(ZM)	C(CM)
FL209D1	Z(ZM)-UCFL209D1	C(CM)-UCFL209D1	3	57	70	113	54	1.8	1.9	2.3
FL209D1	Z(ZM)-UCFL209-110D1	C(CM)-UCFL209-110D1								
FL209D1	Z(ZM)-UCFL209-111D1	C(CM)-UCFL209-111D1	1/8	2 ¹ / ₄	2 ³ / ₄	4 ⁷ / ₁₆	2 ¹ / ₈	4.0	4.2	5.1
FL209D1	Z(ZM)-UCFL209-112D1	C(CM)-UCFL209-112D1								
FL210D1	Z(ZM)-UCFL210D1	C(CM)-UCFL210D1	3	60	72	120	58	2.0	2.1	2.7
FL210D1	Z(ZM)-UCFL210-113D1	C(CM)-UCFL210-113D1								
FL210D1	Z(ZM)-UCFL210-114D1	C(CM)-UCFL210-114D1	1/8	2 ³ / ₈	2 ²⁷ / ₃₂	4 ²³ / ₃₂	2 ⁹ / ₃₂	4.4	4.6	6.0
FL210D1	Z(ZM)-UCFL210-115D1	C(CM)-UCFL210-115D1								
FL210D1	—	C(CM)-UCFL210-200D1								
FL211D1	Z(ZM)-UCFL211D1	C(CM)-UCFL211D1	4	64	75	133	65	2.9	3.0	3.4
FL211D1	Z(ZM)-UCFL211-200D1	C(CM)-UCFL211-200D1								
FL211D1	Z(ZM)-UCFL211-201D1	C(CM)-UCFL211-201D1	5/32	2 ¹ / ₂	2 ¹⁵ / ₁₆	5 ¹ / ₄	2 ⁹ / ₁₆	6.4	6.6	7.5
FL211D1	Z(ZM)-UCFL211-202D1	C(CM)-UCFL211-202D1								
FL211D1	Z(ZM)-UCFL211-203D1	C(CM)-UCFL211-203D1								
FL212D1	Z(ZM)-UCFL212D1	C(CM)-UCFL212D1	4	74	86	144	70	3.8	4.0	4.6
FL212D1	Z(ZM)-UCFL212-204D1	C(CM)-UCFL212-204D1								
FL212D1	Z(ZM)-UCFL212-205D1	C(CM)-UCFL212-205D1	5/32	2 ²⁹ / ₃₂	3 ³ / ₈	5 ²¹ / ₃₂	2 ³ / ₄	8.4	8.9	10
FL212D1	Z(ZM)-UCFL212-206D1	C(CM)-UCFL212-206D1								
FL212D1	—	C(CM)-UCFL212-207D1								
FL213D1	Z(ZM)-UCFL213D1	C(CM)-UCFL213D1	4	76	90	157	78	4.8	4.9	5.8
FL213D1	Z(ZM)-UCFL213-208D1	C(CM)-UCFL213-208D1	5/32	3	3 ¹⁷ / ₃₂	6 ³ / ₁₆	3 ¹ / ₁₆	11	11	15
FL213D1	Z(ZM)-UCFL213-209D1	C(CM)-UCFL213-209D1								
FL214D1	—	C(CM)-UCFL214D1	4	—	98	164	80	5.4	—	7.7
FL214D1	—	C(CM)-UCFL214-210D1								
FL214D1	—	C(CM)-UCFL214-211D1	5/32	—	3 ²⁷ / ₃₂	6 ¹⁵ / ₃₂	3 ⁵ / ₃₂	12	—	17
FL214D1	—	C(CM)-UCFL214-212D1								

Rhombus flanged units cast housing
Set screw type

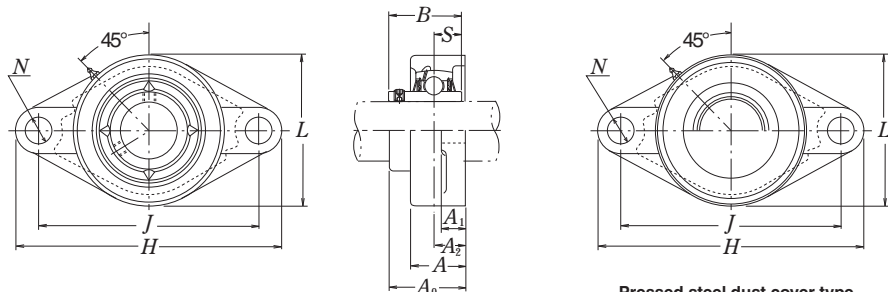

Pressed steel dust cover type
Open end Z-UCFL...D1
Closed end ZM-UCFL...D1

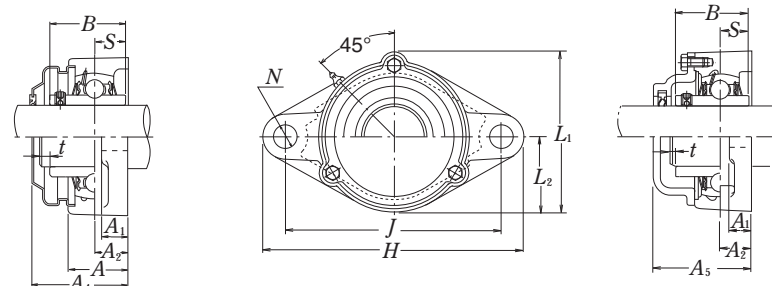

Cast dust cover type
Open end C-UCFL...D1
Closed end CM-UCFL...D1

Shaft dia.	Unit number ⁽¹⁾	Nominal dimensions											Bolt size	Bearing number
		mm inch												
mm		H	J	A ₂	A ₁	A	N	L	A ₀	B	S	mm		
inch												inch		
75	UCFL215D1	275	225	34	22	56	23	165	78.5	77.8	33.3	M20	UC215D1	
213/16	UCFL215-213D1												UC215-213D1	
27/8	UCFL215-214D1												UC215-214D1	
215/16	UCFL215-215D1												UC215-215D1	
3	UCFL215-300D1												UC215-300D1	
80	UCFL216D1	290	233	34	22	58	25	180	83.3	82.6	33.3	M22	UC216D1	
31/16	UCFL216-301D1												UC216-301D1	
31/8	UCFL216-302D1												UC216-302D1	
33/16	UCFL216-303D1												UC216-303D1	
85	UCFL217D1	305	248	36	24	63	25	190	87.6	85.7	34.1	M22	UC217D1	
31/4	UCFL217-304D1												UC217-304D1	
35/16	UCFL217-305D1												UC217-305D1	
37/16	UCFL217-307D1												UC217-307D1	
90	UCFL218D1	320	265	40	24	68	25	205	96.3	96	39.7	M22	UC218D1	
31/2	UCFL218-308D1												UC218-308D1	

Note (1) These numbers indicate relubricatable type. If maintenance free type is needed, please order without suffix "D1".

Housing number	Unit number ⁽¹⁾ pressed steel dust cover type	Unit number ⁽¹⁾ cast dust cover type	Nominal dimensions					Mass of unit			
			t	A ₄	A ₅	L ₁	L ₂	kg lb			
			max.						UCFL	Z(ZM)	C(CM)
FL215D1	—	C(CM)-UCFL215D1	4	—	102	169	82	6.0	—	7.1	
FL215D1	—	C(CM)-UCFL215-213D1									
FL215D1	—	C(CM)-UCFL215-214D1									
FL215D1	—	C(CM)-UCFL215-215D1	5/32	—	41/32	621/32	37/32	13	—	16	
FL215D1	—	C(CM)-UCFL215-300D1									
FL216D1	—	C(CM)-UCFL216D1	4	—	106	183	90	7.4	—	8.6	
FL216D1	—	C(CM)-UCFL216-301D1									
FL216D1	—	C(CM)-UCFL216-302D1	5/32	—	43/16	77/32	317/32	16	—	19	
FL216D1	—	C(CM)-UCFL216-303D1									
FL217D1	—	C(CM)-UCFL217D1	5	—	114	192	95	8.8	—	10	
FL217D1	—	C(CM)-UCFL217-304D1									
FL217D1	—	C(CM)-UCFL217-305D1	13/64	—	41/2	79/16	33/4	19	—	22	
FL217D1	—	C(CM)-UCFL217-307D1									
FL218D1	—	C(CM)-UCFL218D1	5	—	122	205	102	11	—	13	
FL218D1	—	C(CM)-UCFL218-308D1	13/64	—	413/16	81/16	41/32	24	—	29	

PLUMMER BLOCKS

STANDARD TYPE PLUMMER BLOCKS.....	B306
LARGE PLUMMER BLOCKS.....	B312
DUSTPROOF PLUMMER BLOCKS.....	B316
STEPPED-SHAFT TYPE PLUMMER BLOCKS.....	B318

DESIGN, TYPES AND FEATURES

There are numerous types and sizes of plummer blocks. In this catalog, only the types marked by ■ are shown.



■ SN 5
■ SN 6
■ SN 30
■ SN 31
■ SN 2
■ SN 3
■ SN 2C
■ SN 3C

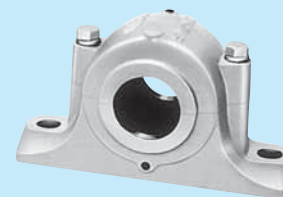

These are the most common type. Models SN30 and SN31 are for medium loads.

For types SN2C and SN3C, the bore diameters on the two sides are different.

■ SN 5B
■ SN 6B
■ SN 30B
■ SN 31B
■ SN 2B
■ SN 3B
■ SN 2BC
■ SN 3BC

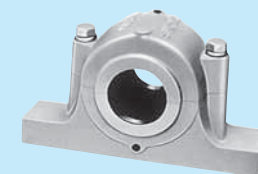

These have the same dimensions as those of types SN5 and SN6. To increase the bearing box strength, no material is removed from the top or bottom of the base, so mounting holes can be drilled anywhere.

■ SG 5



Dustproof plummer blocks have a combination of oil seals, labyrinth seals, and oil groove seals, therefore, they are suitable for environments with much dust and other foreign matter.

■ SD 30S
■ SD 31S
■ SD 5
■ SD 6
■ SD 2
■ SD 3
■ SD 2C
■ SD 3C

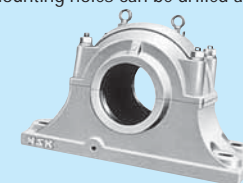

These are large and made for heavy loads. The standard ones have double seals and four mounting bolt holes. For types SD2C and SD3C, the bore diameters on the two sides are different.

■ SD31TS
■ SD32TS

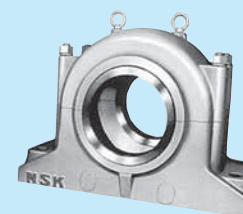

These are provided with labyrinth seals, so they are suitable for high speed applications.

■ V · C



Single-piece plummer blocks (integrated type roller bearing unit) have higher rigidity and precision than split type plummer blocks.

SN 5, SN 6 Types
Shaft Diameter 20 – 55 mm

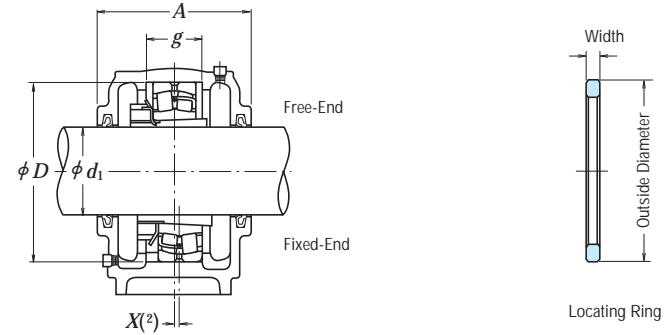
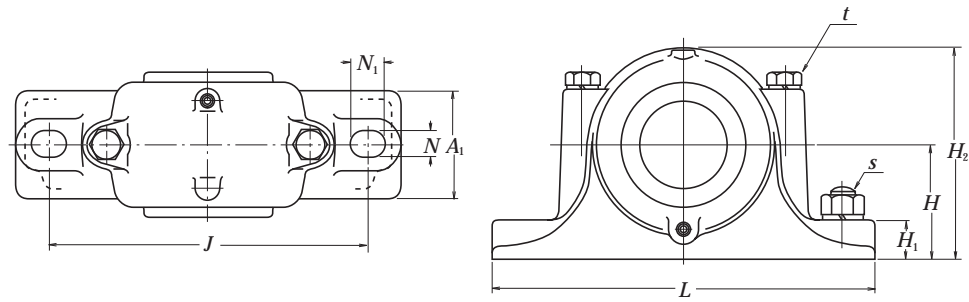

Shaft Diameter (mm) d_1	Plummer Block Bearing Box Numbers (1)	Dimensions (mm)											Mass (kg) approx.		
		D_{H8}	H_{h13}	J	N	N_1	A	L	A_1	H_1	H_2	g_{H13}		t nominal	s nominal
20	SN 505	52	40	130	15	20	67	165	46	22	75	25	M 8	M 12	1.1
	SN 605	62	50	150	15	20	80	185	52	22	90	34	M 8	M 12	1.6
25	SN 506	62	50	150	15	20	77	185	52	22	90	30	M 8	M 12	1.7
	SN 606	72	50	150	15	20	82	185	52	22	95	37	M 10	M 12	1.8
30	SN 507	72	50	150	15	20	82	185	52	22	95	33	M 10	M 12	1.9
	SN 607	80	60	170	15	20	90	205	60	25	110	41	M 10	M 12	2.6
35	SN 508	80	60	170	15	20	85	205	60	25	110	33	M 10	M 12	2.6
	SN 608	90	60	170	15	20	95	205	60	25	115	43	M 10	M 12	2.9
40	SN 509	85	60	170	15	20	85	205	60	25	112	31	M 10	M 12	2.8
	SN 609	100	70	210	18	23	105	255	70	28	130	46	M 12	M 16	4.1
45	SN 510	90	60	170	15	20	90	205	60	25	115	33	M 10	M 12	3.0
	SN 610	110	70	210	18	23	115	255	70	30	135	50	M 12	M 16	4.7
50	SN 511	100	70	210	18	23	95	255	70	28	130	33	M 12	M 16	4.5
	SN 611	120	80	230	18	23	120	275	80	30	150	53	M 12	M 16	5.8
55	SN 512	110	70	210	18	23	105	255	70	30	135	38	M 12	M 16	5.0
	SN 612	130	80	230	18	23	125	280	80	30	155	56	M 12	M 16	6.5

Note (1) Including oil seal.

To place an order for a complete unit, please specify, "Plummer block bearing box+bearing+adapter+locating ring".

Remarks Threads for plugs are R 1/8.

Applicable Parts								Oil Seals (3)
Self-Aligning Ball Bearing Numbers	Basic Dynamic Load Ratings C_r (N)	Spherical Roller Bearing Numbers	Basic Dynamic Load Ratings C_r (N)	Adapter Numbers	Nominal (Outside Dia. x Width)	Locating Rings (Outside Dia. x Width)	Q'ty	
1205 K	12 200	—	—	H 205X	SR 52x 5	2	GS 5	
2205 K	12 400	22205 CKE4	37 500	H 305X	SR 52x 7	1		
1305 K	18 200	21305 CDKE4	43 000	H 305X	SR 62x 8.5	2	GS 5	
2305 K	24 900	—	—	H 2305X	SR 62x 10	1		
1206 K	15 800	—	—	H 206X	SR 62x 7	2	GS 6	
2206 K	15 300	22206 CKE4	50 000	H 306X	SR 62x 10	1		
1306 K	21 400	21306 CDKE4	55 000	H 306X	SR 72x 9	2	GS 6	
2306 K	32 000	—	—	H 2306X	SR 72x 10	1		
1207 K	15 900	—	—	H 207X	SR 72x 8	2	GS 7	
2207 K	21 700	22207 CKE4	69 000	H 307X	SR 72x 10	1		
1307 K	25 300	21307 CDKE4	71 500	H 307X	SR 80x 10	2	GS 7	
2307 K	40 000	—	—	H 2307X	SR 80x 10	1		
1208 K	19 300	—	—	H 208X	SR 80x 7.5	2	GS 8	
2208 K	22 400	22208 EAKE4	90 500	H 308X	SR 80x 10	1		
1308 K	29 800	21308 EAKE4	94 500	H 308X	SR 90x 10	2	GS 8	
2308 K	45 500	22308 EAKE4	136 000	H 2308X	SR 90x 10	1		
1209 K	22 000	—	—	H 209X	SR 85x 6	2	GS 9	
2209 K	23 300	22209 EAKE4	94 500	H 309X	SR 85x 8	1		
1309 K	38 500	21309 EAKE4	119 000	H 309X	SR 100x 10.5	2	GS 9	
2309 K	55 000	22309 EAKE4	166 000	H 2309X	SR 100x 10	1		
1210 K	22 800	—	—	H 210X	SR 90x 6.5	2	GS10	
2210 K	23 400	22210 EAKE4	99 000	H 310X	SR 90x 10	1		
1310 K	43 500	21310 EAKE4	142 000	H 310X	SR 110x 11.5	2	GS10	
2310 K	65 000	22310 EAKE4	197 000	H 2310X	SR 110x 10	1		
1211 K	26 900	—	—	H 211X	SR 100x 6	2	GS11	
2211 K	26 700	22211 EAKE4	119 000	H 311X	SR 100x 8	1		
1311 K	51 500	21311 EAKE4	142 000	H 311X	SR 120x 12	2	GS11	
2311 K	76 500	22311 EAKE4	234 000	H 2311X	SR 120x 10	1		
1212 K	30 500	—	—	H 212X	SR 110x 8	2	GS12	
2212 K	34 000	22212 EAKE4	142 000	H 312X	SR 110x 10	1		
1312 K	57 500	21312 EAKE4	190 000	H 312X	SR 130x 12.5	2	GS12	
2312 K	88 500	22312 EAKE4	271 000	H 2312X	SR 130x 10	1		

Notes (2) The X dimension indicates the offset of the bearing center from the center of the plummer block bearing box. When one locating ring is used, it is 1/2 of the locating ring width, and when two rings are used, it becomes 0.

(3) Applicable to the ZF Type with the same number.

SN 31, SN 5, SN 6 Types
Shaft Diameter 60 – 100 mm

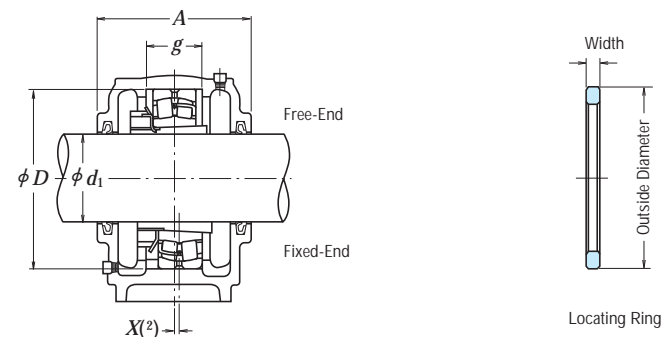
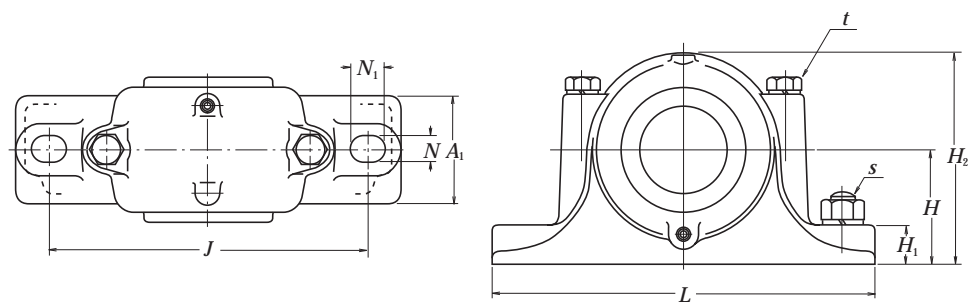

Shaft Diameter (mm) d_1	Plummer Block Bearing Box Numbers ⁽¹⁾	Dimensions (mm)											Mass (kg) approx.		
		D_{H8}	H_{h13}	J	N	N_1	A	L	A_1	H_1	H_2	g_{H13}		t nominal	s nominal
60	SN 513	120	80	230	18	23	110	275	80	30	150	43	M12	M16	5.6
	SN 613	140	95	260	22	27	130	315	90	32	175	58	M16	M20	8.7
65	SN 515	130	80	230	18	23	115	280	80	30	155	41	M12	M16	7.0
	SN 615	160	100	290	22	27	140	345	100	35	195	65	M16	M20	11.3
70	SN 516	140	95	260	22	27	120	315	90	32	175	43	M16	M20	9.0
	SN 616	170	112	290	22	27	145	345	100	35	212	68	M16	M20	12.6
75	SN 517	150	95	260	22	27	125	320	90	32	185	46	M16	M20	10
	SN 617	180	112	320	26	32	155	380	110	40	218	70	M20	M24	15
80	SN 518	160	100	290	22	27	145	345	100	35	195	62.4	M16	M20	13
	SN 618	190	112	320	26	32	160	380	110	40	225	74	M20	M24	19
85	SN 519	170	112	290	22	27	140	345	100	35	210	53	M16	M20	15
	SN 619	200	125	350	26	32	170	410	120	45	245	77	M20	M24	22
90	SN 520	180	112	320	26	32	160	380	110	40	218	70.3	M20	M24	18.5
	SN 620	215	140	350	26	32	175	410	120	45	270	83	M20	M24	25
100	SN 3122	180	112	320	26	32	155	380	110	40	218	66	M20	M24	18
	SN 522	200	125	350	26	32	175	410	120	45	240	80	M20	M24	20
	SN 622	240	150	390	28	36	190	450	130	50	300	90	M24	M24	32

Note ⁽¹⁾ Including oil seal.

To place an order for a complete unit, please specify, "Plummer block bearing box+bearing+adapter+locating ring".

- Remarks
- The threads for plugs are R 1/8 for SN 616 and SN 519 or under and R 1/4 for SN 617, SN 520, SN 3122, and over.
 - SN 620 and SN 622 are provided with eye bolts.

Applicable Parts							Oil Seals ⁽³⁾
Self-Aligning Ball Bearing Numbers	Basic Dynamic Load Ratings C_r (N)	Spherical Roller Bearing Numbers	Basic Dynamic Load Ratings C_r (N)	Adapter Numbers	Locating Rings Nominal (Outside Dia. x Width)	Q'ty	
1213 K	31 000	—	—	H 213X	SR 120x10	2	GS13
2213 K	43 500	22213 EAKE4	177 000	H 313X	SR 120x12	1	
1313 K	62 500	21313 EAKE4	212 000	H 313X	SR 140x12.5	2	GS13
2313 K	97 000	22313 EAKE4	300 000	H 2313X	SR 140x10	1	
1215 K	39 000	—	—	H 215X	SR 130x 8	2	GS15
2215 K	44 500	22215 EAKE4	190 000	H 315X	SR 130x10	1	
1315 K	80 000	21315 EAKE4	250 000	H 315X	SR 160x14	2	GS15
2315 K	125 000	22315 EAKE4	390 000	H 2315X	SR 160x10	1	
1216 K	40 000	—	—	H 216X	SR 140x 8.5	2	GS16
2216 K	49 000	22216 EAKE4	212 000	H 316X	SR 140x10	1	
1316 K	89 000	21316 EAKE4	284 000	H 316X	SR 170x14.5	2	GS16
2316 K	130 000	22316 EAKE4	435 000	H 2316X	SR 170x10	1	
1217 K	49 500	—	—	H 217X	SR 150x 9	2	GS17
2217 K	58 500	22217 EAKE4	250 000	H 317X	SR 150x10	1	
1317 K	98 500	21317 EAKE4	289 000	H 317X	SR 180x14.5	2	GS17
2317 K	142 000	22317 EAKE4	480 000	H 2317X	SR 180x10	1	
1218 K	57 500	—	—	H 218X	SR 160x16.2	2	GS18
2218 K	70 500	22218 EAKE4	289 000	H 318X	SR 160x11.2	2	
—	—	23218 CKE4	340 000	H 2318X	SR 160x10	1	GS18
1318 K	117 000	21318 EAKE4	330 000	H 318X	SR 190x15.5	2	
2318 K	154 000	22318 EAKE4	535 000	H 2318X	SR 190x10	1	
1219 K	64 000	—	—	H 219X	SR 170x10.5	2	GS19
2219 K	84 000	22219 EAKE4	330 000	H 319X	SR 170x10	1	
1319 K	129 000	21319 CKE4	345 000	H 319X	SR 200x16	2	GS19
2319 K	161 000	22319 EAKE4	590 000	H 2319X	SR 200x10	1	
1220 K	69 500	—	—	H 220X	SR 180x18.1	2	GS20
2220 K	94 500	22220 EAKE4	365 000	H 320X	SR 180x12.1	2	
—	—	23220 CKE4	420 000	H 2320X	SR 180x10	1	GS20
1320 K	140 000	21320 CKE4	395 000	H 320X	SR 215x18	2	
2320 K	187 000	22320 EAKE4	690 000	H 2320X	SR 215x10	1	
—	—	23122 CKE4	385 000	H 3122X	SR 180x10	1	GS22
1222 K	87 000	—	—	H 222X	SR 200x21	2	
2222 K	122 000	22222 EAKE4	485 000	H 322X	SR 200x13.5	2	
—	—	23222 CKE4	515 000	H 2322X	SR 200x10	1	GS22
1322 K	161 000	21322 CAKE4	450 000	H 322X	SR 240x20	2	
2322 K	211 000	22322 EAKE4	825 000	H 2322X	SR 240x10	1	

Notes ⁽²⁾ The X dimension indicates the offset of the bearing center from the center of the plummer block bearing box. When one locating ring is used, it is 1/2 of the locating ring width, and when two rings are used, it becomes 0.

⁽³⁾ Applicable to the ZF Type with the same number.

SN 30, SN 31, SN 5, SN 6 Types
Shaft Diameter 110 – 140 mm

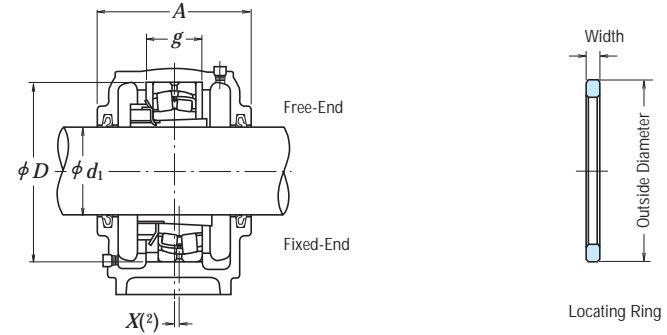
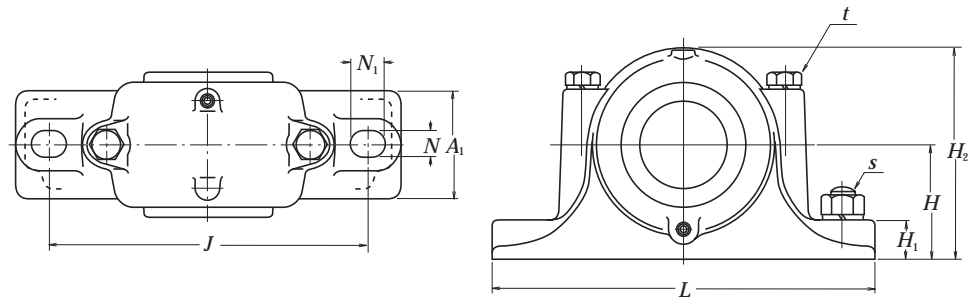

Shaft Diameter (mm) d_1	Plummer Block Bearing Box Numbers (1)	Dimensions (mm)											Mass (kg) approx.		
		D H8	H h13	J	N	N ₁	A	L	A ₁	H ₁	H ₂	g H13		t nominal	s nominal
110	SN 3024	180	112	320	26	32	150	380	110	40	218	56	M20	M24	16
	SN 3124	200	125	350	26	32	165	410	120	45	245	72	M20	M24	20
	SN 524	215	140	350	26	32	185	410	120	45	270	86	M20	M24	24.5
	SN 624	260	160	450	33	42	200	530	160	60	320	96	M24	M30	48
115	SN 3026	200	125	350	26	32	160	410	120	45	240	62	M20	M24	19
	SN 3126	210	140	350	26	32	170	410	120	45	270	74	M20	M24	26
	SN 526	230	150	380	28	36	190	445	130	50	290	90	M24	M24	30
	SN 626	280	170	470	33	42	210	550	160	60	340	103	M24	M30	56
125	SN 3028	210	140	350	26	32	170	410	120	45	270	63	M20	M24	25
	SN 3128	225	150	380	28	36	180	445	130	50	290	78	M24	M24	32
	SN 528	250	150	420	33	42	205	500	150	50	305	98	M24	M30	38
	SN 628	300	180	520	35	45	235	610	170	65	365	112	M30	M30	72
	SN 3030	225	150	380	28	36	175	445	130	50	290	66	M24	M24	29
135	SN 3130	250	150	420	33	42	200	500	150	50	305	90	M24	M30	38
	SN 530	270	160	450	33	42	220	530	160	60	325	106	M24	M30	46
	SN 630	320	190	560	35	45	245	650	180	65	385	118	M30	M30	98
	SN 3032	240	150	390	28	36	190	450	130	50	300	70	M24	M24	32
140	SN 3132	270	160	450	33	42	215	530	160	60	325	96	M24	M30	48
	SN 532	290	170	470	33	42	235	550	160	60	345	114	M24	M30	50
	SN 632	340	200	580	42	50	255	680	190	70	405	124	M30	M36	115

Self-Aligning Ball Bearing		Spherical Roller Bearing		Adapter Numbers	Locating Rings		Oil Seals (3)
Numbers	Basic Dynamic Load Ratings C _r (N)	Numbers	Basic Dynamic Load Ratings C _r (N)		Nominal (Outside Dia. x Width)	Q'ty	
—	—	23024 CDKE4	315 000	H 3024	SR 180×10	1	GS24
—	—	23124 CKE4	465 000	H 3124	SR 200×10	1	GS24
—	—	22224 EAKE4	550 000	H 3124	SR 215×14	2	GS24
—	—	23224 CKE4	630 000	H 2324	SR 215×10	1	GS24
—	—	22324 EAKE4	955 000	H 2324	SR 260×10	1	GS24
—	—	23026 CDKE4	400 000	H 3026	SR 200×10	1	GS26
—	—	23126 CKE4	505 000	H 3126	SR 210×10	1	GS26
—	—	22226 EAKE4	655 000	H 3126	SR 230×13	2	GS26
—	—	23226 CKE4	700 000	H 2326	SR 230×10	1	GS26
—	—	22326 EAKE4	995 000	H 2326	SR 280×10	1	GS26
—	—	23028 CDKE4	420 000	H 3028	SR 210×10	1	GS28
—	—	23128 CKE4	580 000	H 3128	SR 225×10	1	GS28
—	—	22228 CDKE4	645 000	H 3128	SR 250×15	2	GS28
—	—	23228 CKE4	835 000	H 2328	SR 250×10	1	GS28
—	—	22328 EAKE4	1 160 000	H 2328	SR 300×10	1	GS28
—	—	23030 CDKE4	470 000	H 3030	SR 225×10	1	GS30
—	—	23130 CKE4	725 000	H 3130	SR 250×10	1	GS30
—	—	22230 CDKE4	765 000	H 3130	SR 270×16.5	2	GS30
—	—	23230 CKE4	975 000	H 2330	SR 270×10	1	GS30
—	—	22330 EAKE4	1 220 000	H 2330	SR 320×10	1	GS30
—	—	23032 CDKE4	540 000	H 3032	SR 240×10	1	GS32
—	—	23132 CKE4	855 000	H 3132	SR 270×10	1	GS32
—	—	22232 CDKE4	910 000	H 3132	SR 290×17	2	GS32
—	—	23232 CKE4	1 100 000	H 2332	SR 290×10	1	GS32
—	—	22332 EAKE4	1 360 000	H 2332	SR 340×10	1	GS32

Note (1) Including oil seal.
To place an order for a complete unit, please specify, "Plummer block bearing box+bearing+adapter+locating ring".
Remarks 1. The threads for plugs are R 1/4.
2. The bearing boxes for SN 524, SN 624, SN 3126, SN 3028, and over are provided with eye bolts.

Notes (2) The X dimension indicates the offset of the bearing center from the center of the plummer block bearing box. When one locating ring is used, it is 1/2 of the locating ring width, and when two rings are used, it becomes 0.
(3) Applicable to the ZF Type with the same number.

SD 30 S, SD 31 S, SD 5, SD 6 Types
Shaft Diameter 150 – 260 mm

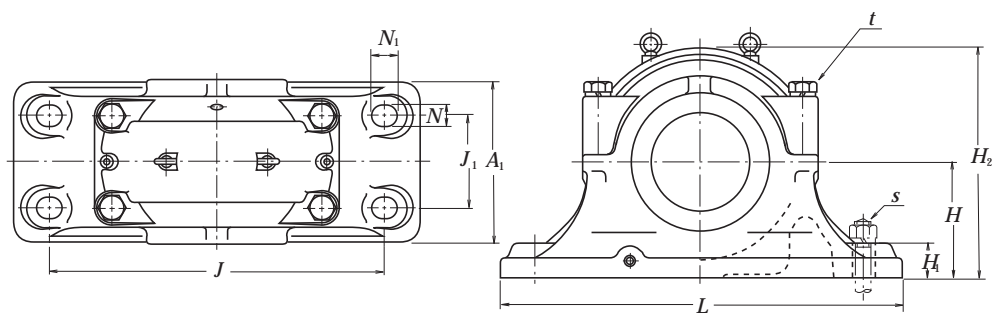

Shaft Diameter (mm) d_1	Plummer Block Bearing Box Numbers ⁽¹⁾		Dimensions (mm)										
	Free-End	Fixed-End	D_{H8}	H_{h13}	J	N	N_1	A	L	A_1	H_1	H_2	J_1
150	SD 3034 S	SD 3034 SG	260	160	450	36	46	230	540	200	50	315	110
	SD 3134 S	SD 3134 SG	280	170	470	36	46	250	560	220	50	335	120
	SD 534	SD 534 G	310	180	510	36	46	270	620	250	60	360	140
	SD 634	SD 634 G	360	210	610	36	46	300	740	290	65	420	170
160	SD 3036 S	SD 3036 SG	280	170	470	36	46	250	560	220	50	335	120
	SD 3136 S	SD 3136 SG	300	180	520	36	46	270	630	250	55	355	140
	SD 536	SD 536 G	320	190	540	36	46	280	650	260	60	380	150
	SD 636	SD 636 G	380	225	640	43	59	320	780	310	70	450	180
170	SD 3038 S	SD 3038 SG	290	170	470	36	46	250	560	220	50	340	120
	SD 3138 S	SD 3138 SG	320	190	560	36	46	290	680	270	55	385	140
	SD 538	SD 538 G	340	200	570	36	46	290	700	280	65	400	160
	SD 638	SD 638 G	400	240	680	43	59	330	820	320	70	475	190
180	SD 3040 S	SD 3040 SG	310	180	510	36	46	270	620	250	60	360	140
	SD 3140 S	SD 3140 SG	340	200	570	36	46	310	700	280	65	400	160
	SD 540	SD 540 G	360	210	610	36	46	300	740	290	65	420	170
	SD 640	SD 640 G	420	250	710	43	59	350	860	340	85	500	200
200	SD 3044 S	SD 3044 SG	340	200	570	36	46	290	700	280	65	400	160
	SD 3144 S	SD 3144 SG	370	225	640	43	59	320	780	310	70	445	180
	SD 544	SD 544 G	400	240	680	43	59	330	820	320	70	475	190
	SD 644	SD 644 G	460	280	770	43	59	360	920	350	85	550	210
220	SD 3048 S	SD 3048 SG	360	210	610	36	46	300	740	290	65	420	170
	SD 3148 S	SD 3148 SG	400	240	680	43	59	330	820	320	70	475	190
	SD 548	SD 548 G	440	260	740	43	59	340	880	330	85	515	200
	SD 648	SD 648 G	500	300	830	50	67	390	990	380	100	590	230
240	SD 3052 S	SD 3052 SG	400	240	680	43	59	340	820	320	70	475	190
	SD 3152 S	SD 3152 SG	440	260	740	43	59	360	880	350	85	515	200
	SD 552	SD 552 G	480	280	790	43	59	370	940	360	85	560	210
	SD 652	SD 652 G	540	325	890	50	67	410	1 060	400	100	640	250
260	SD 3056 S	SD 3056 SG	420	250	710	43	59	350	860	340	85	500	200
	SD 3156 S	SD 3156 SG	460	280	770	43	59	360	920	350	85	550	210
	SD 556	SD 556 G	500	300	830	50	67	390	990	380	100	590	230
	SD 656	SD 656 G	580	355	930	57	77	440	1 110	430	110	690	270

Note ⁽¹⁾ Including oil seal.

To place an order for a complete unit, please specify, "Plummer block bearing box+bearing+adapter".

- Remarks
- The threads for oil replenishing hole plugs are R 1/4 and those for drain plugs are R 3/8.
 - The plummer block bearing boxes listed above are provided with eye bolts.

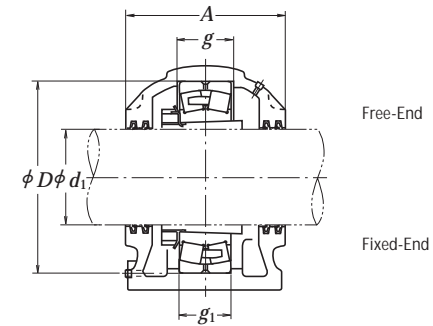

g_{H13}	g_{1H13}	$t_{nominal}$	$s_{nominal}$	Mass (kg) approx.	Applicable Parts		Oil Seals ⁽²⁾	
					Spherical Roller Bearing Numbers	Adapter Numbers		
77	67	M 24	M 30	70	23034 CDKE4	640 000	H 3034	GS 34
98	88	M 24	M 30	75	23134 CKE4	940 000	H 3134	GS 34
96	86	M 24	M 30	100	22234 CDKE4	990 000	H 3134	GS 34
130	120	M 30	M 30	160	22334 CAKE4	1 580 000	H 2334	GS 34
84	74	M 24	M 30	79	23036 CDKE4	750 000	H 3036	GS 36
106	96	M 24	M 30	94	23136 CKE4	1 050 000	H 3136	GS 36
96	86	M 24	M 30	110	22236 CDKE4	1 020 000	H 3136	GS 36
136	126	M 30	M 36	195	22336 CAKE4	1 740 000	H 2336	GS 36
85	75	M 24	M 30	87	23038 CAKE4	775 000	H 3038	GS 38
114	104	M 24	M 30	110	23138 CKE4	1 190 000	H 3138	GS 38
102	92	M 30	M 30	130	22238 CAKE4	1 140 000	H 3138	GS 38
142	132	M 30	M 36	210	22338 CAKE4	1 890 000	H 2338	GS 38
92	82	M 24	M 30	100	23040 CAKE4	940 000	H 3040	GS 40
122	112	M 30	M 30	130	23140 CKE4	1 360 000	H 3140	GS 40
108	98	M 30	M 30	155	22240 CAKE4	1 300 000	H 3140	GS 40
148	138	M 36	M 36	240	22340 CAKE4	2 000 000	H 2340	GS 40
100	90	M 30	M 30	130	23044 CAKE4	1 090 000	H 3044	GS 44
130	120	M 30	M 36	180	23144 CKE4	1 570 000	H 3144	GS 44
118	108	M 30	M 36	205	22244 CAKE4	1 570 000	H 3144	GS 44
155	145	M 36	M 36	315	22344 CAKE4	2 350 000	H 2344	GS 44
102	92	M 30	M 30	160	23048 CAKE4	1 160 000	H 3048	GS 48
138	128	M 30	M 36	210	23148 CKE4	1 790 000	H 3148	GS 48
130	120	M 36	M 36	240	22248 CAKE4	1 870 000	H 3148	GS 48
165	155	M 36	M 42	405	22348 CAKE4	2 600 000	H 2348	GS 48
114	104	M 30	M 36	210	23052 CAKE4	1 430 000	H 3052	GS 52
154	144	M 36	M 36	240	23152 CAKE4	2 160 000	H 3152	GS 52
140	130	M 36	M 36	315	22252 CAKE4	2 180 000	H 3152	GS 52
175	165	M 36	M 42	480	22352 CAKE4	3 100 000	H 2352	GS 52
116	106	M 36	M 36	240	23056 CAKE4	1 540 000	H 3056	GS 56
156	146	M 36	M 36	315	23156 CAKE4	2 230 000	H 3156	GS 56
140	130	M 36	M 42	390	22256 CAKE4	2 280 000	H 3156	GS 56
185	175	M 42	M 48	610	22356 CAKE4	3 500 000	H 2356	GS 56

Note ⁽²⁾ Applicable to the ZF Type with the same number.

LARGE-SIZE PLUMMER BLOCKS

SD 30 S, SD 31 S, SD 5 Types
Shaft Diameter 280 – 450 mm

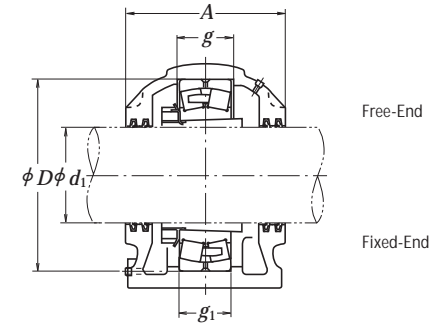
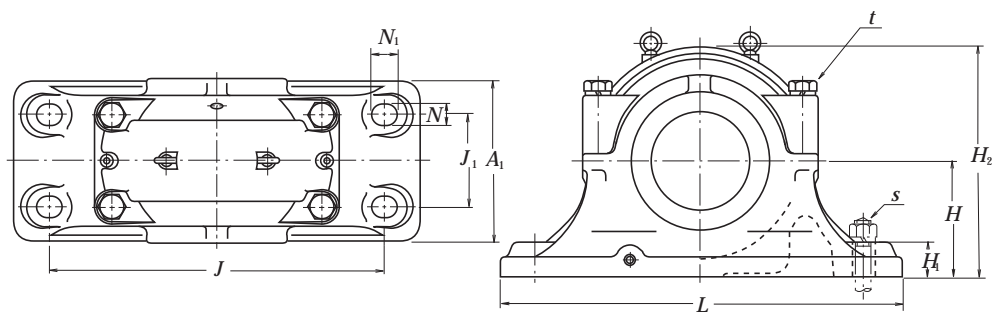

Shaft Diameter (mm) d_1	Plummer Block Bearing Box Numbers ⁽¹⁾		Dimensions (mm)										
	Free-End	Fixed-End	D_{H8}	H_{h13}	J	N	N_1	A	L	A_1	H_1	H_2	J_1
280	SD 3060 S	SD 3060 SG	460	280	770	43	59	360	920	350	85	550	210
	SD 3160 S	SD 3160 SG	500	300	830	50	67	390	990	380	100	590	230
	SD 560	SD 560 G	540	325	890	50	67	410	1 060	400	100	640	250
300	SD 3064 S	SD 3064 SG	480	280	790	43	59	380	940	360	85	560	210
	SD 3164 S	SD 3164 SG	540	325	890	50	67	430	1 060	400	100	640	250
	SD 564	SD 564 G	580	355	930	57	77	440	1 110	430	110	690	270
320	SD 3068 S	SD 3068 SG	520	310	860	50	67	400	1 020	370	100	615	230
	SD 3168 S	SD 3168 SG	580	355	930	57	77	470	1 110	450	110	690	270
340	SD 3072 S	SD 3072 SG	540	325	890	50	67	410	1 060	390	100	640	250
	SD 3172 S	SD 3172 SG	600	365	960	57	77	470	1 140	460	120	710	310
360	SD 3076 S	SD 3076 SG	560	340	900	50	67	410	1 080	390	100	665	260
	SD 3176 S	SD 3176 SG	620	375	980	57	77	500	1 160	490	120	735	320
380	SD 3080 S	SD 3080 SG	600	365	960	57	77	430	1 140	420	120	710	270
	SD 3180 S	SD 3180 SG	650	390	1 040	57	77	520	1 220	510	125	765	340
400	SD 3084 S	SD 3084 SG	620	375	980	57	77	430	1 160	420	120	735	270
	SD 3184 S	SD 3184 SG	700	420	1 070	57	77	560	1 250	550	135	830	380
410	SD 3088 S	SD 3088 SG	650	390	1 040	57	77	460	1 220	450	125	765	280
430	SD 3092 S	SD 3092 SG	680	405	1 040	57	77	470	1 220	460	130	790	310
450	SD 3096 S	SD 3096 SG	700	415	1 100	57	77	485	1 280	470	130	820	320

g_{H13}	g_{13}	$t_{nominal}$	$s_{nominal}$	Mass (kg) approx.	Applicable Parts		Oil Seals ⁽²⁾
					Spherical Roller Bearing Numbers	Adapter Numbers	
128	118	M 36	M 36	300	23060 CAKE4	H 3060	GS 60
170	160	M 36	M 42	405	23160 CAKE4	H 3160	GS 60
150	140	M 36	M 42	465	22260 CAKE4	H 3160	GS 60
131	121	M 36	M 36	320	23064 CAKE4	H 3064	GS 64
186	176	M 36	M 42	480	23164 CAKE4	H 3164	GS 64
160	150	M 42	M 48	595	22264 CAKE4	H 3164	GS 64
143	133	M 36	M 42	410	23068 CAKE4	H 3068	GS 68
200	190	M 42	M 48	650	23168 CAKE4	H 3168	GS 68
144	134	M 36	M 42	465	23072 CAKE4	H 3072	GS 72
202	192	M 42	M 48	700	23172 CAKE4	H 3172	GS 72
145	135	M 36	M 42	480	23076 CAKE4	H 3076	GS 76
204	194	M 42	M 48	940	23176 CAKE4	H 3176	GS 76
158	148	M 42	M 48	690	23080 CAKE4	H 3080	GS 80
210	200	M 42	M 48	1 040	23180 CAKE4	H 3180	GS 80
160	150	M 42	M 48	770	23084 CAKE4	H 3084	GS 84
234	224	M 48	M 48	1 150	23184 CAKE4	H 3184	GS 84
167	157	M 42	M 48	870	23088 CAKE4	H 3088	GS 88
173	163	M 48	M 48	940	23092 CAKE4	H 3092	GS 92
175	165	M 48	M 48	1 040	23096 CAKE4	H 3096	GS 96

Note ⁽¹⁾ Including oil seal.

To place an order for a complete unit, please specify, "Plummer block bearing box+bearing+adapter".

Remarks 1. The threads for oil replenishing hole plugs are R 1/4 and those for drain plugs are R 3/8.

2. The plummer block bearing boxes listed above are provided with eye bolts.

Note ⁽²⁾ Applicable to the ZF Type with the same number.

SG 5, SG 5-0 Types
Shaft Diameter 50 – 180 mm

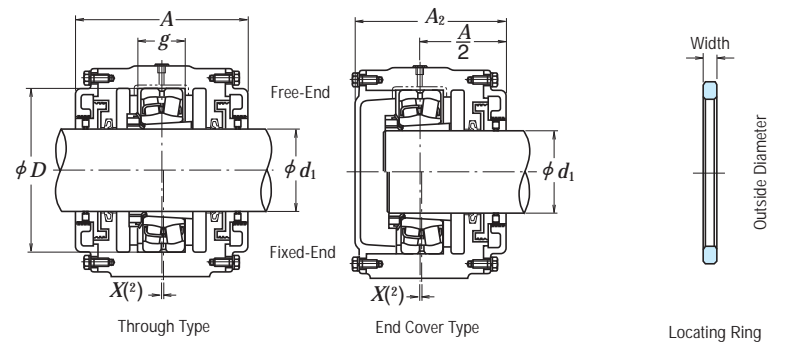
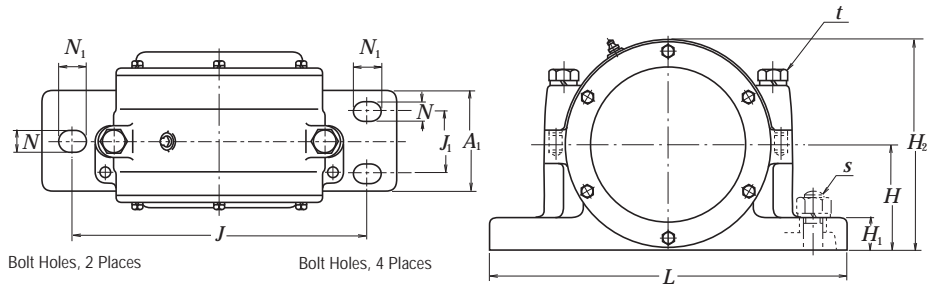

Shaft Diameter (mm) d_1	Plummer Block Bearing Box Numbers (1)		Dimensions (mm)												
	Through Type	End Cover Type	D	H	J	N	N_1	A	L	A_1	H_1	H_2	J_1	A_2	g
			H8	h13											
50	SG 511	SG 511-0	100	70	210	18	23	125	255	70	23	137	—	112.5	29
55	SG 512	SG 512-0	110	80	230	18	23	145	290	80	25	160	—	135	32
60	SG 513	SG 513-0	120	83	230	18	23	130	290	70	25	155	—	115	36
65	SG 515	SG 515-0	130	90	230	18	23	135	290	80	25	168	—	120	36
70	SG 516	SG 516-0	140	95	270	22	27	165	340	120	30	180	70	155	38
75	SG 517	SG 517-0	150	100	280	22	27	170	350	120	30	190	70	160	41
80	SG 518	SG 518-0	160	100	290	22	27	180	360	120	35	200	70	170	45
90	SG 520	SG 520-0	180	125	340	22	27	200	410	130	35	240	70	185	51
100	SG 522	SG 522-0	200	140	380	22	27	210	460	130	40	265	70	190	58
110	SG 524	SG 524-0	215	140	380	22	27	230	460	130	45	275	80	200	63
115	SG 526	SG 526-0	230	150	410	26	32	240	490	160	45	295	80	220	69
125	SG 528	SG 528-0	250	160	435	26	32	245	520	160	50	310	80	220	73
135	SG 530	SG 530-0	270	160	465	26	32	265	550	170	50	330	100	240	78
140	SG 532	SG 532-0	290	170	490	26	32	285	580	170	50	350	100	250	85
150	SG 534	SG 534-0	310	180	550	33	42	300	640	180	55	380	100	265	91
160	SG 536	SG 536-0	320	190	600	33	42	325	690	190	55	400	110	285	91
170	SG 538	SG 538-0	340	200	620	42	52	340	730	200	60	420	120	295	97
180	SG 540	SG 540-0	360	210	635	42	52	350	750	210	60	445	130	310	103

t nominal	s nominal	Mass (kg) approx.		Applicable Parts					Oil Seals (3)
		Through Type	End Cover Type	Spherical Roller Bearing		Adapter Numbers	Locating Ring		
				Numbers	Basic Dynamic Load Ratings C_r (N)		Nominal (Outside Dia.xWidth)	Q'ty	
M 12	M 16	8.5	7.5	22211 EAKE4	119 000	H 311 X	SR 100x4	1	GS 11
M 16	M 16	15	14	22212 EAKE4	142 000	H 312 X	SR 110x4	1	GS 12
M 16	M 16	9.5	8.5	22213 EAKE4	177 000	H 313 X	SR 120x5	1	GS 13
M 16	M 16	12.5	11	22215 EAKE4	190 000	H 315 X	SR 130x5	1	GS 15
M 20	M 20	18.5	17	22216 EAKE4	212 000	H 316 X	SR 140x5	1	GS 16
M 20	M 20	21	20	22217 EAKE4	250 000	H 317 X	SR 150x5	1	GS 17
M 20	M 20	25	23	22218 EAKE4	289 000	H 318 X	SR 160x5	1	GS 18
M 20	M 20	37	34	22220 EAKE4	365 000	H 320 X	SR 180x5	1	GS 20
M 20	M 20	50	45	22222 EAKE4	485 000	H 322 X	SR 200x5	1	GS 22
M 20	M 20	59	53	22224 EAKE4	550 000	H 3124	SR 215x5	1	GS 24
M 24	M 24	67	62	22226 EAKE4	655 000	H 3126	SR 230x5	1	GS 26
M 24	M 24	73	68	22228 CDKE4	645 000	H 3128	SR 250x5	1	GS 28
M 24	M 24	90	80	22230 CDKE4	765 000	H 3130	SR 270x5	1	GS 30
M 24	M 24	105	92	22232 CDKE4	910 000	H 3132	SR 290x5	1	GS 32
M 30	M 30	130	115	22234 CDKE4	990 000	H 3134	SR 310x5	1	GS 34
M 30	M 30	155	135	22236 CDKE4	1 020 000	H 3136	SR 320x5	1	GS 36
M 36	M 36	175	155	22238 CAKE4	1 140 000	H 3138	SR 340x5	1	GS 38
M 36	M 36	210	180	22240 CAKE4	1 300 000	H 3140	SR 360x5	1	GS 40

Note (1) Including oil seal.
To place an order for a complete unit, please specify, "Plummer block bearing box+bearing+adapter+locating ring".
Remarks 1. The threads for grease nipples are R 1/8 for SG518 and under, and R 1/4 for SG520 and over.
2. Bearing boxes larger than SG520 are provided with eye bolts.

Notes (2) The X dimension indicates the offset of the bearing center from the center of plummer block bearing box, and it is 1/2 of the locating ring width.
(3) Applicable to the ZF Type with the same number.

STEPPED-SHAFT TYPE PLUMMER BLOCKS

SN 2 C, SN 3 C Types
Shaft Diameter 25 – 55 mm

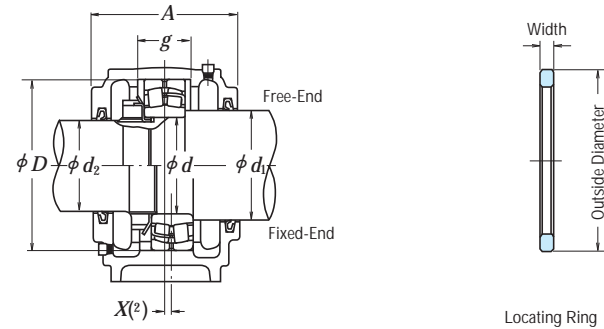
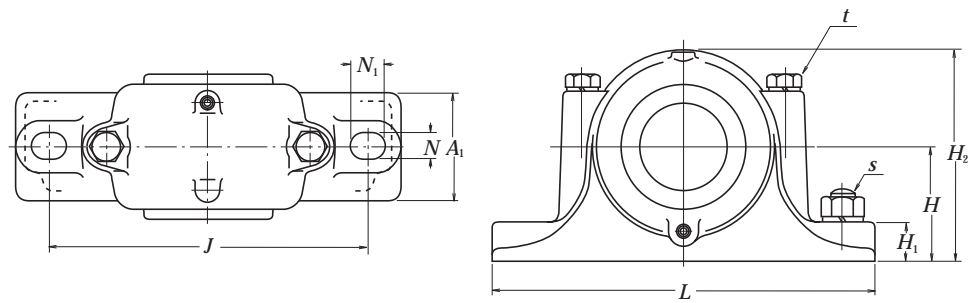

Shaft Diameter (mm) <i>d</i>	Plummer Block Bearing Box Numbers ⁽¹⁾	Dimensions (mm)														
		<i>d</i> ₁	<i>d</i> ₂	<i>D</i> _{H8}	<i>H</i> _{h13}	<i>J</i>	<i>N</i>	<i>N</i> ₁	<i>A</i>	<i>L</i>	<i>A</i> ₁	<i>H</i> ₁	<i>H</i> ₂	<i>g</i> _{H13}	<i>t</i> _{nominal}	<i>s</i> _{nominal}
25	SN 205 C	30	20	52	40	130	15	20	67	165	46	22	75	25	M 8	M 12
	SN 305 C	30	20	62	50	150	15	20	80	185	52	22	90	34	M 8	M 12
30	SN 206 C	35	25	62	50	150	15	20	77	185	52	22	90	30	M 8	M 12
	SN 306 C	35	25	72	50	150	15	20	82	185	52	22	95	37	M 10	M 12
35	SN 207 C	45	30	72	50	150	15	20	82	185	52	22	95	33	M 10	M 12
	SN 307 C	45	30	80	60	170	15	20	90	205	60	25	110	41	M 10	M 12
40	SN 208 C	50	35	80	60	170	15	20	85	205	60	25	110	33	M 10	M 12
	SN 308 C	50	35	90	60	170	15	20	95	205	60	25	115	43	M 10	M 12
45	SN 209 C	55	40	85	60	170	15	20	85	205	60	25	112	31	M 10	M 12
	SN 309 C	55	40	100	70	210	18	23	105	255	70	28	130	46	M 12	M 16
50	SN 210 C	60	45	90	60	170	15	20	90	205	60	25	115	33	M 10	M 12
	SN 310 C	60	45	110	70	210	18	23	115	255	70	30	135	50	M 12	M 16
55	SN 211 C	65	50	100	70	210	18	23	95	255	70	28	130	33	M 12	M 16
	SN 311 C	65	50	120	80	230	18	23	120	275	80	30	150	53	M 12	M 16

Note ⁽¹⁾ Including oil seal.

To place an order for a complete unit, please specify, "Plummer block bearing box+bearing+nut+Lock-washer+locating ring".

Remarks The threads for plugs are R 1/8.

Mass (kg) approx.	Applicable Parts							Oil Seals ⁽²⁾		
	Self-Aligning Ball Bearing Numbers	B. D. L. R. ⁽⁴⁾ C _r (N)	Spherical Roller Bearing Numbers	B. D. L. R. ⁽⁴⁾ C _r (N)	Nut Numbers	Lock-washer Numbers	Locating Ring Nominal (Outside Dia.×Width)	Q'ty	Side <i>d</i> ₁	Side <i>d</i> ₂
1.1	1205	12 200	—	—	AN 05	AW 05X	SR 52 × 5	2	GS 7	GS 5
	2205	12 400	22205 CE4	37 500	AN 05	AW 05X	SR 52 × 7	1		
1.6	1305	18 200	21305 CDE4	43 000	AN 05	AW 05X	SR 62 × 8.5	2	GS 7	GS 5
	2305	24 900	—	—	AN 05	AW 05X	SR 62 × 10	1		
1.7	1206	15 800	—	—	AN 06	AW 06X	SR 62 × 7	2	GS 8	GS 6
	2206	15 300	22206 CE4	50 000	AN 06	AW 06X	SR 62 × 10	1		
1.8	1306	21 400	21306 CDE4	55 000	AN 06	AW 06X	SR 72 × 9	2	GS 8	GS 6
	2306	32 000	—	—	AN 06	AW 06X	SR 72 × 10	1		
1.9	1207	15 900	—	—	AN 07	AW 07X	SR 72 × 8	2	GS 10	GS 7
	2207	21 700	22207 CE4	69 000	AN 07	AW 07X	SR 72 × 10	1		
2.6	1307	25 300	21307 CDE4	71 500	AN 07	AW 07X	SR 80 × 10	2	GS 10	GS 7
	2307	40 000	—	—	AN 07	AW 07X	SR 80 × 10	1		
2.6	1208	19 300	—	—	AN 08	AW 08X	SR 80 × 7.5	2	GS 11	GS 8
	2208	22 400	22208 EAE4	90 500	AN 08	AW 08X	SR 80 × 10	1		
2.9	1308	29 800	21308 EAE4	94 500	AN 08	AW 08X	SR 90 × 10	2	GS 11	GS 8
	2308	45 500	22308 EAE4	136 000	AN 08	AW 08X	SR 90 × 10	1		
2.8	1209	22 000	—	—	AN 09	AW 09X	SR 85 × 6	2	GS 12	GS 9
	2209	23 300	22209 EAE4	94 500	AN 09	AW 09X	SR 85 × 8	1		
4.1	1309	38 500	21309 EAE4	119 000	AN 09	AW 09X	SR 100 × 10.5	2	GS 12	GS 9
	2309	55 000	22309 EAE4	166 000	AN 09	AW 09X	SR 100 × 10	1		
3.0	1210	22 800	—	—	AN 10	AW 10X	SR 90 × 6.5	2	GS 13	GS 10
	2210	23 400	22210 EAE4	99 000	AN 10	AW 10X	SR 90 × 10	1		
4.7	1310	43 500	21310 EAE4	142 000	AN 10	AW 10X	SR 110 × 11.5	2	GS 13	GS 10
	2310	65 000	22310 EAE4	197 000	AN 10	AW 10X	SR 110 × 10	1		
4.5	1211	26 900	—	—	AN 11	AW 11X	SR 100 × 6	2	GS 15	GS 11
	2211	26 700	22211 EAE4	119 000	AN 11	AW 11X	SR 100 × 8	1		
5.8	1311	51 500	21311 EAE4	142 000	AN 11	AW 11X	SR 120 × 12	2	GS 15	GS 11
	2311	76 500	22311 EAE4	234 000	AN 11	AW 11X	SR 120 × 10	1		

Notes ⁽²⁾ The *X* dimension indicates the offset of the bearing center from the center of the plummer block bearing box. When one locating ring is used, it is 1/2 of the locating ring width, and when two rings are used, it becomes 0.

⁽³⁾ Applicable to the ZF Type with the same number. ⁽⁴⁾ B. D. L. R. : Basic Dynamic Load Ratings

STEPPED-SHAFT TYPE PLUMMER BLOCKS

SN 2 C, SN 3 C Types
Shaft Diameter 60 – 90 mm

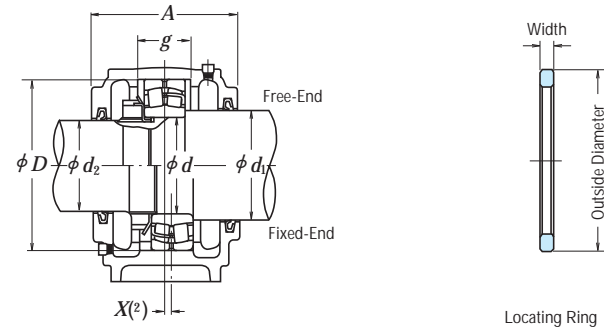
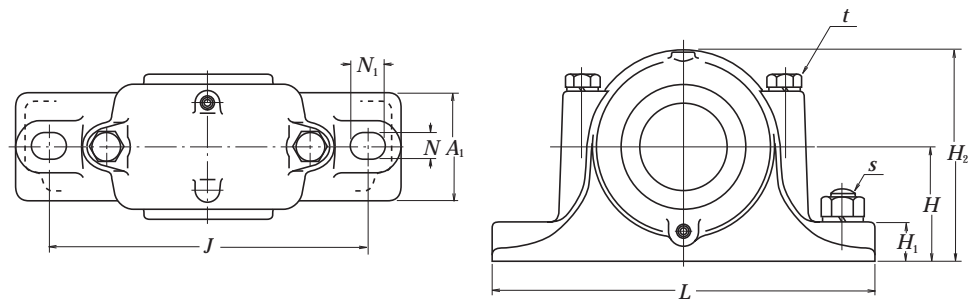

Shaft Diameter (mm) <i>d</i>	Plummer Block Bearing Box Numbers ⁽¹⁾	Dimensions (mm)														
		<i>d</i> ₁	<i>d</i> ₂	<i>D</i> _{H8}	<i>H</i> _{h13}	<i>J</i>	<i>N</i>	<i>N</i> ₁	<i>A</i>	<i>L</i>	<i>A</i> ₁	<i>H</i> ₁	<i>H</i> ₂	<i>g</i> _{H13}	<i>t</i> _{nominal}	<i>s</i> _{nominal}
60	SN 212 C	70	55	110	70	210	18	23	105	255	70	30	135	38	M 12	M 16
	SN 312 C	70	55	130	80	230	18	23	125	280	80	30	155	56	M 12	M 16
65	SN 213 C	75	60	120	80	230	18	23	110	275	80	30	150	43	M 12	M 16
	SN 313 C	75	60	140	95	260	22	27	130	315	90	32	175	58	M 16	M 20
70	SN 214 C	80	65	125	80	230	18	23	115	275	80	30	155	44	M 12	M 16
	SN 314 C	80	65	150	95	260	22	27	130	320	90	32	185	61	M 16	M 20
75	SN 215 C	85	70	130	80	230	18	23	115	280	80	30	155	41	M 12	M 16
	SN 315 C	85	70	160	100	290	22	27	140	345	100	35	195	65	M 16	M 20
80	SN 216 C	90	75	140	95	260	22	27	120	315	90	32	175	43	M 16	M 20
	SN 316 C	90	75	170	112	290	22	27	145	345	100	35	212	68	M 16	M 20
85	SN 217 C	95	80	150	95	260	22	27	125	320	90	32	185	46	M 16	M 20
	SN 317 C	95	80	180	112	320	26	32	155	380	110	40	218	70	M 20	M 24
90	SN 218 C	100	85	160	100	290	22	27	145	345	100	35	195	62.4	M 16	M 20
	SN 318 C	105	85	190	112	320	26	32	160	380	110	40	225	74	M 20	M 24

Note ⁽¹⁾ Including oil seal.

To place an order for a complete unit, please specify, "Plummer block bearing box+bearing+nut+Lock-washer+locating ring".

Remarks The threads for plugs are R 1/8 for SN316C, SN218C, and under and R 1/4 for SN317C and over.

Mass (kg) approx.	Applicable Parts								Oil Seals ⁽²⁾	
	Self-Aligning Ball Bearing Numbers	B. D. L. R. ⁽⁴⁾ C _r (N)	Spherical Roller Bearing Numbers	B. D. L. R. ⁽⁴⁾ C _r (N)	Nut Numbers	Lock-washer Numbers	Locating Ring Nominal (Outside Dia.×Width)	Q'ty	Side <i>d</i> ₁	Side <i>d</i> ₂
5.0	1212	30 500	—	—	AN 12	AW 12X	SR 110 × 8	2	GS 16	GS 12
	2212	34 000	22212 EAE4	142 000	AN 12	AW 12X	SR 110 × 10	1		
6.5	1312	57 500	21312 EAE4	190 000	AN 12	AW 12X	SR 130 × 12.5	2	GS 16	GS 12
	2312	88 500	22312 EAE4	271 000	AN 12	AW 12X	SR 130 × 10	1		
5.6	1213	31 000	—	—	AN 13	AW 13X	SR 120 × 10	2	GS 17	GS 13
	2213	43 500	22213 EAE4	177 000	AN 13	AW 13X	SR 120 × 12	1		
8.7	1313	62 500	21313 EAE4	212 000	AN 13	AW 13X	SR 140 × 12.5	2	GS 17	GS 13
	2313	97 000	22313 EAE4	300 000	AN 13	AW 13X	SR 140 × 10	1		
6.2	1214	35 000	—	—	AN 14	AW 14X	SR 125 × 10	2	GS 18	GS 15
	2214	44 000	22214 EAE4	180 000	AN 14	AW 14X	SR 125 × 13	1		
10	1314	65 000	21314 EAE4	250 000	AN 14	AW 14X	SR 150 × 13	2	GS 18	GS 15
	2314	111 000	22314 EAE4	340 000	AN 14	AW 14X	SR 150 × 10	1		
7.0	1215	39 000	—	—	AN 15	AW 15X	SR 130 × 8	2	GS 19	GS 16
	2215	44 500	22215 EAE4	190 000	AN 15	AW 15X	SR 130 × 10	1		
11.3	1315	80 000	21315 EAE4	250 000	AN 15	AW 15X	SR 160 × 14	2	GS 19	GS 16
	2315	125 000	22315 EAE4	390 000	AN 15	AW 15X	SR 160 × 10	1		
9.0	1216	40 000	—	—	AN 16	AW 16X	SR 140 × 8.5	2	GS 20	GS 17
	2216	49 000	22216 EAE4	212 000	AN 16	AW 16X	SR 140 × 10	1		
12.6	1316	89 000	21316 EAE4	284 000	AN 16	AW 16X	SR 170 × 14.5	2	GS 20	GS 17
	2316	130 000	22316 EAE4	435 000	AN 16	AW 16X	SR 170 × 10	1		
10	1217	49 500	—	—	AN 17	AW 17X	SR 150 × 9	2	GS 21	GS 18
	2217	58 500	22217 EAE4	250 000	AN 17	AW 17X	SR 150 × 10	1		
15	1317	98 500	21317 EAE4	289 000	AN 17	AW 17X	SR 180 × 14.5	2	GS 21	GS 18
	2317	142 000	22317 EAE4	480 000	AN 17	AW 17X	SR 180 × 10	1		
13	1218	57 500	—	—	AN 18	AW 18X	SR 160 × 16.2	2	GS 22	GS 19
	2218	70 500	22218 EAE4	289 000	AN 18	AW 18X	SR 160 × 11.2	2		
	—	—	23218 CE4	340 000	AN 18	AW 18X	SR 160 × 10	1		
19	1318	117 000	21318 EAE4	330 000	AN 18	AW 18X	SR 190 × 15.5	2	GS 23	GS 19
	2318	154 000	22318 EAE4	535 000	AN 18	AW 18X	SR 190 × 10	1		

Notes ⁽²⁾ The *X* dimension indicates the offset of the bearing center from the center of the plummer block bearing box. When one locating ring is used, it is 1/2 of the locating ring width, and when two rings are used, it becomes 0.

⁽³⁾ Applicable to the ZF Type with the same number. ⁽⁴⁾ B. D. L. R. : Basic Dynamic Load Ratings

STEPPED-SHAFT TYPE PLUMMER BLOCKS

SN 2 C, SN 3 C Types
Shaft Diameter 95 – 160 mm

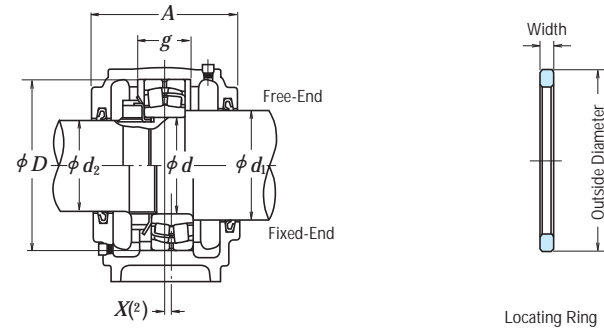
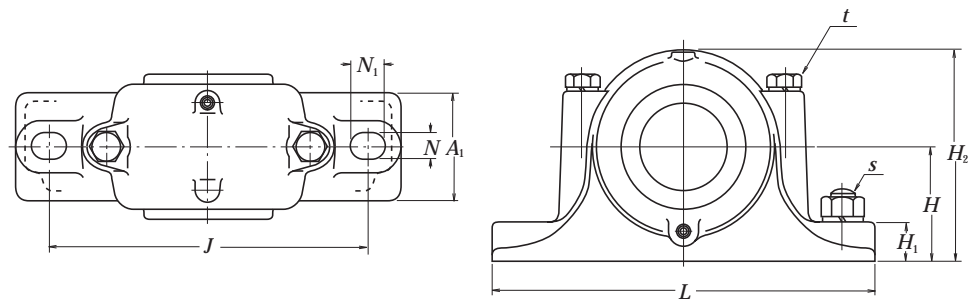

Shaft Diameter (mm) <i>d</i>	Plummer Block Bearing Box Numbers ⁽¹⁾	Dimensions (mm)														
		<i>d</i> ₁	<i>d</i> ₂	<i>D</i> _{H8}	<i>H</i> _{h13}	<i>J</i>	<i>N</i>	<i>N</i> ₁	<i>A</i>	<i>L</i>	<i>A</i> ₁	<i>H</i> ₁	<i>H</i> ₂	<i>g</i> _{H13}	<i>t</i> _{nominal}	<i>s</i> _{nominal}
95	SN 219 C	110	90	170	112	290	22	27	140	345	100	35	210	53	M16	M20
	SN 319 C	110	90	200	125	350	26	32	170	410	120	45	245	77	M20	M24
100	SN 220 C	115	95	180	112	320	26	32	160	380	110	40	218	70.3	M20	M24
	SN 320 C	115	95	215	140	350	26	32	175	410	120	45	270	83	M20	M24
110	SN 222 C	125	105	200	125	350	26	32	175	410	120	45	240	80	M20	M24
	SN 322 C	125	105	240	150	390	28	36	190	450	130	50	300	90	M24	M24
120	SN 224 C	135	115	215	140	350	26	32	185	410	120	45	270	86	M20	M24
	SN 324 C	135	115	260	160	450	33	42	200	530	160	60	320	96	M24	M30
130	SN 226 C	145	125	230	150	380	28	36	190	445	130	50	290	90	M24	M24
	SN 326 C	150	125	280	170	470	33	42	210	550	160	60	340	103	M24	M30
140	SN 228 C	155	135	250	150	420	33	42	205	500	150	50	305	98	M24	M30
	SN 328 C	160	135	300	180	520	35	45	235	610	170	65	365	112	M30	M30
150	SN 230 C	165	145	270	160	450	33	42	220	530	160	60	325	106	M24	M30
	SN 330 C	170	145	320	190	560	35	45	245	650	180	65	385	118	M30	M30
160	SN 232 C	175	150	290	170	470	33	42	235	550	160	60	345	114	M24	M30
	SN 332 C	180	150	340	200	580	42	50	255	680	190	70	405	124	M30	M36

Note ⁽¹⁾ Including oil seal.

To place an order for a complete unit, please specify, "Plummer block bearing box+bearing+nut+Lock-washer+locating ring".

- Remarks
- The threads for plugs are R 1/8 for SN219C, and R 1/4 for SN319C and SN220C and over.
 - Bearing boxes larger than SN320C and SN224C are provided with eye bolts.

Mass (kg) approx.	Applicable Parts							Oil Seals ⁽²⁾		
	Self-Aligning Ball Bearing Numbers	B. D. L. R. ⁽⁴⁾ C ₁ (N)	Spherical Roller Bearing Numbers	B. D. L. R. ⁽⁴⁾ C ₁ (N)	Nut Numbers	Lock-washer Numbers	Locating Ring Nominal (Outside Dia.×Width)	Q'ty	Side <i>d</i> ₁	Side <i>d</i> ₂
15	1219	64 000	—	—	AN 19	AW 19X	SR 170×10.5	2	GS 24	GS 20
	2219	84 000	22219 EAE4	330 000	AN 19	AW 19X	SR 170×10	1		
	2319	161 000	22319 EAE4	590 000	AN 19	AW 19X	SR 200×10	2	GS 24	GS 20
22	1319	129 000	21319 CE4	345 000	AN 19	AW 19X	SR 200×16	2	GS 24	GS 20
	2219	161 000	22319 EAE4	590 000	AN 19	AW 19X	SR 200×10	1		
	2319	161 000	22319 EAE4	590 000	AN 19	AW 19X	SR 200×10	2	GS 24	GS 20
18.5	1220	69 500	—	—	AN 20	AW 20X	SR 180×18.1	2	GS 26	GS 21
	2220	94 500	22220 EAE4	365 000	AN 20	AW 20X	SR 180×12.1	2		
	—	—	23220 CE4	420 000	AN 20	AW 20X	SR 180×10	1		
25	1320	140 000	21320 CE4	395 000	AN 20	AW 20X	SR 215×18	2	GS 26	GS 21
	2320	187 000	22320 EAE4	690 000	AN 20	AW 20X	SR 215×10	1		
	2320	187 000	22320 EAE4	690 000	AN 20	AW 20X	SR 215×10	2	GS 26	GS 21
20	1222	87 000	—	—	AN 22	AW 22X	SR 200×21	2	GS 28	GS 23
	2222	122 000	22222 EAE4	485 000	AN 22	AW 22X	SR 200×13.5	2		
	—	—	23222 CE4	515 000	AN 22	AW 22X	SR 200×10	1		
32	1322	161 000	21322 CAE4	395 000	AN 22	AW 22X	SR 240×20	2	GS 28	GS 23
	2322	211 000	22322 EAE4	825 000	AN 22	AW 22X	SR 240×10	1		
	2322	211 000	22322 EAE4	825 000	AN 22	AW 22X	SR 240×10	2	GS 28	GS 23
24.5	—	—	22224 EAE4	550 000	AN 24	AW 24	SR 215×14	2	GS 30	GS 26
	—	—	23224 CE4	630 000	AN 24	AW 24	SR 215×10	1		
48	—	—	22324 EAE4	955 000	AN 24	AW 24	SR 260×10	1	GS 30	GS 26
	—	—	22324 EAE4	955 000	AN 24	AW 24	SR 260×10	1	GS 30	GS 26
30	—	—	22226 EAE4	655 000	AN 26	AW 26	SR 230×13	2	GS 33	GS 28
	—	—	23226 CE4	700 000	AN 26	AW 26	SR 230×10	1		
56	—	—	22326 CE4	995 000	AN 26	AW 26	SR 280×10	1	GS 34	GS 28
	—	—	22326 CE4	995 000	AN 26	AW 26	SR 280×10	1	GS 34	GS 28
38	—	—	22228 CDE4	645 000	AN 28	AW 28	SR 250×15	2	GS 35	GS 30
	—	—	23228 CE4	835 000	AN 28	AW 28	SR 250×10	1		
72	—	—	22328 CE4	1 160 000	AN 28	AW 28	SR 300×10	1	GS 36	GS 30
	—	—	22328 CE4	1 160 000	AN 28	AW 28	SR 300×10	1	GS 36	GS 30
46	—	—	22230 CDE4	765 000	AN 30	AW 30	SR 270×16.5	2	GS 37	GS 33
	—	—	23230 CE4	975 000	AN 30	AW 30	SR 270×10	1		
98	—	—	22330 CAE4	1 220 000	AN 30	AW 30	SR 320×10	1	GS 38	GS 33
	—	—	22330 CAE4	1 220 000	AN 30	AW 30	SR 320×10	1	GS 38	GS 33
50	—	—	22232 CDE4	910 000	AN 32	AW 32	SR 290×17	2	GS 39	GS 34
	—	—	23232 CE4	1 100 000	AN 32	AW 32	SR 290×10	1		
115	—	—	22332 CAE4	1 360 000	AN 32	AW 32	SR 340×10	1	GS 40	GS 34
	—	—	22332 CAE4	1 360 000	AN 32	AW 32	SR 340×10	1	GS 40	GS 34

Notes ⁽²⁾ The *X* dimension indicates the offset of the bearing center from the center of the plummer block bearing box. When one locating ring is used, it is 1/2 of the locating ring width, and when two rings are used, it becomes 0.

⁽³⁾ Applicable to the ZF Type with the same number. ⁽⁴⁾ B. D. L. R. : Basic Dynamic Load Ratings

STEPPED-SHAFT TYPE PLUMMER BLOCKS

SD 2 C, SD 3 C Types
Shaft Diameter 170 – 320 mm

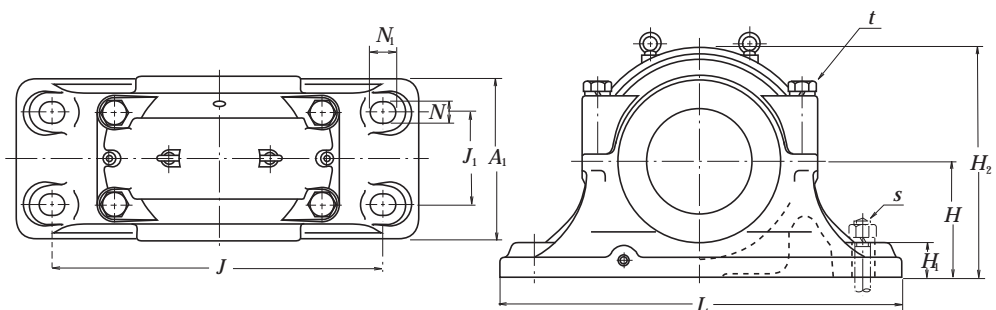

Shaft Diameter (mm) <i>d</i>	Plummer Block Bearing Box Numbers (1)		Dimensions (mm)												
	Free-End	Fixed-End	<i>d</i> ₁	<i>d</i> ₂	<i>D</i> _{H8}	<i>H</i> _{h13}	<i>J</i>	<i>N</i>	<i>N</i> ₁	<i>A</i>	<i>L</i>	<i>A</i> ₁	<i>H</i> ₁	<i>H</i> ₂	<i>J</i> ₁
			170	SD 234 C	SD 234 CG	190	160	310	180	510	36	46	270	620	250
	SD 334 C	SD 334 CG	190	160	360	210	610	36	46	300	740	290	65	420	170
180	SD 236 C	SD 236 CG	200	170	320	190	540	36	46	280	650	260	60	380	150
	SD 336 C	SD 336 CG	200	170	380	225	640	43	59	320	780	310	70	450	180
190	SD 238 C	SD 238 CG	210	180	340	200	570	36	46	290	700	280	65	400	160
	SD 338 C	SD 338 CG	210	180	400	240	680	43	59	330	820	320	70	475	190
200	SD 240 C	SD 240 CG	220	190	360	210	610	36	46	300	740	290	65	420	170
	SD 340 C	SD 340 CG	220	190	420	250	710	43	59	350	860	340	85	500	200
220	SD 244 C	SD 244 CG	240	210	400	240	680	43	59	330	820	320	70	475	190
	SD 344 C	SD 344 CG	240	210	460	280	770	43	59	360	920	350	85	550	210
240	SD 248 C	SD 248 CG	260	230	440	260	740	43	59	340	880	330	85	515	200
	SD 348 C	SD 348 CG	260	230	500	300	830	50	67	390	990	380	100	590	230
260	SD 252 C	SD 252 CG	280	250	480	280	790	43	59	370	940	360	85	560	210
	SD 352 C	SD 352 CG	280	250	540	325	890	50	67	410	1 060	400	100	640	250
280	SD 256 C	SD 256 CG	300	260	500	300	830	50	67	390	990	380	100	590	230
	SD 356 C	SD 356 CG	300	260	580	355	930	57	77	440	1 110	430	110	690	270
300	SD 260 C	SD 260 CG	320	280	540	325	890	50	67	410	1 060	400	100	640	250
320	SD 264 C	SD 264 CG	340	300	580	355	930	57	77	440	1 110	430	110	690	270

Note (1) Including oil seal.

To place an order for a complete unit, please specify, "Plummer block bearing box+bearing+nut+Lock-washer or stopper".

Remarks 1. The threads for oil replenishing hole plugs are R 1/4 and those for drain plugs are R 3/8.

2. The plummer block bearing boxes listed above are provided with eye bolts.

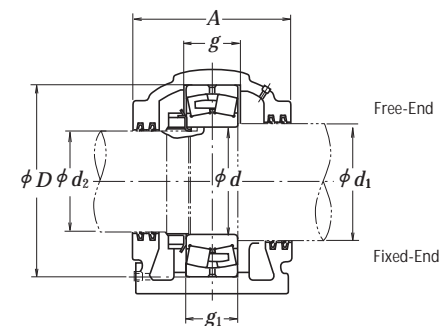

<i>g</i> _{H13}	<i>g</i> ₁ _{H13}	<i>t</i> _{nominal}	<i>s</i> _{nominal}	Mass (kg) approx.	Applicable Parts			Oil Seals (2)		
					Spherical Roller Bearing Numbers	Nut Basic Dynamic Load Ratings <i>C</i> _r (N)	Lock-washer or Stopper Numbers	Side <i>d</i> ₁	Side <i>d</i> ₂	
										96
130	120	M 30	M 30	160	22334 CAE4	1 580 000	AN 34	AW 34	GS 42	GS 36
96	86	M 24	M 30	110	22236 CDE4	1 020 000	AN 36	AW 36	GS 44	GS 38
136	126	M 30	M 36	195	22336 CAE4	1 740 000	AN 36	AW 36	GS 44	GS 38
102	92	M 30	M 30	130	22238 CAE4	1 140 000	AN 38	AW 38	GS 46	GS 40
142	132	M 30	M 36	210	22338 CAE4	1 890 000	AN 38	AW 38	GS 46	GS 40
108	98	M 30	M 30	155	22240 CAE4	1 300 000	AN 40	AW 40	GS 48	GS 42
148	138	M 36	M 36	240	22340 CAE4	2 000 000	AN 40	AW 40	GS 48	GS 42
118	108	M 30	M 36	205	22244 CAE4	1 570 000	AN 44	AL 44	GS 52	GS 46
155	145	M 36	M 36	315	22344 CAE4	2 350 000	AN 44	AL 44	GS 52	GS 46
130	120	M 36	M 36	240	22248 CAE4	1 870 000	AN 48	AL 44	GS 56	GS 50
165	155	M 36	M 42	405	22348 CAE4	2 600 000	AN 48	AL 44	GS 56	GS 50
140	130	M 36	M 36	315	22252 CAE4	2 180 000	AN 52	AL 52	GS 60	GS 54
175	165	M 36	M 42	480	22352 CAE4	3 100 000	AN 52	AL 52	GS 60	GS 54
140	130	M 36	M 42	390	22256 CAE4	2 280 000	AN 56	AL 52	GS 64	GS 56
185	175	M 42	M 48	610	22356 CAE4	3 500 000	AN 56	AL 52	GS 64	GS 56
150	140	M 36	M 42	465	22260 CAE4	2 610 000	AN 60	AL 60	GS 68	GS 60
160	150	M 42	M 48	595	22264 CAE4	2 990 000	AN 64	AL 64	GS 72	GS 64

Note (2) Applicable to the ZF Type with the same number.

CYLINDRICAL ROLLER BEARINGS FOR SHEAVES

CYLINDRICAL ROLLER BEARINGS FOR SHEAVES

Open Type	Bore Diameter 50 – 560mm	B328
Prelubricated Type	Bore Diameter 40 – 400mm	B332

DESIGN, TYPES, AND FEATURES

Cylindrical Roller Bearings for sheaves are specially designed thin-walled, broad-width, full-complement type double-row cylindrical roller bearings, but they are widely used also for general industrial machines running at low speed and under heavy loads. There are several series as shown in Table 1.

Table 1 Series of Cylindrical Roller Bearings for Sheaves

Bearing Type		Fixed-End	Free-End
Open Type	Without Snap Ring	RS-48E4 RS-49E4	RSF-48E4 RSF-49E4
	Shielded Type	Without Snap Ring With Snap Ring	RS-50 RS-50NR



Table 3 Units : μm

Nominal Bore Dia. d (mm)	Clearances			
	CN		C3	
over incl.	min.	max.	min.	max.
30 40	15	50	35	70
40 50	20	55	40	75
50 65	20	65	45	90
65 80	25	75	55	105
80 100	30	80	65	115
100 120	35	90	80	135
120 140	40	105	90	155
140 160	50	115	100	165
160 180	60	125	110	175
180 200	65	135	125	195
200 225	75	150	140	215
225 250	90	165	155	230
250 280	100	180	175	255
280 315	110	195	195	280
315 355	125	215	215	305
355 400	140	235	245	340
400 450	155	275	270	390
450 500	180	300	300	420

Since all are non-separable type bearings, the inner and outer rings cannot be separated, but the RSF type can be used as a free-end bearing. In this case, the permissible axial displacement is listed in the bearing tables.

Since cylindrical roller bearings for sheaves are a double-row, full-complement type, they can withstand heavy shock loads and moments and have sufficient axial load capacity for use in sheaves.

Since the shielded type is a kind of bearing unit, the number of parts surrounding the bearing can be reduced, so it allows for a simple compact design.

The surface of these bearings is treated for rust prevention.

TOLERANCES AND

RUNNING ACCURACY..... Table 8.2 (Pages A60 to A63)

RECOMMENDED FITS AND INTERNAL CLEARANCES

When used with outer ring rotation for sheaves or wheels, the fit and radial internal clearance should conform to Table 2.

Table 2 Fits and Internal Clearances for Cylindrical Roller Bearings for Sheaves

Operating Conditions		Fitting between Inner Ring and Shaft	Fitting between Outer Ring and Housing Bore	Recommended Internal Clearance
Outer Ring Rotation	Thin walled housings and heavy loads	g6 or h6	P7	C3
	Normal to heavy loads	g6 or h6	N7	C3
	Light or fluctuating loads	g6 or h6	M7	CN

The fits listed in Tables 9.2 (Page A84) and 9.4 (Page A85) apply when they are used with inner ring rotation in general applications, and the internal clearance should conform to Table 3.

RS-48 · RS-49 Types
RSF-48 · RSF-49 Types
Bore Diameter 50 – 220 mm

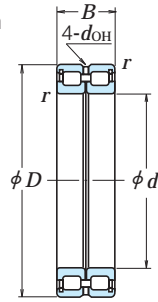

Fixed-End Bearing
RS

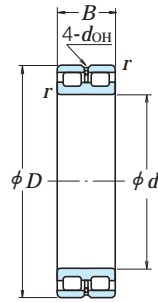

Free-End Bearing
RSF

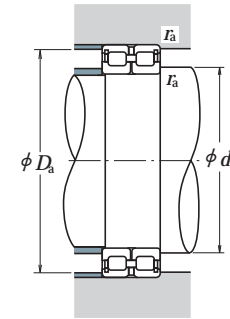

Boundary Dimensions (mm)				Basic Load Ratings (N)				Limiting Speeds (min ⁻¹)	
<i>d</i>	<i>D</i>	<i>B</i>	<i>r</i> _{min.}	<i>C_r</i>	<i>C_{0r}</i>	(kgf)		Grease	Oil
						<i>C_r</i>	<i>C_{0r}</i>		
50	72	22	0.6	48 000	75 500	4 900	7 700	2 000	4 000
60	85	25	1	68 500	118 000	6 950	12 000	1 600	3 200
65	90	25	1	70 500	125 000	7 150	12 700	1 600	3 200
70	100	30	1	102 000	168 000	10 400	17 200	1 400	2 800
80	110	30	1	109 000	191 000	11 100	19 500	1 300	2 600
90	125	35	1.1	147 000	268 000	15 000	27 400	1 100	2 200
100	125	25	1	87 500	189 000	8 900	19 300	1 100	2 200
	140	40	1.1	194 000	400 000	19 800	41 000	1 000	2 000
105	130	25	1	89 000	196 000	9 100	19 900	1 000	2 000
	145	40	1.1	199 000	420 000	20 300	43 000	950	1 900
110	140	30	1	114 000	260 000	11 700	26 500	950	1 900
	150	40	1.1	202 000	430 000	20 600	44 000	900	1 800
120	150	30	1	119 000	283 000	12 200	28 900	900	1 800
	165	45	1.1	226 000	480 000	23 100	49 000	800	1 600
130	165	35	1.1	162 000	390 000	16 500	39 500	800	1 600
	180	50	1.5	262 000	555 000	26 700	56 500	750	1 500
140	175	35	1.1	167 000	415 000	17 000	42 500	750	1 500
	190	50	1.5	272 000	595 000	27 700	60 500	710	1 400
150	190	40	1.1	235 000	575 000	23 900	58 500	670	1 400
	210	60	2	390 000	865 000	40 000	88 500	670	1 300
160	200	40	1.1	243 000	615 000	24 800	63 000	630	1 300
	220	60	2	410 000	930 000	41 500	95 000	600	1 200
170	215	45	1.1	265 000	650 000	27 000	66 500	600	1 200
	230	60	2	415 000	975 000	42 500	99 500	600	1 200
180	225	45	1.1	272 000	685 000	27 800	70 000	560	1 100
	250	69	2	495 000	1 130 000	50 500	115 000	530	1 100
190	240	50	1.5	315 000	785 000	32 000	80 000	530	1 100
	260	69	2	510 000	1 180 000	52 000	120 000	500	1 000
200	250	50	1.5	320 000	825 000	33 000	84 000	500	1 000
	280	80	2.1	665 000	1 500 000	68 000	153 000	480	950
220	270	50	1.5	340 000	905 000	34 500	92 500	450	900
	300	80	2.1	695 000	1 620 000	70 500	165 000	430	850

Remarks Cylindrical roller bearings for sheaves are designed for specific applications, when using them, please contact NSK.

Bearing Numbers ⁽¹⁾		Dimensions (mm)		Abutment and Fillet Dimensions (mm)			Mass (kg)
Fixed-End Bearing	Free-End Bearing	<i>d</i> _{OH} ⁽²⁾	Axial Disp. ⁽³⁾	<i>d</i> _a min.	<i>D</i> _a max.	<i>r</i> _a max.	approx.
RS-4910E4	RSF-4910E4	2.5	1.5	54	68	0.6	0.30
RS-4912E4	RSF-4912E4	2.5	1.5	65	80	1	0.46
RS-4913E4	RSF-4913E4	2.5	2	70	85	1	0.50
RS-4914E4	RSF-4914E4	3	2	75	95	1	0.79
RS-4916E4	RSF-4916E4	3	2	85	105	1	0.89
RS-4918E4	RSF-4918E4	3	2	96.5	118.5	1	1.35
RS-4820E4	RSF-4820E4	2.5	1.5	105	120	1	0.74
RS-4920E4	RSF-4920E4	3	2	106.5	133.5	1	1.97
RS-4821E4	RSF-4821E4	2.5	1.5	110	125	1	0.77
RS-4921E4	RSF-4921E4	3	2	111.5	138.5	1	2.05
RS-4822E4	RSF-4822E4	3	2	115	135	1	1.09
RS-4922E4	RSF-4922E4	3	2	116.5	143.5	1	2.15
RS-4824E4	RSF-4824E4	3	2	125	145	1	1.28
RS-4924E4	RSF-4924E4	4	3	126.5	158.5	1	2.95
RS-4826E4	RSF-4826E4	3	2	136.5	158.5	1	1.9
RS-4926E4	RSF-4926E4	5	3.5	138	172	1.5	3.95
RS-4828E4	RSF-4828E4	3	2	146.5	168.5	1	2.03
RS-4928E4	RSF-4928E4	5	3.5	148	182	1.5	4.25
RS-4830E4	RSF-4830E4	3	2	156.5	183.5	1	2.85
RS-4930E4	RSF-4930E4	5	3.5	159	201	2	6.65
RS-4832E4	RSF-4832E4	3	2	166.5	193.5	1	3.05
RS-4932E4	RSF-4932E4	5	3.5	169	211	2	7.0
RS-4834E4	RSF-4834E4	4	3	176.5	208.5	1	4.1
RS-4934E4	RSF-4934E4	4	3.5	179	221	2	7.35
RS-4836E4	RSF-4836E4	4	3	186.5	218.5	1	4.3
RS-4936E4	RSF-4936E4	6	4.5	189	241	2	10.7
RS-4838E4	RSF-4838E4	5	3.5	198	232	1.5	5.65
RS-4938E4	RSF-4938E4	6	4.5	199	251	2	11.1
RS-4840E4	RSF-4840E4	5	3.5	208	242	1.5	5.95
RS-4940E4	RSF-4940E4	7	5	211	269	2	15.7
RS-4844E4	RSF-4844E4	5	3.5	228	262	1.5	6.45
RS-4944E4	RSF-4944E4	7	5	231	289	2	17

Notes ⁽¹⁾ The suffix E4 indicates that the outer ring is provided with oil holes and oil groove.

⁽²⁾ *d*_{OH} represents the oil hole diameter in the outer ring.

⁽³⁾ Permissible axial displacement for free-end bearings.

RS-48 · RS-49 Types
 RSF-48 · RSF-49 Types
 Bore Diameter 240 – 560 mm

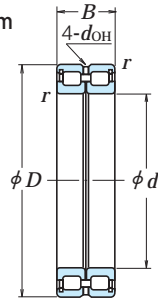

Fixed-End Bearing
RS

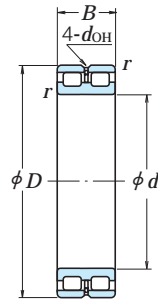

Free-End Bearing
RSF

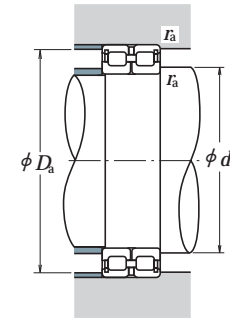

Boundary Dimensions (mm)				Basic Load Ratings				Limiting Speeds	
d	D	B	r min.	(N)		(kgf)		Grease	Oil
				C _r	C _{0r}	C _r	C _{0r}		
240	300	60	2	495 000	1 340 000	50 500	137 000	430	850
	320	80	2.1	725 000	1 770 000	74 000	181 000	400	800
260	320	60	2	515 000	1 450 000	52 500	148 000	380	750
	360	100	2.1	1 050 000	2 530 000	107 000	258 000	360	710
280	350	69	2	610 000	1 690 000	62 500	173 000	340	710
	380	100	2.1	1 090 000	2 720 000	111 000	277 000	340	670
300	380	80	2.1	805 000	2 160 000	82 000	220 000	320	630
	420	118	3	1 460 000	3 400 000	149 000	350 000	300	600
320	400	80	2.1	835 000	2 310 000	85 000	236 000	300	600
	440	118	3	1 500 000	3 600 000	153 000	365 000	280	560
340	420	80	2.1	855 000	2 430 000	87 500	248 000	280	560
	460	118	3	1 560 000	3 900 000	159 000	395 000	260	530
360	440	80	2.1	885 000	2 580 000	90 000	264 000	260	530
	480	118	3	1 600 000	4 050 000	163 000	415 000	260	500
380	480	100	2.1	1 260 000	3 600 000	128 000	365 000	240	500
	520	140	4	2 040 000	5 200 000	209 000	530 000	240	450
400	500	100	2.1	1 290 000	3 750 000	132 000	385 000	240	480
	540	140	4	2 100 000	5 450 000	214 000	555 000	220	450
420	520	100	2.1	1 320 000	3 950 000	135 000	405 000	220	450
	560	140	4	2 150 000	5 700 000	219 000	580 000	200	430
440	540	100	2.1	1 350 000	4 150 000	138 000	420 000	200	430
	600	160	4	2 840 000	7 350 000	289 000	750 000	190	380
460	580	118	3	1 730 000	5 150 000	177 000	525 000	190	380
	620	160	4	2 870 000	7 500 000	293 000	765 000	190	380
480	600	118	3	1 760 000	5 300 000	180 000	545 000	190	380
	650	170	5	3 200 000	8 500 000	325 000	865 000	180	360
500	620	118	3	1 810 000	5 600 000	184 000	570 000	180	360
	670	170	5	3 300 000	8 900 000	335 000	910 000	170	340
530	710	180	5	3 400 000	9 200 000	350 000	935 000	160	320
560	750	190	5	3 800 000	10 100 000	385 000	1 030 000	150	300

Bearing Numbers ⁽¹⁾		Dimensions (mm)		Abutment and Fillet Dimensions (mm)			Mass (kg)
Fixed-End Bearing	Free-End Bearing	d _{OH} ⁽²⁾	Axial Disp. ⁽³⁾	d _a min.	D _a max.	r _a max.	approx.
RS-4848E4	RSF-4848E4	5	3.5	249	291	2	10.3
RS-4948E4	RSF-4948E4	7	5	251	309	2	18.4
RS-4852E4	RSF-4852E4	5	3.5	269	311	2	11
RS-4952E4	RSF-4952E4	8	6	271	349	2	32
RS-4856E4	RSF-4856E4	6	4.5	289	341	2	16
RS-4956E4	RSF-4956E4	8	6	291	369	2	34
RS-4860E4	RSF-4860E4	6	5	311	369	2	23
RS-4960E4	RSF-4960E4	9	7	313	407	2.5	52
RS-4864E4	RSF-4864E4	6	5	331	389	2	24.3
RS-4964E4	RSF-4964E4	9	7	333	427	2.5	55
RS-4868E4	RSF-4868E4	6	5	351	409	2	25.6
RS-4968E4	RSF-4968E4	9	7	353	447	2.5	58
RS-4872E4	RSF-4872E4	6	5	371	429	2	27
RS-4972E4	RSF-4972E4	9	7	373	467	2.5	61
RS-4876E4	RSF-4876E4	8	6	391	469	2	45.5
RS-4976E4	RSF-4976E4	11	8	396	504	3	90.5
RS-4880E4	RSF-4880E4	8	6	411	489	2	47.5
RS-4980E4	RSF-4980E4	11	8	416	524	3	94.5
RS-4884E4	RSF-4884E4	8	6	431	509	2	49.5
RS-4984E4	RSF-4984E4	11	8	436	544	3	98.5
RS-4888E4	RSF-4888E4	8	6	451	529	2	51.5
RS-4988E4	RSF-4988E4	11	8	456	584	3	136
RS-4892E4	RSF-4892E4	9	7	473	567	2.5	77.5
RS-4992E4	RSF-4992E4	11	8	476	604	3	142
RS-4896E4	RSF-4896E4	9	7	493	587	2.5	80.5
RS-4996E4	RSF-4996E4	12	9	500	630	4	167
RS-48/500E4	RSF-48/500E4	9	7	513	607	2.5	83.5
RS-49/500E4	RSF-49/500E4	12	9	520	650	4	173
RS-49/530E4	RSF-49/530E4	12	11	550	690	4	206
RS-49/560E4	RSF-49/560E4	12	11	580	730	4	231

Remarks Cylindrical roller bearings for sheaves are designed for specific applications, when using them, please contact NSK.

Notes ⁽¹⁾ The suffix E4 indicates that the outer ring is provided with oil holes and oil groove.

⁽²⁾ d_{OH} represents the oil hole diameter in the outer ring.

⁽³⁾ Permissible axial displacement for free-end bearings.

RS-50 Type (Prelubricated)
Bore Diameter 40 – 400 mm

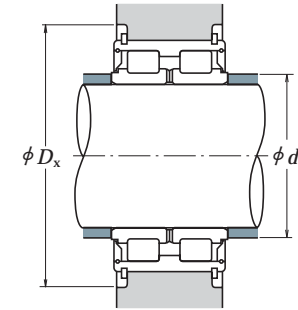
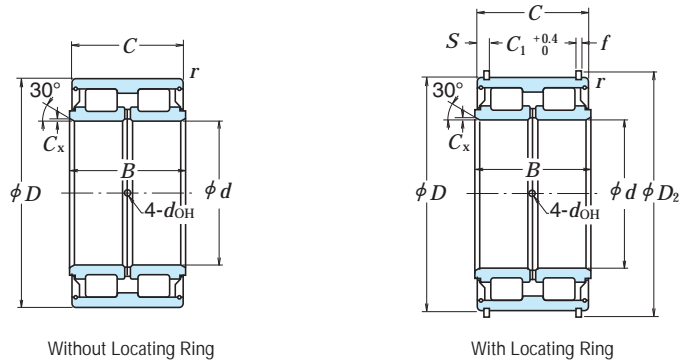

Boundary Dimensions (mm)						Basic Load Ratings				Limiting Speeds (min ⁻¹) Grease
d	D	B	C	C _x ⁽¹⁾ min.	r min.	C _r (N)	C _{0r} (kgf)	C _r (kgf)	C _{0r} (kgf)	
40	68	38	37	0.4	0.6	79 500	116 000	8 100	11 800	2 400
45	75	40	39	0.4	0.6	95 500	144 000	9 750	14 700	2 200
50	80	40	39	0.4	0.6	100 000	158 000	10 200	16 100	2 000
55	90	46	45	0.6	0.6	118 000	193 000	12 100	19 700	1 800
60	95	46	45	0.6	0.6	123 000	208 000	12 600	21 200	1 700
65	100	46	45	0.6	0.6	128 000	224 000	13 100	22 800	1 600
70	110	54	53	0.6	0.6	171 000	285 000	17 500	29 000	1 400
75	115	54	53	0.6	0.6	179 000	305 000	18 200	31 500	1 400
80	125	60	59	0.6	0.6	251 000	430 000	25 600	43 500	1 200
85	130	60	59	0.6	0.6	256 000	445 000	26 200	45 500	1 200
90	140	67	66	1	0.6	305 000	540 000	31 000	55 000	1 100
95	145	67	66	1	0.6	310 000	565 000	32 000	57 500	1 100
100	150	67	66	1	0.6	320 000	585 000	32 500	59 500	1 000
110	170	80	79	1.1	1	385 000	695 000	39 000	71 000	900
120	180	80	79	1.1	1	400 000	750 000	40 500	76 500	850
130	200	95	94	1.1	1	535 000	1 000 000	54 500	102 000	750
140	210	95	94	1.1	1	550 000	1 040 000	56 000	106 000	710
150	225	100	99	1.3	1	620 000	1 210 000	63 500	124 000	670
160	240	109	108	1.3	1.1	695 000	1 370 000	71 000	140 000	630
170	260	122	121	1.3	1.1	860 000	1 680 000	88 000	171 000	600
180	280	136	135	1.3	1.1	980 000	1 910 000	100 000	195 000	530
190	290	136	135	1.3	1.1	1 120 000	2 230 000	114 000	227 000	500
200	310	150	149	1.3	1.1	1 310 000	2 650 000	133 000	270 000	480
220	340	160	159	1.5	1.1	1 510 000	3 100 000	154 000	320 000	430
240	360	160	159	1.5	1.1	1 570 000	3 350 000	160 000	340 000	400
260	400	190	189	2	1.5	2 130 000	4 500 000	217 000	460 000	360
280	420	190	189	2	1.5	2 170 000	4 700 000	221 000	480 000	340
300	460	218	216	2	1.5	2 670 000	5 850 000	272 000	600 000	300
320	480	218	216	2	1.5	2 720 000	6 100 000	277 000	620 000	300
340	520	243	241	2.1	2	3 350 000	7 550 000	345 000	770 000	260
360	540	243	241	2.1	2	3 450 000	7 850 000	350 000	800 000	260
380	560	243	241	2.1	2	3 550 000	8 400 000	365 000	855 000	240
400	600	272	270	2.1	2	4 250 000	9 950 000	435 000	1 010 000	220

Note (1) Chamfer dimension of inner ring in radial direction.

- Remarks 1. Good quality grease is prepacked in bearings.
2. Grease can be supplied through oil holes in the inner rings.

Bearing Numbers		Locating Ring Dimensions (mm)				Oil Holes (mm)	Abutment and Fillet Dimensions (mm)		Mass (kg)
Without Locating Ring	With Locating Ring	C ₁	S	D ₂	f	d _{OH}	d _a min.	D _x min.	approx.
RS-5008	RS-5008NR	28	4.5	71.8	2	2.5	43.5	77.5	0.56
RS-5009	RS-5009NR	30	4.5	78.8	2	2.5	48.5	84.5	0.70
RS-5010	RS-5010NR	30	4.5	83.8	2	2.5	53.5	89.5	0.76
RS-5011	RS-5011NR	34	5.5	94.8	2.5	3	60	101	1.17
RS-5012	RS-5012NR	34	5.5	99.8	2.5	3	65	106	1.25
RS-5013	RS-5013NR	34	5.5	104.8	2.5	3	70	111	1.32
RS-5014	RS-5014NR	42	5.5	114.5	2.5	3	75	121	1.87
RS-5015	RS-5015NR	42	5.5	119.5	2.5	3	80	126	2.0
RS-5016	RS-5016NR	48	5.5	129.5	2.5	3	85	136	2.65
RS-5017	RS-5017NR	48	5.5	134.5	2.5	3	90	141	2.75
RS-5018	RS-5018NR	54	6	145.4	2.5	4	96	153.5	3.75
RS-5019	RS-5019NR	54	6	150.4	2.5	4	101	158.5	3.95
RS-5020	RS-5020NR	54	6	155.4	2.5	4	106	163.5	4.05
RS-5022	RS-5022NR	65	7	175.4	2.5	5	116.5	183.5	6.1
RS-5024	RS-5024NR	65	7	188	3	5	126.5	197	7.0
RS-5026	RS-5026NR	77	8.5	207	3	5	136.5	217	10.6
RS-5028	RS-5028NR	77	8.5	217	3	5	146.5	227	11.3
RS-5030	RS-5030NR	81	9	232	3	6	157	242	13.7
RS-5032	RS-5032NR	89	9.5	247	3	6	167	257	16.8
RS-5034	RS-5034NR	99	11	270	4	6	177	285	22.2
RS-5036	RS-5036NR	110	12.5	294	5	6	187	318	30
RS-5038	RS-5038NR	110	12.5	304	5	6	197	328	32
RS-5040	RS-5040NR	120	14.5	324	5	6	207	352	41
RS-5044	RS-5044NR	130	14.5	356	6	7	228.5	382	53
RS-5048	RS-5048NR	130	14.5	376	6	7	248.5	402	57
RS-5052	RS-5052NR	154	17.5	416	7	8	270	444	86
RS-5056	RS-5056NR	154	17.5	436	7	8	290	472	92
RS-5060	RS-5060NR	178	19	476	7	8	310	512	130
RS-5064	—	—	—	—	—	8	330	—	135
RS-5068	—	—	—	—	—	10	352	—	185
RS-5072	—	—	—	—	—	10	372	—	192
RS-5076	—	—	—	—	—	10	392	—	196
RS-5080	—	—	—	—	—	10	412	—	280

- Remarks 3. Cylindrical roller bearings for sheaves are designed for specific applications, when using them, please contact NSK.
4. For shield with outside diameter larger than 180mm, the above figure is different actual shape. For detail drawing, please contact NSK.

ROLL-NECK BEARINGS

FOUR-ROW
TAPERED ROLLER BEARINGS

Bore Diameter 100 – 939.800mm B338

FOUR-ROW
CYLINDRICAL ROLLER BEARINGS

Bore Diameter 100 – 920mm B340

DESIGN, TYPES, AND FEATURES

Four-row tapered roller bearings and four-row cylindrical roller bearings used for rolling-mill roll necks are easy to service and check, and are designed to have the highest load rating possible for the limited space around roll necks. Also, they are designed for high speed to satisfy the demand for fast rolling.

In addition to the open type (KV) four-row tapered roller bearings listed in this catalog, sealed-clean type four-row tapered roller bearings are also available. Please refer to "Large-Size Rolling Bearings" catalog (CAT. No. E125) or "Extra-Capacity Sealed-Clean™ Roll Neck Bearings" catalog (CAT. No. E1225) for more detailed information.

TOLERANCES AND RUNNING ACCURACY

METRIC DESIGN FOUR-ROW
TAPERED ROLLER BEARINGS Table 8.3 (Pages A64 to A67)

INCH DESIGN FOUR-ROW
TAPERED ROLLER BEARINGS Table 8.4 (Pages A68 to A69)

FOUR-ROW
CYLINDRICAL ROLLER BEARINGS Table 8.2 (Pages A60 to A63)
(Not applicable to combined width)

RECOMMENDED FITS

FOUR-ROW TAPERED ROLLER BEARINGS (CYLINDRICAL BORES)

Tables 1 and 2 apply to metric series bearings and Tables 3 and 4 to inch design.

Table 1 Fits of Metric Design Four-Row Tapered Roller Bearings with Roll Necks

Units : μm

Nominal Bore Diameter d (mm)	Single Plane Mean Bore Dia. Deviation Δd_{mp}			Tolerance		Clearance		Wear Limits
		over	incl.	high	low	min.	max.	Ref.
80	120	0	-20	-120	-150	100	150	300
120	180	0	-25	-150	-175	125	175	350
180	250	0	-30	-175	-200	145	200	400
250	315	0	-35	-210	-250	175	250	500
315	400	0	-40	-240	-300	200	300	600
400	500	0	-45	-245	-300	200	300	600
500	630	0	-50	-250	-300	200	300	600
630	800	0	-75	-325	-400	250	400	800

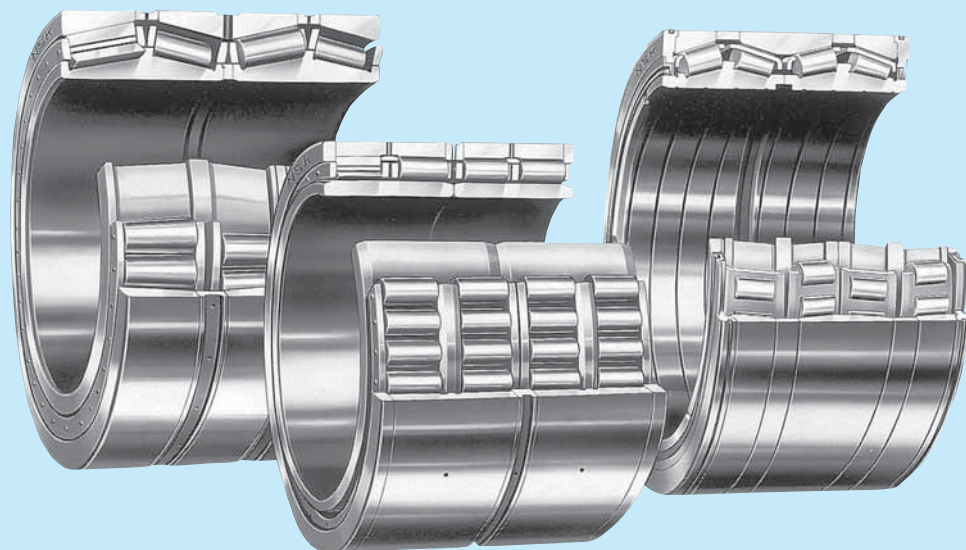

Table 2 Fits of Metric Design Four-Row Tapered Roller Bearings with Chock

Units : μm

Nominal Outside Diameter D (mm)		Single Plane Mean Outside Dia. Deviation ΔD_{mp}		Tolerance for Chock Bore Diameter		Clearance		Wear Limits of Chock
over	incl.	high	low	high	low	min.	max.	Ref.
120	150	0	-18	+57	+25	25	75	150
150	180	0	-25	+100	+50	50	125	250
180	250	0	-30	+120	+50	50	150	300
250	315	0	-35	+115	+50	50	150	300
315	400	0	-40	+110	+50	50	150	300
400	500	0	-45	+105	+50	50	150	300
500	630	0	-50	+100	+50	50	150	300
630	800	0	-75	+150	+75	75	225	450
800	1 000	0	-100	+150	+75	75	250	500

Table 3 Fits of Inch Design Four-Row Tapered Roller Bearings with Roll Necks

Units : μm

Nominal Bore Diameter d				Bore Diameter Deviation Δd_s		Tolerance for Roll Neck Diameter		Clearance		Wear Limits of Roll Neck
over		incl.		high	low	high	low	min.	max.	Ref.
(mm)	1/25.4	(mm)	1/25.4							
152.400	6.0000	203.200	8.0000	+25	0	-150	-175	150	200	400
203.200	8.0000	304.800	12.0000	+25	0	-175	-200	175	225	450
304.800	12.0000	609.600	24.0000	+51	0	-200	-250	200	301	600
609.600	24.0000	914.400	36.0000	+76	0	-250	-325	250	401	800
914.400	36.0000	—	—	+102	0	-300	-400	300	502	1 000

Table 4 Fits of Inch Design Four-Row Tapered Roller Bearings with Chocks

Units : μm

Nominal Outside Diameter D				Outside Dia. Deviation ΔD_s		Tolerance for Chock Bore Diameter		Clearance		Wear Limits of Chock
over		incl.		high	low	high	low	min.	max.	Ref.
(mm)	1/25.4	(mm)	1/25.4							
—	—	304.800	12.0000	+25	0	+75	+50	25	75	150
304.800	12.0000	609.600	24.0000	+51	0	+150	+100	49	150	300
609.600	24.0000	914.400	36.0000	+76	0	+225	+150	74	225	450
914.400	36.0000	1 219.200	48.0000	+102	0	+300	+200	98	300	600
1 219.200	48.0000	1 524.000	60.0000	+127	0	+375	+250	123	375	750

FOUR-ROW CYLINDRICAL ROLLER BEARINGS (CYLINDRICAL BORES)

When they are used on backup rolls of four stage rolling mills, the tolerances for roll neck diameters are shown in Table 5. For the fitting between the bearing and chock bore, we recommend G7.

For the fitting of four-row cylindrical roller bearings on the roll necks of other rolling mills, Table 9.2 (Page A84) and Table 9.4 (Page A85) usually apply.

Table 5 Recommended Backup Roll Neck Tolerances

Units : μm

Nominal Bore Diameter d		Tolerances for Roll Neck Diameter	
over	incl.	high	low
280	355	+0.165	+0.13
355	400	+0.19	+0.15
400	450	+0.22	+0.17
450	500	+0.25	+0.19
500	560	+0.28	+0.21
560	630	+0.32	+0.25
630	710	+0.35	+0.27
710	800	+0.39	+0.31
800	900	+0.44	+0.35
900	1 000	+0.48	+0.39

INTERNAL CLEARANCES

FOUR-ROW TAPERED ROLLER BEARINGS

The radial internal clearances in four-row tapered roller bearings (cylindrical bores) used on rolling mill roll necks with a loose fit are C2 or often smaller than C2. The NSK standard clearances for four-row tapered roller bearings for roll necks are shown in Table 6. Depending on the operating conditions, special radial clearance selection may become necessary, please contact NSK in such a case.

The internal clearance in four-row tapered roller bearings is peadjusted for individual bearing sets, therefore it is necessary to use each part of a given set by observing mating marks when assembling them.

FOUR-ROW CYLINDRICAL ROLLER BEARINGS

Please contact NSK regarding internal clearance.

Table 6 Standard Radial Internal Clearances in Four-Row Tapered Roller Bearings (Cylindrical Bores)

Units : μm

Nominal Bore Diameter d (mm)		Radial Internal Clearance	
over	incl.	min.	max.
80	120	25	45
120	180	30	50
180	250	40	60
250	315	50	70
315	400	60	80
400	500	70	90
500	630	80	100
630	800	100	120
800	1 000	120	140

Bore Diameter 100 – 939.800 mm

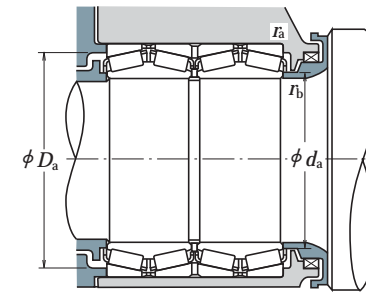
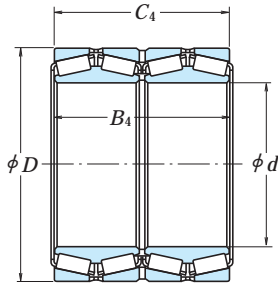

Boundary Dimensions (mm)				Basic Load Ratings (N) (kgf)			
<i>d</i>	<i>D</i>	<i>B</i> ₄	<i>C</i> ₄	<i>C</i> _r	<i>C</i> _{0r}	<i>C</i> _r	<i>C</i> _{0r}
100	140	104	104	320 000	765 000	32 500	78 000
120	170	124	124	475 000	1 080 000	48 000	110 000
135	180	160	160	455 000	1 280 000	46 500	130 000
150	212	155	155	750 000	1 880 000	76 500	192 000
165.100	225.425	165.100	168.275	705 000	2 160 000	72 000	220 000
177.800	247.650	192.088	192.088	950 000	2 570 000	97 000	262 000
190.500	266.700	187.325	188.912	1 010 000	2 870 000	103 000	293 000
206.375	282.575	190.500	190.500	995 000	2 870 000	101 000	292 000
228.600	400.050	296.875	296.875	2 570 000	5 450 000	262 000	555 000
240	338	248	248	1 960 000	5 300 000	199 000	540 000
244.475	327.025	193.675	193.675	1 300 000	3 700 000	132 000	375 000
254.000	358.775	269.875	269.875	2 230 000	6 150 000	227 000	630 000
266.700	355.600	230.188	228.600	1 810 000	5 050 000	185 000	515 000
279.400	393.700	269.875	269.875	2 010 000	5 450 000	205 000	555 000
304.648	438.048	280.990	279.400	2 600 000	6 750 000	265 000	685 000
343.052	457.098	254.000	254.000	2 520 000	7 250 000	256 000	740 000
368.300	523.875	382.588	382.588	5 050 000	14 900 000	515 000	1 520 000
384.175	546.100	400.050	400.050	5 750 000	16 600 000	585 000	1 700 000
406.400	546.100	288.925	288.925	2 960 000	8 550 000	300 000	875 000
415.925	590.550	434.975	434.975	6 450 000	19 500 000	655 000	1 990 000
457.200	596.900	276.225	279.400	3 300 000	10 000 000	335 000	1 020 000
479.425	679.450	495.300	495.300	8 200 000	25 500 000	840 000	2 600 000
482.600	615.950	330.200	330.200	4 100 000	13 800 000	415 000	1 410 000
500	705	515	515	8 350 000	26 600 000	850 000	2 710 000
509.948	654.924	377.000	379.000	4 700 000	16 100 000	480 000	1 640 000
558.800	736.600	409.575	409.575	6 050 000	19 400 000	620 000	1 980 000
571.500	812.800	593.725	593.725	11 700 000	37 000 000	1 200 000	3 800 000
609.600	787.400	361.950	361.950	5 750 000	18 700 000	585 000	1 910 000
635	900	660	660	13 300 000	43 500 000	1 350 000	4 400 000
685.800	876.300	352.425	355.600	6 350 000	22 200 000	645 000	2 270 000
711.200	914.400	317.500	317.500	5 500 000	19 300 000	560 000	1 970 000
749.300	990.600	605.000	605.000	13 000 000	47 000 000	1 330 000	4 800 000
762.000	1 066.800	723.900	736.600	18 000 000	59 500 000	1 840 000	6 050 000
840.000	1 170.000	840.000	840.000	22 200 000	76 000 000	2 260 000	7 750 000
939.800	1 333.500	952.500	952.500	26 900 000	92 000 000	2 740 000	9 400 000

Bearing Numbers	Abutment and Fillet Dimensions (mm)				Mass (kg) approx.	Reference Numbers
	<i>d</i> _a	<i>D</i> _a	<i>r</i> _a max.	<i>r</i> _b max.		
100 KV 895	109	130	2	1.5	4.9	—
120 KV 895	131	158	2	2	8.5	—
135 KV 1802	145	169	1.5	2	11.1	—
150 KV 895	162	196	2	2	17	—
*165 KV 2252	178	209	3.3	0.8	20.2	46791D -720-721D
*177 KV 2452	192	228	3.3	1.5	27.9	67791D -720-721D
*190 KV 2651	204	246	3.3	1.5	32.8	67885D -820-820D
*206 KV 2854	218	261	3.3	0.8	35.2	67986D -920-921D
*228 KV 4051	264	367	3.3	3.3	152	EE 529091D -157-158XD
240 KV 895	257	315	2.5	2.5	68.5	—
*244 KV 3251	260	306	3.3	1.5	44.6	LM 247748D -710-710D
*254 KV 3551	272	335	3.3	1.5	85.6	M 249748DW -710-710D
*266 KV 3552	281	335	3.3	1.5	60.6	LM 451349D -310-310D
*279 KV 3951	302	363	6.4	1.5	100	EE 135111D -155-156XD
*304 KV 4353	329	407	4.8	3.3	133	M 757448DW -410-410D
*343 KV 4555	362	430	3.3	1.5	114	LM 761649DW -610-610D
*368 KV 5251	396	487	6.4	3.3	274	HM 265049D -010-010D
*384 KV 5452	417	510	6.4	3.3	309	HM 266449D -410-410D
*406 KV 5455	430	512	6.4	1.5	186	LM 767749DW -710-710D
*415 KV 5951	451	550	6.4	3.3	395	M 268749D -710-710D
*457 KV 5952	487	566	3.3	1.5	201	L 770849DW -810-810D
*479 KV 6751	520	635	6.4	3.3	595	M 272749DW -710-710D
*482 KV 6152	508	582	6.4	3.3	242	LM 272249DW -210-210D
500 KV 895	544	657	5	5	654	—
*509 KV 6551	536	619	6.4	1.5	312	—
*558 KV 7352	588	697	6.4	3.3	457	LM 377449DW -410-410D
*571 KV 8151	622	755	6.4	3.3	1 020	M 278749DW -710-710D
*609 KV 7851 A	644	745	6.4	3.3	454	EE 649241DW -310-311D
635 KV 9001	695	840	5	4	1 380	—
*685 KV 8751	730	833	6.4	3.3	543	EE 655271DW -345-346D
*711 KV 9151	770	870	6.4	3.3	549	EE 755281DW -360-361D
*749 KV 9951	804	940	6.4	3.3	1 310	LM 283649DW -610-610D
*762 KV 1051	828	996	12.7	5	2 100	—
*840 KV 1151	910	1 095	7	7	2 900	—
*939 KV 1351	1 035	1 245	12.7	4.8	4 380	LM 287849DW -810-810D

Note (*) Bearings marked * are inch design.

Remarks 1. For four-row tapered roller bearings not listed above, please contact NSK.

2. Four-row tapered roller bearings are designed for specific applications, when using them, please contact NSK.

Bore Diameter 100 – 330 mm

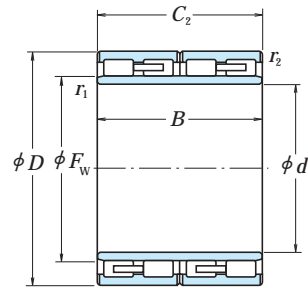

Figure 1

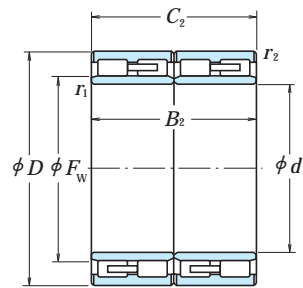

Figure 2

d	Boundary Dimensions (mm)						Basic Load Ratings			
	D	B, B ₂	C ₂	F _w	r ₁ min.	r ₂ min.	(N) C _r	(kgf) C _{0r}	C _r	C _{0r}
100	140	104	104	111	1.5	1.1	345 000	820 000	35 000	84 000
145	225	156	156	169	2	2	835 000	1 820 000	85 000	185 000
150	220	150	150	168	2	2	770 000	1 700 000	78 500	174 000
	230	156	156	174	2	2	825 000	1 810 000	84 500	185 000
160	230	130	130	178	2	2	665 000	1 340 000	68 000	136 000
	230	168	168	180	2	2	895 000	2 200 000	91 500	225 000
170	250	168	168	192	2.1	2.1	1 040 000	2 320 000	106 000	237 000
	255	180	180	193	2.1	2.1	1 130 000	2 500 000	115 000	255 000
180	250	156	156	200	2	2	880 000	2 230 000	89 500	227 000
	260	168	168	202	2.1	2.1	990 000	2 300 000	101 000	235 000
190	260	168	168	212	2	2	980 000	2 600 000	100 000	265 000
	270	200	200	212	2.1	2.1	1 260 000	3 100 000	128 000	315 000
200	280	200	200	224	2.1	2.1	1 210 000	3 200 000	123 000	325 000
	290	192	192	226	2.1	2.1	1 220 000	3 000 000	124 000	305 000
220	310	192	192	247	2.1	2.1	1 320 000	3 450 000	134 000	350 000
	310	225	225	245	2.1	2.1	1 500 000	3 900 000	153 000	395 000
	320	210	210	248	2.1	2.1	1 530 000	3 650 000	156 000	375 000
230	330	206	206	260	2.1	2.1	1 510 000	3 900 000	154 000	395 000
	340	260	260	261	3	3	2 050 000	5 100 000	209 000	520 000
240	330	220	220	270	3	3	1 520 000	4 400 000	155 000	445 000
	250	350	220	220	278	3	3	1 660 000	4 200 000	169 000
260	370	220	220	292	3	3	1 760 000	4 450 000	179 000	455 000
	380	280	280	294	3	3	2 420 000	6 250 000	247 000	635 000
270	380	230	230	298	2.1	2.1	2 000 000	5 050 000	204 000	515 000
	280	390	220	220	312	3	3	1 820 000	4 800 000	186 000
300	400	300	300	328	2	2	2 330 000	6 900 000	238 000	700 000
	420	240	240	332	3	3	2 280 000	5 750 000	233 000	585 000
310	430	240	240	344.5	3	3	2 240 000	5 950 000	228 000	605 000
320	450	240	240	355	3	3	2 320 000	5 750 000	237 000	585 000
330	460	340	340	365	4	4	3 050 000	8 650 000	310 000	880 000

Bearing Numbers	Mass (kg) approx.	Figures	Reference Bearing Numbers
100 RV 1401	4	2	—
145 RV 2201	23	1	313924A
150 RV 2201	20	1	—
150 RV 2302	23	1	313891A
160 RV 2301	16	1	—
160 RV 2302	22	1	—
170 RV 2501	27	1	—
170 RV 2503	31	1	—
180 RV 2501	23	1	—
180 RV 2601	29	1	313812
190 RV 2601	26	1	—
190 RV 2701	36	1	314199B
200 RV 2801	38	1	—
200 RV 2901	42	1	313811
220 RV 3101	46	1	—
220 RV 3102	52	1	—
220 RV 3201	56	1	—
230 RV 3301	58	1	313824
230 RV 3401	81	1	—
240 RV 3301	57	1	313921
250 RV 3501	64	1	—
260 RV 3701	76	1	313823
260 RV 3801	107	1	—
270 RV 3801	83	1	—
280 RV 3901	80	1	313822
300 RV 4021	103	2	—
300 RV 4201	101	1	—
310 RV 4301	107	1	—
320 RV 4502	116	1	—
330 RV 4601	174	1	—

- Remarks
1. For four-row cylindrical roller bearings not listed above, please contact NSK.
 2. Four-row cylindrical roller bearings are designed for specific applications, when using them, please contact NSK.

Bore Diameter 370 – 920 mm

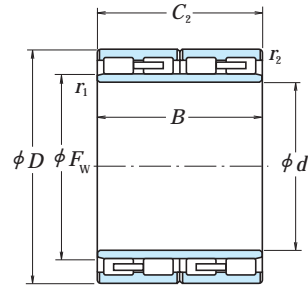

Figure 1

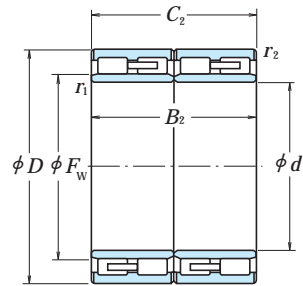

Figure 2

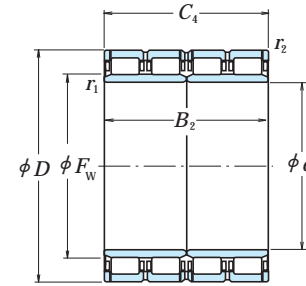

Figure 3

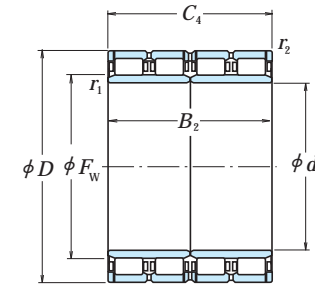

Figure 4

<i>d</i>	Boundary Dimensions (mm)					Basic Load Ratings (N) (kgf)				
	<i>D</i>	<i>B, B₂</i>	<i>C₂</i>	<i>F_w</i>	<i>r₁</i> min.	<i>r₂</i> min.	<i>C_r</i>	<i>C_{0r}</i>	<i>C_r</i>	<i>C_{0r}</i>
370	540	400	400	415	4	4	4 500 000	12 000 000	460 000	1 230 000
380	540	400	400	424	5	5	4 300 000	12 000 000	440 000	1 220 000
390	550	400	400	434	5	5	4 400 000	12 400 000	450 000	1 260 000
400	560	410	410	445	5	2	5 600 000	16 500 000	575 000	1 680 000
430	591	420	420	476	4	4	4 450 000	13 400 000	455 000	1 370 000
440	620	450	450	490	4	4	6 350 000	19 000 000	650 000	1 940 000
450	630	450	450	500	4	4	5 950 000	17 500 000	605 000	1 780 000
460	670	500	500	522	6	6	7 650 000	22 700 000	780 000	2 320 000
480	680	500	500	534	5	5	7 700 000	23 100 000	785 000	2 360 000
500	690	510	510	552	5	5	7 750 000	24 600 000	790 000	2 500 000
	700	515	515	554	5	5	7 800 000	23 800 000	800 000	2 430 000
	720	530	530	560	6	6	8 550 000	25 300 000	870 000	2 580 000
520	735	535	535	574.5	5	5	8 900 000	26 300 000	910 000	2 680 000
530	780	570	570	601	6	6	10 100 000	29 200 000	1 030 000	2 980 000
570	815	594	594	628	6	6	11 700 000	33 500 000	1 190 000	3 450 000
610	870	660	660	680	6	6	13 200 000	41 500 000	1 340 000	4 250 000
650	920	690	690	723	7.5	7.5	14 200 000	45 000 000	1 450 000	4 600 000
690	980	715	715	767.5	7.5	7.5	15 300 000	48 000 000	1 560 000	4 900 000
700	930	620	620	763	6	6	11 100 000	38 000 000	1 130 000	3 900 000
	980	700	700	774	6	6	15 300 000	49 000 000	1 560 000	5 000 000
725	1 000	700	700	796	6	6	15 600 000	51 000 000	1 590 000	5 200 000
760	1 080	805	790	845	6	6	19 000 000	61 000 000	1 940 000	6 200 000
800	1 080	750	750	880	6	6	16 000 000	56 500 000	1 630 000	5 750 000
820	1 160	840	840	911	7.5	7.5	21 900 000	71 500 000	2 230 000	7 300 000
	1 100	745	720	892	6	3	16 900 000	58 500 000	1 720 000	6 000 000
850	1 180	850	850	940	7.5	7.5	21 100 000	72 000 000	2 150 000	7 350 000
860	1 130	670	670	934	6	6	15 700 000	56 500 000	1 600 000	5 800 000
	1 160	735	710	940	7.5	4	17 500 000	60 000 000	1 780 000	6 100 000
900	1 230	895	870	985	7.5	7.5	22 100 000	76 000 000	2 250 000	7 750 000
920	1 280	865	850	1 015	7.5	7.5	24 000 000	80 000 000	2 450 000	8 150 000

Remarks 1. For four-row cylindrical roller bearings not listed above, please contact NSK.
2. Four-row cylindrical roller bearings are designed for specific applications, when using them, please contact NSK.

Bearing Numbers	Mass (kg)	Figures	Reference Bearing Numbers
	approx.		
370 RV 5401	311	1	—
380 RV 5401	280	1 ⁽¹⁾	—
390 RV 5521	303	2 ⁽¹⁾	—
400 RV 5611	315	3	313015
430 RV 5921	347	2	—
440 RV 6221	430	2	—
450 RV 6321	440	2	—
460 RV 6721	596	2 ⁽¹⁾	—
480 RV 6811	610	3	—
500 RV 6921	580	2 ⁽¹⁾	—
500 RV 7021	622	2 ⁽¹⁾	—
500 RV 7211	782	3	—
520 RV 7331	750	4	—
530 RV 7811	960	3	—
570 RV 8111	960	3	—
610 RV 8711	1 330	3	—
650 RV 9211	1 520	3	—
690 RV 9831	1 790	4	—
700 RV 9311	1 200	3	—
700 RV 9821	1 720	2 ⁽¹⁾	—
725 RV 1011	1 670	3	—
760 RV 1032	2 430	4	—
800 RV 1032	2 050	4	—
820 RV 1121	2 900	2 ⁽¹⁾	—
820 RV 1132	2 000	4	—
850 RV 1111	2 850	3	—
860 RV 1132	1 780	4	—
860 RV 1133	2 200	4	—
900 RV 1211	3 200	3	—
920 RV 1211	3 510	3	—

Note ⁽¹⁾ Oil holes and oil grooves are provided at the center of outer rings.

Railway Rolling Stock Bearings

Railway rolling stock bearings are important components of rolling stocks that require high reliability.

The main bearings consist of axle bearings that are mounted at both ends of axle and support the entire weight of the rolling stock. Additionally, there are railway traction motor bearings that are used for the motor that drives the axle; and gear unit bearings that transfer the power from the motor to the axle. NSK has designed and manufactured specific bearings for these very applications.

Types and Features

Axle Bearings

- Axle bearings consist of the following types of bearings to meet operator demands for high-speed capability of rolling stock, weight reductions, and minimal maintenance and inspection requirements:
 - Cylindrical roller bearings with a thrust collar (oil bath lubrication, grease lubrication)
 - Tapered roller bearings (oil bath lubrication)
 - Sealed-clean rotating end cap cylindrical roller bearings (grease lubrication)
 - Sealed-clean rotating end cap tapered roller bearings (grease lubrication)
- NSK has been approved by AAR (Association of American Railroads).

Traction Motor Bearings

- Bearings for inverter controlled AC motors are specially designed to meet high-speed specifications and requirements for ensuring dimensional stability. NSK recommends long-life grease for these bearings.
- NSK offers the following bearings as a measure against electric erosion, which occurs when electric current is allowed to flow through the motor bearings:
 - Ceramic-insulated bearings (ceramic-coated bearings) and PPS-insulated bearings
- High capacity bearings also available for locomotive-type large traction motors

Gear Unit Bearings

- These bearings are designed to meet high-speed specifications and offer excellent seizure resistance.
- A reinforced cage has been adopted for these bearings.

Specified catalogs

- Bearings for Railway Rolling Stock CAT. No. E1156
- Axle Bearings for Railway Rolling Stock (Cylindrical Roller Bearings) CAT. No. E1239
- Axle Bearings for Railway Rolling Stock (Spherical Roller Bearings) CAT. No. E1240
- Bearings for Traction Motors CAT. No. E1241

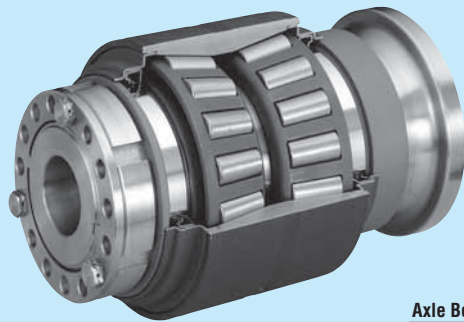

Axle Bearings

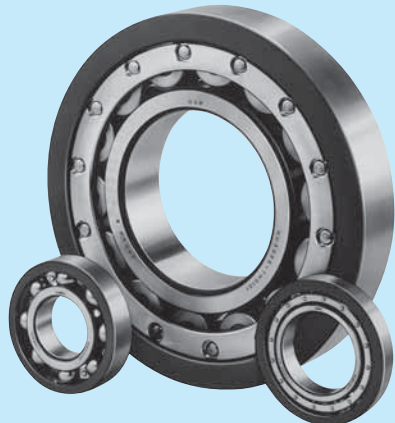
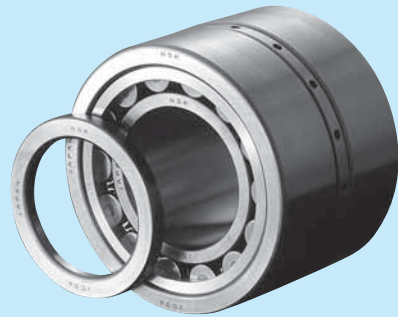

Traction Motor Bearings



Gear Unit Bearings

STEEL BALLS AND ROLLERS

STEEL BALLS FOR BALL BEARINGS	Nominal Diameter 0.3 – 114.3mm.....	B348
CYLINDRICAL ROLLERS FOR ROLLER BEARINGS	Nominal Diameter 3 – 80mm.....	B350
LONG CYLINDRICAL ROLLERS FOR ROLLER BEARINGS	Nominal Diameter 5.5 – 15mm.....	B352
NEEDLE ROLLERS FOR ROLLER BEARINGS	Nominal Diameter 1 – 5mm.....	B354

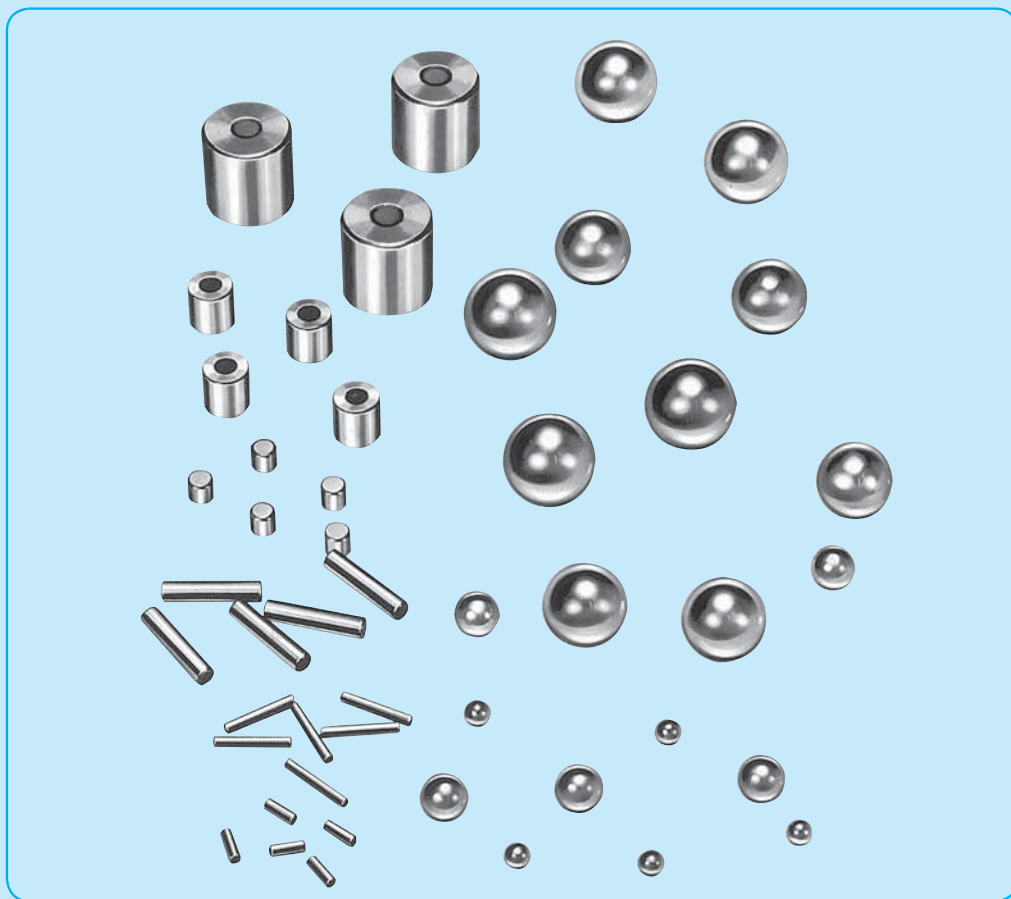

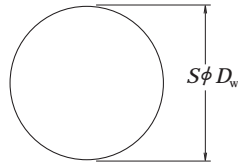

Nominal Size, Basic Diameters, and Mass

Nominal Size	Basic Diameter Dw (mm)	Mass (kg) per 10000 pcs approx.	Nominal Size	Basic Diameter Dw (mm)	Mass (kg) per 1000 pcs approx.	Nominal Size	Basic Diameter Dw (mm)	Mass (kg) per 10 pcs approx.
0.3 mm	0.30000	0.0011	10 mm	9.52500	3.523	30 mm	30.00000	1.101
0.4 mm	0.40000	0.0026		10.00000	4.076	1 3/16	30.16250	1.119
0.5 mm	0.50000	0.0051		10.31875	4.479	1 1/4	31.75000	1.305
0.6 mm	0.60000	0.0088	11 mm	11.00000	5.425	32 mm	32.00000	1.336
0.635 mm	0.63500	0.0104		11.11250	5.594	1 5/16	33.33750	1.510
0.7 mm	0.70000	0.0140	11.5 mm	11.50000	6.199	34 mm	34.00000	1.602
1/32	0.79375	0.0204	12 mm	11.90625	6.880	1 3/8	34.92500	1.736
0.8 mm	0.80000	0.0209		12.00000	7.044	35 mm	35.00000	1.748
1 mm	1.00000	0.0408	1/2	12.70000	8.350	36 mm	36.00000	1.902
3/64	1.19062	0.0688	13 mm	13.00000	8.955	1 7/16	36.51250	1.984
1.2 mm	1.20000	0.0704		13.49375	10.02	38 mm	38.00000	2.237
1.5 mm	1.50000	0.1376	14 mm	14.00000	11.19	1 1/2	38.10000	2.254
1/16	1.58750	0.1631	15 mm	14.28750	11.89	1 9/16	39.68750	2.548
5/64	1.98438	0.3185		15.00000	13.76	40 mm	40.00000	2.609
2 mm	2.00000	0.3261	19/32	15.08125	13.98	1 5/8	41.27500	2.866
3/32	2.38125	0.5504	16 mm	15.87500	16.31	1 11/16	42.86250	3.210
2.5 mm	2.50000	0.6369		16.00000	16.70	1 3/4	44.45000	3.580
7/64	2.77812	0.8740	21/32	16.66875	18.88	45 mm	45.00000	3.714
3 mm	3.00000	1.101	17 mm	17.00000	20.03	1 13/16	46.03750	3.977
1/8	3.17500	1.305		17.46250	21.71	1 7/8	47.62500	4.403
3.5 mm	3.50000	1.748	18 mm	18.00000	23.77	1 15/16	49.21250	4.858
9/64	3.57188	1.858	19 mm	18.25625	24.80	50 mm	50.00000	5.095
5/32	3.96875	2.548		19.00000	27.96	2	50.80000	5.344
4 mm	4.00000	2.609	3/4	19.05000	28.18	2 1/8	53.97500	6.410
4.5 mm	4.50000	3.714	20 mm	19.84375	31.85	55 mm	55.00000	6.782
3/16	4.76250	4.403		20.00000	32.61	2 1/4	57.15000	7.609
5 mm	5.00000	5.095	13/16	20.63750	35.83	60 mm	60.00000	8.805
5.5 mm	5.50000	6.782	21 mm	21.00000	37.75	2 3/8	60.32500	8.948
7/32	5.55625	7.016		21.43125	40.12	2 1/2	63.50000	10.44
15/64	5.95312	8.600	22 mm	22.00000	43.40	65 mm	65.00000	11.19
6 mm	6.00000	8.805	23 mm	22.22500	44.75	2 5/8	66.67500	12.08
1/4	6.35000	10.44		23.00000	49.60	2 3/4	69.85000	13.89
6.5 mm	6.50000	11.19	29/32	23.01875	49.72	2 7/8	73.02500	15.87
17/64	6.74688	12.52	24 mm	23.81250	55.04	3	76.20000	18.04
7 mm	7.00000	13.98		24.00000	56.35	3 1/4	82.55000	22.93
9/32	7.14375	14.86	31/32	24.60625	60.73	3 1/2	88.90000	28.64
7.5 mm	7.50000	17.20	25 mm	25.00000	63.69	3 3/4	95.25000	35.23
5/16	7.93750	20.38		25.40000	66.80	4	101.60000	42.75
8 mm	8.00000	20.87	26 mm	26.00000	71.64			
8.5 mm	8.50000	25.03	28 mm	26.98750	80.12			
11/32	8.73125	27.13		28.00000	89.48			
9 mm	9.00000	29.72	1 1/8	28.57500	95.11			

B 348 Remarks A column blue letter of Nominal Size is corresponding inch dimensions (reference).

Application, Nominal Size, Tolerances, Roughness, and Gauges

Units : μm

Class	Tolerances ⁽¹⁾			Gauges		
	Variation in Dia. max.	Sphericity max.	Roughness Ra max.	Diameter Difference per Lot max.	Gauge Interval	Gauge
G 3	0.08	0.08	0.010	0.13	0.5	- 5,, - 0.5, 0, + 0.5,, + 5
G 5	0.13	0.13	0.014	0.25	1	- 5,, - 1, 0, + 1,, + 5
G 10	0.25	0.25	0.020	0.5	1	- 9,, - 1, 0, + 1,, + 9
G 16	0.4	0.4	0.025	0.8	2	-10,, - 2, 0, + 2,, +10
G 20	0.5	0.5	0.032	1	2	-10,, - 2, 0, + 2,, +10
G 24	0.6	0.6	0.040	1.2	2	-12,, - 2, 0, + 2,, +12
G 28	0.7	0.7	0.050	1.4	2	-12,, - 2, 0, + 2,, +12
G 40	1	1	0.060	2	4	-16,, - 4, 0, + 4,, +16
G 60	1.5	1.5	0.080	3	6	-18,, - 6, 0, + 6,, +18
G100	2.5	2.5	0.100	5	10	-40,, -10, 0, +10,, +40
G200	5	5	0.150	10	15	-60,, -15, 0, +15,, +60

Note ⁽¹⁾ The values do not take into account surface defects; hence measurement shall be taken outside such defects.

Hardness

Nominal Size	Hardness	
	HV	HRC
0.3 mm ~ 3 mm	772-900	(63-67) ⁽¹⁾
1/8 ~ 30 mm	—	62-67
1 3/16 ~ 4	—	61-67

Note ⁽¹⁾ Values in () are converted values for reference.
Remarks A column blue letter of Nominal Size is inch dimensions.

Tolerances for Cylindrical Roller Chamfers

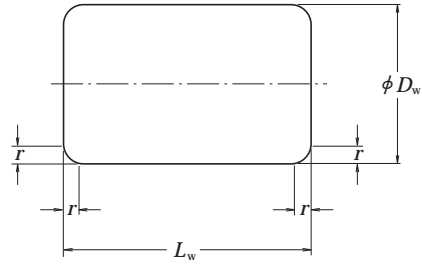

Units : mm

min.	max.
0.1	0.3
0.2	0.5
0.3	0.8
0.5	1.2
0.6	1.5
0.7	1.7
1	2.2 ⁽¹⁾
1.5	3.5
2	4

Note ⁽¹⁾ If D_w exceeds 40 mm, r (max.) is 2.7 mm.

Units : mm

Nominal Size	D_w	L_w	r min.	Mass (kg) per 100 pcs approx.
3 × 3	3	3	0.1	0.016
3 × 5	3	5	0.1	0.027
3.5 × 5	3.5	5	0.2	0.037
4 × 4	4	4	0.2	0.039
4 × 6	4	6	0.2	0.058
4 × 8	4	8	0.2	0.078
4.5 × 4.5	4.5	4.5	0.2	0.055
4.5 × 6	4.5	6	0.2	0.073
5 × 5	5	5	0.2	0.075
5 × 8	5	8	0.2	0.121
5 × 10	5	10	0.2	0.152
5.5 × 5.5	5.5	5.5	0.2	0.10
5.5 × 8	5.5	8	0.2	0.146
6 × 6	6	6	0.2	0.13
6 × 8	6	8	0.2	0.178
6 × 12	6	12	0.2	0.261
6.5 × 6.5	6.5	6.5	0.3	0.166
6.5 × 9	6.5	9	0.3	0.23
7 × 7	7	7	0.3	0.206
7 × 10	7	10	0.3	0.296
7 × 14	7	14	0.3	0.415
7.5 × 7.5	7.5	7.5	0.3	0.254
7.5 × 11	7.5	11	0.3	0.375
8 × 8	8	8	0.3	0.31
8 × 12	8	12	0.3	0.465
9 × 9	9	9	0.3	0.44
9 × 14	9	14	0.3	0.68
10 × 10	10	10	0.3	0.60
10 × 14	10	14	0.3	0.85
11 × 11	11	11	0.3	0.81
11 × 15	11	15	0.3	1.1
12 × 12	12	12	0.3	1.04
12 × 18	12	18	0.3	1.57
13 × 13	13	13	0.3	1.33
13 × 20	13	20	0.3	2.04
14 × 14	14	14	0.3	1.66
14 × 20	14	20	0.3	2.38

Units : mm

Nominal Size	D_w	L_w	r min.	Mass (kg) per 100 pcs approx.
15 × 15	15	15	0.5	2.04
15 × 22	15	22	0.5	3.0
16 × 16	16	16	0.5	2.48
16 × 24	16	24	0.5	3.75
17 × 17	17	17	0.5	2.97
17 × 24	17	24	0.5	4.2
18 × 18	18	18	0.5	3.55
18 × 26	18	26	0.5	5.1
19 × 19	19	19	0.6	4.16
19 × 28	19	28	0.6	6.1
20 × 20	20	20	0.6	4.85
20 × 30	20	30	0.6	7.3
21 × 21	21	21	0.6	5.6
21 × 30	21	30	0.6	8.0
22 × 22	22	22	0.6	6.4
22 × 34	22	34	0.6	10
23 × 23	23	23	0.6	7.4
23 × 34	23	34	0.6	11.2
24 × 24	24	24	0.6	8.4
24 × 36	24	36	0.6	12.6
25 × 25	25	25	0.7	9.5
25 × 36	25	36	0.7	13.7
26 × 26	26	26	0.7	10.7
26 × 40	26	40	0.7	16.4
28 × 28	28	28	0.7	13.3
28 × 44	28	44	0.7	21
30 × 30	30	30	0.7	16.3
30 × 48	30	48	0.7	26.2
32 × 32	32	32	1	19.9
32 × 52	32	52	1	32.5
34 × 34	34	34	1	23.9
34 × 55	34	55	1	38.5
36 × 36	36	36	1	28.3
36 × 58	36	58	1	45.5
38 × 38	38	38	1	33.5
38 × 62	38	62	1	55
40 × 40	40	40	1	39
40 × 65	40	65	1	63

Units : mm

Nominal Size	D_w	L_w	r min.	Mass (kg) per 100 pcs approx.
42 × 42	42	42	1	45
45 × 45	45	45	1	55.5
48 × 48	48	48	1	67
50 × 50	50	50	1	76
52 × 52	52	52	1.5	85
54 × 54	54	54	1.5	95.5
56 × 56	56	56	1.5	107
60 × 60	60	60	1.5	131
64 × 64	64	64	1.5	159
68 × 68	68	68	1.5	191
75 × 75	75	75	2	256
80 × 80	80	80	2	310

Accuracy of Cylindrical Rollers

Units : μm

Class	D_w (mm)		Out-of-Roundness ⁽¹⁾ ΔR max.	Single Plane Mean Roller Diameter Variation ⁽²⁾ VD_{Wmp} max.	Roller Gauge Lot Diameter Variation ⁽¹⁾ VD_{WL} max.	Length Deviation ⁽³⁾ ΔL_{Ws}		Roller Gauge Lot Length Variation VL_{WL} max.	End Face Runout S_w max.
	over	incl.				high	low ⁽⁴⁾		
1	3	18	0.5	0.8	1	+10	- [(IT9) - 10]	5	3
1A	3	30	0.7	1	1.5	+10	- [(IT9) - 10]	7	5
2	3	50	1	1.5	2	+10	- [(IT9) - 10]	10	6
2A	10	80	1.3	2	2.5	+10	- [(IT9) - 10]	13	8
3	18	80	1.5	3	3	+10	- [(IT9) - 10]	15	10
5	30	80	2.5	4	5	+10	- [(IT9) - 10]	25	15

Notes ⁽¹⁾ Applicable to roller center (length direction).

⁽²⁾ Applicable to cylindrical outside surface.

⁽³⁾ To find the IT9 standard tolerance according to the L_w size classification, refer to the IT9 column of the Appendix Table 11 on Page C22.

⁽⁴⁾ The value for low of length deviation is subtracted 10 μm from the value of the standard tolerance for each roller length.

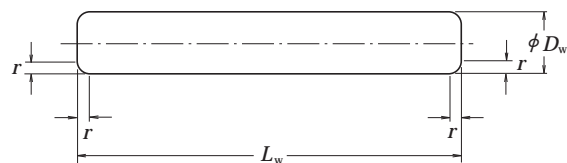

Remarks The figure shows an example of a flat-end long cylindrical roller.

Units : mm					Units : mm				
Nominal Size	D_w	L_w	$r^{(1)}$ min.	Mass (kg) per 100 pcs approx.	Nominal Size	D_w	L_w	$r^{(1)}$ min.	Mass (kg) per 100 pcs approx.
5.5×18	5.5	18	0.2	0.333	8 ×25	8	25	0.3	0.978
5.5×22.4	5.5	22.4	0.2	0.414	8 ×31.5	8	31.5	0.3	1.23
5.5×28	5.5	28	0.2	0.518	8 ×40	8	40	0.3	1.56
6 ×20	6	20	0.2	0.44	8 ×50	8	50	0.3	1.96
6 ×25	6	25	0.2	0.55	8 ×63	8	63	0.3	2.46
6 ×31.5	6	31.5	0.2	0.693	9 ×28	9	28	0.3	1.39
6 ×40	6	40	0.2	0.88	9 ×35.5	9	35.5	0.3	1.76
6 ×50	6	50	0.2	1.1	9 ×45	9	45	0.3	2.23
6.5×20	6.5	20	0.3	0.516	9 ×56	9	56	0.3	2.77
6.5×25	6.5	25	0.3	0.645	10×31.5	10	31.5	0.3	1.93
6.5×31.5	6.5	31.5	0.3	0.813	10×40	10	40	0.3	2.44
7 ×22.4	7	22.4	0.3	0.671	10×50	10	50	0.3	3.06
7 ×28	7	28	0.3	0.838	10×63	10	63	0.3	3.85
7 ×35.5	7	35.5	0.3	1.06	12×40	12	40	0.3	3.52
7 ×45	7	45	0.3	1.35	12×50	12	50	0.3	4.4
7 ×56	7	56	0.3	1.68	12×63	12	63	0.3	5.54
7.5×31.5	7.5	31.5	0.3	1.08	15×45	15	45	0.5	6.16
7.5×40	7.5	40	0.3	1.38	15×56	15	56	0.5	7.68
					15×71	15	71	0.5	9.74
					15×90	15	90	0.5	12.4

Note (1) Only for flat-end rollers.

Tolerances for Long Cylindrical Roller Chamfers

Units : mm	
min.	max.
0.2	0.5
0.3	0.8
0.5	1.2

Accuracy of Long Cylindrical Rollers

Units : μm				
Class	Out-of-Roundness (1) ΔR max.	Single Plane Mean Roller Diameter Variation (3) VD_{Wmp} max.	Roller Gauge Lot Diameter Variation (1) VD_{WL} max.	Length Deviation (2) ΔL_{Ws}
3	1.5	3	3	h12
5	2	5	5	h12

Notes (1) Applicable to roller center (length direction).
 (2) Classified by L_w . Refer to Tolerance for Length Deviation.
 (3) Applicable to cylindrical outside surface.

Tolerance for Length Deviation

Length		Units : mm			
over	incl.	h12		h13	
		high	low	high	low
3	6	—	—	0	-0.18
6	10	—	—	0	-0.22
10	18	—	—	0	-0.27
18	30	0	-0.21	0	-0.33
30	50	0	-0.25	0	-0.39
50	80	0	-0.30	—	—
80	120	0	-0.35	—	—

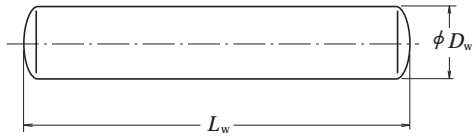

Spherical-end Type



Flat-end Type

Units : mm

Nominal Size	D_w	L_w	r ⁽¹⁾ min.	Mass (kg) per 1000 pcs approx.
1 × 5.8	1	5.8	0.1	0.035
1 × 6.8	1	6.8	0.1	0.042
1 × 7.8	1	7.8	0.1	0.048
1 × 9.8	1	9.8	0.1	0.060
1.5 × 5.8	1.5	5.8	0.1	0.080
1.5 × 6.8	1.5	6.8	0.1	0.093
1.5 × 7.8	1.5	7.8	0.1	0.105
1.5 × 9.8	1.5	9.8	0.1	0.135
1.5 × 11.8	1.5	11.8	0.1	0.160
1.5 × 13.8	1.5	13.8	0.1	0.190
2 × 6.8	2	6.8	0.1	0.165
2 × 7.8	2	7.8	0.1	0.190
2 × 9.8	2	9.8	0.1	0.240
2 × 11.8	2	11.8	0.1	0.290
2 × 13.8	2	13.8	0.1	0.335
2 × 15.8	2	15.8	0.1	0.385
2 × 17.8	2	17.8	0.1	0.435
2 × 19.8	2	19.8	0.1	0.485
2.5 × 7.8	2.5	7.8	0.1	0.300
2.5 × 9.8	2.5	9.8	0.1	0.375
2.5 × 11.8	2.5	11.8	0.1	0.450
2.5 × 13.8	2.5	13.8	0.1	0.525
2.5 × 15.8	2.5	15.8	0.1	0.605
2.5 × 17.8	2.5	17.8	0.1	0.680
2.5 × 19.8	2.5	19.8	0.1	0.755
2.5 × 21.8	2.5	21.8	0.1	0.835
2.5 × 23.8	2.5	23.8	0.1	0.910
3 × 9.8	3	9.8	0.1	0.540
3 × 11.8	3	11.8	0.1	0.650
3 × 13.8	3	13.8	0.1	0.760
3 × 15.8	3	15.8	0.1	0.870
3 × 17.8	3	17.8	0.1	0.980
3 × 19.8	3	19.8	0.1	1.10
3 × 21.8	3	21.8	0.1	1.20
3 × 23.8	3	23.8	0.1	1.30
3 × 25.8	3	25.8	0.1	1.40
3 × 27.8	3	27.8	0.1	1.55
3 × 29.8	3	29.8	0.1	1.65
3.5 × 11.8	3.5	11.8	0.1	0.885
3.5 × 13.8	3.5	13.8	0.1	1.05
3.5 × 15.8	3.5	15.8	0.1	1.20
3.5 × 17.8	3.5	17.8	0.1	1.35

Units : mm

Nominal Size	D_w	L_w	r ⁽¹⁾ min.	Mass (kg) per 1000 pcs approx.
3.5 × 19.8	3.5	19.8	0.1	1.50
3.5 × 21.8	3.5	21.8	0.1	1.65
3.5 × 23.8	3.5	23.8	0.1	1.80
3.5 × 25.8	3.5	25.8	0.1	1.95
3.5 × 27.8	3.5	27.8	0.1	2.10
3.5 × 29.8	3.5	29.8	0.1	2.25
3.5 × 31.8	3.5	31.8	0.1	2.40
3.5 × 34.8	3.5	34.8	0.1	2.60
4 × 13.8	4	13.8	0.1	1.35
4 × 15.8	4	15.8	0.1	1.55
4 × 17.8	4	17.8	0.1	1.75
4 × 19.8	4	19.8	0.1	1.95
4 × 21.8	4	21.8	0.1	2.15
4 × 23.8	4	23.8	0.1	2.35
4 × 25.8	4	25.8	0.1	2.55
4 × 27.8	4	27.8	0.1	2.70
4 × 29.8	4	29.8	0.1	2.90
4 × 31.8	4	31.8	0.1	3.10
4 × 34.8	4	34.8	0.1	3.40
4 × 37.8	4	37.8	0.1	3.70
4 × 39.8	4	39.8	0.1	3.90
4.5 × 17.8	4.5	17.8	0.1	2.20
4.5 × 19.8	4.5	19.8	0.1	2.45
4.5 × 21.8	4.5	21.8	0.1	2.70
4.5 × 23.8	4.5	23.8	0.1	2.95
4.5 × 25.8	4.5	25.8	0.1	3.20
4.5 × 29.8	4.5	29.8	0.1	3.70
4.5 × 31.8	4.5	31.8	0.1	3.95
4.5 × 34.8	4.5	34.8	0.1	4.30
4.5 × 37.8	4.5	37.8	0.1	4.70
4.5 × 39.8	4.5	39.8	0.1	4.90
5 × 19.8	5	19.8	0.1	3.00
5 × 21.8	5	21.8	0.1	3.35
5 × 23.8	5	23.8	0.1	3.65
5 × 25.8	5	25.8	0.1	3.95
5 × 27.8	5	27.8	0.1	4.25
5 × 29.8	5	29.8	0.1	4.55
5 × 31.8	5	31.8	0.1	4.85
5 × 34.8	5	34.8	0.1	5.30
5 × 37.8	5	37.8	0.1	5.75
5 × 39.8	5	39.8	0.1	6.10
5 × 49.8	5	49.8	0.1	7.60

Tolerances for Needle Roller Chamfers

Units : mm

D_w		r min.	r max.
over	incl.		
—	1	0.1	0.4
1	3	0.1	0.6
3	5	0.1	0.9

Remarks Only for flat-end needle rollers.

Accuracy of Needle Rollers

Units : μm

Class	Single Plane Mean Roller Diameter Variation ⁽¹⁾ VD_{WP} max.	Out-of-Roundness ⁽¹⁾ ΔR max.	Roller Gauge Lot Diameter Variation ⁽¹⁾ VD_{WL} max.	Length Deviation ⁽²⁾ ΔL_{W5}
2	1	1	2	h13
3	1.5	1.5	3	h13
5	2	2.5	5	h13

Notes ⁽¹⁾ Applicable to roller center (length direction).

⁽²⁾ Classified by L_w . Refer to Tolerance for Length Deviation in Page B353.

Remarks The actual diameter at any place along the entire length should not exceed the following figures compared to the actual maximum diameter at the roller center (length direction).

- Class2: 0.5 μm
- Class3: 0.8 μm
- Class5: 1.0 μm

Note ⁽¹⁾ Only for flat-end rollers.

Remarks 1. The figure shows a spherical-end type and a flat-end type.

2. The radius R of the spherical-end type is bounded by the following range:

Minimum: $D_w/2$

Maximum: $L_w/2$

ACCESSORIES FOR ROLLING BEARINGS

ADAPTERS FOR ROLLING BEARINGS	Shaft Diameter 17 – 470mm.....	B358
WITHDRAWAL SLEEVES FOR ROLLING BEARINGS	Shaft Diameter 35 – 480mm.....	B366
NUTS FOR ROLLING BEARINGS	B372
STOPPERS FOR ROLLING BEARINGS	B377
LOCK-WASHERS FOR ROLLING BEARINGS	B378

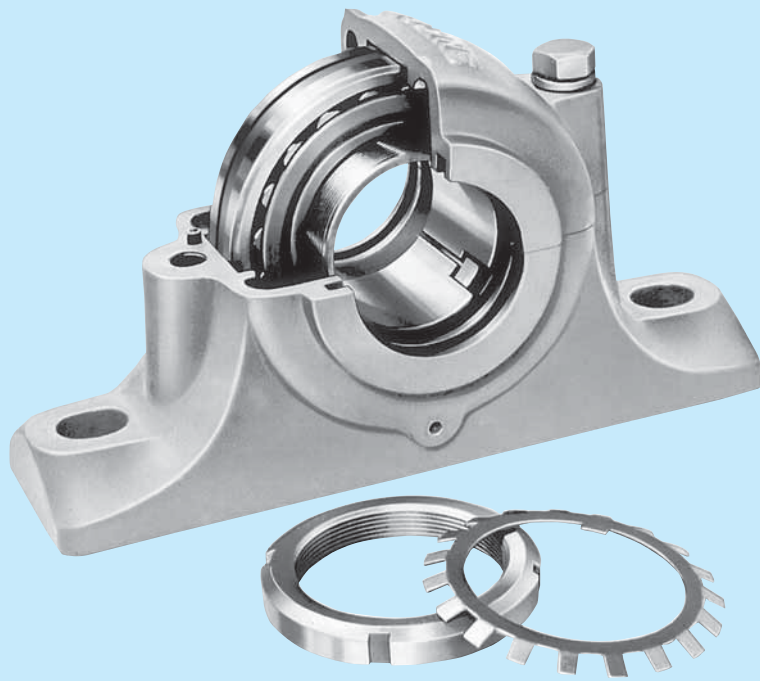

Shaft Diameter 17 – 40 mm

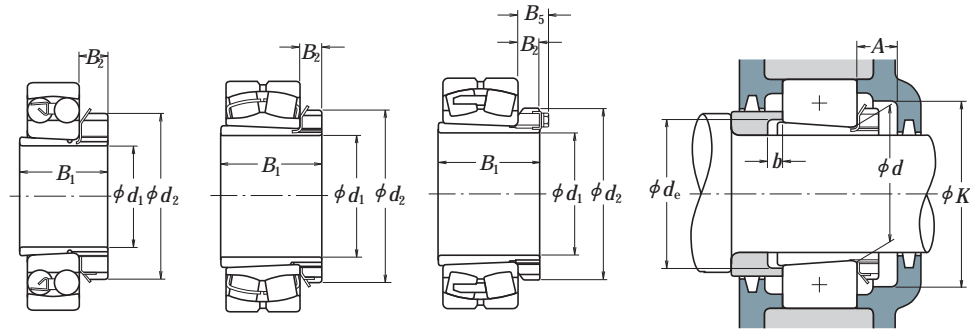

Shaft Diameter 45 – 60 mm

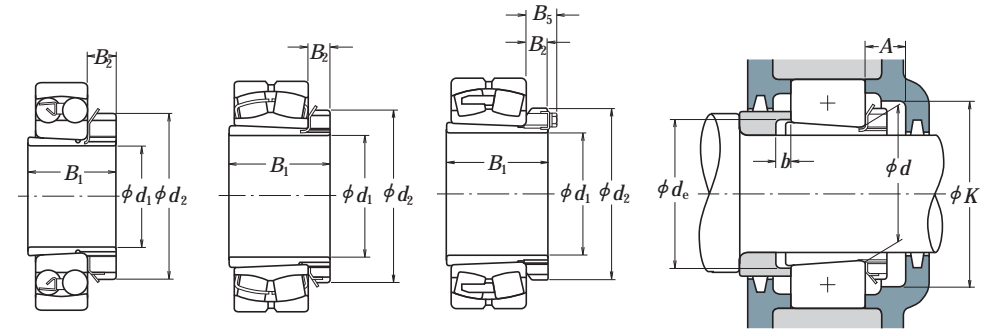

Shaft Diameter (mm) d_1	Nominal Bearing Bore Dia. (mm) d	Nominal Numbers Applicable Bearings		Dimensions (mm)				Adapter Sleeve Numbers	Abutment Dimensions (mm)				Mass (kg) approx.
				B_1	d_2	B_2	B_3		A min.	K min.	d_e min.	b min.	
17	20	1204K	+ H 204X	24	32	7	—	A 204X	14	39	23	5	0.045
	20	2204K	+ H 304X	28	32	7	—	A 304X	14	39	24	5	0.045
	20	1304K	+ H 304X	28	32	7	—	A 304X	14	39	24	8	0.045
	20	2304K	+ H2304X	31	32	7	—	A2304X	14	39	24	5	0.050
20	25	1205K	+ H 205X	26	38	8	—	A 205X	15	45	28	5	0.065
	25	2205K	+ H 305X	29	38	8	—	A 305X	15	45	29	5	0.075
	25	1305K	+ H 305X	29	38	8	—	A 305X	15	45	29	6	0.075
	25	21305C DKE4	+ H 305X	29	38	8	—	A 305X	15	45	29	6	0.075
25	2305K	+ H2305X	35	38	8	—	A2305X	15	45	29	5	0.090	
25	30	1206K	+ H 206X	27	45	8	—	A 206X	15	50	33	5	0.10
	30	2206K	+ H 306X	31	45	8	—	A 306X	15	50	34	5	0.11
	30	1306K	+ H 306X	31	45	8	—	A 306X	15	50	34	6	0.11
	30	21306C DKE4	+ H 306X	31	45	8	—	A 306X	15	50	34	6	0.11
30	2306K	+ H2306X	38	45	8	—	A2306X	15	50	35	5	0.125	
30	35	1207K	+ H 207X	29	52	9	—	A 207X	17	58	38	5	0.125
	35	2207K	+ H 307X	35	52	9	—	A 307X	17	58	39	5	0.145
	35	1307K	+ H 307X	35	52	9	—	A 307X	17	58	39	7	0.145
	35	21307C DKE4	+ H 307X	35	52	9	—	A 307X	17	58	39	7	0.145
35	2307K	+ H2307X	43	52	9	—	A2307X	17	58	40	5	0.16	
35	40	1208K	+ H 208X	31	58	10	—	A 208X	17	65	44	5	0.175
	40	2208K	+ H 308X	36	58	10	—	A 308X	17	65	44	5	0.19
	40	1308K	+ H 308X	36	58	10	—	A 308X	17	65	44	5	0.19
	40	21308E AKE4	+ H 308X	36	58	10	—	A 308X	17	65	44	5	0.19
40	2308K	+ H2308X	46	58	10	—	A2308X	17	65	45	5	0.225	
40	22308E AKE4	+ H2308X	46	58	10	—	A2308X	17	65	45	5	0.225	
40	45	1209K	+ H 209X	33	65	11	—	A 209X	17	72	49	5	0.225
	45	2209K	+ H 309X	39	65	11	—	A 309X	17	72	49	8	0.26
	45	1309K	+ H 309X	39	65	11	—	A 309X	17	72	49	5	0.26
	45	21309E AKE4	+ H 309X	39	65	11	—	A 309X	17	72	49	5	0.26
45	2309K	+ H2309X	50	65	11	—	A2309X	17	72	50	5	0.30	
45	22309E AKE4	+ H2309X	50	65	11	—	A2309X	17	72	50	5	0.30	

Remarks The suffix X represents adapter sleeves having narrow slits, for which washers with straight tabs should be used.

Shaft Diameter (mm) d_1	Nominal Bearing Bore Dia. (mm) d	Nominal Numbers Applicable Bearings		Dimensions (mm)				Adapter Sleeve Numbers	Abutment Dimensions (mm)				Mass (kg) approx.
				B_1	d_2	B_2	B_3		A min.	K min.	d_e min.	b min.	
45	50	1210K	+ H 210X	35	70	12	—	A 210X	19	76	53	5	0.275
	50	2210K	+ H 310X	42	70	12	—	A 310X	19	76	54	10	0.30
	50	1310K	+ H 310X	42	70	12	—	A 310X	19	76	54	5	0.30
50	50	21310E AKE4	+ H 310X	42	70	12	—	A 310X	19	76	54	5	0.30
	50	2310K	+ H2310X	55	70	12	—	A2310X	19	76	56	5	0.35
	50	22310E AKE4	+ H2310X	55	70	12	—	A2310X	19	76	56	5	0.35
50	55	1211K	+ H 211X	37	75	12	—	A 211X	19	85	60	6	0.305
	55	2211K	+ H 311X	45	75	12	—	A 311X	19	85	60	11	0.35
	55	22211E AKE4	+ H 311X	45	75	12	—	A 311X	19	85	60	11	0.35
55	55	1311K	+ H 311X	45	75	12	—	A 311X	19	85	60	6	0.35
	55	21311E AKE4	+ H 311X	45	75	12	—	A 311X	19	85	60	6	0.35
	55	2311K	+ H2311X	59	75	12	—	A2311X	19	85	61	6	0.40
	55	22311E AKE4	+ H2311X	59	75	12	—	A2311X	19	85	61	6	0.40
	55	22212E AKE4	+ H 312X	47	80	13	—	A 312X	20	90	65	9	0.40
60	60	1312K	+ H 312X	47	80	13	—	A 312X	20	90	65	5	0.40
	60	21312E AKE4	+ H 312X	47	80	13	—	A 312X	20	90	65	5	0.40
	60	2312K	+ H2312X	62	80	13	—	A2312X	20	90	66	5	0.45
	60	22312E AKE4	+ H2312X	62	80	13	—	A2312X	20	90	66	5	0.45
60	65	1213K	+ H 213X	40	85	14	—	A 213X	21	96	70	5	0.40
	65	2213K	+ H 313X	50	85	14	—	A 313X	21	96	70	8	0.45
	65	22213E AKE4	+ H 313X	50	85	14	—	A 313X	21	96	70	8	0.45
65	65	1313K	+ H 313X	50	85	14	—	A 313X	21	96	70	5	0.45
	65	21313E AKE4	+ H 313X	50	85	14	—	A 313X	21	96	70	5	0.45
	65	2313K	+ H2313X	65	85	14	—	A2313X	21	96	72	5	0.55
	65	22313E AKE4	+ H2313X	65	85	14	—	A2313X	21	96	72	5	0.55
70	70	22214E AKE4	+ H 314X	52	92	14	—	A 314X	21	96	70	8	0.65
	70	21314E AKE4	+ H 314X	52	92	14	—	A 314X	21	96	70	5	0.65
	70	22314E AKE4	+ H2314X	68	92	14	—	A2314X	21	96	72	5	0.80

Remarks The suffix X represents adapter sleeves having narrow slits, for which washers with straight tabs should be used.

Shaft Diameter 65 – 80 mm

Shaft Diameter 85 – 115 mm

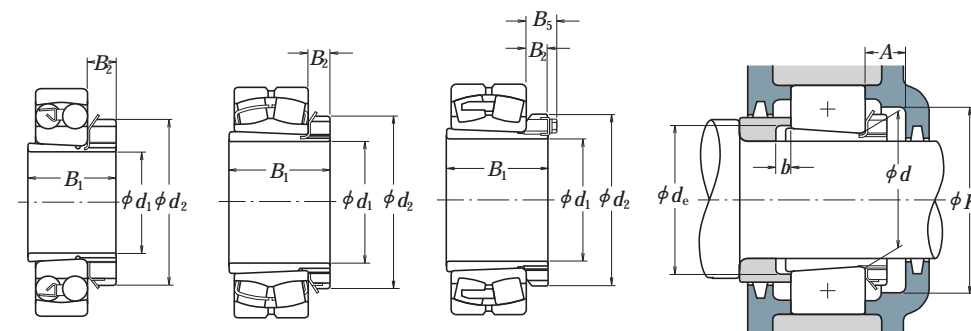
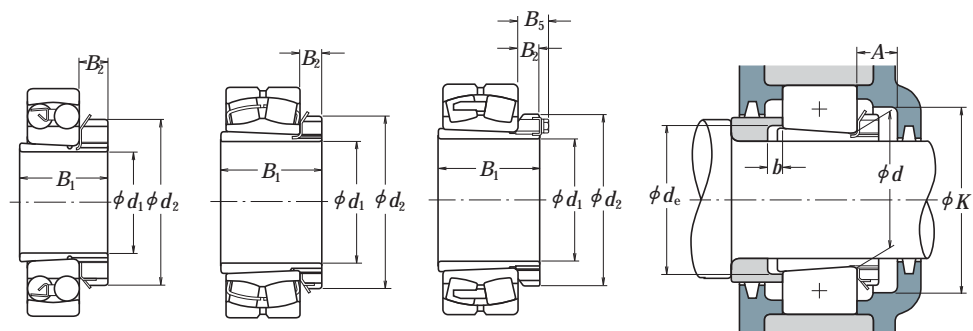

Shaft Diameter (mm) d_1	Nominal Bearing Bore Dia. (mm) d	Nominal Numbers Applicable Bearings	Dimensions (mm)				Adapter Sleeve Numbers	Abutment Dimensions (mm)				Mass (kg) approx.	
			B_1	d_2	B_2	B_3		A min.	K min.	d_e min.	b min.		
65	75	1215K + H 215X	43	98	15	—	A 215X	23	110	80	5	0.70	
	75	2215K + H 315X	55	98	15	—	A 315X	23	110	80	12	0.85	
	75	22215E AKE4 + H 315X	55	98	15	—	A 315X	23	110	80	12	0.85	
	75	1315K + H 315X	55	98	15	—	A 315X	23	110	80	5	0.85	
	75	21315E AKE4 + H 315X	55	98	15	—	A 315X	23	110	80	5	0.85	
	75	2315K + H2315X	73	98	15	—	A2315X	23	110	82	5	1.05	
	75	22315E AKE4 + H2315X	73	98	15	—	A2315X	23	110	82	5	1.05	
	70	80	1216K + H 216X	46	105	17	—	A 216X	25	120	85	5	0.85
		80	2216K + H 316X	59	105	17	—	A 316X	25	120	86	12	1.05
		80	22216E AKE4 + H 316X	59	105	17	—	A 316X	25	120	86	12	1.05
80		1316K + H 316X	59	105	17	—	A 316X	25	120	86	5	1.05	
80		21316E AKE4 + H 316X	59	105	17	—	A 316X	25	120	86	5	1.05	
80		2316K + H2316X	78	105	17	—	A2316X	25	120	87	5	1.3	
80		22316E AKE4 + H2316X	78	105	17	—	A2316X	25	120	87	5	1.3	
75		85	1217K + H 217X	50	110	18	—	A 217X	27	128	90	6	1.0
		85	2217K + H 317X	63	110	18	—	A 317X	27	128	91	12	1.2
		85	22217E AKE4 + H 317X	63	110	18	—	A 317X	27	128	91	12	1.2
	85	1317K + H 317X	63	110	18	—	A 317X	27	128	91	6	1.2	
	85	21317E AKE4 + H 317X	63	110	18	—	A 317X	27	128	91	6	1.2	
	85	2317K + H2317X	82	110	18	—	A2317X	27	128	94	6	1.45	
	85	22317E AKE4 + H2317X	82	110	18	—	A2317X	27	128	94	6	1.45	
	80	90	1218K + H 218X	52	120	18	—	A 218X	28	139	95	6	1.15
		90	2218K + H 318X	65	120	18	—	A 318X	28	139	96	10	1.4
		90	22218E AKE4 + H 318X	65	120	18	—	A 318X	28	139	96	10	1.4
90		1318K + H 318X	65	120	18	—	A 318X	28	139	96	6	1.4	
90		21318E AKE4 + H 318X	65	120	18	—	A 318X	28	139	96	6	1.4	
90		2318K + H2318X	86	120	18	—	A2318X	28	139	99	6	1.7	
90		23218C KE4 + H2318X	86	120	18	—	A2318X	28	139	99	6	1.7	
90		22318E AKE4 + H2318X	86	120	18	—	A2318X	28	139	99	6	1.7	

Remarks The suffix X represents adapter sleeves having narrow slits, for which washers with straight tabs should be used.

Shaft Diameter (mm) d_1	Nominal Bearing Bore Dia. (mm) d	Nominal Numbers Applicable Bearings	Dimensions (mm)				Adapter Sleeve Numbers	Abutment Dimensions (mm)				Mass (kg) approx.	
			B_1	d_2	B_2	B_3		A min.	K min.	d_e min.	b min.		
85	95	1219K + H 219X	55	125	19	—	A 219X	29	145	101	7	1.35	
	95	2219K + H 319X	68	125	19	—	A 319X	29	145	102	9	1.55	
	95	22219E AKE4 + H 319X	68	125	19	—	A 319X	29	145	102	9	1.55	
	95	1319K + H 319X	68	125	19	—	A 319X	29	145	102	7	1.55	
	95	21319C KE4 + H 319X	68	125	19	—	A 319X	29	145	102	7	1.55	
	95	2319K + H2319X	90	125	19	—	A2319X	29	145	105	7	1.9	
	95	22319E AKE4 + H2319X	90	125	19	—	A2319X	29	145	105	7	1.9	
	90	100	1220K + H 220X	58	130	20	—	A 220X	30	150	106	7	1.45
		100	2220K + H 320X	71	130	20	—	A 320X	30	150	107	8	1.7
		100	22220E AKE4 + H 320X	71	130	20	—	A 320X	30	150	107	8	1.7
100		1320K + H 320X	71	130	20	—	A 320X	30	150	107	7	1.7	
100		21320C KE4 + H 320X	71	130	20	—	A 320X	30	150	107	7	1.7	
100		2320K + H2320X	97	130	20	—	A2320X	30	150	110	7	2.15	
100		23220C KE4 + H2320X	97	130	20	—	A2320X	30	150	110	7	2.15	
100		22320E AKE4 + H2320X	97	130	20	—	A2320X	30	150	110	7	2.15	
100		110	23122C KE4 + H3122X	81	145	21	—	A3122X	32	170	117	7	2.25
		110	1222K + H 222X	63	145	21	—	A 222X	32	170	116	7	1.95
	110	2222K + H 322X	77	145	21	—	A 322X	32	170	117	6	2.3	
	110	22222E AKE4 + H 322X	77	145	21	—	A 322X	32	170	117	6	2.3	
	110	1322K + H 322X	77	145	21	—	A 322X	32	170	117	9	2.3	
	110	2322K + H2322X	105	145	21	—	A2322X	32	170	121	7	2.75	
	110	23222C KE4 + H2322X	105	145	21	—	A2322X	32	170	121	7	2.75	
	110	23222E AKE4 + H2322X	105	145	21	—	A2322X	32	170	121	7	2.75	
	110	120	23024C DKE4 + H3024	72	145	22	—	A 3024	33	180	127	7	1.95
		120	23124C KE4 + H3124	88	155	22	—	A 3124	33	180	128	7	2.65
120		22224E AKE4 + H3124	88	155	22	—	A 3124	33	180	128	11	2.65	
120		23224C KE4 + H2324	112	155	22	—	A 2324	33	180	131	17	3.2	
120		22324E AKE4 + H2324	112	155	22	—	A 2324	33	180	131	7	3.2	
115		130	23026C DKE4 + H3026	80	155	23	—	A 3026	34	190	137	8	2.85
		130	23126C KE4 + H3126	92	165	23	—	A 3126	34	190	138	8	3.65
		130	22226E AKE4 + H3126	92	165	23	—	A 3126	34	190	138	8	3.65
		130	23226C KE4 + H2326	121	165	23	—	A 2326	34	190	142	21	4.6
		130	22326C KE4 + H2326	121	165	23	—	A 2326	34	190	142	8	4.6

Remarks The suffix X represents adapter sleeves having narrow slits, for which washers with straight tabs should be used.

Shaft Diameter 125 – 170 mm

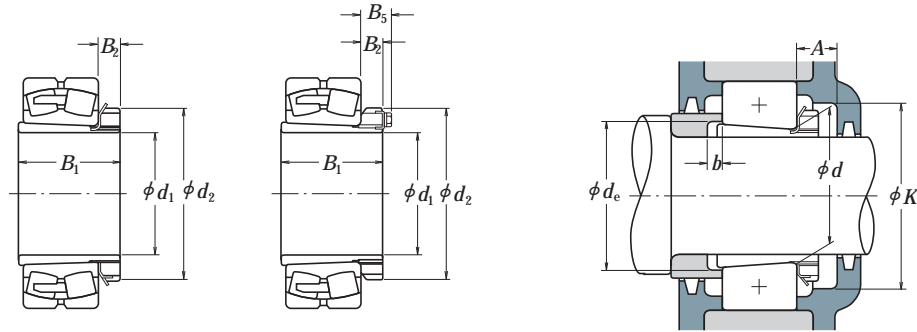

Shaft Diameter 180 – 260 mm

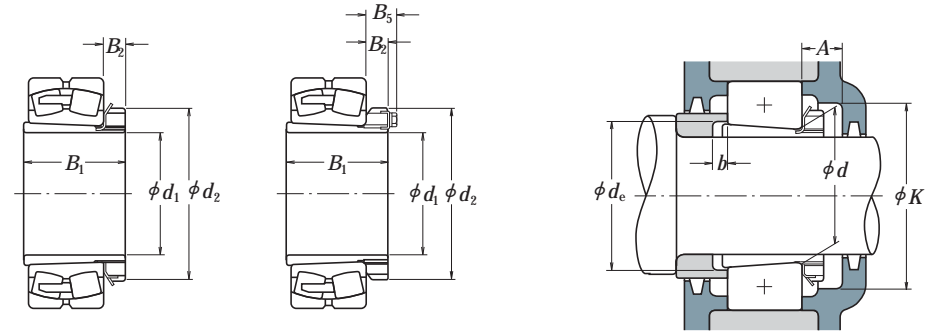

Shaft Diameter (mm) d_1	Nominal Bearing Bore Dia. (mm) d	Nominal Numbers Applicable Bearings	Dimensions (mm)				Adapter Sleeve Numbers	Abutment Dimensions (mm)				Mass (kg) approx.
			B_1	d_2	B_2	B_5		A min.	K min.	d_e min.	b min.	
125	140	23028C DKE4 + H3028	82	165	24	—	A 3028	36	205	147	8	3.15
	140	23128C KE4 + H3128	97	180	24	—	A 3128	36	205	149	8	4.35
	140	22228C DKE4 + H3128	97	180	24	—	A 3128	36	205	149	8	4.35
	140	23228C KE4 + H2328	131	180	24	—	A 2328	36	205	152	22	5.55
	140	22328C KE4 + H2328	131	180	24	—	A 2328	36	205	152	8	5.55
	135	150	23030C DKE4 + H3030	87	180	26	—	A 3030	37	220	158	8
150		23130C KE4 + H3130	111	195	26	—	A 3130	37	220	160	8	5.5
150		22230C DKE4 + H3130	111	195	26	—	A 3130	37	220	160	15	5.5
150		23230C KE4 + H2330	139	195	26	—	A 2330	37	220	163	20	6.6
150		22330C KE4 + H2330	139	195	26	—	A 2330	37	220	163	8	6.6
140		160	23932C AKE4 + H3932	78	190	28	—	A 3932	39	205	168	8
	160	23032C DKE4 + H3032	93	190	28	—	A 3032	39	230	168	8	5.2
	160	23132C KE4 + H3132	119	210	28	—	A 3132	39	230	170	8	7.65
	160	22232C DKE4 + H3132	119	210	28	—	A 3132	39	230	170	14	7.65
	160	23232C KE4 + H2332	147	210	28	—	A 2332	39	230	174	18	9.15
	160	22332C AKE4 + H2332	147	210	28	—	A 2332	39	230	174	8	9.15
150	170	23934B CAKE4 + H3934	79	200	29	—	A 3934	40	215	179	8	5.07
	170	23034C DKE4 + H3034	101	200	29	—	A 3034	40	250	179	8	6.0
	170	23134C KE4 + H3134	122	220	29	—	A 3134	40	250	180	8	8.4
	170	22234C DKE4 + H3134	122	220	29	—	A 3134	40	250	180	10	8.4
	170	23234C KE4 + H2334	154	220	29	—	A 2334	40	250	185	18	10
	170	22334C AKE4 + H2334	154	220	29	—	A 2334	40	250	185	8	10
160	180	23936C AKE4 + H3936	87	210	30	—	A 3936	41	230	189	8	5.87
	180	23036C DKE4 + H3036	109	210	30	—	A 3036	41	260	189	8	6.85
	180	23136C KE4 + H3136	131	230	30	—	A 3136	41	260	191	8	9.5
	180	22236C DKE4 + H3136	131	230	30	—	A 3136	41	260	191	18	9.5
	180	23236C KE4 + H2336	161	230	30	—	A 2336	41	260	195	22	11.5
	180	22336C AKE4 + H2336	161	230	30	—	A 2336	41	260	195	8	11.5
170	190	23938C AKE4 + H3938	89	220	31	—	A 3938	43	240	199	9	6.35
	190	23038C AKE4 + H3038	112	220	31	—	A 3038	43	270	199	9	7.45
	190	23138C KE4 + H3138	141	240	31	—	A 3138	43	270	202	9	11
	190	22238C AKE4 + H3138	141	240	31	—	A 3138	43	270	202	21	11
	190	23238C KE4 + H2338	169	240	31	—	A 2338	43	270	206	21	12.5
	190	22338C AKE4 + H2338	169	240	31	—	A 2338	43	270	206	9	12.5

Shaft Diameter (mm) d_1	Nominal Bearing Bore Dia. (mm) d	Nominal Numbers Applicable Bearings	Dimensions (mm)				Adapter Sleeve Numbers	Abutment Dimensions (mm)				Mass (kg) approx.
			B_1	d_2	B_2	B_5		A min.	K min.	d_e min.	b min.	
180	200	23940C AKE4 + H3940	98	240	32	—	A 3940	46	260	210	10	8.0
	200	23040C AKE4 + H3040	120	240	32	—	A 3040	46	280	210	10	9.2
	200	23140C KE4 + H3140	150	250	32	—	A 3140	46	280	212	10	12
	200	22240C AKE4 + H3140	150	250	32	—	A 3140	46	280	212	24	12
200	200	23240C KE4 + H2340	176	250	32	—	A 2340	46	280	216	20	14
	200	22340C AKE4 + H2340	176	250	32	—	A 2340	46	280	216	10	14
	220	23944C AKE4 + H3944	96	260	30	41	A 3944	55	280	231	10	8.32
200	220	23044C AKE4 + H3044	128	260	30	41	A 3044	55	320	231	12	10.5
	220	23144C KE4 + H3144	158	280	32	44	A 3144	55	320	233	10	14.5
	220	22244C AKE4 + H3144	158	280	32	44	A 3144	55	320	233	22	14.5
220	220	23244C KE4 + H2344	183	280	32	44	A 2344	55	320	236	11	16.5
	220	22344C AKE4 + H2344	183	280	32	44	A 2344	55	320	236	10	16.5
	240	23948C AKE4 + H3948	101	290	34	46	A 3948	60	300	251	11	11.2
220	240	23048C AKE4 + H3048	133	290	34	46	A 3048	60	340	251	11	13
	240	23148C KE4 + H3148	169	300	34	46	A 3148	60	340	254	11	17.5
	240	22248C AKE4 + H3148	169	300	34	46	A 3148	60	340	254	19	17.5
240	240	23248C AKE4 + H2348	196	300	34	46	A 2348	60	340	257	6	19.5
	240	22348C AKE4 + H2348	196	300	34	46	A 2348	60	340	257	11	19.5
	260	23952C AKE4 + H3952	116	310	34	46	A 3952	60	330	272	11	13.4
240	260	23052C AKE4 + H3052	147	310	34	46	A 3052	60	370	272	13	15.5
	260	23152C AKE4 + H3152	187	330	36	49	A 3152	60	370	276	11	22
	260	22252C AKE4 + H3152	187	330	36	49	A 3152	60	370	276	25	22
260	260	23252C AKE4 + H2352	208	330	36	49	A 2352	60	370	278	2	24
	260	22352C AKE4 + H2352	208	330	36	49	A 2352	60	370	278	11	24
	280	23956C AKE4 + H3956	121	330	38	50	A 3956	65	350	292	12	15.5
260	280	23056C AKE4 + H3056	152	330	38	50	A 3056	65	390	292	12	17.5
	280	23156C AKE4 + H3156	192	350	38	51	A 3156	65	390	296	12	24.5
	280	22256C AKE4 + H3156	192	350	38	51	A 3156	65	390	296	28	24.5
280	280	23256C AKE4 + H2356	221	350	38	51	A 2356	65	390	299	11	28
	280	22356C AKE4 + H2356	221	350	38	51	A 2356	65	390	299	12	28

Shaft Diameter 280 – 410 mm

Shaft Diameter 430 – 470 mm

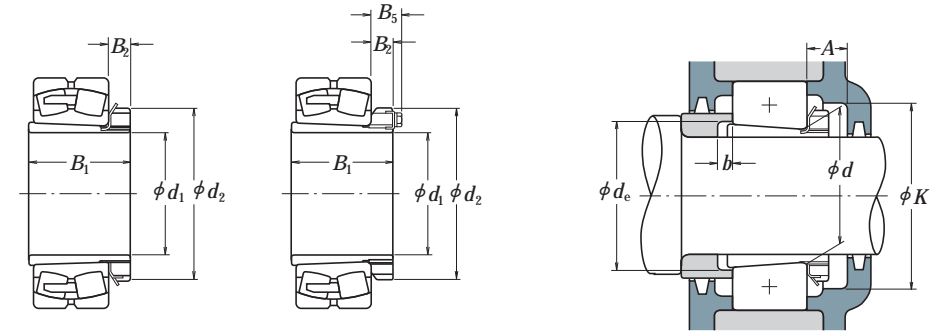
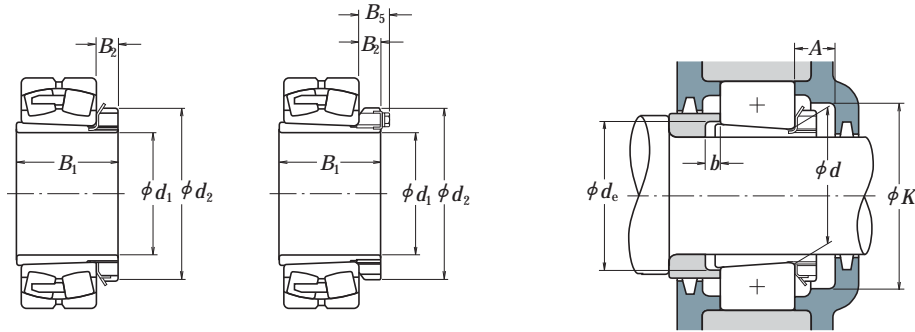

Shaft Diameter (mm) d_1	Nominal Bearing Bore Dia. (mm) d	Nominal Numbers Applicable Bearings	Dimensions (mm)				Adapter Sleeve Numbers	Abutment Dimensions (mm)				Mass (kg) approx.
			B_1	d_2	B_2	B_5		A min.	K min.	d_e min.	b min.	
280	300	23960C AKE4 + H3960	140	360	42	54	A3960	69	380	313	12	20.7
	300	23060C AKE4 + H3060	168	360	42	54	A3060	69	430	313	12	23
	300	23160C AKE4 + H3160	208	380	40	53	A3160	69	430	317	12	30
	300	22260C AKE4 + H3160	208	380	40	53	A3160	69	430	317	32	30
	300	23260C AKE4 + H3260	240	380	40	53	A3260	69	430	321	12	34
	300	320	23964C AKE4 + H3964	140	380	42	55	A3964	72	400	334	13
320		23064C AKE4 + H3064	171	380	42	55	A3064	72	450	334	13	24.5
320		23164C AKE4 + H3164	226	400	42	56	A3164	72	450	339	13	35
320		22264C AKE4 + H3164	226	400	42	56	A3164	72	450	339	39	35
320		23264C AKE4 + H3264	258	400	42	56	A3264	72	450	343	13	39.5
320		340	23968C AKE4 + H3968	144	400	45	58	A3968	75	430	354	14
	340	23068C AKE4 + H3068	187	400	45	58	A3068	75	490	355	14	28.5
	340	23168C AKE4 + H3168	254	440	55	72	A3168	75	490	360	14	49.5
	340	23268C AKE4 + H3268	288	440	55	72	A3268	75	490	364	14	54.5
340	360	23972C AKE4 + H3972	144	420	45	58	A3972	75	450	374	14	25.7
	360	23072C AKE4 + H3072	188	420	45	58	A3072	75	510	375	14	30.5
	360	23172C AKE4 + H3172	259	460	58	75	A3172	75	510	380	14	54
	360	23272C AKE4 + H3272	299	460	58	75	A3272	75	510	385	14	60.5
360	380	23976C AKE4 + H3976	164	450	48	62	A3976	82	480	396	15	31.9
	380	23076C AKE4 + H3076	193	450	48	62	A3076	82	540	396	15	36
	380	23176C AKE4 + H3176	264	490	60	77	A3176	82	540	401	15	61.5
	380	23276C AKE4 + H3276	310	490	60	77	A3276	82	540	405	15	69.5
380	400	23980C AKE4 + H3980	168	470	52	66	A3980	86	500	417	15	35.2
	400	23080C AKE4 + H3080	210	470	52	66	A3080	86	580	417	15	41.5
	400	23180C AKE4 + H3180	272	520	62	82	A3180	86	580	421	15	70.5
	400	23280C AKE4 + H3280	328	520	62	82	A3280	86	580	427	15	81
400	420	23984C AKE4 + H3984	168	490	52	66	A3984	86	520	437	16	36.6
	420	23084C AKE4 + H3084	212	490	52	66	A3084	86	600	437	16	43.5
	420	23184C AKE4 + H3184	304	540	70	90	A3184	86	600	443	16	84
	420	23284C AKE4 + H3284	352	540	70	90	A3284	86	600	448	16	94
410	440	23988C AKE4 + H3988	189	520	60	77	A3988	99	550	458	17	58.6
	440	23088C AKE4 + H3088	228	520	60	77	A3088	99	620	458	17	65
	440	23188C AKE4 + H3188	307	560	70	90	A3188	99	620	464	17	104
	440	23288C AKE4 + H3288	361	560	70	90	A3288	99	620	469	17	118

Shaft Diameter (mm) d_1	Nominal Bearing Bore Dia. (mm) d	Nominal Numbers Applicable Bearings	Dimensions (mm)				Adapter Sleeve Numbers	Abutment Dimensions (mm)				Mass (kg) approx.
			B_1	d_2	B_2	B_5		A min.	K min.	d_e min.	b min.	
430	460	23992C AKE4 + H3992	189	540	60	77	A3992	99	570	478	17	62
	460	23092C AKE4 + H3092	234	540	60	77	A3092	99	650	478	17	69.5
	460	23192C AKE4 + H3192	326	580	75	95	A3192	99	650	485	17	116
	460	23292C AKE4 + H3292	382	580	75	95	A3292	99	650	491	17	132
450	480	23996C AKE4 + H3996	200	560	60	77	A3996	99	600	499	18	67.5
	480	23096C AKE4 + H3096	237	560	60	77	A3096	99	690	499	18	73.5
	480	23196C AKE4 + H3196	335	620	75	95	A3196	99	690	505	18	133
	480	23296C AKE4 + H3296	397	620	75	95	A3296	99	690	512	18	152
470	500	239/500C AKE4 + H39/500	208	580	68	85	A39/500	109	620	519	18	74.6
	500	230/500C AKE4 + H30/500	247	580	68	85	A30/500	109	700	519	18	82
	500	231/500C AKE4 + H31/500	356	630	80	100	A31/500	109	700	527	18	143
	500	232/500C AKE4 + H32/500	428	630	80	100	A32/500	109	700	534	18	166

Shaft Diameter 35 – 85 mm

Shaft Diameter 90 – 135 mm

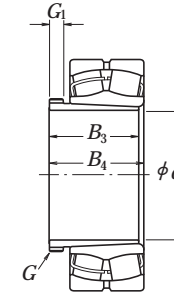
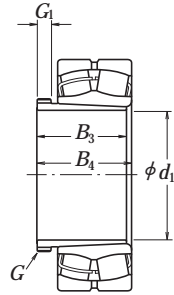

Shaft Diameter (mm) d_1	Nominal Bearing Bore Dia. (mm) d	Nominal Numbers Applicable Bearings	Screw Thread G	Dimensions (mm)			Mass (kg) approx.
				B_3	G_1	B_1	
35	40	21308EAKE4 + AH 308	M 45 × 1.5	29	6	32	0.09
	40	22308EAKE4 + AH 2308	M 45 × 1.5	40	7	43	0.13
40	45	21309EAKE4 + AH 309	M 50 × 1.5	31	6	34	0.11
	45	22309EAKE4 + AH 2309	M 50 × 1.5	44	7	47	0.165
45	50	21310EAKE4 + AHX 310	M 55 × 2	35	7	38	0.16
	50	22310EAKE4 + AHX 2310	M 55 × 2	50	9	53	0.235
50	55	22211EAKE4 + AHX 311	M 60 × 2	37	7	40	0.19
	55	21311EAKE4 + AHX 311	M 60 × 2	37	7	40	0.19
	55	22311EAKE4 + AHX 2311	M 60 × 2	54	10	57	0.285
55	60	22212EAKE4 + AHX 312	M 65 × 2	40	8	43	0.215
	60	21312EAKE4 + AHX 312	M 65 × 2	40	8	43	0.215
	60	22312EAKE4 + AHX 2312	M 65 × 2	58	11	61	0.34
60	65	22213EAKE4 + AH 313	M 75 × 2	42	8	45	0.255
	65	21313EAKE4 + AH 313	M 75 × 2	42	8	45	0.255
	65	22313EAKE4 + AH 2313	M 75 × 2	61	12	64	0.395
65	70	22214EAKE4 + AH 314	M 80 × 2	43	8	47	0.28
	70	21314EAKE4 + AH 314	M 80 × 2	43	8	47	0.28
	70	22314EAKE4 + AHX 2314	M 80 × 2	64	12	68	0.53
70	75	22215EAKE4 + AH 315	M 85 × 2	45	8	49	0.315
	75	21315EAKE4 + AH 315	M 85 × 2	45	8	49	0.315
	75	22315EAKE4 + AHX 2315	M 85 × 2	68	12	72	0.605
75	80	22216EAKE4 + AH 316	M 90 × 2	48	8	52	0.365
	80	21316EAKE4 + AH 316	M 90 × 2	48	8	52	0.365
	80	22316EAKE4 + AHX 2316	M 90 × 2	71	12	75	0.665
80	85	22217EAKE4 + AHX 317	M 95 × 2	52	9	56	0.48
	85	21317EAKE4 + AHX 317	M 95 × 2	52	9	56	0.48
	85	22317EAKE4 + AHX 2317	M 95 × 2	74	13	78	0.745
85	90	22218EAKE4 + AHX 318	M 100 × 2	53	9	57	0.52
	90	21318EAKE4 + AHX 318	M 100 × 2	53	9	57	0.52
	90	23218CKE4 + AHX 3218	M 100 × 2	63	10	67	0.58
	90	22318EAKE4 + AHX 2318	M 100 × 2	79	14	83	0.845

Shaft Diameter (mm) d_1	Nominal Bearing Bore Dia. (mm) d	Nominal Numbers Applicable Bearings	Screw Thread G	Dimensions (mm)			Mass (kg) approx.
				B_3	G_1	B_1	
90	95	22219EAKE4 + AHX 319	M 105 × 2	57	10	61	0.595
	95	21319CKE4 + AHX 319	M 105 × 2	57	10	61	0.595
	95	22319EAKE4 + AHX 2319	M 105 × 2	85	16	89	0.89
95	100	21320CKE4 + AHX 3120	M 110 × 2	64	11	68	0.70
	100	22220EAKE4 + AHX 320	M 110 × 2	59	10	63	0.66
	100	21320CKE4 + AHX 320	M 110 × 2	59	10	63	0.66
	100	23220CKE4 + AHX 3220	M 110 × 2	73	11	77	0.77
	100	22320EAKE4 + AHX 2320	M 110 × 2	90	16	94	1.0
105	110	23122CKE4 + AHX 3122	M 120 × 2	68	11	72	0.76
	110	22222EAKE4 + AHX 3122	M 120 × 2	68	11	72	0.76
	110	24122CK30E4 + AH 24122	M 115 × 2	82	13	91	0.73
110	110	23222CKE4 + AHX 3222	M 125 × 2	82	11	86	1.04
	110	22322EAKE4 + AHX 2322	M 125 × 2	98	16	102	1.35
	110	23222CKE4 + AHX 3222	M 125 × 2	98	16	102	1.35
115	120	23024CDKE4 + AHX 3024	M 130 × 2	60	13	64	0.75
	120	24024CK30E4 + AH 24024	M 125 × 2	73	13	82	0.70
	120	23124CKE4 + AHX 3124	M 130 × 2	75	12	79	0.95
120	120	22224EAKE4 + AHX 3124	M 130 × 2	75	12	79	0.95
	120	24124CK30E4 + AH 24124	M 130 × 2	93	13	102	1.02
	120	23224CKE4 + AHX 3224	M 135 × 2	90	13	94	1.3
	120	22324EAKE4 + AHX 2324	M 135 × 2	105	17	109	1.6
	120	23224CKE4 + AHX 3224	M 135 × 2	105	17	109	1.6
125	130	23026CDKE4 + AHX 3026	M 140 × 2	67	14	71	0.95
	130	24026CK30E4 + AH 24026	M 135 × 2	83	14	93	0.89
	130	23126CKE4 + AHX 3126	M 140 × 2	78	12	82	1.08
130	130	22226EAKE4 + AHX 3126	M 140 × 2	78	12	82	1.08
	130	24126CK30E4 + AH 24126	M 140 × 2	94	14	104	1.14
	130	23226CKE4 + AHX 3226	M 145 × 2	98	15	102	1.58
	130	22326CKE4 + AHX 2326	M 145 × 2	115	19	119	1.97
	130	23226CKE4 + AHX 3226	M 145 × 2	115	19	119	1.97
135	140	23028CDKE4 + AHX 3028	M 150 × 2	68	14	73	1.01
	140	24028CK30E4 + AH 24028	M 145 × 2	83	14	93	0.96
	140	23128CKE4 + AHX 3128	M 150 × 2	83	14	88	1.28
	140	22228CDKE4 + AHX 3128	M 150 × 2	83	14	88	1.28
140	140	24128CK30E4 + AH 24128	M 150 × 2	99	14	109	1.3
	140	23228CKE4 + AHX 3228	M 155 × 3	104	15	109	1.84
	140	22328CKE4 + AHX 2328	M 155 × 3	125	20	130	2.33
	140	23228CKE4 + AHX 3228	M 155 × 3	125	20	130	2.33
	140	22328CKE4 + AHX 2328	M 155 × 3	125	20	130	2.33

Shaft Diameter 145 – 180 mm

Shaft Diameter 190 – 260 mm

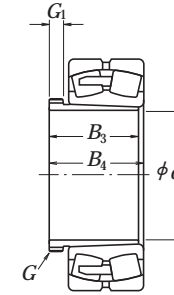
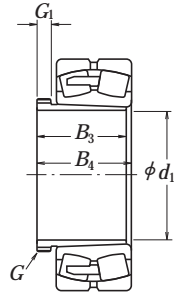

Shaft Diameter (mm) d_1	Nominal Bearing Bore Dia. (mm) d	Nominal Numbers Applicable Bearings	Screw Thread G	Dimensions (mm)			Mass (kg) approx.	
				B_3	G_1	B_4		
145	150	23030CDKE4 + AHX 3030	M 160 × 3	72	15	77	1.15	
	150	24030CK30E4 + AH 24030	M 155 × 3	90	15	101	1.11	
	150	23130CKE4 + AHX 3130	M 165 × 3	96	15	101	1.79	
	150	22230CDKE4 + AHX 3130	M 165 × 3	96	15	101	1.79	
	150	24130CK30E4 + AH 24130	M 160 × 3	115	15	126	1.63	
	150	23230CKE4 + AHX 3230	M 165 × 3	114	17	119	2.22	
	150	22330CAKE4 + AHX 2330	M 165 × 3	135	24	140	2.82	
	150	160	23032CDKE4 + AH 3032	M 170 × 3	77	16	82	2.05
		160	24032CK30E4 + AH 24032	M 170 × 3	95	15	106	2.28
160		23132CKE4 + AH 3132	M 180 × 3	103	16	108	3.2	
160		22232CDKE4 + AH 3132	M 180 × 3	103	16	108	3.2	
160		24132CK30E4 + AH 24132	M 170 × 3	124	15	135	3.03	
160		23232CKE4 + AH 3232	M 180 × 3	124	20	130	4.1	
160		22332CAKE4 + AH 2332	M 180 × 3	140	24	146	4.7	
160		170	23034CDKE4 + AH 3034	M 180 × 3	85	17	90	2.45
		170	24034CK30E4 + AH 24034	M 180 × 3	106	16	117	2.74
	170	23134CKE4 + AH 3134	M 190 × 3	104	16	109	3.4	
	170	22234CDKE4 + AH 3134	M 190 × 3	104	16	109	3.4	
	170	24134CK30E4 + AH 24134	M 180 × 3	125	16	136	3.26	
	170	23234CKE4 + AH 3234	M 190 × 3	134	24	140	4.8	
	170	22334CAKE4 + AH 2334	M 190 × 3	146	24	152	5.25	
	170	180	23036CDKE4 + AH 3036	M 190 × 3	92	17	98	2.8
		180	24036CK30E4 + AH 24036	M 190 × 3	116	16	127	3.19
180		23136CKE4 + AH 3136	M 200 × 3	116	19	122	4.2	
180		24136CK30E4 + AH 24136	M 190 × 3	134	16	145	3.74	
180		22236CDKE4 + AH 2236	M 200 × 3	105	17	110	3.75	
180		23236CKE4 + AH 3236	M 200 × 3	140	24	146	5.3	
180		22336CAKE4 + AH 2336	M 200 × 3	154	26	160	5.85	
180		190	23038CAKE4 + AH 3038	Tr 205 × 4	96	18	102	3.35
		190	24038CK30E4 + AH 24038	M 200 × 3	118	18	131	3.47
	190	23138CKE4 + AH 3138	Tr 210 × 4	125	20	131	4.9	
	190	24138CK30E4 + AH 24138	M 200 × 3	146	18	159	4.38	
	190	22238CAKE4 + AH 2238	Tr 210 × 4	112	18	117	4.25	
	190	23238CKE4 + AH 3238	Tr 210 × 4	145	25	152	5.9	
	190	22338CAKE4 + AH 2338	Tr 210 × 4	160	26	167	6.65	

Shaft Diameter (mm) d_1	Nominal Bearing Bore Dia. (mm) d	Nominal Numbers Applicable Bearings	Screw Thread G	Dimensions (mm)			Mass (kg) approx.	
				B_3	G_1	B_4		
190	200	23040CAKE4 + AH 3040	Tr 215 × 4	102	19	108	3.8	
	200	24040CK30E4 + AH 24040	Tr 210 × 4	127	18	140	3.92	
	200	23140CKE4 + AH 3140	Tr 220 × 4	134	21	140	5.5	
	200	24140CK30E4 + AH 24140	Tr 210 × 4	158	18	171	5.0	
	200	22240CAKE4 + AH 2240	Tr 220 × 4	118	19	123	4.7	
	200	23240CKE4 + AH 3240	Tr 220 × 4	153	25	160	6.7	
	200	22340CAKE4 + AH 2340	Tr 220 × 4	170	30	177	7.55	
	200	220	23044CAKE4 + AH 3044	Tr 235 × 4	111	20	117	7.4
		220	24044CK30E4 + AH 24044	Tr 230 × 4	138	20	152	8.23
220		23144CKE4 + AH 3144	Tr 240 × 4	145	23	151	10.5	
220		24144CK30E4 + AH 24144	Tr 230 × 4	170	20	184	10.3	
220		22244CAKE4 + AH 2244	Tr 240 × 4	130	20	136	9.1	
220		23244CKE4 + AH 3244	Tr 240 × 4	181	30	189	13.5	
220		22344CAKE4 + AH 2344	Tr 240 × 4	181	30	189	13.5	
220		240	23048CAKE4 + AH 3048	Tr 260 × 4	116	21	123	8.75
		240	24048CK30E4 + AH 24048	Tr 250 × 4	138	20	153	9.0
	240	23148CKE4 + AH 3148	Tr 260 × 4	154	25	161	12	
	240	24148CK30E4 + AH 24148	Tr 260 × 4	180	20	195	12.6	
	240	22248CAKE4 + AH 2248	Tr 260 × 4	144	21	150	11	
	240	23248CAKE4 + AH 3248	Tr 260 × 4	189	30	197	15.5	
	240	22348CAKE4 + AH 2348	Tr 260 × 4	189	30	197	15.5	
	240	260	23052CAKE4 + AH 3052	Tr 280 × 4	128	23	135	10.5
		260	24052CAK30E4 + AH 24052	Tr 270 × 4	162	22	178	11.7
260		23152CAKE4 + AH 3152	Tr 290 × 4	172	26	179	16	
260		24152CAK30E4 + AH 24152	Tr 280 × 4	202	22	218	15.5	
260		22252CAKE4 + AH 2252	Tr 290 × 4	155	23	161	14	
260		23252CAKE4 + AH 3252	Tr 290 × 4	205	30	213	19.5	
260		22352CAKE4 + AH 2352	Tr 290 × 4	205	30	213	19.5	
260		280	23056CAKE4 + AH 3056	Tr 300 × 4	131	24	139	12
		280	24056CAK30E4 + AH 24056	Tr 290 × 4	162	22	179	12.6
	280	23156CAKE4 + AH 3156	Tr 310 × 5	175	28	183	17.5	
	280	24156CAK30E4 + AH 24156	Tr 300 × 4	202	22	219	16.8	
	280	22256CAKE4 + AH 2256	Tr 310 × 5	155	24	163	15	
	280	23256CAKE4 + AH 3256	Tr 310 × 5	212	30	220	21.5	
	280	22356CAKE4 + AH 2356	Tr 310 × 5	212	30	220	21.5	

Shaft Diameter 280 – 380 mm

Shaft Diameter 400 – 480 mm

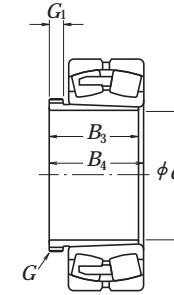
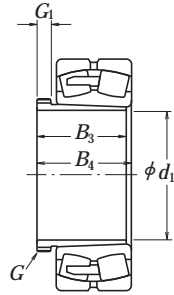

Shaft Diameter (mm) d_1	Nominal Bearing Bore Dia. (mm) d	Nominal Numbers Applicable Bearings	Screw Thread G	Dimensions (mm)			Mass (kg) approx.
				B_3	G_1	B_1	
280	300	23060CAKE4 + AH 3060	Tr 320 × 5	145	26	153	14.5
	300	24060CAK30E4 + AH 24060	Tr 310 × 5	184	24	202	15.5
	300	23160CAKE4 + AH 3160	Tr 330 × 5	192	30	200	21
300	300	24160CAK30E4 + AH 24160	Tr 320 × 5	224	24	242	20.3
	300	22260CAKE4 + AH 2260	Tr 330 × 5	170	26	178	18
	300	23260CAKE4 + AH 3260	Tr 330 × 5	228	34	236	20
300	320	23064CAKE4 + AH 3064	Tr 345 × 5	149	27	157	16
	320	24064CAK30E4 + AH 24064	Tr 330 × 5	184	24	202	16.4
	320	23164CAKE4 + AH 3164	Tr 350 × 5	209	31	217	24.5
320	320	24164CAK30E4 + AH 24164	Tr 340 × 5	242	24	260	23.5
	320	23264CAKE4 + AH 3264	Tr 350 × 5	246	36	254	25
	340	23068CAKE4 + AH 3068	Tr 365 × 5	162	28	171	19.5
340	340	24068CAK30E4 + AH 24068	Tr 360 × 5	206	26	225	21.2
	340	23168CAKE4 + AH 3168	Tr 370 × 5	225	33	234	29
	340	24168CAK30E4 + AH 24168	Tr 360 × 5	269	26	288	28.3
340	340	23268CAKE4 + AH 3268	Tr 370 × 5	264	38	273	35.5
	360	23072CAKE4 + AH 3072	Tr 385 × 5	167	30	176	21
	360	24072CAK30E4 + AH 24072	Tr 380 × 5	206	26	226	22.5
360	360	23172CAKE4 + AH 3172	Tr 400 × 5	229	35	238	33
	360	24172CAK30E4 + AH 24172	Tr 380 × 5	269	26	289	30
	360	23272CAKE4 + AH 3272	Tr 400 × 5	274	40	283	41.5
360	380	23076CAKE4 + AH 3076	Tr 410 × 5	170	31	180	23.5
	380	24076CAK30E4 + AH 24076	Tr 400 × 5	208	28	228	24.1
	380	23176CAKE4 + AH 3176	Tr 420 × 5	232	36	242	35.5
380	380	24176CAK30E4 + AH 24176	Tr 400 × 5	271	28	291	32.1
	380	23276CAKE4 + AH 3276	Tr 420 × 5	284	42	294	45.5
	400	23080CAKE4 + AH 3080	Tr 430 × 5	183	33	193	27.5
400	400	24080CAK30E4 + AH 24080	Tr 420 × 5	228	28	248	28
	400	23180CAKE4 + AH 3180	Tr 440 × 5	240	38	250	39.5
	400	24180CAK30E4 + AH 24180	Tr 420 × 5	278	28	298	34.8
400	23280CAKE4 + AH 3280	Tr 440 × 5	302	44	312	51.5	

Shaft Diameter (mm) d_1	Nominal Bearing Bore Dia. (mm) d	Nominal Numbers Applicable Bearings	Screw Thread G	Dimensions (mm)			Mass (kg) approx.
				B_3	G_1	B_1	
400	420	23084CAKE4 + AH 3084	Tr 450 × 5	186	34	196	29
	420	24084CAK30E4 + AH 24084	Tr 440 × 5	230	30	252	29.8
	420	23184CAKE4 + AH 3184	Tr 460 × 5	266	40	276	46.5
420	420	24184CAK30E4 + AH 24184	Tr 440 × 5	310	30	332	41.4
	420	23284CAKE4 + AH 3284	Tr 460 × 5	321	46	331	59
	440	23088CAKE4 + AHX 3088	Tr 470 × 5	194	35	205	42
440	440	24088CAK30E4 + AH 24088	Tr 460 × 5	242	30	264	33
	440	23188CAKE4 + AHX 3188	Tr 480 × 5	270	42	281	50
	440	24188CAK30E4 + AH 24188	Tr 460 × 5	310	30	332	43.5
440	440	23288CAKE4 + AHX 3288	Tr 480 × 5	330	48	341	64
	460	23092CAKE4 + AHX 3092	Tr 490 × 5	202	37	213	46
	460	24092CAK30E4 + AH 24092	Tr 480 × 5	250	32	273	35.9
460	460	23192CAKE4 + AHX 3192	Tr 510 × 6	285	43	296	58
	460	24192CAK30E4 + AH 24192	Tr 480 × 5	332	32	355	49.7
	460	23292CAKE4 + AHX 3292	Tr 510 × 6	349	50	360	74.5
460	480	23096CAKE4 + AHX 3096	Tr 520 × 6	205	38	217	51
	480	24096CAK30E4 + AH 24096	Tr 500 × 5	250	32	273	37.5
	480	23196CAKE4 + AHX 3196	Tr 530 × 6	295	45	307	63
480	480	24196CAK30E4 + AH 24196	Tr 500 × 5	340	32	363	53
	480	23296CAKE4 + AHX 3296	Tr 530 × 6	364	52	376	82
	500	230/500CAKE4 + AHX 30/500	Tr 540 × 6	209	40	221	54.5
500	500	240/500CAK30E4 + AH 240/500	Tr 530 × 6	253	35	276	41.9
	500	231/500CAKE4 + AHX 31/500	Tr 550 × 6	313	47	325	71
	500	241/500CAK30E4 + AH 241/500	Tr 530 × 6	360	35	383	61.2
500	232/500CAKE4 + AHX 32/500	Tr 550 × 6	393	54	405	94.5	

(For Adapters and Shafts)

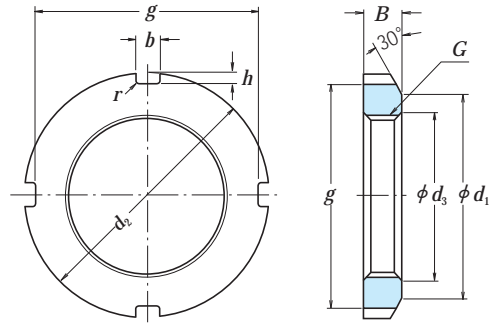

Nut with Washer

Units : mm

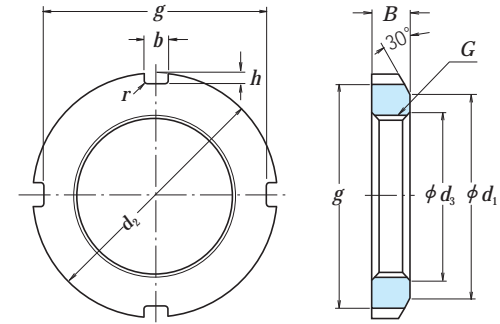

Nut with Washer

Units : mm

Nominal Numbers	Nut Series AN										Reference		
	Screw Threads <i>G</i>	<i>d</i> ₂	<i>d</i> ₁	<i>g</i>	<i>b</i>	<i>h</i>	<i>d</i> ₃	<i>B</i>	<i>r</i> max.	Mass (kg) approx.	Adapter (1) Sleeve Bore Dia. Numbers	Washer Numbers	Shaft Dia.
AN 02	M 15x1	25	21	21	4	2	15.5	5	0.4	0.010	—	AW 02 X	15
AN 03	M 17x1	28	24	24	4	2	17.5	5	0.4	0.013	—	AW 03 X	17
AN 04	M 20x1	32	26	28	4	2	20.5	6	0.4	0.019	04	AW 04 X	20
AN 05	M 25x1.5	38	32	34	5	2	25.8	7	0.4	0.025	05	AW 05 X	25
AN 06	M 30x1.5	45	38	41	5	2	30.8	7	0.4	0.043	06	AW 06 X	30
AN 07	M 35x1.5	52	44	48	5	2	35.8	8	0.4	0.053	07	AW 07 X	35
AN 08	M 40x1.5	58	50	53	6	2.5	40.8	9	0.5	0.085	08	AW 08 X	40
AN 09	M 45x1.5	65	56	60	6	2.5	45.8	10	0.5	0.119	09	AW 09 X	45
AN 10	M 50x1.5	70	61	65	6	2.5	50.8	11	0.5	0.148	10	AW 10 X	50
AN 11	M 55x2	75	67	69	7	3	56	11	0.5	0.158	11	AW 11 X	55
AN 12	M 60x2	80	73	74	7	3	61	11	0.5	0.174	12	AW 12 X	60
AN 13	M 65x2	85	79	79	7	3	66	12	0.5	0.203	13	AW 13 X	65
AN 14	M 70x2	92	85	85	8	3.5	71	12	0.5	0.242	14	AW 14 X	70
AN 15	M 75x2	98	90	91	8	3.5	76	13	0.5	0.287	15	AW 15 X	75
AN 16	M 80x2	105	95	98	8	3.5	81	15	0.6	0.395	16	AW 16 X	80
AN 17	M 85x2	110	102	103	8	3.5	86	16	0.6	0.45	17	AW 17 X	85
AN 18	M 90x2	120	108	112	10	4	91	16	0.6	0.555	18	AW 18 X	90
AN 19	M 95x2	125	113	117	10	4	96	17	0.6	0.66	19	AW 19 X	95
AN 20	M 100x2	130	120	122	10	4	101	18	0.6	0.70	20	AW 20 X	100
AN 21	M 105x2	140	126	130	12	5	106	18	0.7	0.845	21	AW 21 X	105
AN 22	M 110x2	145	133	135	12	5	111	19	0.7	0.965	22	AW 22 X	110
AN 23	M 115x2	150	137	140	12	5	116	19	0.7	1.01	—	AW 23	115
AN 24	M 120x2	155	138	145	12	5	121	20	0.7	1.08	24	AW 24	120
AN 25	M 125x2	160	148	150	12	5	126	21	0.7	1.19	—	AW 25	125

Note (1) Applicable to adapter sleeve Series A31, A2, A3, and A23.

Remarks The basic design and dimensions of screw threads are in accordance with JIS B 0205.

Nominal Numbers	Nut Series AN										Reference		
	Screw Threads <i>G</i>	<i>d</i> ₂	<i>d</i> ₁	<i>g</i>	<i>b</i>	<i>h</i>	<i>d</i> ₃	<i>B</i>	<i>r</i> max.	Mass (kg) approx.	Adapter (1) Sleeve Bore Dia. Numbers	Washer Numbers	Shaft Dia.
AN 26	M 130x2	165	149	155	12	5	131	21	0.7	1.25	26	AW 26	130
AN 27	M 135x2	175	160	163	14	6	136	22	0.7	1.55	—	AW 27	135
AN 28	M 140x2	180	160	168	14	6	141	22	0.7	1.56	28	AW 28	140
AN 29	M 145x2	190	172	178	14	6	146	24	0.7	2.0	—	AW 29	145
AN 30	M 150x2	195	171	183	14	6	151	24	0.7	2.03	30	AW 30	150
AN 31	M 155x3	200	182	186	16	7	156.5	25	0.7	2.21	—	—	—
AN 32	M 160x3	210	182	196	16	7	161.5	25	0.7	2.59	32	AW 32	160
AN 33	M 165x3	210	193	196	16	7	166.5	26	0.7	2.43	—	—	—
AN 34	M 170x3	220	193	206	16	7	171.5	26	0.7	2.8	34	AW 34	170
AN 36	M 180x3	230	203	214	18	8	181.5	27	0.7	3.05	36	AW 36	180
AN 38	M 190x3	240	214	224	18	8	191.5	28	0.7	3.4	38	AW 38	190
AN 40	M 200x3	250	226	234	18	8	201.5	29	0.7	3.7	40	AW 40	200

Nut Series ANL													
Nominal Numbers	Nut Series ANL										Reference		
	Screw Threads <i>G</i>	<i>d</i> ₂	<i>d</i> ₁	<i>g</i>	<i>b</i>	<i>h</i>	<i>d</i> ₃	<i>B</i>	<i>r</i> max.	Mass (kg) approx.	Adapter (1) Sleeve Bore Dia. Numbers	Washer Numbers	Shaft Dia.
ANL 24	M 120x2	145	133	135	12	5	121	20	0.7	0.78	24	AWL 24	120
ANL 26	M 130x2	155	143	145	12	5	131	21	0.7	0.88	26	AWL 26	130
ANL 28	M 140x2	165	151	153	14	6	141	22	0.7	0.99	28	AWL 28	140
ANL 30	M 150x2	180	164	168	14	6	151	24	0.7	1.38	30	AWL 30	150
ANL 32	M 160x3	190	174	176	16	7	161.5	25	0.7	1.56	32	AWL 32	160
ANL 34	M 170x3	200	184	186	16	7	171.5	26	0.7	1.72	34	AWL 34	170
ANL 36	M 180x3	210	192	194	18	8	181.5	27	0.7	1.95	36	AWL 36	180
ANL 38	M 190x3	220	202	204	18	8	191.5	28	0.7	2.08	38	AWL 38	190
ANL 40	M 200x3	240	218	224	18	8	201.5	29	0.7	2.98	40	AWL 40	200

Note (1) Series AN is applicable to adapter sleeve Series A31 and A23.

Series ANL is applicable to adapter sleeve Series A30.

Remarks The basic design and dimensions of screw threads are in accordance with JIS B 0205.

(For Adapters and Shafts)

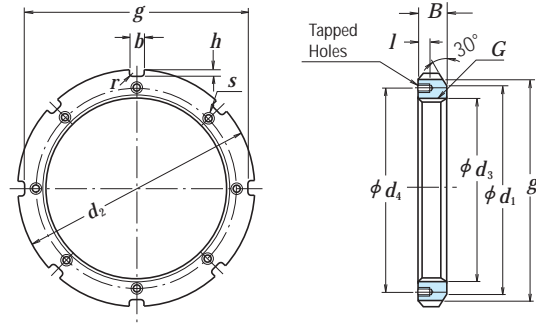

Nut with Stopper

Units : mm

Nominal Numbers	Nut Series AN											Reference				
	Screw Threads G	Basic Dimensions							Mass (kg) approx.	Tapped Holes		Adapter (*) Sleeve Bore Dia. Numbers	Stopper Numbers	Shaft Dia.		
d ₂	d ₁	g	b	h	d ₃	B	r max.	l		Screw Threads (S)	d ₄					
AN 44	Tr 220x4	280	250	260	20	10	222	32	0.8	15	M 8x1.25	238	5.2	44	AL 44	220
AN 48	Tr 240x4	300	270	280	20	10	242	34	0.8	15	M 8x1.25	258	5.95	48	AL 44	240
AN 52	Tr 260x4	330	300	306	24	12	262	36	0.8	18	M 10x1.5	281	8.05	52	AL 52	260
AN 56	Tr 280x4	350	320	326	24	12	282	38	0.8	18	M 10x1.5	301	9.05	56	AL 52	280
AN 60	Tr 300x4	380	340	356	24	12	302	40	0.8	18	M 10x1.5	326	11.8	60	AL 60	300
AN 64	Tr 320x5	400	360	376	24	12	322.5	42	0.8	18	M 10x1.5	345	13.1	64	AL 64	320
AN 68	Tr 340x5	440	400	410	28	15	342.5	55	1	21	M 12x1.75	372	23.1	68	AL 68	340
AN 72	Tr 360x5	460	420	430	28	15	362.5	58	1	21	M 12x1.75	392	25.1	72	AL 68	360
AN 76	Tr 380x5	490	450	454	32	18	382.5	60	1	21	M 12x1.75	414	31	76	AL 76	380
AN 80	Tr 400x5	520	470	484	32	18	402.5	62	1	27	M 16x2	439	37	80	AL 80	400
AN 84	Tr 420x5	540	490	504	32	18	422.5	70	1	27	M 16x2	459	43.5	84	AL 80	420
AN 88	Tr 440x5	560	510	520	36	20	442.5	70	1	27	M 16x2	477	45	88	AL 88	440
AN 92	Tr 460x5	580	540	540	36	20	462.5	75	1	27	M 16x2	497	50.5	92	AL 88	460
AN 96	Tr 480x5	620	560	580	36	20	482.5	75	1	27	M 16x2	527	62	96	AL 96	480
AN 100	Tr 500x5	630	580	584	40	23	502.5	80	1	27	M 16x2	539	63.5	/500	AL 100	500

Nut Series ANL

ANL 44	Tr 220x4	260	242	242	20	9	222	30	0.8	12	M 6x1	229	3.1	44	ALL 44	220
ANL 48	Tr 240x4	290	270	270	20	10	242	34	0.8	15	M 8x1.25	253	5.15	48	ALL 48	240
ANL 52	Tr 260x4	310	290	290	20	10	262	34	0.8	15	M 8x1.25	273	5.65	52	ALL 48	260
ANL 56	Tr 280x4	330	310	310	24	10	282	38	0.8	15	M 8x1.25	293	6.8	56	ALL 56	280
ANL 60	Tr 300x4	360	336	336	24	12	302	42	0.8	15	M 8x1.25	316	9.6	60	ALL 60	300
ANL 64	Tr 320x5	380	356	356	24	12	322.5	42	0.8	15	M 8x1.25	335	9.95	64	ALL 64	320
ANL 68	Tr 340x5	400	376	376	24	12	342.5	45	1	15	M 8x1.25	355	11.7	68	ALL 64	340
ANL 72	Tr 360x5	420	394	394	28	13	362.5	45	1	15	M 8x1.25	374	12	72	ALL 72	360
ANL 76	Tr 380x5	450	422	422	28	14	382.5	48	1	18	M 10x1.5	398	14.9	76	ALL 76	380
ANL 80	Tr 400x5	470	442	442	28	14	402.5	52	1	18	M 10x1.5	418	16.9	80	ALL 76	400
ANL 84	Tr 420x5	490	462	462	32	14	422.5	52	1	18	M 10x1.5	438	17.4	84	ALL 84	420
ANL 88	Tr 440x5	520	490	490	32	15	442.5	60	1	21	M 12x1.75	462	26.2	88	ALL 88	440
ANL 92	Tr 460x5	540	510	510	32	15	462.5	60	1	21	M 12x1.75	482	28	92	ALL 88	460
ANL 96	Tr 480x5	560	530	530	36	15	482.5	60	1	21	M 12x1.75	502	29.5	96	ALL 96	480
ANL 100	Tr 500x5	580	550	550	36	15	502.5	68	1	21	M 12x1.75	522	33.5	/500	ALL 96	500

Note (*) Series AN is applicable to adapter sleeve Series A31, A32 and A23. Series ANL is applicable to adapter sleeve Series A30.

Remarks 1. The basic design and dimensions of screw threads are in accordance with JIS B 0216.
2. The basic design and dimensions of threads in tapped holes are in accordance with JIS B 0205.

(For Withdrawal Sleeves)

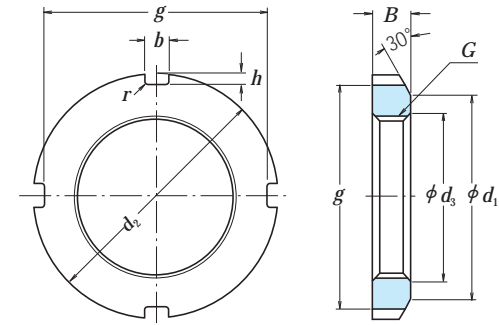

Units : mm

Nominal Numbers	Nut Series HN											Reference			
	Screw Threads G	Basic Dimensions							Mass (kg) approx.	Withdrawal Sleeve Numbers					
d ₂	d ₁	g	b	h	d ₃	B	r max.	AH 31		AH 22	AH 32	AH 23			
HN 42	Tr 210x4	270	238	250	20	10	212	30	0.8	4.75	AH 3138	AH 2238	AH 3238	AH 2338	
HN 44	Tr 220x4	280	250	260	20	10	222	32	0.8	5.35	AH 3140	AH 2240	AH 3240	AH 2340	
HN 48	Tr 240x4	300	270	280	20	10	242	34	0.8	6.2	AH 3144	AH 2244	—	AH 2344	
HN 52	Tr 260x4	330	300	306	24	12	262	36	0.8	8.55	AH 3148	AH 2248	—	AH 2348	
HN 58	Tr 290x4	370	330	346	24	12	292	40	0.8	11.8	AH 3152	AH 2252	—	AH 2352	
HN 62	Tr 310x5	390	350	366	24	12	312.5	42	0.8	13.4	AH 3156	AH 2256	—	AH 2356	
HN 66	Tr 330x5	420	380	390	28	15	332.5	52	1	20.4	AH 3160	AH 2260	AH 3260	—	
HN 70	Tr 350x5	450	410	420	28	15	352.5	55	1	25.2	AH 3164	AH 2264	AH 3264	—	
HN 74	Tr 370x5	470	430	440	28	15	372.5	58	1	28.2	AH 3168	—	AH 3268	—	
HN 80	Tr 400x5	520	470	484	32	18	402.5	62	1	40	AH 3172	—	AH 3272	—	
HN 84	Tr 420x5	540	490	504	32	18	422.5	70	1	46.9	AH 3176	—	AH 3276	—	
HN 88	Tr 440x5	560	510	520	36	20	442.5	70	1	48.5	AH 3180	—	AH 3280	—	
HN 92	Tr 460x5	580	540	540	36	20	462.5	75	1	55	AH 3184	—	AH 3284	—	
HN 96	Tr 480x5	620	560	580	36	20	482.5	75	1	67	AH 3188	—	AH 3288	—	
HN 102	Tr 510x6	650	590	604	40	23	513	80	1	75	AH 3192	—	AH 3292	—	
HN 106	Tr 530x6	670	610	624	40	23	533	80	1	78	AH 3196	—	AH 3296	—	
HN 110	Tr 550x6	700	640	654	40	23	553	80	1	92.5	AH 31500	—	AH 32500	—	

Nut Series HNL

HNL 41	Tr 205x4	250	232	234	18	8	207	30	0.8	3.45	AH 3038	AH 238	—	—
HNL 43	Tr 215x4	260	242	242	20	9	217	30	0.8	3.7	AH 3040	AH 240	—	—
HNL 47	Tr 235x4	280	262	262	20	9	237	34	0.8	4.6	AH 3044	AH 244	—	—
HNL 52	Tr 260x4	310	290	290	20	10	262	34	0.8	5.8	AH 3048	AH 248	—	—
HNL 56	Tr 280x4	330	310	310	24	10	282	38	0.8	6.7	AH 3052	AH 252	—	—
HNL 60	Tr 300x4	360	336	336	24	12	302	42	0.8	9.6	AH 3056	AH 256	—	—
HNL 64	Tr 320x5	380	356	356	24	12	322.5	42	1	10.3	AH 3060	—	—	—
HNL 69	Tr 345x5	410	384	384	28	13	347.5	45	1	11.5	AH 3064	—	—	—
HNL 73	Tr 365x5	430	404	404	28	13	367.5	48	1	14.2	AH 3068	—	—	—
HNL 77	Tr 385x5	450	422	422	28	14	387.5	48	1	15	AH 3072	—	—	—
HNL 82	Tr 410x5	480	452	452	32	14	412.5	52	1	19	AH 3076	—	—	—
HNL 86	Tr 430x5	500	472	472	32	14	432.5	52	1	19.8	AH 3080	—	—	—
HNL 90	Tr 450x5	520	490	490	32	15	452.5	60	1	23.8	AH 3084	—	—	—
HNL 94	Tr 470x5	540	510	510	32	15	472.5	60	1	25	AH 3088	—	—	—
HNL 98	Tr 490x5	580	550	550	36	15	492.5	60	1	34	AH 3092	—	—	—
HNL 104	Tr 520x6	600	570	570	36	15	523	68	1	37	AH 3096	—	—	—
HNL 108	Tr 540x6	630	590	590	40	20	543	68	1	43.5	AH 30500	—	—	—

Remarks 1. The basic design and dimensions of screw threads are in accordance with JIS B 0216.
2. The number of notches in the nut may be bigger than that shown in the above figure.

(Combination of Withdrawal Sleeves and Nuts)

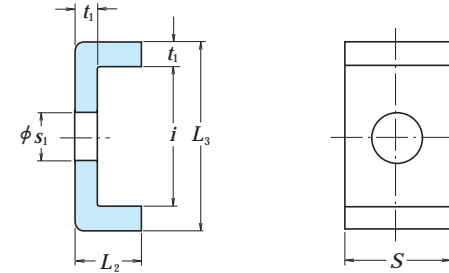

Nominal Numbers	Reference						
	Withdrawal Sleeve Numbers						
	AH 30	AH 31	AH 2	AH 22	AH 32	AH 3	AH 23
AN 09	—	—	AH 208	—	—	AH 308	AH 2308
AN 10	—	—	AH 209	—	—	AH 309	AH 2309
AN 11	—	—	AH 210	—	—	AHX 310	AHX 2310
AN 12	—	—	AH 211	—	—	AHX 311	AHX 2311
AN 13	—	—	AH 212	—	—	AHX 312	AHX 2312
AN 14	—	—	—	—	—	—	—
AN 15	—	—	AH 213	—	—	AH 313	AH 2313
AN 16	—	—	AH 214	—	—	AH 314	AHX 2314
AN 17	—	—	AH 215	—	—	AH 315	AHX 2315
AN 18	—	—	AH 216	—	—	AH 316	AHX 2316
AN 19	—	—	AH 217	—	—	AHX 317	AHX 2317
AN 20	—	—	AH 218	—	AHX 3218	AHX 318	AHX 2318
AN 21	—	—	AH 219	—	—	AHX 319	AHX 2319
AN 22	—	—	AH 220	—	AHX 3220	AHX 320	AHX 2320
AN 23	—	—	AH 221	—	—	AHX 321	—
AN 24	—	AHX 3122	AH 222	—	—	AHX 322	—
AN 25	—	—	—	—	AHX 3222	—	AHX 2322
AN 26	AHX 3024	AHX 3124	AH 224	—	—	AHX 324	—
AN 27	—	—	—	—	AHX 3224	—	AHX 2324
AN 28	AHX 3026	AHX 3126	AH 226	—	—	AHX 326	—
AN 29	—	—	—	—	AHX 3226	—	AHX 2326
AN 30	AHX 3028	AHX 3128	AH 228	—	—	AHX 328	—
AN 31	—	—	—	—	AHX 3228	—	AHX 2328
AN 32	AHX 3030	—	AH 230	—	—	—	—
AN 33	—	AHX 3130	—	—	AHX 3230	AHX 330	AHX 2330
AN 34	AH 3032	—	AH 232	—	—	—	—
AN 36	AH 3034	AH 3132	AH 234	—	AH 3232	AH 332	AH 2332
AN 38	AH 3036	AH 3134	AH 236	—	AH 3234	AH 334	AH 2334
AN 40	—	AH 3136	—	AH 2236	AH 3236	—	AH 2336

Units : mm

Nominal Numbers	Stopper Series AL						Mass (kg) per 100 pcs approx.	Reference
	Basic Dimensions							
	t ₁	S	L ₂	s ₁	i	L ₃		
AL 44	4	20	12	9	22.5	30.5	2.6	AN 44, AN 48 AN 52, AN 56 AN 60
AL 52	4	24	12	12	25.5	33.5	3.4	
AL 60	4	24	12	12	30.5	38.5	3.8	
AL 64	5	24	15	12	31	41	5.35	AN 64 AN 68, AN 72 AN 76
AL 68	5	28	15	14	38	48	6.65	
AL 76	5	32	15	14	40	50	7.95	
AL 80	5	32	15	18	45	55	8.2	AN 80, AN 84 AN 88, AN 92 AN 96 AN 100
AL 88	5	36	15	18	43	53	9.0	
AL 96	5	36	15	18	53	63	10.4	
AL 100	5	40	15	18	45	55	10.5	

Nominal Numbers	Stopper Series ALL						Mass (kg) per 100 pcs approx.	Reference
	Basic Dimensions							
	t ₁	S	L ₂	s ₁	i	L ₃		
ALL 44	4	20	12	7	13.5	21.5	2.12	ANL 44 ANL 48, ANL 52 ANL 56
ALL 48	4	20	12	9	17.5	25.5	2.29	
ALL 56	4	24	12	9	17.5	25.5	2.92	
ALL 60	4	24	12	9	20.5	28.5	3.15	ANL 60 ANL 64, ANL 68 ANL 72
ALL 64	5	24	15	9	21	31	4.55	
ALL 72	5	28	15	9	20	30	5.05	
ALL 76	5	28	15	12	24	34	5.3	ANL 76, ANL 80 ANL 84 ANL 88, ANL 92 ANL 96, ANL 100
ALL 84	5	32	15	12	24	34	6.1	
ALL 88	5	32	15	14	28	38	6.45	
ALL 96	5	36	15	14	28	38	7.3	

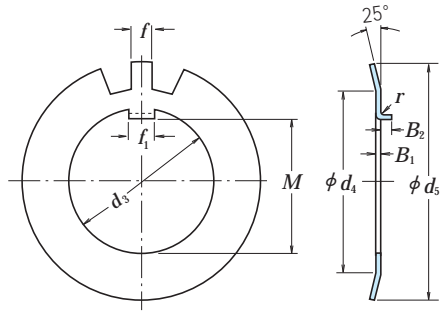

Bent-Tab

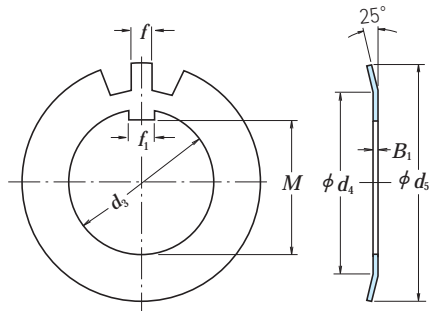

Straight-Tab

Units : mm

Nominal Numbers		Lock-washer Series AW										Reference				
Bent-Tab	Straight-Tab	Basic Dimensions										No. of Teeth	Mass (kg) per 100 pcs approx.	Adapter ⁽¹⁾ Sleeve Bore Dia. Numbers	Nut Numbers	Shaft Dia.
		d ₃	M	f ₁	B ₁	f	d ₄	d ₅	Bent-Tab r	B ₂						
AW 02	AW 02 X	15	13.5	4	1	4	21	28	1	2.5	13	0.253	—	AN 02	15	
AW 03	AW 03 X	17	15.5	4	1	4	24	32	1	2.5	13	0.315	—	AN 03	17	
AW 04	AW 04 X	20	18.5	4	1	4	26	36	1	2.5	13	0.35	04	AN 04	20	
AW 05	AW 05 X	25	23	5	1.2	5	32	42	1	2.5	13	0.64	05	AN 05	25	
AW 06	AW 06 X	30	27.5	5	1.2	5	38	49	1	2.5	13	0.78	06	AN 06	30	
AW 07	AW 07 X	35	32.5	6	1.2	5	44	57	1	2.5	15	1.04	07	AN 07	35	
AW 08	AW 08 X	40	37.5	6	1.2	6	50	62	1	2.5	15	1.23	08	AN 08	40	
AW 09	AW 09 X	45	42.5	6	1.2	6	56	69	1	2.5	17	1.52	09	AN 09	45	
AW 10	AW 10 X	50	47.5	6	1.2	6	61	74	1	2.5	17	1.6	10	AN 10	50	
AW 11	AW 11 X	55	52.5	8	1.2	7	67	81	1	4	17	1.96	11	AN 11	55	
AW 12	AW 12 X	60	57.5	8	1.5	7	73	86	1.2	4	17	2.53	12	AN 12	60	
AW 13	AW 13 X	65	62.5	8	1.5	7	79	92	1.2	4	19	2.9	13	AN 13	65	
AW 14	AW 14 X	70	66.5	8	1.5	8	85	98	1.2	4	19	3.35	14	AN 14	70	
AW 15	AW 15 X	75	71.5	8	1.5	8	90	104	1.2	4	19	3.55	15	AN 15	75	
AW 16	AW 16 X	80	76.5	10	1.8	8	95	112	1.2	4	19	4.65	16	AN 16	80	
AW 17	AW 17 X	85	81.5	10	1.8	8	102	119	1.2	4	19	5.25	17	AN 17	85	
AW 18	AW 18 X	90	86.5	10	1.8	10	108	126	1.2	4	19	6.25	18	AN 18	90	
AW 19	AW 19 X	95	91.5	10	1.8	10	113	133	1.2	4	19	6.7	19	AN 19	95	
AW 20	AW 20 X	100	96.5	12	1.8	10	120	142	1.2	6	19	7.65	20	AN 20	100	
AW 21	AW 21 X	105	100.5	12	1.8	12	126	145	1.2	6	19	8.25	21	AN 21	105	
AW 22	AW 22 X	110	105.5	12	1.8	12	133	154	1.2	6	19	9.4	22	AN 22	110	
AW 23	AW 23 X	115	110.5	12	2	12	137	159	1.5	6	19	10.8	—	AN 23	115	
AW 24	AW 24 X	120	115	14	2	12	138	164	1.5	6	19	10.5	24	AN 24	120	
AW 25	AW 25 X	125	120	14	2	12	148	170	1.5	6	19	11.8	—	AN 25	125	

Note ⁽¹⁾ Applicable to adapter sleeve Series A31, A2, A3, and A23.

Remarks Lock-washers with straight tabs shall be used with adapter sleeves having narrow slits, and for those having wide slits, either type of lock-washer may be used.

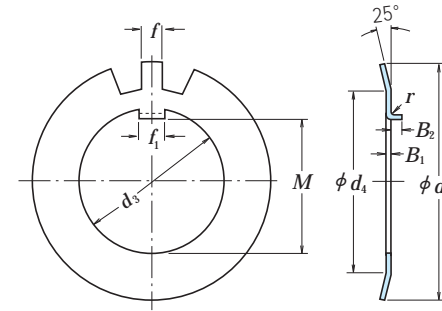

Bent-Tab

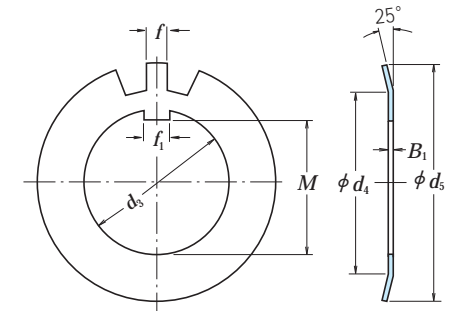

Straight-Tab

Units : mm

Nominal Numbers		Lock-washer Series AW										Reference				
Bent-Tab	Straight-Tab	Basic Dimensions										No. of Teeth	Mass (kg) per 100 pcs approx.	Adapter ⁽¹⁾ Sleeve Bore Dia. Numbers	Nut Numbers	Shaft Dia.
		d ₃	M	f ₁	B ₁	f	d ₄	d ₅	Bent-Tab r	B ₂						
AW 26	AW 26 X	130	125	14	2	12	149	175	1.5	6	19	11.3	26	AN 26	130	
AW 27	AW 27 X	135	130	14	2	14	160	185	1.5	6	19	14.4	—	AN 27	135	
AW 28	AW 28 X	140	135	16	2	14	160	192	1.5	8	19	14.2	28	AN 28	140	
AW 29	AW 29 X	145	140	16	2	14	172	202	1.5	8	19	16.8	—	AN 29	145	
AW 30	AW 30 X	150	145	16	2	14	171	205	1.5	8	19	15.9	30	AN 30	150	
AW 31	AW 31 X	155	147.5	16	2.5	16	182	212	1.5	8	19	20.9	—	AN 31	155	
AW 32	AW 32 X	160	154	18	2.5	16	182	217	1.5	8	19	22.2	32	AN 32	160	
AW 33	AW 33 X	165	157.5	18	2.5	16	193	222	1.5	8	19	24.1	—	AN 33	165	
AW 34	AW 34 X	170	164	18	2.5	16	193	232	1.5	8	19	24.7	34	AN 34	170	
AW 36	AW 36 X	180	174	20	2.5	18	203	242	1.5	8	19	26.8	36	AN 36	180	
AW 38	AW 38 X	190	184	20	2.5	18	214	252	1.5	8	19	27.8	38	AN 38	190	
AW 40	AW 40 X	200	194	20	2.5	18	226	262	1.5	8	19	29.3	40	AN 40	200	

Washer Series AWL

AWL 24	AWL 24 X	120	115	14	2	12	133	155	1.5	6	19	7.7	24	ANL 24	120
AWL 26	AWL 26 X	130	125	14	2	12	143	165	1.5	6	19	8.7	26	ANL 26	130
AWL 28	AWL 28 X	140	135	16	2	14	151	175	1.5	8	19	10.9	28	ANL 28	140
AWL 30	AWL 30 X	150	145	16	2	14	164	190	1.5	8	19	11.3	30	ANL 30	150
AWL 32	AWL 32 X	160	154	18	2.5	16	174	200	1.5	8	19	16.2	32	ANL 32	160
AWL 34	AWL 34 X	170	164	18	2.5	16	184	210	1.5	8	19	19	34	ANL 34	170
AWL 36	AWL 36 X	180	174	20	2.5	18	192	220	1.5	8	19	18	36	ANL 36	180
AWL 38	AWL 38 X	190	184	20	2.5	18	202	230	1.5	8	19	20.5	38	ANL 38	190
AWL 40	AWL 40 X	200	194	20	2.5	18	218	250	1.5	8	19	21.4	40	ANL 40	200

Note ⁽¹⁾ Series AW is applicable to adapter sleeve Series A31 and A23. Series AWL is applicable to adapter sleeve Series A30.

Remarks Lock-washers with straight tabs shall be used with adapter sleeves having narrow slits, and for those having wide slits, either type of lock-washer may be used.

INTRODUCTION OF NSK PRODUCTS · APPENDICES

INTRODUCTION OF NSK PRODUCTS

	Page
Photos of NSK Products	C 2

APPENDICES

Appendix Table 1 Conversion from SI (International Units) System	C 8
Appendix Table 2 N–kgf Force Conversion Table	C10
Appendix Table 3 kg–lb Mass Conversion Table	C11
Appendix Table 4 °C–°F Temperature Conversion Table	C12
Appendix Table 5 Viscosity Conversion Table	C13
Appendix Table 6 inch–mm Dimension Conversion Table	C14
Appendix Table 7 Hardness Conversion Table	C16
Appendix Table 8 Physical and Mechanical Properties of Materials	C17
Appendix Table 9 Tolerances for Shaft Diameters	C18
Appendix Table 10 Tolerances for Housing Bore Diameters	C20
Appendix Table 11 Values of Standard Tolerance Grades IT	C22
Appendix Table 12 Speed Factor f_n	C24
Appendix Table 13 Fatigue Life Factor f_n and Fatigue Life $L \cdot L_n$	C25
Appendix Table 14 Index of Inch Design Tapered Roller Bearings	C26

AUTOMOTIVE PRODUCTS



Column Type Electric Power Steering
(CAT.No. E4102)



Pinion Type Electric Power Steering
(CAT.No. E4102)

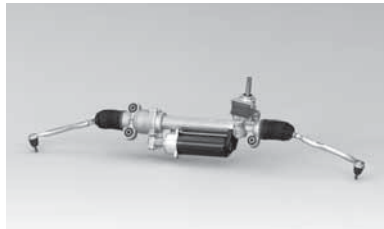

Offset Ball Screw Type Electric Power Steering
(CAT.No. E4102)



Long Life Water Pump Bearings
(CAT.No. E396, E4102)



Hub Unit Bearings
(CAT.No. E4201)



One-Way Clutch

PRECISION MACHINE COMPONENTS

BALL SCREWS



NSK Standard Ball Screws
Compact FA Series
(CAT. No. E3239, E3162)



NSK Standard Ball Screws
High Speed SS Series
(CAT.No.E3241)



High-Speed, Low-Noise Ball Screws
BSS Series
(CAT. No. E3162)

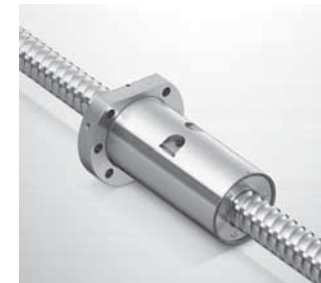

Ball Screws for High-Speed Machine Tools
HMD Series
(CAT. No. E3162)

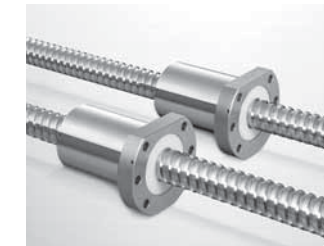

Ball Screws for Twin-Drive Systems
TW Series
(CAT. No. E3162)

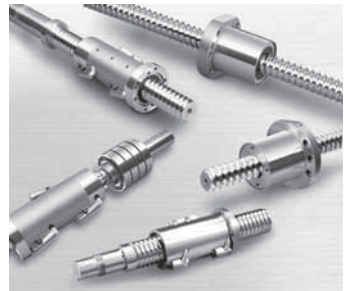

Ball Screws for High-Load Drive
HTF-SRC Series, HTF-SRD Series,
HTF Series, A1 Series
(CAT. No. E3238, E3162)

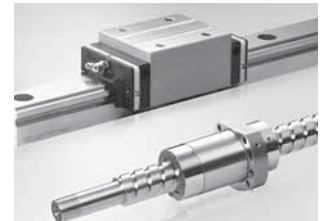

Highly Dust-Resistant Ball Screws,
NSK Linear Guides
V1 Series
(CAT. No. E3162)



Ball Screws, NSK Linear Guides with
NSK K1™ Lubrication Unit
(CAT. No. E3331, E3162)



Ball Screws, NSK Linear Guides
with E-DFO Thin-Film Lubrication for
Vacuum Environments
(CAT. No. E1258)

MONOCARRIERS



Monocarriers
(CAT. No. E3419, E3162)



Toughcarrier
(CAT. No. E3421)

PRECISION MACHINE COMPONENTS

LINEAR BEARINGS

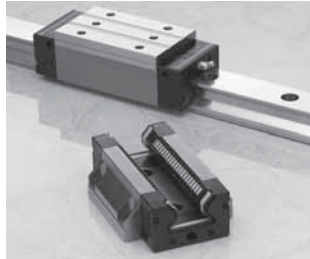

NSK Linear Guides
Roller Guides RA Series
(CAT. No. E3328, E3162)

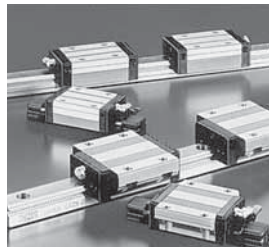

NSK Linear Guides
LH Series, LS Series
(CAT. No. E3162)



NSK Low-Noise Linear Guides
SH Series, SS Series
(CAT. No. E3162)

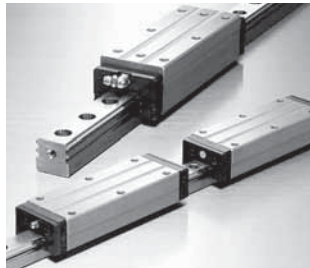

NSK Linear Guides
High-Accuracy Series
(CAT. No. E3329, E3162)

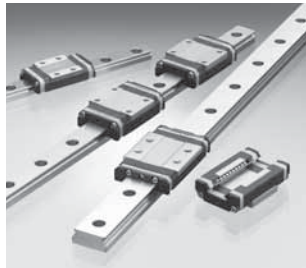

NSK Linear Guides
Miniature PU Series, PE Series
(CAT. No. E3327, E3162)

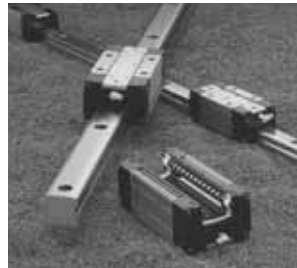

NSK Linear Guides
TS Series
(CAT. No. E3324, E3162)

ASSORTED SPINDLES

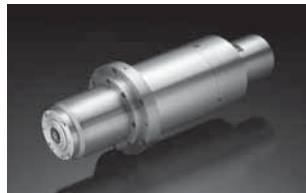

High Speed Integrated Motor Spindles



Precision Grinding
Spindles
(CAT.No. E2202)



Live Centers
(CAT.No. E2202)



Oil/Air Lubricating Unit,
Fine Lube
(CAT.No. E1254/A1387)



Standard Type Precision
Boring Heads
(CAT.No. E2202)



Spindles for Electrical and
Electric Equipment

PRECISION MACHINE COMPONENTS

MECHATRONIC ACTUATORS

Megatorque
Motor™
(CAT.No. E3511)



XY
Modules

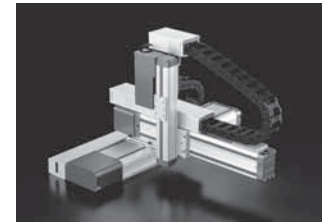

Megapositioner™



XY Tables

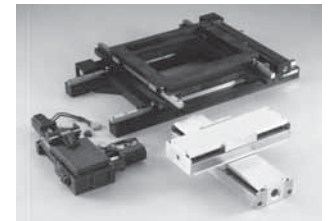

Positioning
Actuator™



Air Bearing
Slides

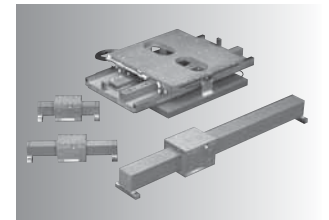

AIR SPINDLES



Air-spindle



Air Cleaner Unit

RELATED PRODUCT WITH BEARING

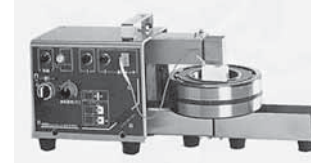
Bearing Induction Heater
(CAT.No. E398)Extra Small Bearing Monitor
NB-4
(Bearing Abnormality Detector)
(CAT.No. E410)

Large Size Proximity Stepper RZ Series



Appendix Table 1 Conversion Table from SI (International Units) System

Comparison of SI, CGS, and Engineering Units

Unit System	Units				Units					
	Length	Mass	Time	Temp.	Acceleration	Force	Stress	Pressure	Energy	Power
SI	m	kg	s	K, °C	m/s ²	N	Pa	Pa	J	W
CGS System	cm	g	s	°C	Gal	dyn	dyn/cm ²	dyn/cm ²	erg	erg/s
Engineering Unit System	m	kgf · s ² /m	s	°C	m/s ²	kgf	kgf/m ²	kgf/m ²	kgf · m	kgf · m/s

Prefixes Used In SI System

Multiples		Prefix	Symbols	Multiples		Prefix	Symbols
10 ¹⁸	10 ¹⁵	Exa	E	10 ⁻¹	Deci	d	
10 ¹²		Peta	P	10 ⁻²	Centi	c	
		Tera	T	10 ⁻³	Milli	m	
10 ⁹		Giga	G	10 ⁻⁶	Micro	μ	
10 ⁶		Mega	M	10 ⁻⁹	Nano	n	
10 ³		Kilo	k	10 ⁻¹²	Pico	p	
10 ²		Hecto	h	10 ⁻¹⁵	Femto	f	
10		Deca	da	10 ⁻¹⁸	Ato	a	

Conversion Factors from SI Units

Parameter	SI Units		Units other than SI		Conversion Factors from SI Units
	Names of Units	Symbols	Name of Units	Symbols	
Angle	Radian	rad	Degree Minute Second	° ' "	180/π 10 800/π 648 000/π
Length	Meter	m	Micron Angstrom	μ Å	10 ⁶ 10 ¹⁰
Area	Square meter	m ²	Are Hectare	a ha	10 ⁻² 10 ⁻⁴
Volume	Cubic meter	m ³	Liter Deciliter	l, L dl, dL	10 ³ 10 ⁴
Time	Second	s	Minute Hour Day	min h d	1/60 1/3 600 1/86 400
Frequency	Hertz	Hz	Cycle	s ⁻¹	1
Speed of Rotation	Revolution per second	s ⁻¹	Revolution per minute	rpm	60
Speed	Meter per second	m/s	Kilometer per hour Knot	km/h kn	3 600/1 000 3 600/1 852
Acceleration	Meter per second per second	m/s ²	Gal g	Gal G	10 ² 1/9.806 65
Mass	Kilogram	kg	Ton	t	10 ⁻³
Force	Newton	N	Kilogram-force Ton-force Dyne	kgf tf dyn	1/9.806 65 1/ (9.806 65×10 ³) 10 ⁵
Torque or Moment	Newton · meter	N · m	Kilogram-force meter	kgf · m	1/9.806 65
Stress	Pascal	Pa (N/m ²)	Kilogram-force per square centimeter Kilogram-force per square millimeter	kgf/cm ² kgf/mm ²	1/ (9.806 65×10 ⁴) 1/ (9.806 65×10 ⁶)

Conversion Factors from SI Units (Continued)

Parameter	SI Units		Units other than SI		Conversion Factors from SI Units
	Names of Units	Symbols	Names of Units	Units	
Pressure	Pascal (Newton per square meter)	Pa (N/m ²)	Kilogram-force per square meter Water Column Mercury Column Torr Bar Atmosphere	kgf/m ² mmH ₂ O mmHg Torr bar atm	1/9.806 65 1/ (9.806 65×10 ³) 760/ (1.013 25×10 ⁵) 760/ (1.013 25×10 ⁵) 10 ⁻⁵ 1/ (1.013 25×10 ⁵)
Energy	Joule (Newton · meter)	J (N · m)	Erg Calorie (International) Kilogram-force meter Kilowatt hour French horse power hour	erg cal _{IT} kgf · m kW · h PS · h	10 ⁷ 1/4.186 8 1/9.806 65 1/ (3.6×10 ⁶) ≈ 3.776 72×10 ⁻⁷
Work	Watt (Joule per second)	W (J/s)	Kilogram-force meter per second Kilocalorie per hour French horse power	kgf · m/s kcal/h PS	1/9.806 65 1/1.163 ≈ 1/735.498 8
Viscosity, Viscosity Index	Pascal second	Pa · s	Poise	P	10
Kinematic Viscosity, Kinematic Viscosity Index	Square meter per second	m ² /s	Stokes Centistokes	St cSt	10 ⁴ 10 ⁶
Temperature	Kelvin, Degree celsius	K, °C	Degree	°C	(See note (1))
Electric Current, Magnetomotive Force	Ampere	A	Ampere	A	1
Voltage, Electromotive Force	Volt	V	(Watts per ampere)	(W/A)	1
Magnetic Field Strength	Ampere per meter	A/m	Oersted	Oe	4π/10 ³
Magnetic Flux Density	Tesla	T	Gauss Gamma	Gs γ	10 ⁴ 10 ⁹
Electrical Resistance	Ohm	Ω	(Volts per ampere)	(V/A)	1

Note (1) The conversion from T K into θ °C is $\theta = T - 273.15$ but for a temperature difference, it is $\Delta T = \Delta \theta$. However, ΔT and $\Delta \theta$ represent temperature differences measured using the Kelvin and Celsius scales respectively.

Remarks The names and symbols in () are equivalent to those directly above them or on their left.
Example of conversion 1N=1/9.806 65kgf

Appendix Table 2 N-kgf Conversion Table

[Method of using this table] For example, to convert 10N into kgf, read the figure in the right kgf column adjacent to the 10 in the center column in the 1st block. This means that 10N is 1.0197kgf. To convert 10kgf into N, read the figure in the left N column of the same row, which indicates that the answer is 98.066N.

1 N=0.1019716 kgf
1 kgf=9.80665 N

N		kgf	N		kgf	N		kgf
9.8066	1	0.1020	333.43	34	3.4670	657.05	67	6.8321
19.613	2	0.2039	343.23	35	3.5690	666.85	68	6.9341
29.420	3	0.3059	353.04	36	3.6710	676.66	69	7.0360
39.227	4	0.4079	362.85	37	3.7729	686.47	70	7.1380
49.033	5	0.5099	372.65	38	3.8749	696.27	71	7.2400
58.840	6	0.6118	382.46	39	3.9769	706.08	72	7.3420
68.647	7	0.7138	392.27	40	4.0789	715.89	73	7.4439
78.453	8	0.8158	402.07	41	4.1808	725.69	74	7.5459
88.260	9	0.9177	411.88	42	4.2828	735.50	75	7.6479
98.066	10	1.0197	421.69	43	4.3848	745.31	76	7.7498
107.87	11	1.1217	431.49	44	4.4868	755.11	77	7.8518
117.68	12	1.2237	441.30	45	4.5887	764.92	78	7.9538
127.49	13	1.3256	451.11	46	4.6907	774.73	79	8.0558
137.29	14	1.4276	460.91	47	4.7927	784.53	80	8.1577
147.10	15	1.5296	470.72	48	4.8946	794.34	81	8.2597
156.91	16	1.6315	480.53	49	4.9966	804.15	82	8.3617
166.71	17	1.7335	490.33	50	5.0986	813.95	83	8.4636
176.52	18	1.8355	500.14	51	5.2006	823.76	84	8.5656
186.33	19	1.9375	509.95	52	5.3025	833.57	85	8.6676
196.13	20	2.0394	519.75	53	5.4045	843.37	86	8.7696
205.94	21	2.1414	529.56	54	5.5065	853.18	87	8.8715
215.75	22	2.2434	539.37	55	5.6084	862.99	88	8.9735
225.55	23	2.3453	549.17	56	5.7104	872.79	89	9.0755
235.36	24	2.4473	558.98	57	5.8124	882.60	90	9.1774
245.17	25	2.5493	568.79	58	5.9144	892.41	91	9.2794
254.97	26	2.6513	578.59	59	6.0163	902.21	92	9.3814
264.78	27	2.7532	588.40	60	6.1183	912.02	93	9.4834
274.59	28	2.8552	598.21	61	6.2203	921.83	94	9.5853
284.39	29	2.9572	608.01	62	6.3222	931.63	95	9.6873
294.20	30	3.0591	617.82	63	6.4242	941.44	96	9.7893
304.01	31	3.1611	627.63	64	6.5262	951.25	97	9.8912
313.81	32	3.2631	637.43	65	6.6282	961.05	98	9.9932
323.62	33	3.3651	647.24	66	6.7301	970.86	99	10.095

Appendix Table 3 kg-lb Conversion Table

[Method of using this table] For example, to convert 10kg into lb, read the figure in the right lb column adjacent to the 10 in the center column in the 1st block. This means that 10kg is 22.046lb. To convert 10lb into kg, read the figure in the left kg column of the same row, which indicates that the answer is 4.536kg.

1 kg=2.2046226 lb
1 lb=0.45359237 kg

kg		lb	kg		lb	kg		lb
0.454	1	2.205	15.422	34	74.957	30.391	67	147.71
0.907	2	4.409	15.876	35	77.162	30.844	68	149.91
1.361	3	6.614	16.329	36	79.366	31.298	69	152.12
1.814	4	8.818	16.783	37	81.571	31.751	70	154.32
2.268	5	11.023	17.237	38	83.776	32.205	71	156.53
2.722	6	13.228	17.690	39	85.980	32.659	72	158.73
3.175	7	15.432	18.144	40	88.185	33.112	73	160.94
3.629	8	17.637	18.597	41	90.390	33.566	74	163.14
4.082	9	19.842	19.051	42	92.594	34.019	75	165.35
4.536	10	22.046	19.504	43	94.799	34.473	76	167.55
4.990	11	24.251	19.958	44	97.003	34.927	77	169.76
5.443	12	26.455	20.412	45	99.208	35.380	78	171.96
5.897	13	28.660	20.865	46	101.41	35.834	79	174.17
6.350	14	30.865	21.319	47	103.62	36.287	80	176.37
6.804	15	33.069	21.772	48	105.82	36.741	81	178.57
7.257	16	35.274	22.226	49	108.03	37.195	82	180.78
7.711	17	37.479	22.680	50	110.23	37.648	83	182.98
8.165	18	39.683	23.133	51	112.44	38.102	84	185.19
8.618	19	41.888	23.587	52	114.64	38.555	85	187.39
9.072	20	44.092	24.040	53	116.84	39.009	86	189.60
9.525	21	46.297	24.494	54	119.05	39.463	87	191.80
9.979	22	48.502	24.948	55	121.25	39.916	88	194.01
10.433	23	50.706	25.401	56	123.46	40.370	89	196.21
10.886	24	52.911	25.855	57	125.66	40.823	90	198.42
11.340	25	55.116	26.308	58	127.87	41.277	91	200.62
11.793	26	57.320	26.762	59	130.07	41.730	92	202.83
12.247	27	59.525	27.216	60	132.28	42.184	93	205.03
12.701	28	61.729	27.669	61	134.48	42.638	94	207.23
13.154	29	63.934	28.123	62	136.69	43.091	95	209.44
13.608	30	66.139	28.576	63	138.89	43.545	96	211.64
14.061	31	68.343	29.030	64	141.10	43.998	97	213.85
14.515	32	70.548	29.484	65	143.30	44.452	98	216.05
14.969	33	72.753	29.937	66	145.51	44.906	99	218.26

Appendix Table 4 °C-°F Conversion Table

[Method of using this table] For example, to convert 38°C into °F, read the figure in the right °F column adjacent to the 38 in the center column in the 2nd block. This means that 38°C is 100.4°F. To convert 38°F into °C, read the figure in the left °C column of the same row, which indicates that the answer is 3.3°C.

$$C = \frac{5}{9}(F - 32)$$

$$F = 32 + \frac{9}{5}C$$

°C		°F	°C		°F	°C		°F	°C		°F
-73.3	-100	-148.0	0.0	32	89.6	21.7	71	159.8	43.3	110	230
-62.2	-80	-112.0	0.6	33	91.4	22.2	72	161.6	46.1	115	239
-51.1	-60	-76.0	1.1	34	93.2	22.8	73	163.4	48.9	120	248
-40.0	-40	-40.0	1.7	35	95.0	23.3	74	165.2	51.7	125	257
-34.4	-30	-22.0	2.2	36	96.8	23.9	75	167.0	54.4	130	266
-28.9	-20	-4.0	2.8	37	98.6	24.4	76	168.8	57.2	135	275
-23.3	-10	14.0	3.3	38	100.4	25.0	77	170.6	60.0	140	284
-17.8	0	32.0	3.9	39	102.2	25.6	78	172.4	65.6	150	302
-17.2	1	33.8	4.4	40	104.0	26.1	79	174.2	71.1	160	320
-16.7	2	35.6	5.0	41	105.8	26.7	80	176.0	76.7	170	338
-16.1	3	37.4	5.6	42	107.6	27.2	81	177.8	82.2	180	356
-15.6	4	39.2	6.1	43	109.4	27.8	82	179.6	87.8	190	374
-15.0	5	41.0	6.7	44	111.2	28.3	83	181.4	93.3	200	392
-14.4	6	42.8	7.2	45	113.0	28.9	84	183.2	98.9	210	410
-13.9	7	44.6	7.8	46	114.8	29.4	85	185.0	104.4	220	428
-13.3	8	46.4	8.3	47	116.6	30.0	86	186.8	110.0	230	446
-12.8	9	48.2	8.9	48	118.4	30.6	87	188.6	115.6	240	464
-12.2	10	50.0	9.4	49	120.2	31.1	88	190.4	121.1	250	482
-11.7	11	51.8	10.0	50	122.0	31.7	89	192.2	148.9	300	572
-11.1	12	53.6	10.6	51	123.8	32.2	90	194.0	176.7	350	662
-10.6	13	55.4	11.1	52	125.6	32.8	91	195.8	204	400	752
-10.0	14	57.2	11.7	53	127.4	33.3	92	197.6	232	450	842
-9.4	15	59.0	12.2	54	129.2	33.9	93	199.4	260	500	932
-8.9	16	60.8	12.8	55	131.0	34.4	94	201.2	288	550	1022
-8.3	17	62.6	13.3	56	132.8	35.0	95	203.0	316	600	1112
-7.8	18	64.4	13.9	57	134.6	35.6	96	204.8	343	650	1202
-7.2	19	66.2	14.4	58	136.4	36.1	97	206.6	371	700	1292
-6.7	20	68.0	15.0	59	138.2	36.7	98	208.4	399	750	1382
-6.1	21	69.8	15.6	60	140.0	37.2	99	210.2	427	800	1472
-5.6	22	71.6	16.1	61	141.8	37.8	100	212.0	454	850	1562
-5.0	23	73.4	16.7	62	143.6	38.3	101	213.8	482	900	1652
-4.4	24	75.2	17.2	63	145.4	38.9	102	215.6	510	950	1742
-3.9	25	77.0	17.8	64	147.2	39.4	103	217.4	538	1000	1832
-3.3	26	78.8	18.3	65	149.0	40.0	104	219.2	593	1100	2012
-2.8	27	80.6	18.9	66	150.8	40.6	105	221.0	649	1200	2192
-2.2	28	82.4	19.4	67	152.6	41.1	106	222.8	704	1300	2372
-1.7	29	84.2	20.0	68	154.4	41.7	107	224.6	760	1400	2552
-1.1	30	86.0	20.6	69	156.2	42.2	108	226.4	816	1500	2732
-0.6	31	87.8	21.1	70	158.0	42.8	109	228.2	871	1600	2912

Appendix Table 5 Viscosity Conversion Table

Kinematic Viscosity mm ² /s	Saybolt Universal SUS (sec)		No.1 Type Redwood R (sec)		Engler E (degree)	Kinematic Viscosity mm ² /s	Saybolt Universal SUS (sec)		No.1 Type Redwood R (sec)		Engler E (degree)
	100°F	210°F	50°C	100°C			100°F	210°F	50°C	100°C	
2	32.6	32.8	30.8	31.2	1.14	35	163	164	144	147	4.70
3	36.0	36.3	33.3	33.7	1.22	36	168	170	148	151	4.83
4	39.1	39.4	35.9	36.5	1.31	37	172	173	153	155	4.96
5	42.3	42.6	38.5	39.1	1.40	38	177	178	156	159	5.08
6	45.5	45.8	41.1	41.7	1.48	39	181	183	160	164	5.21
7	48.7	49.0	43.7	44.3	1.56	40	186	187	164	168	5.34
8	52.0	52.4	46.3	47.0	1.65	41	190	192	168	172	5.47
9	55.4	55.8	49.1	50.0	1.75	42	195	196	172	176	5.59
10	58.8	59.2	52.1	52.9	1.84	43	199	201	176	180	5.72
11	62.3	62.7	55.1	56.0	1.93	44	204	205	180	185	5.85
12	65.9	66.4	58.2	59.1	2.02	45	208	210	184	189	5.98
13	69.6	70.1	61.4	62.3	2.12	46	213	215	188	193	6.11
14	73.4	73.9	64.7	65.6	2.22	47	218	219	193	197	6.24
15	77.2	77.7	68.0	69.1	2.32	48	222	224	197	202	6.37
16	81.1	81.7	71.5	72.6	2.43	49	227	228	201	206	6.50
17	85.1	85.7	75.0	76.1	2.54	50	231	233	205	210	6.63
18	89.2	89.8	78.6	79.7	2.64	55	254	256	225	231	7.24
19	93.3	94.0	82.1	83.6	2.76	60	277	279	245	252	7.90
20	97.5	98.2	85.8	87.4	2.87	65	300	302	266	273	8.55
21	102	102	89.5	91.3	2.98	70	323	326	286	294	9.21
22	106	107	93.3	95.1	3.10	75	346	349	306	315	9.89
23	110	111	97.1	98.9	3.22	80	371	373	326	336	10.5
24	115	115	101	103	3.34	85	394	397	347	357	11.2
25	119	120	105	107	3.46	90	417	420	367	378	11.8
26	123	124	109	111	3.58	95	440	443	387	399	12.5
27	128	129	112	115	3.70	100	464	467	408	420	13.2
28	132	133	116	119	3.82	120	556	560	490	504	15.8
29	137	138	120	123	3.95	140	649	653	571	588	18.4
30	141	142	124	127	4.07	160	742	747	653	672	21.1
31	145	146	128	131	4.20	180	834	840	734	757	23.7
32	150	150	132	135	4.32	200	927	933	816	841	26.3
33	154	155	136	139	4.45	250	1 159	1 167	1 020	1 051	32.9
34	159	160	140	143	4.57	300	1 391	1 400	1 224	1 241	39.5

Remarks 1mm²/s=1cSt

Appendix Table 6 inch - mm Conversion Table

1" = 25.4 mm

inch	0	1	2	3	4	5	6	7	8	9	10	
Fraction Decimal	mm											
0	0.00000	0.000	25.400	50.800	76.200	101.600	127.000	152.400	177.800	203.200	228.600	254.000
1/64	0.015625	0.397	25.797	51.197	76.597	101.997	127.397	152.797	178.197	203.597	228.997	254.397
1/32	0.031250	0.794	26.194	51.594	76.994	102.394	127.794	153.194	178.594	203.994	229.394	254.794
3/64	0.046875	1.191	26.591	51.991	77.391	102.791	128.191	153.591	178.991	204.391	229.791	255.191
1/16	0.062500	1.588	26.988	52.388	77.788	103.188	128.588	153.988	179.388	204.788	230.188	255.588
5/64	0.078125	1.984	27.384	52.784	78.184	103.584	128.984	154.384	179.784	205.184	230.584	255.984
3/32	0.093750	2.381	27.781	53.181	78.581	103.981	129.381	154.781	180.181	205.581	230.981	256.381
7/64	0.109375	2.778	28.178	53.578	78.978	104.378	129.778	155.178	180.578	205.978	231.378	256.778
1/8	0.125000	3.175	28.575	53.975	79.375	104.775	130.175	155.575	180.975	206.375	231.775	257.175
9/64	0.140625	3.572	28.972	54.372	79.772	105.172	130.572	155.972	181.372	206.772	232.172	257.572
5/32	0.156250	3.969	29.369	54.769	80.169	105.569	130.969	156.369	181.769	207.169	232.569	257.969
11/64	0.171875	4.366	29.766	55.166	80.566	105.966	131.366	156.766	182.166	207.566	232.966	258.366
3/16	0.187500	4.762	30.162	55.562	80.962	106.362	131.762	157.162	182.562	207.962	233.362	258.762
13/64	0.203125	5.159	30.559	55.959	81.359	106.759	132.159	157.559	182.959	208.359	233.759	259.159
7/32	0.218750	5.556	30.956	56.356	81.756	107.156	132.556	157.956	183.356	208.756	234.156	259.556
15/64	0.234375	5.953	31.353	56.753	82.153	107.553	132.953	158.353	183.753	209.153	234.553	259.953
1/4	0.250000	6.350	31.750	57.150	82.550	107.950	133.350	158.750	184.150	209.550	234.950	260.350
17/64	0.265625	6.747	32.147	57.547	82.947	108.347	133.747	159.147	184.547	209.947	235.347	260.747
9/32	0.281250	7.144	32.544	57.944	83.344	108.744	134.144	159.544	184.944	210.344	235.744	261.144
19/64	0.296875	7.541	32.941	58.341	83.741	109.141	134.541	159.941	185.341	210.741	236.141	261.541
5/16	0.312500	7.938	33.338	58.738	84.138	109.538	134.938	160.338	185.738	211.138	236.538	261.938
21/64	0.328125	8.334	33.734	59.134	84.534	109.934	135.334	160.734	186.134	211.534	236.934	262.334
11/32	0.343750	8.731	34.131	59.531	84.931	110.331	135.731	161.131	186.531	211.931	237.331	262.731
23/64	0.359375	9.128	34.528	59.928	85.328	110.728	136.128	161.528	186.928	212.328	237.728	263.128
3/8	0.375000	9.525	34.925	60.325	85.725	111.125	136.525	161.925	187.325	212.725	238.125	263.525
25/64	0.390625	9.922	35.322	60.722	86.122	111.522	136.922	162.322	187.722	213.122	238.522	263.922
13/32	0.406250	10.319	35.719	61.119	86.519	111.919	137.319	162.719	188.119	213.519	238.919	264.319
27/64	0.421875	10.716	36.116	61.516	86.916	112.316	137.716	163.116	188.516	213.916	239.316	264.716
7/16	0.437500	11.112	36.512	61.912	87.312	112.712	138.112	163.512	188.912	214.312	239.712	265.112
29/64	0.453125	11.509	36.909	62.309	87.709	113.109	138.509	163.909	189.309	214.709	240.109	265.509
15/32	0.468750	11.906	37.306	62.706	88.106	113.506	138.906	164.306	189.706	215.106	240.506	265.906
31/64	0.484375	12.303	37.703	63.103	88.503	113.903	139.303	164.703	190.103	215.503	240.903	266.303
1/2	0.500000	12.700	38.100	63.500	88.900	114.300	139.700	165.100	190.500	215.900	241.300	266.700
33/64	0.515625	13.097	38.497	63.897	89.297	114.697	140.097	165.497	190.897	216.297	241.697	267.097
17/32	0.531250	13.494	38.894	64.294	89.694	115.094	140.494	165.894	191.294	216.694	242.094	267.494
35/64	0.546875	13.891	39.291	64.691	90.091	115.491	140.891	166.291	191.691	217.091	242.491	267.891
9/16	0.562500	14.288	39.688	65.088	90.488	115.888	141.288	166.688	192.088	217.488	242.888	268.288
37/64	0.578125	14.684	40.084	65.484	90.884	116.284	141.684	167.084	192.484	217.884	243.284	268.684
19/32	0.593750	15.081	40.481	65.881	91.281	116.681	142.081	167.481	192.881	218.281	243.681	269.081
39/64	0.609375	15.478	40.878	66.278	91.678	117.078	142.478	167.878	193.278	218.678	244.078	269.478
5/8	0.625000	15.875	41.275	66.675	92.075	117.475	142.875	168.275	193.675	219.075	244.475	269.875
41/64	0.640625	16.272	41.672	67.072	92.472	117.872	143.272	168.672	194.072	219.472	244.872	270.272
21/32	0.656250	16.669	42.069	67.469	92.869	118.269	143.669	169.069	194.469	219.869	245.269	270.669
43/64	0.671875	17.066	42.466	67.866	93.266	118.666	144.066	169.466	194.866	220.266	245.666	271.066
11/16	0.687500	17.462	42.862	68.262	93.662	119.062	144.462	169.862	195.262	220.662	246.062	271.462
45/64	0.703125	17.859	43.259	68.659	94.059	119.459	144.859	170.259	195.659	221.059	246.459	271.859
23/32	0.718750	18.256	43.656	69.056	94.456	119.856	145.256	170.656	196.056	221.456	246.856	272.256
47/64	0.734375	18.653	44.053	69.453	94.853	120.253	145.653	171.053	196.453	221.853	247.253	272.653
3/4	0.750000	19.050	44.450	69.850	95.250	120.650	146.050	171.450	196.850	222.250	247.650	273.050
49/64	0.765625	19.447	44.847	70.247	95.647	121.047	146.447	171.847	197.247	222.647	248.047	273.447
25/32	0.781250	19.844	45.244	70.644	96.044	121.444	146.844	172.244	197.644	223.044	248.444	273.844
51/64	0.796875	20.241	45.641	71.041	96.441	121.841	147.241	172.641	198.041	223.441	248.841	274.241
13/16	0.812500	20.638	46.038	71.438	96.838	122.238	147.638	173.038	198.438	223.838	249.238	274.638
53/64	0.828125	21.034	46.434	71.834	97.234	122.634	148.034	173.434	198.834	224.234	249.634	275.034
27/32	0.843750	21.431	46.831	72.231	97.631	123.031	148.431	173.831	199.231	224.631	250.031	275.431
55/64	0.859375	21.828	47.228	72.628	98.028	123.428	148.828	174.228	199.628	225.028	250.428	275.828
7/8	0.875000	22.225	47.625	73.025	98.425	123.825	149.225	174.625	200.025	225.425	250.825	276.225
57/64	0.890625	22.622	48.022	73.422	98.822	124.222	149.622	175.022	200.422	225.822	251.222	276.622
29/32	0.906250	23.019	48.419	73.819	99.219	124.619	150.019	175.419	200.819	226.219	251.619	277.019
59/64	0.921875	23.416	48.816	74.216	99.616	125.016	150.416	175.816	201.216	226.616	252.016	277.416
15/16	0.937500	23.812	49.212	74.612	100.012	125.412	150.812	176.212	201.612	227.012	252.412	277.812
61/64	0.953125	24.209	49.609	75.009	100.409	125.809	151.209	176.609	202.009	227.409	252.809	278.209
31/32	0.968750	24.606	50.006	75.406	100.806	126.206	151.606	177.006	202.406	227.806	253.206	278.606
63/64	0.984375	25.003	50.403	75.803	101.203	126.603	152.003	177.403	202.803	228.203	253.603	279.003

1" = 25.4 mm

inch	11	12	13	14	15	16	17	18	19	20
Fraction Decimal	mm									
0	0.0000	279.400	304.800	330.						

Appendix Table 7 Hardness Conversion Table (Reference)

Rockwell C Scale Hardness (1 471N) {150kgf}	Vickers Hardness	Brinell Hardness		Rockwell Hardness		Shore Hardness
		Standard Ball	Tungsten Carbide Ball	A Scale	B Scale	
				Load _{588.4N} {60kgf} Brale Indenter	Load _{980.7N} {100kgf} 1.588 mm ^φ Ball (1/16in)	
68	940	—	—	85.6	—	97
67	900	—	—	85.0	—	95
66	865	—	—	84.5	—	92
65	832	—	739	83.9	—	91
64	800	—	722	83.4	—	88
63	772	—	705	82.8	—	87
62	746	—	688	82.3	—	85
61	720	—	670	81.8	—	83
60	697	—	654	81.2	—	81
59	674	—	634	80.7	—	80
58	653	—	615	80.1	—	78
57	633	—	595	79.6	—	76
56	613	—	577	79.0	—	75
55	595	—	560	78.5	—	74
54	577	—	543	78.0	—	72
53	560	—	525	77.4	—	71
52	544	500	512	76.8	—	69
51	528	487	496	76.3	—	68
50	513	475	481	75.9	—	67
49	498	464	469	75.2	—	66
48	484	451	455	74.7	—	64
47	471	442	443	74.1	—	63
46	458	432	432	73.6	—	62
45	446	421	421	73.1	—	60
44	434	409	409	72.5	—	58
43	423	400	400	72.0	—	57
42	412	390	390	71.5	—	56
41	402	381	381	70.9	—	55
40	392	371	371	70.4	—	54
39	382	362	362	69.9	—	52
38	372	353	353	69.4	—	51
37	363	344	344	68.9	—	50
36	354	336	336	68.4	(109.0)	49
35	345	327	327	67.9	(108.5)	48
34	336	319	319	67.4	(108.0)	47
33	327	311	311	66.8	(107.5)	46
32	318	301	301	66.3	(107.0)	44
31	310	294	294	65.8	(106.0)	43
30	302	286	286	65.3	(105.5)	42
29	294	279	279	64.7	(104.5)	41
28	286	271	271	64.3	(104.0)	41
27	279	264	264	63.8	(103.0)	40
26	272	258	258	63.3	(102.5)	38
25	266	253	253	62.8	(101.5)	38
24	260	247	247	62.4	(101.0)	37
23	254	243	243	62.0	100.0	36
22	248	237	237	61.5	99.0	35
21	243	231	231	61.0	98.5	35
20	238	226	226	60.5	97.8	34
(18)	230	219	219	—	96.7	33
(16)	222	212	212	—	95.5	32
(14)	213	203	203	—	93.9	31
(12)	204	194	194	—	92.3	29
(10)	196	187	187	—	90.7	28
(8)	188	179	179	—	89.5	27
(6)	180	171	171	—	87.1	26
(4)	173	165	165	—	85.5	25
(2)	166	158	158	—	83.5	24
(0)	160	152	152	—	81.7	24

Appendix Table 8 Physical and Mechanical Properties of Materials

Materials	Specific Gravity	Coefficient of Linear Expansion (0° to 100°C) (K ⁻¹)	Hardness (Brinell)	Young's modulus (MPa) {kgf/mm ² }	Tensile Strength (MPa) {kgf/mm ² }	Yield Point (MPa) {kgf/mm ² }	Elongation (%)
Bearing Steel (hardened)	7.83	12.5×10 ⁻⁶	650 to 740	208 000 {21 200}	1 570 to 1 960 {160 to 200}	—	—
Martensitic Stainless Steel SUS 440C	7.68	10.1×10 ⁻⁶	580	200 000 {20 400}	1 960 {200}	1 860 {190}	—
Mild Steel (C=0.12~0.20%)	7.86	11.6×10 ⁻⁶	100 to 130	206 000 {21 000}	373 to 471 {38 to 48}	216 to 294 {22 to 30}	24 to 36
Hard Steel (C=0.3~0.5%)	7.84	11.3×10 ⁻⁶	160 to 200	206 000 {21 000}	539 to 686 {55 to 70}	333 to 451 {34 to 46}	14 to 26
Austenitic Stainless Steel SUS 304	8.03	16.3×10 ⁻⁶	150	193 000 {19 700}	588 {60}	245 {25}	60
Cast Iron	Gray Iron FC200	7.3	10.4×10 ⁻⁶	223	98 100 {10 000}	More than 200 {20}	—
	Spheroidal graphite Iron FCD400	7.0	11.7×10 ⁻⁶	Less than 201		More than 400 {41}	—
Aluminum	2.69	23.7×10 ⁻⁶	15 to 26	70 600 {7 200}	78 {8}	34 {3.5}	35
Zinc	7.14	31×10 ⁻⁶	30 to 60	92 200 {9 400}	147 {15}	—	30 to 40
Copper	8.93	16.2×10 ⁻⁶	50	123 000 {12 500}	196 {20}	69 {7}	15 to 20
Brass	(Annealed)	8.5	19.1×10 ⁻⁶	103 000 {10 500}	294 to 343 {30 to 35}	—	65 to 75
	(Machined)				85 to 130	363 to 539 {37 to 55}	—

Remarks The hardness of hardened bearing steel and martensitic stainless steel is usually expressed using the Rockwell C Scale, but for comparison, it is converted into Brinell hardness.

Appendix Table 9 Tolerances

Diameter Classification (mm)		Single Plane Mean & D. Deviation (Normal) Δ_{dmp}	d6	e6	f6	g5	g6	h5	h6	h7	h8	h9	h10	js5	js6
over	incl.														
3	6	0 - 8	- 30 - 38	- 20 - 28	- 10 - 18	- 4 - 4 - 9 - 12	0 - 5	0 - 8	0 - 12	0 - 18	0 - 30	0 - 48	± 2.5	± 4	
6	10	0 - 8	- 40 - 49	- 25 - 34	- 13 - 22	- 5 - 5 - 11 - 14	0 - 6	0 - 9	0 - 15	0 - 22	0 - 36	0 - 58	± 3	± 4.5	
10	18	0 - 8	- 50 - 61	- 32 - 43	- 16 - 27	- 6 - 6 - 14 - 17	0 - 8	0 - 11	0 - 18	0 - 27	0 - 43	0 - 70	± 4	± 5.5	
18	30	0 - 10	- 65 - 78	- 40 - 53	- 20 - 33	- 7 - 7 - 16 - 20	0 - 9	0 - 13	0 - 21	0 - 33	0 - 52	0 - 84	± 4.5	± 6.5	
30	50	0 - 12	- 80 - 96	- 50 - 66	- 25 - 41	- 9 - 9 - 20 - 25	0 - 11	0 - 16	0 - 25	0 - 39	0 - 62	0 - 100	± 5.5	± 8	
50	80	0 - 15	- 100 - 119	- 60 - 79	- 30 - 49	- 10 - 10 - 23 - 29	0 - 13	0 - 19	0 - 30	0 - 46	0 - 74	0 - 120	± 6.5	± 9.5	
80	120	0 - 20	- 120 - 142	- 72 - 94	- 36 - 58	- 12 - 12 - 27 - 34	0 - 15	0 - 22	0 - 35	0 - 54	0 - 87	0 - 140	± 7.5	± 11	
120	180	0 - 25	- 145 - 170	- 85 - 110	- 43 - 68	- 14 - 14 - 32 - 39	0 - 18	0 - 25	0 - 40	0 - 63	0 - 100	0 - 160	± 9	± 12.5	
180	250	0 - 30	- 170 - 199	- 100 - 129	- 50 - 79	- 15 - 15 - 35 - 44	0 - 20	0 - 29	0 - 46	0 - 72	0 - 115	0 - 185	± 10	± 14.5	
250	315	0 - 35	- 190 - 222	- 110 - 142	- 56 - 88	- 17 - 17 - 40 - 49	0 - 23	0 - 32	0 - 52	0 - 81	0 - 130	0 - 210	± 11.5	± 16	
315	400	0 - 40	- 210 - 246	- 125 - 161	- 62 - 98	- 18 - 18 - 43 - 54	0 - 25	0 - 36	0 - 57	0 - 89	0 - 140	0 - 230	± 12.5	± 18	
400	500	0 - 45	- 230 - 270	- 135 - 175	- 68 - 108	- 20 - 20 - 47 - 60	0 - 27	0 - 40	0 - 63	0 - 97	0 - 155	0 - 250	± 13.5	± 20	
500	630	0 - 50	- 260 - 304	- 145 - 189	- 76 - 120	- - 22 - - 66	- - 44	0 - 70	0 - 110	0 - 175	0 - 280	-	± 22		
630	800	0 - 75	- 290 - 340	- 160 - 210	- 80 - 130	- - 24 - - 74	- - 50	0 - 80	0 - 125	0 - 200	0 - 320	-	± 25		
800	1 000	0 - 100	- 320 - 376	- 170 - 226	- 86 - 142	- - 26 - - 82	- - 56	0 - 90	0 - 140	0 - 230	0 - 360	-	± 28		
1 000	1 250	0 - 125	- 350 - 416	- 195 - 261	- 98 - 164	- - 28 - - 94	- - 66	0 - 105	0 - 165	0 - 260	0 - 420	-	± 33		
1 250	1 600	0 - 160	- 390 - 468	- 220 - 298	- 110 - 188	- - 30 - - 108	- - 78	0 - 125	0 - 195	0 - 310	0 - 500	-	± 39		
1 600	2 000	0 - 200	- 430 - 522	- 240 - 332	- 120 - 212	- - 32 - - 124	- - 92	0 - 150	0 - 230	0 - 370	0 - 600	-	± 46		

for Shaft Diameters

Units : μm

j5	j6	j7	k5	k6	k7	m5	m6	n6	p6	r6	r7	Diameter Classification (mm)	
												over	incl.
+ 3 - 2	+ 6 - 2	+ 8 - 4	+ 6 + 1	+ 9 + 1	+ 13 + 1	+ 9 + 4	+ 12 + 4	+ 16 + 8	+ 20 + 12	+ 23 + 15	+ 27 + 15	3	6
+ 4 - 2	+ 7 - 2	+ 10 - 5	+ 7 + 1	+ 10 + 1	+ 16 + 1	+ 12 + 6	+ 15 + 6	+ 19 + 10	+ 24 + 15	+ 28 + 19	+ 34 + 19	6	10
+ 5 - 3	+ 8 - 3	+ 12 - 6	+ 9 + 1	+ 12 + 1	+ 19 + 1	+ 15 + 7	+ 18 + 7	+ 23 + 12	+ 29 + 18	+ 34 + 23	+ 41 + 21	10	18
+ 5 - 4	+ 9 - 4	+ 13 - 8	+ 11 + 2	+ 15 + 2	+ 23 + 2	+ 17 + 8	+ 21 + 8	+ 28 + 15	+ 35 + 22	+ 41 + 28	+ 49 + 28	18	30
+ 6 - 5	+ 11 - 5	+ 15 - 10	+ 13 + 2	+ 18 + 2	+ 27 + 2	+ 20 + 9	+ 25 + 9	+ 33 + 17	+ 42 + 26	+ 50 + 34	+ 59 + 34	30	50
+ 6 - 7	+ 12 - 7	+ 18 - 12	+ 15 + 2	+ 21 + 2	+ 32 + 2	+ 24 + 11	+ 30 + 11	+ 39 + 20	+ 51 + 32	+ 60 + 41	+ 71 + 41	50	65
+ 6 - 9	+ 13 - 9	+ 20 - 15	+ 18 + 3	+ 25 + 3	+ 38 + 3	+ 28 + 13	+ 35 + 13	+ 45 + 23	+ 59 + 37	+ 73 + 51	+ 86 + 51	80	100
+ 7 - 11	+ 14 - 11	+ 22 - 18	+ 21 + 3	+ 28 + 3	+ 43 + 3	+ 33 + 15	+ 40 + 15	+ 52 + 27	+ 68 + 43	+ 88 + 63	+ 103 + 63	120	140
+ 7 - 13	+ 16 - 13	+ 25 - 21	+ 24 + 4	+ 33 + 4	+ 50 + 4	+ 37 + 17	+ 46 + 17	+ 60 + 31	+ 79 + 50	+ 109 + 80	+ 126 + 80	200	225
+ 7 - 16	± 16	± 26	+ 27 + 4	+ 36 + 4	+ 56 + 4	+ 43 + 20	+ 52 + 20	+ 66 + 34	+ 88 + 56	+ 126 + 94	+ 146 + 94	250	280
+ 7 - 18	± 18	+ 29 - 28	+ 29 + 4	+ 40 + 4	+ 61 + 4	+ 46 + 21	+ 57 + 21	+ 73 + 37	+ 98 + 62	+ 144 + 108	+ 165 + 108	315	355
+ 7 - 20	± 20	+ 31 - 32	+ 32 + 5	+ 45 + 5	+ 68 + 5	+ 50 + 23	+ 63 + 23	+ 80 + 40	+ 108 + 68	+ 166 + 126	+ 189 + 126	400	450
-	-	-	-	+ 44 0	+ 70 0	-	+ 70 + 26	+ 88 + 44	+ 122 + 78	+ 194 + 150	+ 220 + 150	500	560
-	-	-	-	+ 50 0	+ 80 0	-	+ 80 + 30	+ 100 + 50	+ 138 + 88	+ 225 + 175	+ 255 + 175	630	710
-	-	-	-	+ 56 0	+ 90 0	-	+ 90 + 34	+ 112 + 56	+ 156 + 100	+ 266 + 210	+ 300 + 210	800	900
-	-	-	-	+ 66 0	+ 105 0	-	+ 106 + 40	+ 132 + 66	+ 186 + 120	+ 316 + 250	+ 355 + 250	1 000	1 120
-	-	-	-	+ 78 0	+ 125 0	-	+ 126 + 48	+ 156 + 78	+ 218 + 140	+ 378 + 300	+ 425 + 300	1 250	1 400
-	-	-	-	+ 92 0	+ 150 0	-	+ 150 + 58	+ 184 + 92	+ 262 + 170	+ 462 + 370	+ 520 + 370	1 600	1 800
-	-	-	-			-				+ 492 + 400	+ 550 + 400	1 800	2 000

Appendix Table 10

Diameter Classification (mm)		Single Plane Mean O.D. Deviation (Normal) ΔD_{mp}	E6	F6	F7	G6	G7	H6	H7	H8	J6	J7	JS6	JS7
over	incl.													
10	18	0 - 8	+ 43 + 32	+ 27 + 16	+ 34 + 16	+ 17 + 6	+ 24 + 6	+ 11 0	+ 18 0	+ 27 0	+ 6 - 5	+ 10 - 8	± 5.5	± 9
18	30	0 - 9	+ 53 + 40	+ 33 + 20	+ 41 + 20	+ 20 + 7	+ 28 + 7	+ 13 0	+ 21 0	+ 33 0	+ 8 - 5	+ 12 - 9	± 6.5	± 10.5
30	50	0 - 11	+ 66 + 50	+ 41 + 25	+ 50 + 25	+ 25 + 9	+ 34 + 9	+ 16 0	+ 25 0	+ 39 0	+ 10 - 6	+ 14 - 11	± 8	± 12.5
50	80	0 - 13	+ 79 + 60	+ 49 + 30	+ 60 + 30	+ 29 + 10	+ 40 + 10	+ 19 0	+ 30 0	+ 46 0	+ 13 - 6	+ 18 - 12	± 9.5	± 15
80	120	0 - 15	+ 94 + 72	+ 58 + 36	+ 71 + 36	+ 34 + 12	+ 47 + 12	+ 22 0	+ 35 0	+ 54 0	+ 16 - 6	+ 22 - 13	± 11	± 17.5
120	150	0 - 18	+ 110 + 85	+ 68 + 43	+ 83 + 43	+ 39 + 14	+ 54 + 14	+ 25 0	+ 40 0	+ 63 0	+ 18 - 7	+ 26 - 14	± 12.5	± 20
150	180	0 - 25	+ 110 + 85	+ 68 + 43	+ 83 + 43	+ 39 + 14	+ 54 + 14	+ 25 0	+ 40 0	+ 63 0	+ 18 - 7	+ 26 - 14	± 12.5	± 20
180	250	0 - 30	+ 129 + 100	+ 79 + 50	+ 96 + 50	+ 44 + 15	+ 61 + 15	+ 29 0	+ 46 0	+ 72 0	+ 22 - 7	+ 30 - 16	± 14.5	± 23
250	315	0 - 35	+ 142 + 110	+ 88 + 56	+ 108 + 56	+ 49 + 17	+ 69 + 17	+ 32 0	+ 52 0	+ 81 0	+ 25 - 7	+ 36 - 16	± 16	± 26
315	400	0 - 40	+ 161 + 125	+ 98 + 62	+ 119 + 62	+ 54 + 18	+ 75 + 18	+ 36 0	+ 57 0	+ 89 0	+ 29 - 7	+ 39 - 18	± 18	± 28.5
400	500	0 - 45	+ 175 + 135	+ 108 + 68	+ 131 + 68	+ 60 + 20	+ 83 + 20	+ 40 0	+ 63 0	+ 97 0	+ 33 - 7	+ 43 - 20	± 20	± 31.5
500	630	0 - 50	+ 189 + 145	+ 120 + 76	+ 146 + 76	+ 66 + 22	+ 92 + 22	+ 44 0	+ 70 0	+ 110 0	—	—	± 22	± 35
630	800	0 - 75	+ 210 + 160	+ 130 + 80	+ 160 + 80	+ 74 + 24	+ 104 + 24	+ 50 0	+ 80 0	+ 125 0	—	—	± 25	± 40
800	1 000	0 - 100	+ 226 + 170	+ 142 + 86	+ 176 + 86	+ 82 + 26	+ 116 + 26	+ 56 0	+ 90 0	+ 140 0	—	—	± 28	± 45
1 000	1 250	0 - 125	+ 261 + 195	+ 164 + 98	+ 203 + 98	+ 94 + 28	+ 133 + 28	+ 66 0	+ 105 0	+ 165 0	—	—	± 33	± 52.5
1 250	1 600	0 - 160	+ 298 + 220	+ 188 + 110	+ 235 + 110	+ 108 + 30	+ 155 + 30	+ 78 0	+ 125 0	+ 195 0	—	—	± 39	± 62.5
1 600	2 000	0 - 200	+ 332 + 240	+ 212 + 120	+ 270 + 120	+ 124 + 32	+ 182 + 32	+ 92 0	+ 150 0	+ 230 0	—	—	± 46	± 75
2 000	2 500	0 - 250	+ 370 + 260	+ 240 + 130	+ 305 + 130	+ 144 + 34	+ 209 + 34	+ 110 0	+ 175 0	+ 280 0	—	—	± 55	± 87.5

Tolerances for Housing Bore Diameters

Units : μm

K5	K6	K7	M5	M6	M7	N5	N6	N7	P6	P7	Diameter Classification (mm)	
											over	incl.
+ 2 - 6	+ 2 - 9	+ 6 - 12	- 4 - 12	- 4 - 15	0 - 18	- 9 - 17	- 9 - 20	- 5 - 23	- 15 - 26	- 11 - 29	10	18
+ 1 - 8	+ 2 - 11	+ 6 - 15	- 5 - 14	- 4 - 17	0 - 21	- 12 - 21	- 11 - 24	- 7 - 28	- 18 - 31	- 14 - 35	18	30
+ 2 - 9	+ 3 - 13	+ 7 - 18	- 5 - 16	- 4 - 20	0 - 25	- 13 - 24	- 12 - 28	- 8 - 33	- 21 - 37	- 17 - 42	30	50
+ 3 - 10	+ 4 - 15	+ 9 - 21	- 6 - 19	- 5 - 24	0 - 30	- 15 - 28	- 14 - 33	- 9 - 39	- 26 - 45	- 21 - 51	50	80
+ 2 - 13	+ 4 - 18	+ 10 - 25	- 8 - 23	- 6 - 28	0 - 35	- 18 - 33	- 16 - 38	- 10 - 45	- 30 - 52	- 24 - 59	80	120
+ 3 - 15	+ 4 - 21	+ 12 - 28	- 9 - 27	- 8 - 33	0 - 40	- 21 - 39	- 20 - 45	- 12 - 52	- 36 - 61	- 28 - 68	120	180
+ 2 - 18	+ 5 - 24	+ 13 - 33	- 11 - 31	- 8 - 37	0 - 46	- 25 - 45	- 22 - 51	- 14 - 60	- 41 - 70	- 33 - 79	180	250
+ 3 - 20	+ 5 - 27	+ 16 - 36	- 13 - 36	- 9 - 41	0 - 52	- 27 - 50	- 25 - 57	- 14 - 66	- 47 - 79	- 36 - 88	250	315
+ 3 - 22	+ 7 - 29	+ 17 - 40	- 14 - 39	- 10 - 46	0 - 57	- 30 - 55	- 26 - 62	- 16 - 73	- 51 - 87	- 41 - 98	315	400
+ 2 - 25	+ 8 - 32	+ 18 - 45	- 16 - 43	- 10 - 50	0 - 63	- 33 - 60	- 27 - 67	- 17 - 80	- 55 - 95	- 45 - 108	400	500
—	0 - 44	0 - 70	—	- 26 - 70	- 26 - 96	—	- 44 - 88	- 44 - 114	- 78 - 122	- 78 - 148	500	630
—	0 - 50	0 - 80	—	- 30 - 80	- 30 - 110	—	- 50 - 100	- 50 - 130	- 88 - 138	- 88 - 168	630	800
—	0 - 56	0 - 90	—	- 34 - 90	- 34 - 124	—	- 56 - 112	- 56 - 146	- 100 - 156	- 100 - 190	800	1 000
—	0 - 66	0 - 105	—	- 40 - 106	- 40 - 145	—	- 66 - 132	- 66 - 171	- 120 - 186	- 120 - 225	1 000	1 250
—	0 - 78	0 - 125	—	- 48 - 126	- 48 - 173	—	- 78 - 156	- 78 - 203	- 140 - 218	- 140 - 265	1 250	1 600
—	0 - 92	0 - 150	—	- 58 - 150	- 58 - 208	—	- 92 - 184	- 92 - 242	- 170 - 262	- 170 - 320	1 600	2 000
—	0 - 110	0 - 175	—	- 68 - 178	- 68 - 243	—	- 110 - 220	- 110 - 285	- 195 - 305	- 195 - 370	2 000	2 500

Appendix Table 11 Values of

Basic Size (mm)		Standard										
		IT1	IT2	IT3	IT4	IT5	IT6	IT7	IT8	IT9	IT10	IT11
over	incl.	Tolerances (μm)										
—	3	0.8	1.2	2	3	4	6	10	14	25	40	60
3	6	1	1.5	2.5	4	5	8	12	18	30	48	75
6	10	1	1.5	2.5	4	6	9	15	22	36	58	90
10	18	1.2	2	3	5	8	11	18	27	43	70	110
18	30	1.5	2.5	4	6	9	13	21	33	52	84	130
30	50	1.5	2.5	4	7	11	16	25	39	62	100	160
50	80	2	3	5	8	13	19	30	46	74	120	190
80	120	2.5	4	6	10	15	22	35	54	87	140	220
120	180	3.5	5	8	12	18	25	40	63	100	160	250
180	250	4.5	7	10	14	20	29	46	72	115	185	290
250	315	6	8	12	16	23	32	52	81	130	210	320
315	400	7	9	13	18	25	36	57	89	140	230	360
400	500	8	10	15	20	27	40	63	97	155	250	400
500	630	9	11	16	22	32	44	70	110	175	280	440
630	800	10	13	18	25	36	50	80	125	200	320	500
800	1 000	11	15	21	28	40	56	90	140	230	360	560
1 000	1 250	13	18	24	33	47	66	105	165	260	420	660
1 250	1 600	15	21	29	39	55	78	125	195	310	500	780
1 600	2 000	18	25	35	46	65	92	150	230	370	600	920
2 000	2 500	22	30	41	55	78	110	175	280	440	700	1 100
2 500	3 150	26	36	50	68	96	135	210	330	540	860	1 350

- Remarks 1. Standard tolerance grades IT14 to IT18 shall not be used for basic sizes less than or equal to 1 mm.
2. Values for standard tolerance grades IT1 to IT5 for basic sizes over 500 mm are included for experimental use.

Standard Tolerance Grades IT

Grades							Basic Size (mm)	
IT12	IT13	IT14	IT15	IT16	IT17	IT18		
Tolerances (mm)							over	incl.
0.10	0.14	0.25	0.40	0.60	1.00	1.40	—	3
0.12	0.18	0.30	0.48	0.75	1.20	1.80	3	6
0.15	0.22	0.36	0.58	0.90	1.50	2.20	6	10
0.18	0.27	0.43	0.70	1.10	1.80	2.70	10	18
0.21	0.33	0.52	0.84	1.30	2.10	3.30	18	30
0.25	0.39	0.62	1.00	1.60	2.50	3.90	30	50
0.30	0.46	0.74	1.20	1.90	3.00	4.60	50	80
0.35	0.54	0.87	1.40	2.20	3.50	5.40	80	120
0.40	0.63	1.00	1.60	2.50	4.00	6.30	120	180
0.46	0.72	1.15	1.85	2.90	4.60	7.20	180	250
0.52	0.81	1.30	2.10	3.20	5.20	8.10	250	315
0.57	0.89	1.40	2.30	3.60	5.70	8.90	315	400
0.63	0.97	1.55	2.50	4.00	6.30	9.70	400	500
0.70	1.10	1.75	2.80	4.40	7.00	11.00	500	630
0.80	1.25	2.00	3.20	5.00	8.00	12.50	630	800
0.90	1.40	2.30	3.60	5.60	9.00	14.00	800	1 000
1.05	1.65	2.60	4.20	6.60	10.50	16.50	1 000	1 250
1.25	1.95	3.10	5.00	7.80	12.50	19.50	1 250	1 600
1.50	2.30	3.70	6.00	9.20	15.00	23.00	1 600	2 000
1.75	2.80	4.40	7.00	11.00	17.50	28.00	2 000	2 500
2.10	3.30	5.40	8.60	13.50	21.00	33.00	2 500	3 150

Appendix Table 12 Speed Factor f_n

Speed n (min ⁻¹)	Speed Factor f_n		Speed n (min ⁻¹)	Speed Factor f_n	
	Ball Bearings	Roller Bearings		Ball Bearings	Roller Bearings
10	1.49	1.44	180	0.570	0.603
11	1.45	1.39	190	0.560	0.593
12	1.41	1.36	200	0.550	0.584
13	1.37	1.33	220	0.533	0.568
14	1.34	1.30	240	0.518	0.553
15	1.30	1.27	260	0.504	0.540
16	1.28	1.25	280	0.492	0.528
17	1.25	1.22	300	0.481	0.517
18	1.23	1.20	320	0.471	0.507
19	1.21	1.18	340	0.461	0.498
20	1.19	1.17	360	0.452	0.490
21	1.17	1.15	380	0.444	0.482
22	1.15	1.13	400	0.437	0.475
23	1.13	1.12	420	0.430	0.468
24	1.12	1.10	440	0.423	0.461
25	1.10	1.09	460	0.417	0.455
26	1.09	1.08	480	0.411	0.449
27	1.07	1.07	500	0.405	0.444
28	1.06	1.05	550	0.393	0.431
29	1.05	1.04	600	0.382	0.420
30	1.04	1.03	650	0.372	0.410
31	1.02	1.02	700	0.362	0.401
32	1.01	1.01	750	0.354	0.393
33.3	1.00	1.00	800	0.347	0.385
34	0.993	0.994	850	0.340	0.378
36	0.975	0.977	900	0.333	0.372
38	0.957	0.961	950	0.327	0.366
40	0.941	0.947	1 000	0.322	0.360
42	0.926	0.933	1 050	0.317	0.355
44	0.912	0.920	1 100	0.312	0.350
46	0.898	0.908	1 150	0.307	0.346
48	0.886	0.896	1 200	0.303	0.341
50	0.874	0.885	1 250	0.299	0.337
55	0.846	0.861	1 300	0.295	0.333
60	0.822	0.838	1 400	0.288	0.326
65	0.800	0.818	1 500	0.281	0.319
70	0.781	0.800	1 600	0.275	0.313
75	0.763	0.784	1 700	0.270	0.307
80	0.747	0.769	1 800	0.265	0.302
85	0.732	0.755	1 900	0.260	0.297
90	0.718	0.742	2 000	0.255	0.293
95	0.705	0.730	2 100	0.251	0.289
100	0.693	0.719	2 200	0.247	0.285
110	0.672	0.699	2 300	0.244	0.281
120	0.652	0.681	2 400	0.240	0.277
130	0.635	0.665	2 500	0.237	0.274
140	0.620	0.650	2 600	0.234	0.271
150	0.606	0.637	2 700	0.231	0.268
160	0.593	0.625	2 800	0.228	0.265
170	0.581	0.613	2 900	0.226	0.262

Ball Bearings $f_n = (0.03 n)^{-1/3}$
 Roller Bearings $f_n = (0.03 n)^{-3/10}$

Speed n (min ⁻¹)	Speed Factor f_n		Speed n (min ⁻¹)	Speed Factor f_n	
	Ball Bearings	Roller Bearings		Ball Bearings	Roller Bearings
3 000	0.223	0.259	4 000	0.203	0.238
3 200	0.218	0.254	4 200	0.199	0.234
3 400	0.214	0.250	4 400	0.196	0.231
3 600	0.210	0.245	4 600	0.194	0.228
3 800	0.206	0.242	4 800	0.191	0.225
5 000	0.188	0.222	6 000	0.177	0.211
5 200	0.186	0.220	6 200	0.175	0.209
5 400	0.183	0.217	6 400	0.173	0.207
5 600	0.181	0.215	6 600	0.172	0.205
5 800	0.179	0.213	6 800	0.170	0.203
7 000	0.168	0.201	7 000	0.168	0.201
7 200	0.167	0.199	7 200	0.167	0.199
7 400	0.165	0.198	7 400	0.165	0.198
7 600	0.164	0.196	7 600	0.164	0.196
7 800	0.162	0.195	7 800	0.162	0.195
8 000	0.161	0.193	8 000	0.161	0.193
8 500	0.158	0.190	8 500	0.158	0.190
9 000	0.155	0.186	9 000	0.155	0.186
9 500	0.152	0.183	9 500	0.152	0.183
10 000	0.149	0.181	10 000	0.149	0.181
11 000	0.145	0.176	11 000	0.145	0.176
12 000	0.141	0.171	12 000	0.141	0.171
13 000	0.137	0.167	13 000	0.137	0.167
14 000	0.134	0.163	14 000	0.134	0.163
15 000	0.130	0.160	15 000	0.130	0.160
16 000	0.128	0.157	16 000	0.128	0.157
17 000	0.125	0.154	17 000	0.125	0.154
18 000	0.123	0.151	18 000	0.123	0.151
19 000	0.121	0.149	19 000	0.121	0.149
20 000	0.119	0.147	20 000	0.119	0.147
22 000	0.115	0.143	22 000	0.115	0.143
24 000	0.112	0.139	24 000	0.112	0.139
26 000	0.109	0.136	26 000	0.109	0.136
28 000	0.106	0.133	28 000	0.106	0.133
30 000	0.104	0.130	30 000	0.104	0.130
32 000	0.101	0.127	32 000	0.101	0.127
34 000	0.099	0.125	34 000	0.099	0.125
36 000	0.097	0.123	36 000	0.097	0.123
38 000	0.096	0.121	38 000	0.096	0.121
40 000	0.094	0.119	40 000	0.094	0.119

Appendix Table 13 Fatigue Life Factor f_h and Fatigue Life $L \cdot L_h$

Ball Bearings $L = (C/P)^3 L_h = 500 f_h^3$
 Roller Bearings $L = (C/P)^{10/3} L_h = 500 f_h^{10/3}$

C/P or f_h	Ball Bearing Life		Roller Bearing Life		C/P or f_h	Ball Bearing Life		Roller Bearing Life	
	L (10 ⁶ rev)	L_h (h)	L (10 ⁶ rev)	L_h (h)		L (10 ⁶ rev)	L_h (h)	L (10 ⁶ rev)	L_h (h)
0.70	0.34	172	0.30	152	3.45	41.1	20 500	62.0	31 000
0.75	0.42	211	0.38	192	3.50	42.9	21 400	65.1	32 500
0.80	0.51	256	0.48	238	3.55	44.7	22 400	68.2	34 100
0.85	0.61	307	0.58	291	3.60	46.7	23 300	71.5	35 800
0.90	0.73	365	0.70	352	3.65	48.6	24 300	74.9	37 400
0.95	0.86	429	0.84	421	3.70	50.7	25 300	78.3	39 200
1.00	1.00	500	1.00	500	3.75	52.7	26 400	81.9	41 000
1.05	1.16	579	1.18	588	3.80	54.9	27 400	85.6	42 800
1.10	1.33	665	1.37	687	3.85	57.1	28 500	89.4	44 700
1.15	1.52	760	1.59	797	3.90	59.3	29 700	93.4	46 700
1.20	1.73	864	1.84	918	3.95	61.6	30 800	97.4	48 700
1.25	1.95	977	2.10	1 050	4.00	64.0	32 000	102	50 800
1.30	2.20	1 100	2.40	1 200	4.05	66.4	33 200	106	52 900
1.35	2.46	1 230	2.72	1 360	4.10	68.9	34 500	110	55 200
1.40	2.74	1 370	3.07	1 530	4.15	71.5	35 700	115	57 400
1.45	3.05	1 520	3.45	1 730	4.20	74.1	37 000	120	59 800
1.50	3.38	1 690	3.86	1 930	4.25	76.8	38 400	124	62 200
1.55	3.72	1 860	4.31	2 150	4.30	79.5	39 800	129	64 600
1.60	4.10	2 050	4.79	2 400	4.35	82.3	41 200	134	67 200
1.65	4.49	2 250	5.31	2 650	4.40	85.2	42 600	140	69 800
1.70	4.91	2 460	5.86	2 930	4.45	88.1	44 100	145	72 500
1.75	5.36	2 680	6.46	3 230	4.50	91.1	45 600	150	75 200
1.80	5.83	2 920	7.09	3 550	4.55	94.2	47 100	156	78 000
1.85	6.33	3 170	7.77	3 890	4.60	97.3	48 700	162	80 900
1.90	6.86	3 430	8.50	4 250	4.65	101	50 300	168	83 900
1.95	7.41	3 710	9.26	4 630	4.70	104	51 900	174	87 000
2.00	8.00	4 000	10.1	5 040	4.75	107	53 600	180	90 100
2.05	8.62	4 310	10.9	5 470	4.80	111	55 300	187	93 300
2.10	9.26	4 630	11.9	5 930	4.85	114	57 000	193	96 600
2.15	9.94	4 970	12.8	6 410	4.90	118	58 800	200	99 900
2.20	10.6	5 320	13.8	6 920	4.95	121	60 600	207	103 000
2.25	11.4	5 700	14.9	7 460	5.00	125	62 500	214	107 000
2.30	12.2	6 080	16.1	8 030	5.10	133	66 300	228	114 000
2.35	13.0	6 490	17.3	8 630	5.20	141	70 300	244	122 000
2.40	13.8	6 910	18.5	9 250	5.30	149	74 400	260	130 000
2.45	14.7	7 350	19.8	9 910	5.40	157	78 700	276	138 000
2.50	15.6	7 810	21.2	10 600	5.50	166	83 200	294	147 000
2.55	16.6	8 290	22.7	11 300	5.60	176	87 800	312	156 000
2.60	17.6	8 790	24.2	12 100	5.70	185	92 600	331	165 000
2.65	18.6	9 300	25.8	12 900	5.80	195	97 600	351	175 000
2.70	19.7	9 840	27.4	13 700	5.90	205	103 000	371	186 000
2.75	20.8	10 400	29.1	14 600	6.00	216	108 000	392	196 000
2.80	22.0	11 000	30.9	15 500	6.50	275	137 000	513	256 000
2.85	23.1	11 600	32.8	16 400	7.00	343	172 000	656	328 000
2.90	24.4	12 200	34.8	17 400	7.50	422	211 000	826	413 000
2.95	25.7	12 800	36.8	18 400	8.00	512	256 000	1 020	512 000
3.00	27.0	13 500	38.9	19 500	8.50	614	307 000	1 250	627 000
3.05	28.4	14 200	41.1	20 600	9.00	729	365 000	1 520	758 000
3.10	29.8	14 900	43.4	21 700	9.50	857	429 000	1 820	908 000
3.15	31.3	15 600	45.8	22 900	10.0	1 000	—	2 150	—
3.20	32.8	16 400	48.3	24 100	11.0	1 330	—	2 960	—
3.25	34.3	17 200	50.8	25 400	12.0	1 730	—	3 960	—
3.30	35.9	18 000	53.5	26 800	13.0	2 200	—	5 170	—
3.35	37.6	18 800	56.3	28 100	14.0	2 740	—	6 610	—
3.40	39.3	19 700	59.1	29 600	15.0	3 380	—	8 320	—

Appendix Table14 Index of Inch Design Tapered Roller Bearings

Bearing No. CONE, CUP	Nominal Dimension (mm) <i>d</i> :CONE (Bore Dia.) <i>D</i> :CUP (Outside Dia.)	Pages	Bearing No. CONE, CUP	Nominal Dimension (mm) <i>d</i> :CONE (Bore Dia.) <i>D</i> :CUP (Outside Dia.)	Pages	Bearing No. CONE, CUP	Nominal Dimension (mm) <i>d</i> :CONE (Bore Dia.) <i>D</i> :CUP (Outside Dia.)	Pages	Bearing No. CONE, CUP	Nominal Dimension (mm) <i>d</i> :CONE (Bore Dia.) <i>D</i> :CUP (Outside Dia.)	Pages
332	<i>D</i> 80.000	B140,B144,B146	497	<i>d</i> 85.725	B162	657	<i>d</i> 73.025	B158	1328	<i>D</i> 52.388	B136
336	<i>d</i> 41.275	B146	498	<i>d</i> 84.138	B162	658	<i>d</i> 74.612	B158	1329	<i>D</i> 53.975	B136
342	<i>d</i> 41.275	B146	522	<i>D</i> 101.600	B148,B150	659	<i>d</i> 76.200	B158	1380	<i>d</i> 22.225	B136
342 S	<i>d</i> 42.875	B146	528	<i>d</i> 47.625	B148	661	<i>d</i> 79.375	B160	1620	<i>D</i> 66.675	B142
344	<i>d</i> 40.000	B144	529	<i>d</i> 50.800	B150	663	<i>d</i> 82.550	B160	1680	<i>d</i> 33.338	B142
344 A	<i>d</i> 40.000	B144	529 X	<i>d</i> 50.800	B150	664	<i>d</i> 84.138	B162	1729	<i>D</i> 56.896	B136,B138
346	<i>d</i> 31.750	B140	532 X	<i>D</i> 107.950	B152	665	<i>d</i> 85.725	B162	1755	<i>d</i> 22.225	B136
354 A	<i>D</i> 85.000	B148	539	<i>d</i> 53.975	B152	665 A	<i>d</i> 85.725	B162	1779	<i>d</i> 23.812	B138
359 S	<i>d</i> 46.038	B148	552 A	<i>D</i> 123.825	B152,B154,B156	672	<i>D</i> 168.275	B162,B164,B166	1922	<i>D</i> 57.150	B138
362 A	<i>D</i> 88.900	B148,B150	553 X	<i>D</i> 122.238	B154,B156	677	<i>d</i> 85.725	B162	1988	<i>d</i> 28.575	B138
366	<i>d</i> 50.000	B150	555 S	<i>d</i> 57.150	B152	681	<i>d</i> 92.075	B164	1997 X	<i>d</i> 26.988	B138
368	<i>d</i> 50.800	B150	557 S	<i>d</i> 53.975	B152	683	<i>d</i> 95.250	B164	A2047	<i>d</i> 12.000	B136
368 A	<i>d</i> 50.800	B150	558	<i>d</i> 60.325	B154	685	<i>d</i> 98.425	B164	A2126	<i>D</i> 31.991	B136
369 A	<i>d</i> 47.625	B148	559	<i>d</i> 63.500	B154	2523	<i>d</i> 101.600	B166	2523	<i>D</i> 69.850	B140,B142
372	<i>D</i> 100.000	B150	560	<i>d</i> 66.675	B156	742	<i>D</i> 150.089	B156,B160,B162	2558	<i>d</i> 30.162	B140
374	<i>D</i> 93.264	B148	560 S	<i>d</i> 68.262	B156	743	<i>D</i> 150.000	B160	2559	<i>d</i> 30.162	B140
376	<i>d</i> 45.000	B148	563	<i>D</i> 127.000	B154,B156,B158	745 A	<i>d</i> 69.850	B156	2580	<i>d</i> 31.750	B140
377	<i>d</i> 52.388	B150	563 X	<i>D</i> 127.000	B156	749	<i>d</i> 85.026	B162	2582	<i>d</i> 31.750	B140
382	<i>D</i> 98.425	B152	565	<i>d</i> 63.500	B154	749 A	<i>d</i> 82.550	B160	2585	<i>d</i> 33.338	B142
382 A	<i>D</i> 96.838	B152	566	<i>d</i> 69.850	B156	749 S	<i>d</i> 85.026	B162	2631	<i>D</i> 66.421	B140
382 S	<i>D</i> 96.838	B152	567	<i>d</i> 73.025	B158	750	<i>d</i> 79.375	B160	2690	<i>d</i> 29.367	B140
385	<i>d</i> 55.000	B152	567 A	<i>d</i> 71.438	B158	752	<i>D</i> 161.925	B160,B162	2720	<i>D</i> 76.200	B144
387	<i>d</i> 57.150	B152	567 S	<i>d</i> 71.438	B158	753	<i>D</i> 168.275	B160,B162	2729	<i>D</i> 76.200	B144
387 A	<i>d</i> 57.150	B152	568	<i>d</i> 73.817	B158	757	<i>d</i> 82.550	B160	2735 X	<i>D</i> 73.025	B144
388 A	<i>d</i> 57.531	B152	569	<i>d</i> 64.963	B154	758	<i>d</i> 85.725	B162	2788	<i>d</i> 38.100	B144
390 A	<i>d</i> 63.500	B154	570	<i>d</i> 68.262	B156	759	<i>d</i> 88.900	B162	2789	<i>d</i> 39.688	B144
394 A	<i>D</i> 110.000	B154,B156	572	<i>D</i> 139.992	B158,B160	760	<i>d</i> 90.488	B162	2820	<i>D</i> 73.025	B142
395	<i>d</i> 63.500	B154	572 X	<i>D</i> 139.700	B160	766	<i>d</i> 88.900	B162	2877	<i>d</i> 34.925	B142
395 A	<i>d</i> 66.675	B156	575	<i>d</i> 76.200	B158	772	<i>D</i> 180.975	B164,B166	2924	<i>D</i> 85.000	B148
395 S	<i>d</i> 66.675	B156	580	<i>d</i> 82.550	B160	776	<i>d</i> 95.250	B164	2984	<i>d</i> 46.038	B148
397	<i>d</i> 60.000	B154	581	<i>d</i> 80.962	B160	779	<i>d</i> 98.425	B164	3120	<i>D</i> 72.626	B140,B142
399 A	<i>d</i> 68.262	B156	582	<i>d</i> 82.550	B160	780	<i>d</i> 101.600	B166	3188	<i>d</i> 31.750	B140
414	<i>D</i> 88.501	B144	590 A	<i>d</i> 76.200	B158	782	<i>d</i> 104.775	B166	3197	<i>d</i> 33.338	B142
418	<i>d</i> 38.100	B144	592	<i>D</i> 152.400	B164	787	<i>d</i> 104.775	B166	3320	<i>D</i> 80.167	B144
432	<i>D</i> 95.250	B146	592 A	<i>D</i> 152.400	B158,B162,B164	792	<i>D</i> 206.375	B168	3386	<i>d</i> 39.688	B144
432 A	<i>D</i> 95.250	B148	593	<i>d</i> 88.900	B162	795	<i>d</i> 120.650	B168	3420	<i>D</i> 79.375	B142,B144
436	<i>d</i> 46.038	B148	594	<i>d</i> 95.250	B164	797	<i>d</i> 130.000	B168	3478	<i>d</i> 34.925	B142
438	<i>d</i> 44.450	B146	596	<i>d</i> 85.725	B162	799	<i>d</i> 128.588	B168	3479	<i>d</i> 36.512	B144
453 A	<i>D</i> 107.950	B148	597	<i>d</i> 93.662	B164	799 A	<i>d</i> 130.175	B168	3490	<i>d</i> 38.100	B144
453 X	<i>D</i> 104.775	B152	598	<i>d</i> 92.075	B164	832	<i>D</i> 168.275	B160,B162	3525	<i>D</i> 87.312	B146
460	<i>d</i> 44.450	B148	598 A	<i>d</i> 92.075	B164	837	<i>d</i> 76.200	B160	3576	<i>d</i> 41.275	B146
462	<i>d</i> 57.150	B152	614 X	<i>D</i> 115.000	B152	842	<i>d</i> 82.550	B160	3578	<i>d</i> 44.450	B146
469	<i>d</i> 57.150	B152	622 X	<i>d</i> 55.000	B152	843	<i>d</i> 76.200	B160	3720	<i>D</i> 93.264	B146
472	<i>D</i> 120.000	B156,B158	632	<i>D</i> 136.525	B154,B158	850	<i>d</i> 88.900	B162	3730	<i>D</i> 93.264	B150
472 A	<i>D</i> 120.000	B156	633	<i>D</i> 130.175	B154,B156,B158	854	<i>D</i> 190.500	B162,B164,B166	3775	<i>d</i> 50.800	B150
478	<i>d</i> 65.000	B156	637	<i>d</i> 60.325	B154	855	<i>d</i> 88.900	B162	3780	<i>d</i> 50.800	B150
480	<i>d</i> 68.262	B156	639	<i>d</i> 63.500	B154	861	<i>d</i> 92.075	B164	3782	<i>d</i> 44.450	B146
484	<i>d</i> 70.000	B158	643	<i>d</i> 69.850	B156	864	<i>d</i> 95.250	B164	3820	<i>D</i> 85.725	B146
492 A	<i>D</i> 133.350	B160,B162	644	<i>d</i> 71.438	B158	866	<i>d</i> 98.425	B164	3877	<i>d</i> 41.275	B146
493	<i>D</i> 136.525	B158,B160,B162	645	<i>d</i> 71.438	B158	932	<i>D</i> 212.725	B166	3920	<i>D</i> 112.712	B154,B156
495	<i>d</i> 82.550	B160	652	<i>D</i> 152.400	B158,B160	938	<i>d</i> 114.300	B166	3926	<i>D</i> 112.712	B152,B154
495 A	<i>d</i> 76.200	B158	653	<i>D</i> 146.050	B156,B158,B160,B162	1220	<i>D</i> 57.150	B136	3981	<i>d</i> 58.738	B152
495 AX	<i>d</i> 76.200	B158	653 X	<i>D</i> 150.000	B158	1280	<i>d</i> 22.225	B136	3982	<i>d</i> 63.500	B154
496	<i>d</i> 80.962	B160	655	<i>d</i> 69.850	B156				3984	<i>d</i> 66.675	B156

Bearing No. CONE, CUP	Nominal Dimension (mm) <i>d</i> :CONE (Bore Dia.) <i>D</i> :CUP (Outside Dia.)	Pages
3994	<i>d</i> 66.675	B156
A4050	<i>d</i> 12.700	B136
A4059	<i>d</i> 15.000	B136
A4138	<i>D</i> 34.988	B136
4335	<i>D</i> 90.488	B146
4388	<i>d</i> 41.275	B146
4535	<i>D</i> 104.775	B152
4595	<i>d</i> 53.975	B152
A5069	<i>d</i> 17.455	B136
A5144	<i>D</i> 36.525	B136
5335	<i>D</i> 103.188	B148
5356	<i>d</i> 44.450	B148
5535	<i>D</i> 122.238	B152,B154
5566	<i>d</i> 55.562	B152
5582	<i>d</i> 60.325	B154
5584	<i>d</i> 63.500	B154
5735	<i>D</i> 135.733	B158,B160
5760	<i>d</i> 76.200	B158
5795	<i>d</i> 77.788	B160
A6062	<i>d</i> 15.875	B136
A6067	<i>d</i> 16.993	B136
A6075	<i>d</i> 19.050	B136
A6157	<i>D</i> 39.992	B136
6220	<i>D</i> 127.000	B150,B152
6279	<i>d</i> 50.800	B150
6280	<i>d</i> 53.975	B152
6320	<i>D</i> 135.755	B154,B156
6376	<i>d</i> 60.325	B154
6379	<i>d</i> 65.088	B156
6420	<i>D</i> 149.225	B152,B156,B158
6454	<i>d</i> 69.850	B156
6455	<i>d</i> 57.150	B152
6460	<i>d</i> 73.025	B158
6461	<i>d</i> 76.200	B158
6535	<i>D</i> 161.925	B158,B160,B162
6536	<i>D</i> 161.925	B158
6559	<i>d</i> 82.550	B160
6575	<i>d</i> 76.200	B158
6576	<i>d</i> 76.200	B158
6580	<i>d</i> 88.900	B162
9121	<i>D</i> 152.400	B154,B156
9180	<i>d</i> 61.912	B154
9185	<i>d</i> 68.262	B156
9220	<i>D</i> 161.925	B158
9285	<i>d</i> 76.200	B158
9320	<i>D</i> 177.800	B160
9321	<i>D</i> 171.450	B160,B162
9378	<i>d</i> 76.200	B160
9380	<i>d</i> 76.200	B160
9385	<i>d</i> 84.138	B162
02420	<i>D</i> 68.262	B138,B140
02473	<i>d</i> 25.400	B138
02474	<i>d</i> 28.575	B138
02475	<i>d</i> 31.750	B140

Bearing No. CONE, CUP	Nominal Dimension (mm) <i>d</i> :CONE (Bore Dia.) <i>D</i> :CUP (Outside Dia.)	Pages
02820	<i>D</i> 73.025	B138,B142
02872	<i>d</i> 28.575	B138
02878	<i>d</i> 34.925	B142
03062	<i>d</i> 15.875	B136
03162	<i>D</i> 41.275	B136
05062	<i>d</i> 15.875	B136
05068	<i>d</i> 17.462	B136
05075	<i>d</i> 19.050	B136
05079	<i>d</i> 19.990	B136
05175	<i>D</i> 44.450	B136
05185	<i>D</i> 47.000	B136
07079	<i>d</i> 20.000	B136
07087	<i>d</i> 22.225	B136
07097	<i>d</i> 25.000	B138
07098	<i>d</i> 24.981	B138
07100	<i>d</i> 25.400	B138
07100SA	<i>d</i> 25.400	B138
07196	<i>D</i> 50.005	B136,B138
07204	<i>D</i> 51.994	B136,B138
07205	<i>D</i> 52.001	B138
08118	<i>D</i> 30.162	B140
08125	<i>d</i> 31.750	B140
08231	<i>D</i> 58.738	B140
09062	<i>d</i> 15.875	B136
09067	<i>d</i> 19.050	B136
09074	<i>d</i> 19.050	B136
09078	<i>d</i> 19.050	B136
09081	<i>d</i> 20.625	B136
09194	<i>D</i> 49.225	B136
09195	<i>D</i> 49.225	B136
09196	<i>D</i> 49.225	B136
11162	<i>d</i> 41.275	B146
11300	<i>D</i> 76.200	B146
11520	<i>D</i> 42.862	B136
11590	<i>d</i> 15.875	B136
LM11710	<i>D</i> 39.878	B136
LM11749	<i>d</i> 17.462	B136
LM11910	<i>D</i> 45.237	B136
LM11949	<i>D</i> 19.050	B136
12168	<i>d</i> 42.862	B146
12303	<i>D</i> 76.992	B146
12520	<i>D</i> 49.225	B136
12580	<i>d</i> 20.638	B136
M12610	<i>D</i> 50.005	B136
M12648	<i>d</i> 22.225	B136
M12649	<i>d</i> 21.430	B136
LM12710	<i>D</i> 45.237	B136
LM12711	<i>D</i> 45.975	B136
LM12749	<i>d</i> 22.000	B136
13175	<i>d</i> 44.450	B146
13181	<i>d</i> 46.038	B148
13318	<i>D</i> 80.962	B146,B148
13620	<i>D</i> 69.012	B144
13621	<i>D</i> 69.012	B144

Bearing No. CONE, CUP	Nominal Dimension (mm) <i>d</i> :CONE (Bore Dia.) <i>D</i> :CUP (Outside Dia.)	Pages
13685	<i>d</i> 38.100	B144
19268	<i>D</i> 68.262	B144
13830	<i>D</i> 63.500	B144
13889	<i>d</i> 38.100	B144
14123 A	<i>d</i> 31.750	B140
14125 A	<i>d</i> 31.750	B140
14130	<i>d</i> 33.338	B142
14131	<i>d</i> 33.338	B142
14137 A	<i>d</i> 34.925	B142
14138 A	<i>d</i> 34.925	B142
14139	<i>d</i> 34.976	B142
14274	<i>D</i> 69.012	B140,B142
14276	<i>D</i> 69.012	B140,B142
14283	<i>D</i> 72.085	B142
15100	<i>d</i> 25.400	B138
15101	<i>d</i> 25.400	B138
15106	<i>d</i> 26.988	B138
15112	<i>d</i> 28.575	B138
15113	<i>d</i> 28.575	B138
15116	<i>d</i> 30.112	B140
15117	<i>d</i> 30.000	B140
15118	<i>d</i> 30.213	B140
15119	<i>d</i> 30.213	B140
15120	<i>d</i> 30.213	B140
15123	<i>d</i> 31.750	B140
15125	<i>d</i> 31.750	B140
15126	<i>d</i> 31.750	B140
15245	<i>D</i> 62.000	B138,B140
15250	<i>D</i> 63.500	B138
15250 X	<i>D</i> 63.500	B138
15520	<i>D</i> 57.150	B138
15523	<i>D</i> 60.325	B138
15578	<i>d</i> 25.400	B138
15580	<i>d</i> 26.988	B138
16150	<i>d</i> 38.100	B144
16284	<i>D</i> 72.238	B144
16929	<i>D</i> 74.988	B146
16986	<i>d</i> 43.000	B146
17098	<i>D</i> 24.981	B138
17118	<i>d</i> 30.000	B140
17244	<i>D</i> 62.000	B138,B140
17520	<i>D</i> 42.862	B136
17580	<i>d</i> 15.875	B136
17831	<i>D</i> 79.985	B148
17887	<i>d</i> 45.230	B148
18200	<i>d</i> 50.800	B150
18337	<i>D</i> 85.725	B150
18520	<i>D</i> 73.025	B144
18590	<i>d</i> 41.275	B144
18620	<i>D</i> 79.375	B148
18690	<i>d</i> 46.038	B148
18720	<i>D</i> 85.000	B150
18790	<i>d</i> 50.800	B150
19138	<i>d</i> 34.976	B142

Bearing No. CONE, CUP	Nominal Dimension (mm) <i>d</i> :CONE (Bore Dia.) <i>D</i> :CUP (Outside Dia.)	Pages
19150	<i>d</i> 38.100	B144
19268	<i>D</i> 68.262	B142,B144
21075	<i>d</i> 19.050	B136
21212	<i>D</i> 53.975	B136
L21511	<i>D</i> 34.988	B136
L21549	<i>d</i> 15.875	B136
22168	<i>d</i> 42.862	B146
22325	<i>D</i> 82.550	B146
23100	<i>D</i> 25.400	B138
23256	<i>D</i> 65.088	B138
23621	<i>D</i> 73.025	B142
23691	<i>d</i> 35.000	B142
24720	<i>D</i> 76.200	B146
24721	<i>D</i> 76.200	B146
24780	<i>d</i> 41.275	B146
25520	<i>D</i> 82.931	B146,B148
25521	<i>D</i> 83.058	B146
25523	<i>D</i> 82.931	B146,B148
25577	<i>d</i> 42.875	B146
25578	<i>d</i> 42.862	B146
25580	<i>d</i> 44.450	B146
25584	<i>d</i> 44.983	B148
25590	<i>D</i> 45.618	B148
25820	<i>D</i> 73.025	B142
25821	<i>D</i> 73.025	B142,B144
25877	<i>d</i> 34.925	B142
25878	<i>d</i> 34.925	B142
25880	<i>d</i> 36.487	B144
26118	<i>d</i> 30.000	B140
26131	<i>d</i> 33.338	B142
26283	<i>D</i> 72.000	B140,B142
26820	<i>D</i> 80.167	B146
26822	<i>D</i> 79.375	B146
26823	<i>D</i> 76.200	B146
26882	<i>d</i> 41.275	B146
26884	<i>d</i> 42.875	B146
27620	<i>D</i> 125.412	B160
27687	<i>d</i> 82.550	B160
27689	<i>d</i> 83.345	B160
27690	<i>d</i> 83.345	B160
27820	<i>D</i> 80.035	B144
27880	<i>d</i> 38.100	B144
28138	<i>d</i> 34.976	B142
28315	<i>D</i> 80.000	B142
28521	<i>D</i> 92.075	B150
28580	<i>d</i> 50.800	B150
28584	<i>d</i> 52.388	B150
28622	<i>D</i> 97.630	B152
28680	<i>d</i> 55.562	B152
28920	<i>D</i> 101.600	B154
28921	<i>D</i> 100.000	B154
28985	<i>d</i> 60.325	B154
29520	<i>D</i> 107.950	B154
29586	<i>d</i> 63.500	B154

Bearing No. CONE, CUP	Nominal Dimension (mm) <i>d</i> :CONE (Bore Dia.) <i>D</i> :CUP (Outside Dia.)	Pages
29620	<i>D</i> 112.712	B156, B158
29630	<i>D</i> 120.650	B156
29675	<i>d</i> 69.850	B156
29685	<i>d</i> 73.025	B158
LM29710	<i>D</i> 65.088	B144
LM29711	<i>D</i> 65.088	B144
LM29748	<i>d</i> 38.100	B144
LM29749	<i>D</i> 38.100	B144
31520	<i>D</i> 76.200	B142
31594	<i>d</i> 34.925	B142
33262	<i>d</i> 66.675	B156
33275	<i>d</i> 69.850	B156
33281	<i>d</i> 71.438	B158
33287	<i>d</i> 73.025	B158
JHM33410	<i>D</i> 55.000	B138
JHM33449	<i>d</i> 24.000	B138
33462	<i>D</i> 117.475	B156, B158
33821	<i>D</i> 95.250	B150
33889	<i>d</i> 50.800	B150
34300	<i>d</i> 76.200	B158
34306	<i>d</i> 77.788	B160
34478	<i>D</i> 121.442	B158, B160
36620	<i>D</i> 193.675	B168
36690	<i>d</i> 146.050	B168
36920	<i>D</i> 227.012	B170
36990	<i>d</i> 177.800	B170
37425	<i>d</i> 107.950	B166
37625	<i>D</i> 158.750	B166
M38510	<i>D</i> 66.675	B142
M38511	<i>D</i> 65.987	B142
M38547	<i>d</i> 35.000	B142
M38549	<i>d</i> 34.925	B142
39236	<i>d</i> 60.000	B154
39250	<i>d</i> 63.500	B154
39412	<i>D</i> 104.775	B154
39520	<i>D</i> 112.712	B154, B156
39521	<i>D</i> 112.712	B156
39585	<i>d</i> 63.500	B154
39590	<i>d</i> 66.675	B156
41100	<i>d</i> 25.400	B138
41125	<i>d</i> 28.575	B138
41126	<i>d</i> 28.575	B138
41286	<i>D</i> 72.626	B138
42350	<i>D</i> 88.900	B162
42362	<i>d</i> 92.075	B164
42368	<i>d</i> 93.662	B164
42375	<i>d</i> 95.250	B164
42376	<i>d</i> 95.250	B164
42381	<i>d</i> 96.838	B164
42584	<i>D</i> 148.430	B164
42587	<i>D</i> 149.225	B162, B164
42620	<i>D</i> 127.000	B158, B160
42687	<i>d</i> 76.200	B158
42688	<i>d</i> 76.200	B158

Bearing No. CONE, CUP	Nominal Dimension (mm) <i>d</i> :CONE (Bore Dia.) <i>D</i> :CUP (Outside Dia.)	Pages
42690	<i>d</i> 77.788	B160
43118	<i>d</i> 30.162	B140
43131	<i>d</i> 33.338	B142
43300	<i>D</i> 76.200	B140
43312	<i>D</i> 79.375	B142
44143	<i>D</i> 36.512	B144
44150	<i>d</i> 38.100	B144
44157	<i>d</i> 40.000	B144
44162	<i>d</i> 41.275	B146
44348	<i>D</i> 88.501	B144, B146
L44610	<i>D</i> 50.292	B138
L44640	<i>d</i> 23.812	B138
L44643	<i>d</i> 25.400	B138
L44649	<i>d</i> 26.988	B138
45220	<i>D</i> 104.775	B152
45221	<i>D</i> 104.775	B152
45289	<i>d</i> 57.150	B152
L45410	<i>D</i> 50.292	B140
L45449	<i>d</i> 29.000	B140
46143	<i>d</i> 36.512	B144
46162	<i>d</i> 41.275	B146
46176	<i>d</i> 44.450	B146
46368	<i>D</i> 93.662	B144, B146
46720	<i>D</i> 225.425	B168
46780	<i>d</i> 158.750	B168
47420	<i>D</i> 120.000	B156, B158
47487	<i>d</i> 69.850	B156
47490	<i>d</i> 71.438	B158
47620	<i>D</i> 133.350	B158, B160
47680	<i>d</i> 76.200	B158
47685	<i>d</i> 82.550	B160
47686	<i>d</i> 82.550	B160
47687	<i>d</i> 82.550	B160
47820	<i>D</i> 146.050	B164
47890	<i>d</i> 92.075	B164
47896	<i>d</i> 95.250	B164
48120	<i>D</i> 161.925	B166
48190	<i>D</i> 107.950	B166
48220	<i>D</i> 182.562	B168
48282	<i>d</i> 120.650	B168
48286	<i>d</i> 123.825	B168
48290	<i>d</i> 127.000	B168
48320	<i>D</i> 190.500	B168
48385	<i>d</i> 133.350	B168
48393	<i>d</i> 136.525	B168
LM48510	<i>D</i> 65.088	B142
LM48511	<i>D</i> 65.088	B142
LM48548	<i>d</i> 34.925	B142
48620	<i>D</i> 200.025	B168
48685	<i>d</i> 142.875	B168
49175	<i>d</i> 44.450	B146
49176	<i>d</i> 44.450	B146
49368	<i>D</i> 93.662	B146
49520	<i>D</i> 101.600	B150

Bearing No. CONE, CUP	Nominal Dimension (mm) <i>d</i> :CONE (Bore Dia.) <i>D</i> :CUP (Outside Dia.)	Pages
49585	<i>d</i> 50.800	B150
52387	<i>d</i> 98.425	B164
52393	<i>d</i> 100.012	B164
52400	<i>d</i> 101.600	B166
52618	<i>D</i> 157.162	B164, B166
52637	<i>D</i> 161.925	B164, B166
53150	<i>d</i> 38.100	B144
53162	<i>d</i> 41.275	B146
53176	<i>d</i> 44.450	B148
53177	<i>d</i> 44.450	B148
53178	<i>d</i> 44.450	B148
53375	<i>D</i> 95.250	B144, B148
53387	<i>D</i> 98.425	B146, B148
55175	<i>d</i> 44.450	B148
55187	<i>d</i> 47.625	B148
55200	<i>d</i> 50.800	B150
55200C	<i>d</i> 50.800	B150
55206	<i>d</i> 52.388	B150
55437	<i>D</i> 111.125	B148, B150
55443	<i>D</i> 112.712	B148
56418	<i>d</i> 106.362	B166
56425	<i>d</i> 107.950	B166
56650	<i>D</i> 165.100	B166
59200	<i>d</i> 50.800	B150
59429	<i>D</i> 108.966	B150
64433	<i>d</i> 109.992	B166
64450	<i>d</i> 114.300	B166
64700	<i>D</i> 177.800	B166
65200	<i>d</i> 50.800	B150
65212	<i>d</i> 53.975	B152
65237	<i>d</i> 60.325	B154
65320	<i>D</i> 114.300	B148
65385	<i>d</i> 44.450	B148
65500	<i>D</i> 127.000	B150, B152, B154
66187	<i>d</i> 47.625	B148
66462	<i>D</i> 117.475	B148
66520	<i>D</i> 122.238	B152, B154
66584	<i>d</i> 53.975	B152
66585	<i>d</i> 60.000	B154
66587	<i>d</i> 57.150	B152
LM67010	<i>D</i> 59.131	B138, B140
LM67043	<i>d</i> 28.575	B138
LM67048	<i>d</i> 31.750	B140
67320	<i>D</i> 203.200	B168
67322	<i>D</i> 196.850	B168
67388	<i>d</i> 127.000	B168
67389	<i>d</i> 130.175	B168
67390	<i>d</i> 133.350	B168
67720	<i>D</i> 247.650	B168, B170
67780	<i>d</i> 165.100	B168
67787	<i>d</i> 174.625	B170
67790	<i>d</i> 177.800	B170
67820	<i>D</i> 266.700	B170
67885	<i>d</i> 190.500	B170

Bearing No. CONE, CUP	Nominal Dimension (mm) <i>d</i> :CONE (Bore Dia.) <i>D</i> :CUP (Outside Dia.)	Pages
67920	<i>D</i> 282.575	B170
67983	<i>d</i> 203.200	B170
67985	<i>d</i> 206.375	B170
L68110	<i>D</i> 59.131	B142
L68111	<i>D</i> 59.975	B142
L68149	<i>d</i> 35.000	B142
68450	<i>d</i> 114.300	B166
68462	<i>d</i> 117.475	B166
68709	<i>D</i> 180.000	B166
68712	<i>D</i> 180.975	B166
JL69310	<i>D</i> 63.000	B144
JL69349	<i>d</i> 38.000	B144
71412	<i>d</i> 104.775	B166
71425	<i>d</i> 107.950	B166
71437	<i>d</i> 111.125	B166
71450	<i>d</i> 114.300	B166
71453	<i>d</i> 115.087	B166
71750	<i>D</i> 190.500	B166
72187	<i>d</i> 47.625	B148
72200	<i>d</i> 50.800	B150
72200C	<i>d</i> 50.800	B150
72212	<i>d</i> 53.975	B152
72212C	<i>d</i> 53.975	B152
72218	<i>d</i> 55.562	B152
72218C	<i>d</i> 55.562	B152
72225C	<i>d</i> 57.150	B152
72487	<i>D</i> 123.825	B148, B150, B152
LM72810	<i>D</i> 47.000	B138
LM72849	<i>d</i> 22.606	B138
74500	<i>d</i> 127.000	B168
74525	<i>d</i> 133.350	B168
74537	<i>d</i> 136.525	B168
74550	<i>d</i> 139.700	B168
74850	<i>D</i> 215.900	B168
74856	<i>D</i> 217.488	B168
77375	<i>d</i> 95.250	B164
77675	<i>D</i> 171.450	B164
78225	<i>d</i> 57.150	B152
78250	<i>d</i> 63.500	B154
LM78310	<i>D</i> 62.000	B142
LM78310A	<i>D</i> 62.000	B142
LM78349	<i>d</i> 35.000	B142
78537	<i>D</i> 136.525	B154
78551	<i>D</i> 140.030	B152, B154
78571	<i>D</i> 144.983	B152
HM81610	<i>D</i> 47.000	B136
HM81649	<i>d</i> 16.000	B136
M84210	<i>D</i> 59.530	B138
M84249	<i>d</i> 25.400	B138
M84510	<i>D</i> 57.150	B138
M84548	<i>d</i> 25.400	B138
M86610	<i>D</i> 64.292	B138, B140
M86643	<i>d</i> 25.400	B138
M86647	<i>d</i> 28.575	B138

Bearing No. CONE, CUP	Nominal Dimension (mm) <i>d</i> :CONE (Bore Dia.) <i>D</i> :CUP (Outside Dia.)	Pages
M86648A M86649 M88010	<i>d</i> 30.955 <i>d</i> 30.162 <i>D</i> 68.262	B140 B140 B140,B142
M88043 M88046 M88048	<i>d</i> 30.162 <i>d</i> 31.750 <i>d</i> 33.338	B140 B140 B142
HM88510 HM88542 HM88547	<i>D</i> 73.025 <i>d</i> 31.750 <i>d</i> 33.338	B140,B142 B140 B142
HM88610 HM88630 HM88638	<i>D</i> 72.233 <i>d</i> 25.400 <i>d</i> 32.000	B138,B140,B142,B144 B138 B140
HM88648 HM88649 HM89410	<i>d</i> 35.717 <i>d</i> 34.925 <i>D</i> 76.200	B144 B142 B142,B144
HM89411 HM89443 HM89444	<i>D</i> 76.200 <i>d</i> 33.338 <i>d</i> 33.338	B142 B142 B142
HM89446 HM89446A HM89449	<i>d</i> 34.925 <i>d</i> 34.925 <i>d</i> 36.512	B142 B142 B144
99100 99550 99575	<i>D</i> 254.000 <i>d</i> 139.700 <i>d</i> 146.050	B168 B168 B168
99587 99600 LM102910	<i>d</i> 149.225 <i>d</i> 152.400 <i>D</i> 73.431	B168 B168 B148
LM102949 JLM104910 LM104911	<i>d</i> 45.242 <i>D</i> 82.000 <i>D</i> 82.550	B148 B150 B150
LM104911A LM104912 LM104947A	<i>D</i> 82.550 <i>D</i> 82.931 <i>d</i> 50.000	B150 B150 B150
JLM104948 LM104949 M201011	<i>d</i> 50.000 <i>d</i> 50.800 <i>D</i> 73.025	B150 B150 B144
M201047 JM205110 JM205149	<i>d</i> 39.688 <i>D</i> 90.000 <i>d</i> 50.000	B144 B150 B150
JM207010 JM207049 JH211710	<i>D</i> 95.000 <i>d</i> 55.000 <i>D</i> 120.000	B152 B152 B156
JH211749 HM212010 HM212011	<i>d</i> 65.000 <i>D</i> 122.238 <i>D</i> 122.238	B156 B154,B156 B154,B156
HM212044 HM212046 HM212047	<i>d</i> 60.325 <i>d</i> 63.500 <i>d</i> 63.500	B154 B154 B154
HM212049 JH217210 JH217249	<i>d</i> 66.675 <i>D</i> 150.000 <i>d</i> 85.000	B156 B162 B162
HM218210 HM218248 HH221410	<i>D</i> 147.000 <i>d</i> 90.000 <i>D</i> 190.500	B162 B162 B162,B164,B166

Bearing No. CONE, CUP	Nominal Dimension (mm) <i>d</i> :CONE (Bore Dia.) <i>D</i> :CUP (Outside Dia.)	Pages
HH221432 HH221434 HH221440	<i>d</i> 87.312 <i>d</i> 88.900 <i>d</i> 95.250	B162 B162 B164
HH221442 HH221447 HH221449	<i>d</i> 98.425 <i>d</i> 99.982 <i>d</i> 101.600	B164 B164 B166
HH224310 HH224335 HH224340	<i>D</i> 212.725 <i>d</i> 101.600 <i>d</i> 107.950	B166 B166 B166
HH224346 M224710 M224748	<i>d</i> 114.300 <i>D</i> 174.625 <i>d</i> 120.000	B166 B168 B168
LL225710 LL225749 HM231110	<i>D</i> 165.895 <i>D</i> 127.000 <i>D</i> 236.538	B168 B168 B168
HM231140 M236810 M236849	<i>d</i> 146.050 <i>D</i> 260.350 <i>d</i> 177.800	B168 B170 B170
LM300811 LM300849 L305610	<i>D</i> 68.000 <i>d</i> 41.000 <i>D</i> 80.962	B144 B144 B150
L305649 JH307710 JH307749	<i>d</i> 50.800 <i>D</i> 110.000 <i>d</i> 55.000	B150 B152 B152
JHM318410 JHM318448 L327210	<i>D</i> 155.000 <i>d</i> 90.000 <i>D</i> 177.008	B162 B162 B168
L327249 LM328410 LM328448	<i>d</i> 133.350 <i>D</i> 187.325 <i>d</i> 139.700	B168 B168 B168
H414210 H414245 H414249	<i>D</i> 136.525 <i>d</i> 68.262 <i>d</i> 71.438	B156,B158 B156 B158
JH415610 JH415647 LM501310	<i>D</i> 145.000 <i>d</i> 75.000 <i>D</i> 73.431	B158 B158 B144
LM501314 LM501349 LM503310	<i>D</i> 73.431 <i>d</i> 41.275 <i>D</i> 75.000	B144 B144 B148
LM503349 HH506310 HH506348	<i>d</i> 46.000 <i>D</i> 114.300 <i>d</i> 49.212	B148 B150 B150
JLM506810 JLM506849 JLM508710	<i>D</i> 90.000 <i>d</i> 55.000 <i>D</i> 95.000	B152 B152 B154
JLM508748 JM511910 JM511946	<i>d</i> 60.000 <i>D</i> 110.000 <i>d</i> 65.000	B154 B156 B156
JM515610 JM515649 HM516410	<i>D</i> 130.000 <i>d</i> 80.000 <i>D</i> 133.350	B160 B160 B160
HM516448 JHM516810 JHM516849	<i>d</i> 82.550 <i>D</i> 140.000 <i>d</i> 85.000	B160 B162 B162

Bearing No. CONE, CUP	Nominal Dimension (mm) <i>d</i> :CONE (Bore Dia.) <i>D</i> :CUP (Outside Dia.)	Pages
HM518410 HM518445 LM522510	<i>D</i> 152.400 <i>D</i> 88.900 <i>D</i> 159.987	B162 B162 B166
LM522546 LM522548 LM522549	<i>d</i> 107.950 <i>d</i> 109.987 <i>d</i> 109.987	B166 B166 B166
JHM522610 JHM522649 JHM534110	<i>D</i> 180.000 <i>d</i> 110.000 <i>D</i> 230.000	B166 B166 B170
JHM534149 LM603011 LM603012	<i>d</i> 170.000 <i>D</i> 77.788 <i>D</i> 77.788	B170 B148 B148
LM603049 L610510 L610549	<i>d</i> 45.242 <i>D</i> 94.458 <i>d</i> 63.500	B148 B154 B154
JM612910 JM612949 LM613410	<i>D</i> 115.000 <i>d</i> 70.000 <i>D</i> 112.712	B158 B158 B156
LM613449 HM617010 HM617049	<i>d</i> 69.850 <i>D</i> 142.138 <i>d</i> 85.725	B156 B162 B162
L623110 L623149 JLM710910	<i>D</i> 152.400 <i>d</i> 114.300 <i>D</i> 105.000	B166 B166 B156
JLM710949 JLM714110 JLM714149	<i>d</i> 65.000 <i>D</i> 115.000 <i>d</i> 75.000	B156 B158 B158
JM714210 JM714249 H715311	<i>D</i> 120.000 <i>d</i> 75.000 <i>D</i> 136.525	B158 B158 B154,B156,B158
H715334 H715340 H715341	<i>d</i> 61.912 <i>d</i> 65.088 <i>d</i> 66.675	B154 B156 B156
H715343 H715345 JM716610	<i>d</i> 68.262 <i>d</i> 71.438 <i>D</i> 130.000	B156 B158 B162
JM716648 JM716649 JM718110	<i>d</i> 85.000 <i>d</i> 85.000 <i>D</i> 145.000	B162 B162 B162
JM718149 JM719113 JM719149	<i>d</i> 90.000 <i>D</i> 150.000 <i>d</i> 95.000	B162 B164 B164
JM720210 JHM720210 JM720249	<i>D</i> 155.000 <i>D</i> 160.000 <i>d</i> 100.000	B164 B164 B164
JHM720249 JL724314 JL724348	<i>d</i> 100.000 <i>D</i> 170.000 <i>d</i> 120.000	B164 B168 B168
JL725316 JL725346 JM734410	<i>D</i> 175.000 <i>D</i> 125.000 <i>D</i> 240.000	B168 B168 B170
JM734449 JM738210 JM738249	<i>d</i> 170.000 <i>D</i> 260.000 <i>d</i> 190.000	B170 B170 B170

Bearing No. CONE, CUP	Nominal Dimension (mm) <i>d</i> :CONE (Bore Dia.) <i>D</i> :CUP (Outside Dia.)	Pages
HM801310 HM801346 M802011	<i>D</i> 82.550 <i>d</i> 38.100 <i>D</i> 82.550	B144 B144 B146
M802048 HM803110 HM803145	<i>d</i> 41.275 <i>D</i> 88.900 <i>d</i> 41.275	B146 B146 B146
HM803146 HM803149 M804010	<i>d</i> 41.275 <i>d</i> 44.450 <i>D</i> 88.900	B146 B146 B148
M804049 HM804810 HM804840	<i>d</i> 47.625 <i>D</i> 95.250 <i>d</i> 41.275	B148 B146,B148,B150 B146
HM804843 HM804846 HM804848	<i>d</i> 44.450 <i>d</i> 47.625 <i>d</i> 48.412	B148 B148 B150
HM804849 HM807010 HM807011	<i>d</i> 48.412 <i>D</i> 104.775 <i>D</i> 104.775	B150 B148,B150 B150
JHM807012 HM807040 HM807044	<i>D</i> 105.000 <i>d</i> 44.450 <i>d</i> 49.212	B150 B148 B150
JHM807045 HM807046 JLM813010	<i>d</i> 50.000 <i>d</i> 50.800 <i>D</i> 110.000	B150 B150 B158
JLM813049 JLM820012 JLM820048	<i>d</i> 70.000 <i>D</i> 150.000 <i>d</i> 100.000	B158 B164 B164
JM822010 JM822049 JHM840410	<i>D</i> 165.000 <i>d</i> 110.000 <i>D</i> 300.000	B166 B166 B170
JHM840449 HM903210 HM903247	<i>d</i> 200.000 <i>D</i> 95.250 <i>d</i> 44.450	B170 B148 B148
HM903249 HM911210 HM911242	<i>d</i> 44.450 <i>D</i> 130.175 <i>d</i> 53.975	B148 B152 B152
H913810 H913842 H913849	<i>D</i> 146.050 <i>d</i> 61.912 <i>d</i> 69.850	B154,B156 B154 B156

Worldwide Sales Offices

P: Phone F: Fax ☆: Head Office

NSK LTD.-HEADQUARTERS, TOKYO, JAPAN

Nissel Bldg., 1-6-3 Ohsaki, Shinagawa-ku, Tokyo 141-8560, Japan
INDUSTRIAL MACHINERY BUSINESS DIVISION-HEADQUARTERS
P: +81-3-3779-7227 F: +81-3-3779-7644
AUTOMOTIVE BUSINESS DIVISION-HEADQUARTERS
P: +81-3-3779-7189 F: +81-3-3779-7917

●Africa

South Africa:

NSK SOUTH AFRICA (PTY) LTD.

25 Galaxy Avenue, Linbro Business Park, Sandton, Gauteng, P.O. Box 1157, Kelvin, 2054, South Africa
P: +27-11-458-3600 F: +27-11-458-3608

●Asia and Oceania

Australia:

NSK AUSTRALIA PTY. LTD.

MELBOURNE ☆ 11 Dalmore Drive, Scoresby, Victoria 3179, Australia
P: +61-3-9765-4400 F: +61-3-9764-8304
SYDNEY 24-29 River Road West, Parramatta, New South Wales 2150, Australia
P: +61-2-8843-8100 F: +61-2-8993-8406
BRISBANE 1/69 Selhurst Street, Coopers Plains, Queensland 4108, Australia
P: +61-7-3347-2600 F: +61-7-3345-5376
PERTH Unit 1, 71 Tacoma Circuit, Canning Vale, Western Australia 6155, Australia
P: +61-8-9256-5000 F: +61-8-9256-1044

New Zealand:

NSK NEW ZEALAND LTD.

AUCKLAND 3 Te Apunga Place, Mt. Wellington, Auckland, New Zealand
P: +64-9-276-4992 F: +64-9-276-4082

China:

NSK HONG KONG LTD.

HONG KONG ☆ Suite 705, 7th Floor, South Tower, World Finance Centre, Harbour City, T.S.T., Kowloon, Hong Kong, China
P: +852-2739-9933 F: +852-2739-9323
SHENZHEN Room 624-626, 6/F, Kerry Center, Reminman Road, Shenzhen, Guangdong, China
P: +86-755-25904886 F: +86-755-25904883

NSK (SHANGHAI) TRADING CO., LTD.

Room 8 NSK Rd., Huaqiao Economic Development Zone, Kunshan, Jiangsu, China (215332)
P: +86-512-5796-3000 F: +86-512-5796-3300

NSK (CHINA) INVESTMENT CO., LTD.

JIANGSU ☆ No.8 NSK Rd., Huaqiao Economic Development Zone, Kunshan, Jiangsu, China (215332)
P: +86-512-5796-3000 F: +86-512-5796-3300
BEIJING Room 2116, Beijing Fortune Bldg., 5 Dong San Huan Bei Lu, Chao Yang District, Beijing, China (100004)
P: +86-10-6590-8161 F: +86-10-6590-8166

TIAN JIN Room 06, 09F The Exchange Tower 2, No. 189 Nanjing Road, Heping District, Tianjin, China (300050)
P: +86-22-8319-5030 F: +86-22-8319-5033

CHANGCHUN Room 1001, Building A, Zhongyin Building, 727 Xi'an Road, Changchun, Jilin, China (130051)
P: +86-431-8898-8682 F: +86-431-8898-8670

SHENYANG Room 1101, China Resources Building, No. 286 Qingnian Street, Heping District, Shenyang Liaoning, China (110004)
P: +86-24-2334-2868 F: +86-24-2334-2058

DALIAN Room 1805 Xiwang Tower, No.136 Zhongshan Road, Zhongshan District, Dalian, Liaoning, China (116001)
P: +86-411-8800-8168 F: +86-411-8800-8160

NANJING Room A1 22F, Golden Eagle International Plaza, No.89 Hanzhong Road, Nanjing, Jiangsu, China (210029)
P: +86-25-8472-6671 F: +86-25-8472-6687

FUZHOU Room 1801-1811, B1#1A Class Office Building, Wanda Plaza, No.8 Aojiang Road, Fuzhou, China (350009)
P: +86-591-8380-1030 F: +86-591-8380-1225

WUHAN Room 2108, New World International Trade Tower I, No.568 Jianshe Road, Wuhan, Hubei, China (430003)
P: +86-27-8556-9630 F: +86-27-8556-9615

QINGDAO Room 802, Fangjory International Plaza, No.26 Xianggang Zhong Road, Shinan District, Qingdao, Shandong, China (266071)
P: +86-532-5568-3877 F: +86-532-5568-3876

GUANGZHOU Room 2302, TaiKoo Hui Tower 1, No.385 Tianhe Road, Tianhe District, Guangzhou, China (510620)
P: +86-20-3817-7800 F: +86-20-3786-4501

CHANGSHA Room 1048, 10/F, Zhongjian Plaza, No.766 WuyiRoad, Changsha, Hunan, China (410005)
P: +86-731-8571-3100 F: +86-731-8571-3255

LUOYANG Room 1108, Fangda Hotel, 6 XYuan Road, LuoYang HeNan, China (471003)
P: +86-379-6069-6188 F: +86-379-6069-6180

XI'AN Room 1007, B Changan Metropolis Center#8 Nanguanzheng Steet, Xi'an, Shanxi, China (710068)
P: +86-29-8765-1896 F: +86-29-8765-1895

CHONGQING Room 2306, Unit B, No.137, Keyuan 2nd Road, Jilulongpo District, Chongqing, China (400039)
P: +86-23-6806-5310 F: +86-23-6806-5292

CHENGDU Room1117, Lippo Tower, No.62 North Kehua Road, Chengdu, Sichuan, China (610041)
P: +86-28-8528-3690 F: +86-28-8528-3690

NSK CHINA SALES CO., LTD.

JIANGSU No.8 NSK Rd., Huaqiao Economic Development Zone, Kunshan, Jiangsu, China (215332)
P: +86-512-5796-3000 F: +86-512-5796-3300

India:

NSK INDIA SALES CO.PVT.LTD.

CHENNAI ☆ 6th Floor, Bannari Amman Towers, No.29 Dr. Radhakrishnan Salai, Mylapore, Chennai-600 004 Tamil Nadu, India
P: +91-44-2847-9600 F: +91-44-2847-9601

GURGAON Unit No.202, 2nd Floor, Block-A, Iris Tech Park, Sector-48, Sohna Road, Gurgaon-122018, Haryana, India
P: +91-124-4104-530 F: +91-124-4104-532

MUMBAI 321, 'A' Wing, Ahura Centre, 82, Mahakali Caves Road, Andheri (East), Mumbai -400 093, India
P: +91-22-2838-7787 F: +91-22-2838-5191

Indonesia:

PT. NSK INDONESIA

JAKARTA Summitras II, 6th Floor, Jl. Jend Sudirman Kav. 61-62, Jakarta 12190, Indonesia
P: +62-21-252-3458 F: +62-21-252-3223

Korea:

NSK KOREA CO., LTD.

SEOUL Posco Center (West Wing) 9F, 892, Daechi-dong, Kangnam-Ku, Seoul, 135-777, Korea
P: +82-2-3267-0300 F: +82-2-3267-0345

Malaysia:

NSK BEARINGS (MALAYSIA) SDN. BHD.

SHAH ALAM ☆ No. 2, Jalan Pemaju, U1/15, Seksyen U1, Hicom Glenmarie Industrial Park, 40150 Shah Alam, Selangor, Malaysia
P: +60-3-7803-8859 F: +60-3-7806-5982

PRAI No.36, Jalan kikik, Taman Inderawasih, 13600 Prai, Penang, Malaysia
P: +60-4-3902275 F: +60-4-3991830

JOHOR BAHRU 88 Jalan Ros Merah 2/17, Taman Johor Jaya, 81100 Johor Bahru, Johor, Malaysia
P: +60-7-3546290 F: +60-7-3546291

IPOH Gr. Floor, 89 Jalan Bendahara, 31650 Ipoh, Perak, Malaysia
P: +60-5-2555000 F: +60-5-2553373

Philippines:

NSK REPRESENTATIVE OFFICE

MANILA 6th Floor The Sateco Towers 169 H.V. dela Costa St., Sateco Village Makati City, Philippines 1227
P: +63-2-893-9543 F: +63-2-893-9173

Singapore:

NSK INTERNATIONAL (SINGAPORE) PTE LTD.

SINGAPORE 238A, Thomson Road, #24-01/05, Novena Square Tower A, Singapore 307684
P: +65-6496-8000 F: +65-6250-5845

NSK SINGAPORE (PRIVATE) LTD.

SINGAPORE 238A, Thomson Road, #24-01/05, Novena Square Tower A, Singapore 307684
P: +65-6496-8000 F: +65-6250-5845

Taiwan:

TAIWAN NSK PRECISION CO. LTD.

TAIPEI ☆ 11F, No.87, Song Jiang Rd., Jhongshan District, Taipei City 104, Taiwan R.O.C.
P: +886-2-2509-3305 F: +886-2-2509-1393

TAICHUNG 107-7, Sec. 3, Wen Xing Rd., Taichung City 407, Taiwan R.O.C.
P: +886-4-2311-7978 F: +886-4-2311-2627

TAINAN 5F, No.8, Daye 1st Rd., Southern Taiwan Science Park, Tainan City 741, Taiwan R.O.C.
P: +886-6-505-5861 F: +886-6-505-5061

TAIWAN NSK TECHNOLOGY CO., LTD.

TAIPEI ☆ 11F, No.87, Song Jiang Rd., Jhongshan District, Taipei City 104, Taiwan R.O.C.
P: +886-2-2509-3305 F: +886-2-2509-1393

TAICHUNG 10F-3, No.925, Sec.4, Taiwan Blvd., Xitun Dist., Taichung City 407, Taiwan R.O.C.
P: +886-4-2358-2945 F: +886-4-2358-7682

TAINAN 5F, No.8, Daye 1st Rd., Southern Taiwan Science Park, Tainan City 741, Taiwan R.O.C.
P: +886-6-505-5861 F: +886-6-505-5061

Thailand:

NSK BEARINGS (THAILAND) CO.,LTD.

BANGKOK 26 Soi Onmuh 55/1 Pravet Subdistrict, Pravat District, Bangkok 10250, Thailand
P: +66-2320-2555 F: +66-2320-2826

Vietnam:

NSK VIETNAM CO., LTD.

HANOI Techno Center, Room 204-205, Thang Long Industrial Park, Dong Anh District, Hanoi, Vietnam
P: +84-4-3955-0159 F: +84-4-3955-0158

NSK REPRESENTATIVE OFFICE

HO CHI MINH CITY Suite 307, Metropolltan Building, 235 Dong Khoi Street, District 1,HCMC, Vietnam
P: +84-8-3822-7907 F: +84-8-3822-7910

Worldwide Sales Offices

P: Phone F: Fax ☆: Head Office

●Europe

United Kingdom:

NSK EUROPE LTD. (EUROPEAN HEADQUARTERS)

MAIDENHEAD Belmont Place, Belmont Road, Maidenhead, Berkshire SL6 6TB, U.K.
P: +44-1628-509-800 F: +44-1628-509-808

NSK UK LTD.

NEWARK Northern Road, Newark, Nottinghamshire NG24 2JF, U.K.
P: +44-1636-605-123 F: +44-1636-605-000

France:

NSK FRANCE S.A.S.

PARIS Quartier de l'Europe, 2 Rue Georges Guynemer, 78283 Guyancourt, France
P: +33-1-30-57-39-39 F: +33-1-30-57-00-01

Germany:

NSK DEUTSCHLAND GMBH

DUSSELDORF ☆ Harkortstrasse 15, D-40880 Ratingen, Germany
P: +49-2102-4810 F: +49-2102-4812-290

STUTTGART Liebknechtstrasse 33, D-70565 Stuttgart-Vaihingen, Germany
P: +49-711-79082-0 F: +49-711-79082-289

WOLFSBURG Tischlerstrasse 3, D-38440 Wolfsburg, Germany
P: +49-5361-27647-10 F: +49-5361-27647-70

Italy:

NSK ITALIA S.P.A.

MILANO Via Garibaldi 215, Garbagnate Milanese (Milano) 20024, Italy
P: +39-299-5191 F: +39-299-025778

Netherlands:

NSK EUROPEAN DISTRIBUTION CENTRE B.V.

TILBURG De Kroonstraat 38, 5048 AP Tilburg, Netherlands
P: +31-13-4647647 F: +31-13-4647648

Poland:

NSK REPRESENTATIVE OFFICE

WARSAW Ul. Migdalowa 4/73, 02-796, Warsaw, Poland
P: +48-22-645-1525 F: +48-22-645-1529

Russia:

NSK POLSKA SP. Z O.O.

SAINT-PETERSBURG Office I 703, Bldg 29, 18th Line of Vasilievskiy Ostrov, Saint-Petersburg, Russia, 199178
P: +7-812-332-5071 F: +7-812-332-5072

Spain:

NSK SPAIN S.A.

BARCELONA C/Tarragona 161, 2a Planta, 08014, Barcelona, Spain
P: +34-93-433-5775 F: +34-93-433-5776

Turkey:

NSK RULMANLARI ORTA DOGU TIC. LTD. STI.

ISTANBUL 19 Mayıs Mah. Ataturk Cad. Ulya Engin Is Mrk. 68/3 Kat:6 34736, Kozyatagi/Istanbul, Turkey
P: +90-216-477-7111 F: +90-216-477-7174

UAE:

NSK BEARINGS GULF TRADING CO.

DUBAI JAFZA View 19, Floor 24 Office 2/3 Jebel Ali Downtown, PO Box 262163, Dubai, UAE
P: +971-4-804-8200 F: +971-4-884-7227

●North and South America

United States of America:

NSK AMERICAS, INC. (AMERICAN HEADQUARTERS)

ANN ARBOR 4200 Goss Road, Ann Arbor, Michigan 48105, U.S.A.
P: +1-734-913-7500 F: +1-734-913-7511

NSK CORPORATION

ANN ARBOR 4200 Goss Road, Ann Arbor, Michigan 48105, U.S.A.
P: +1-734-913-7500 F: +1-734-913-7511

NSK PRECISION AMERICA, INC.

FRANKLIN ☆ 3450 Bearing Drive, Franklin, Indiana 46131, U.S.A.
P: +1-317-738-5000 F: +1-317-738-5050

SAN JOSE 780 Montague Expressway, Suite 508, San Jose, California 95131, U.S.A.
P: +1-408-944-9400 F: +1-408-944-9405

NSK LATIN AMERICA, INC.

MIAMI 2500 NW 107th Avenue, Suite 300, Miami, Florida 33172, U.S.A.
P: +1-305-477-0605 F: +1-305-477-0377

Canada:

NSK CANADA INC.

TORONTO ☆ 5585 McAdam Road, Mississauga, Ontario, Canada L4Z 1N4
P: +1-905-890-0740 F: +1-800-800-2788

MONTREAL 2150-32E Avenue Lachine, Quebec, Canada H8T 3H7
P: +1-514-633-1220 F: +1-800-800-2788

VANCOUVER 3353 Wayburne Drive, Burnaby, British Columbia, Canada V5G 4L4
P: +1-877-994-6675 F: +1-800-800-2788

Argentina:

NSK ARGENTINA SRL

BUENOS AIRES Garcia del Rio 2477 Piso 7 Oficina "A" (1429) Buenos Aires-Argentina
P: +54-11-4704-5100 F: +54-11-4704-0033

<As of June 2013>

For the latest information, please refer to the NSK website.
www.nsk.com

NSK Ltd. has a basic policy not to export any products or technology designated as controlled items by export-related laws. When exporting the products in this brochure, the laws of the exporting country must be observed. Specifications are subject to change without notice and without any obligation on the part of the manufacturer. Every care has been taken to ensure the accuracy of the data contained in this brochure, but no liability can be accepted for any loss or damage suffered through errors or omissions. We will gratefully acknowledge any additions or corrections.



NSK used environmentally friendly paper and printing methods for this publication.